



US00D704801S

(12) **United States Design Patent**  
**Chen**

(10) **Patent No.:** **US D704,801 S**

(45) **Date of Patent:** **\*\* May 13, 2014**

(54) **GARDEN SPRAYER**

(56) **References Cited**

(71) Applicant: **Shin Tai Spurt Water of the Garden Tools Co., Ltd.**, Lu-Kang Town (TW)

U.S. PATENT DOCUMENTS

(72) Inventor: **Chin-Yuan Chen**, Lu-Kang Town (TW)

D472,303	S	*	3/2003	Alkalay et al.	.....	D23/223
D502,533	S	*	3/2005	Chen	.....	D23/226
D554,231	S	*	10/2007	Chih	.....	D23/213
D584,381	S	*	1/2009	Hung	.....	D23/223
D691,239	S	*	10/2013	Huang	.....	D23/223

(73) Assignee: **Shin Tai Spurt Water of the Garden Tools Co., Ltd.**, Chang-Hua Hsien (TW)

\* cited by examiner

(\*\*) Term: **14 Years**

*Primary Examiner* — Robin V Webster

(21) Appl. No.: **29/450,345**

(57) **CLAIM**  
The ornamental design for a garden sprayer, as shown and described.

(22) Filed: **Mar. 17, 2013**

**DESCRIPTION**

(51) **LOC (10) Cl.** ..... **23-01**

(52) **U.S. Cl.**  
USPC ..... **D23/223**

(58) **Field of Classification Search**  
USPC ..... D23/213, 223, 226; 239/525–527

FIG. 1 is a perspective view of a garden sprayer showing my new design;  
FIG. 2 is a front elevational view thereof;  
FIG. 3 is a rear elevational view thereof;  
FIG. 4 is a left side elevational view thereof;  
FIG. 5 is a right side elevational view thereof;  
FIG. 6 is a top plan view thereof; and,  
FIG. 7 is a bottom plan view thereof.

See application file for complete search history.

**1 Claim, 4 Drawing Sheets**

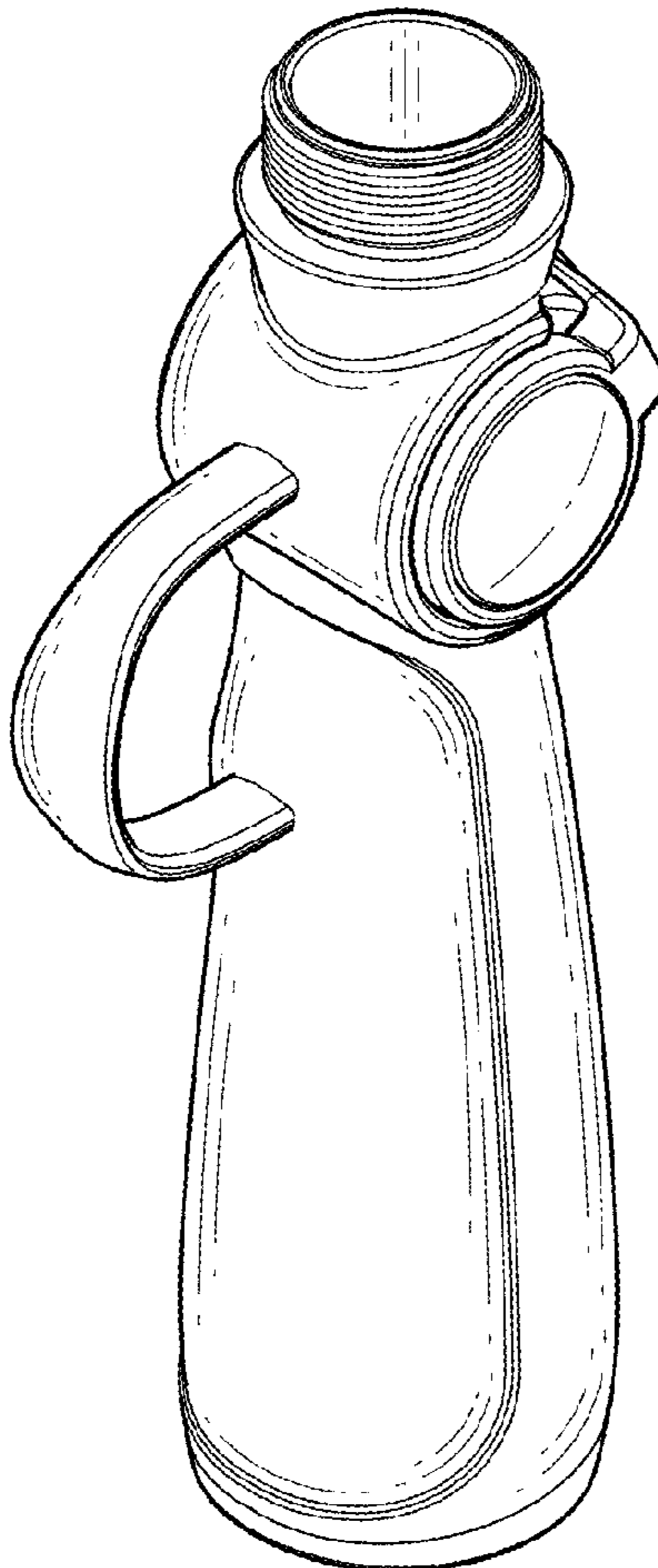

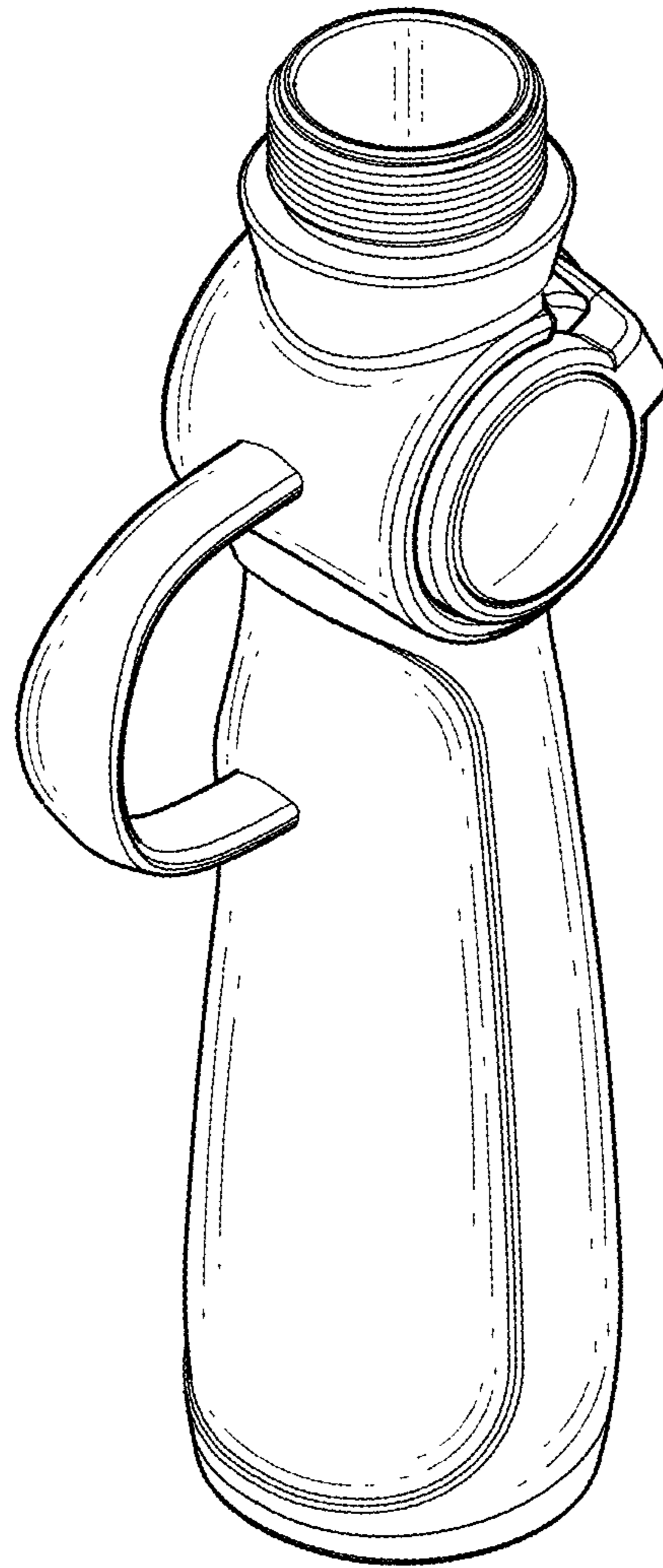

FIG. 1

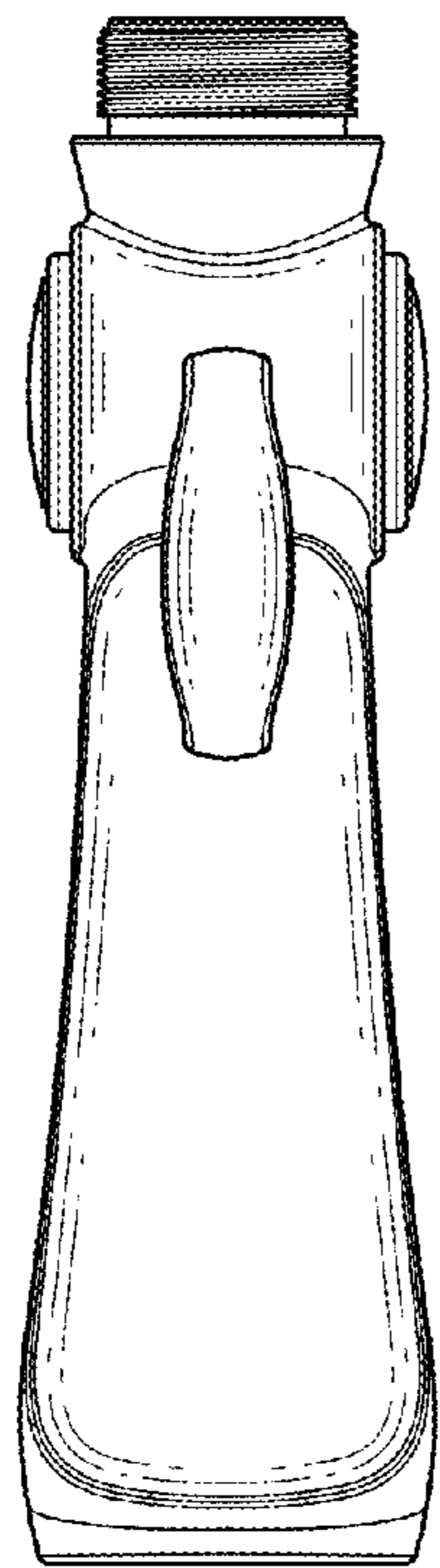

FIG. 2

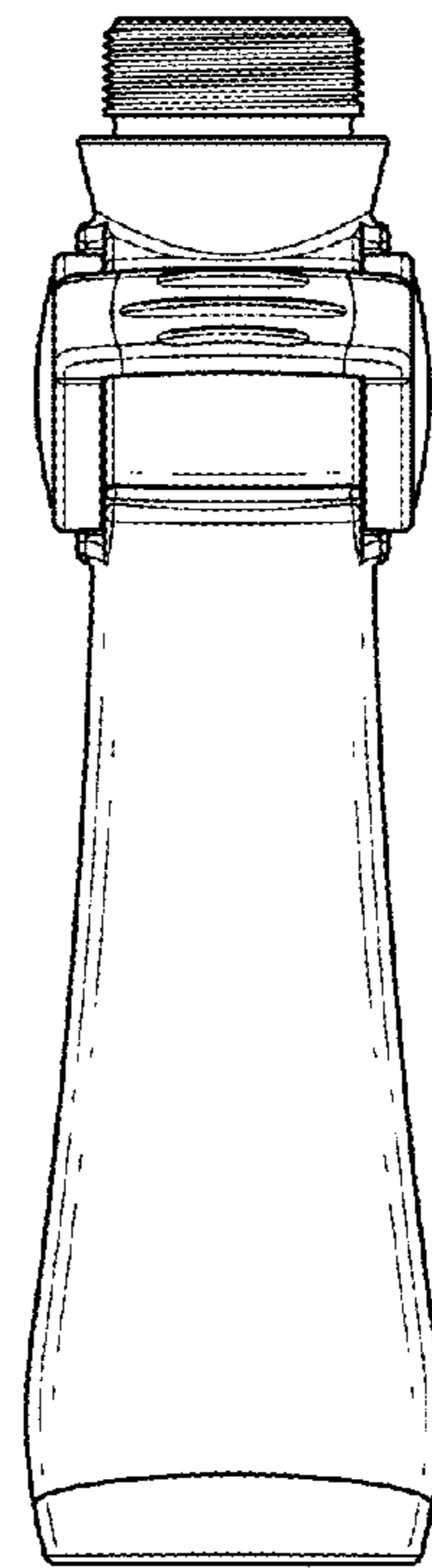

FIG. 3

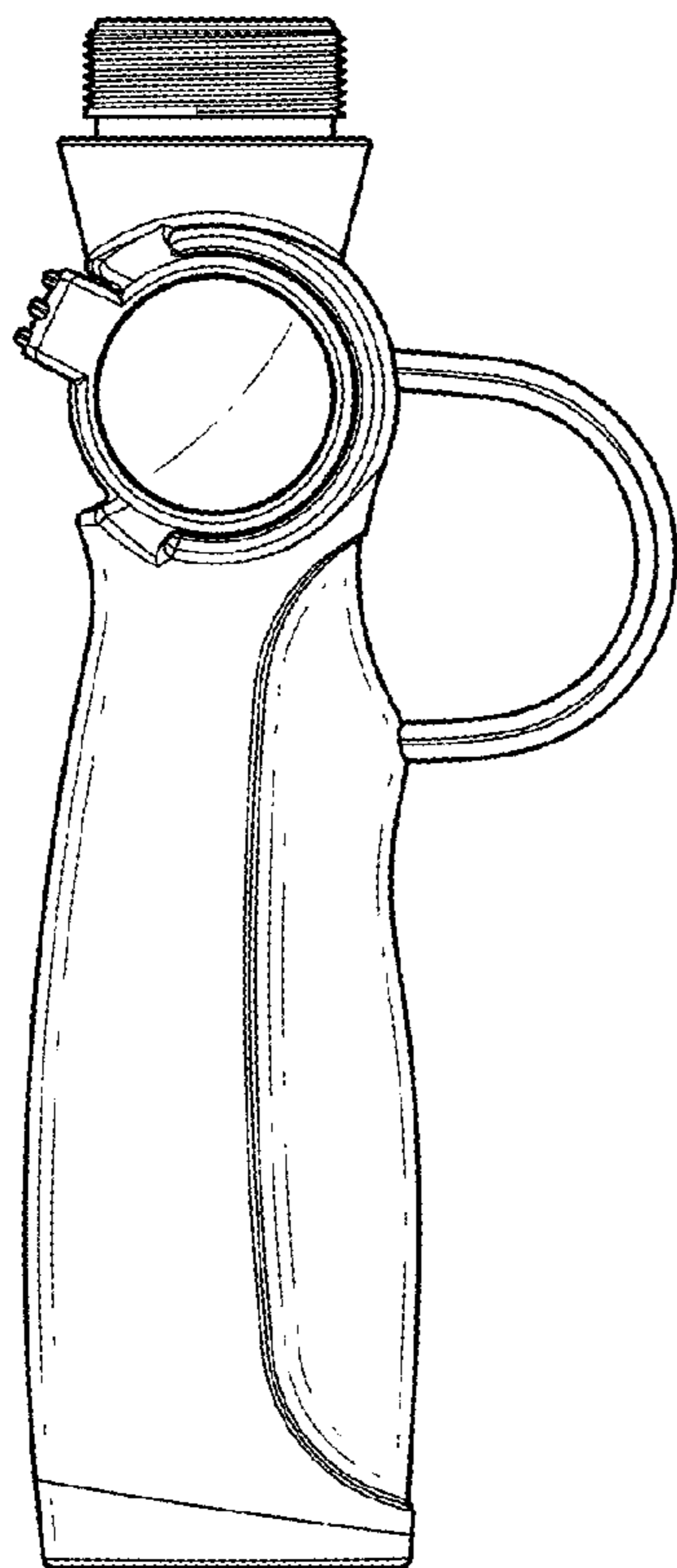

FIG. 4

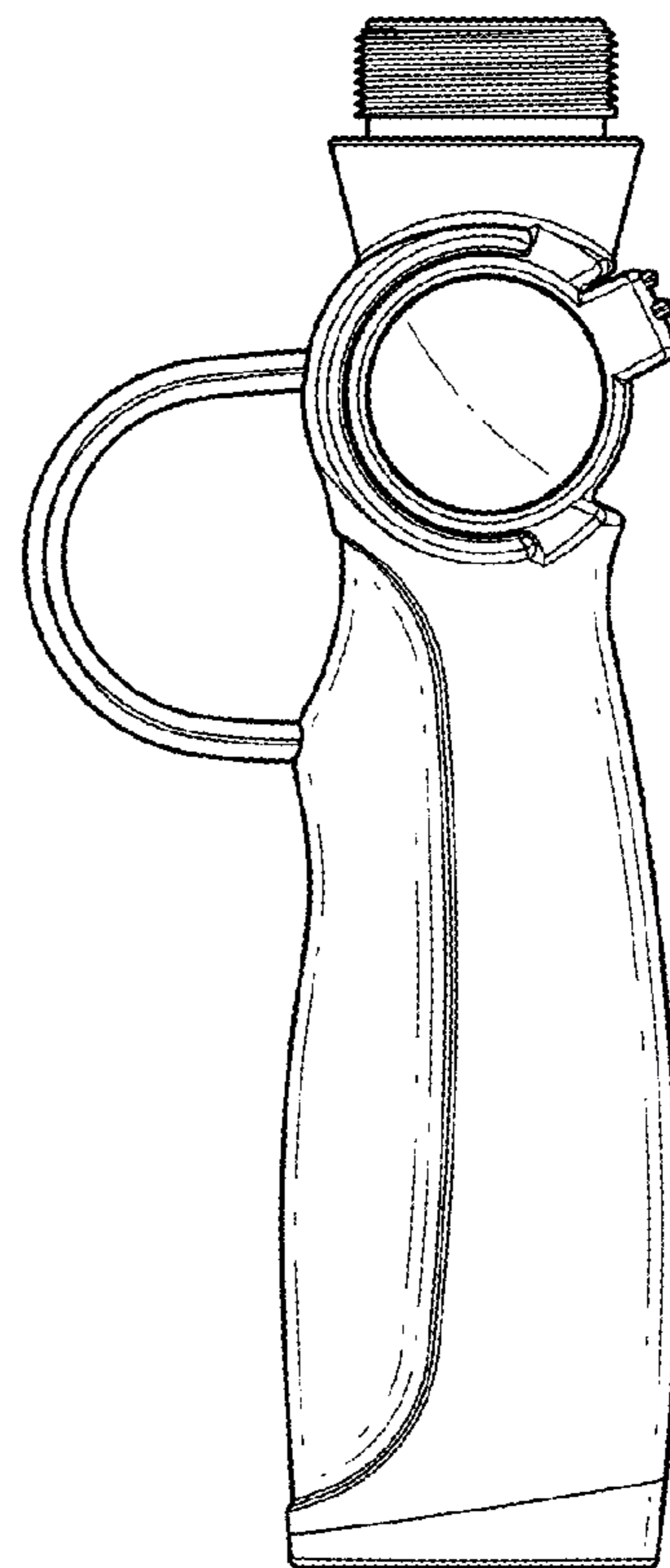

FIG. 5

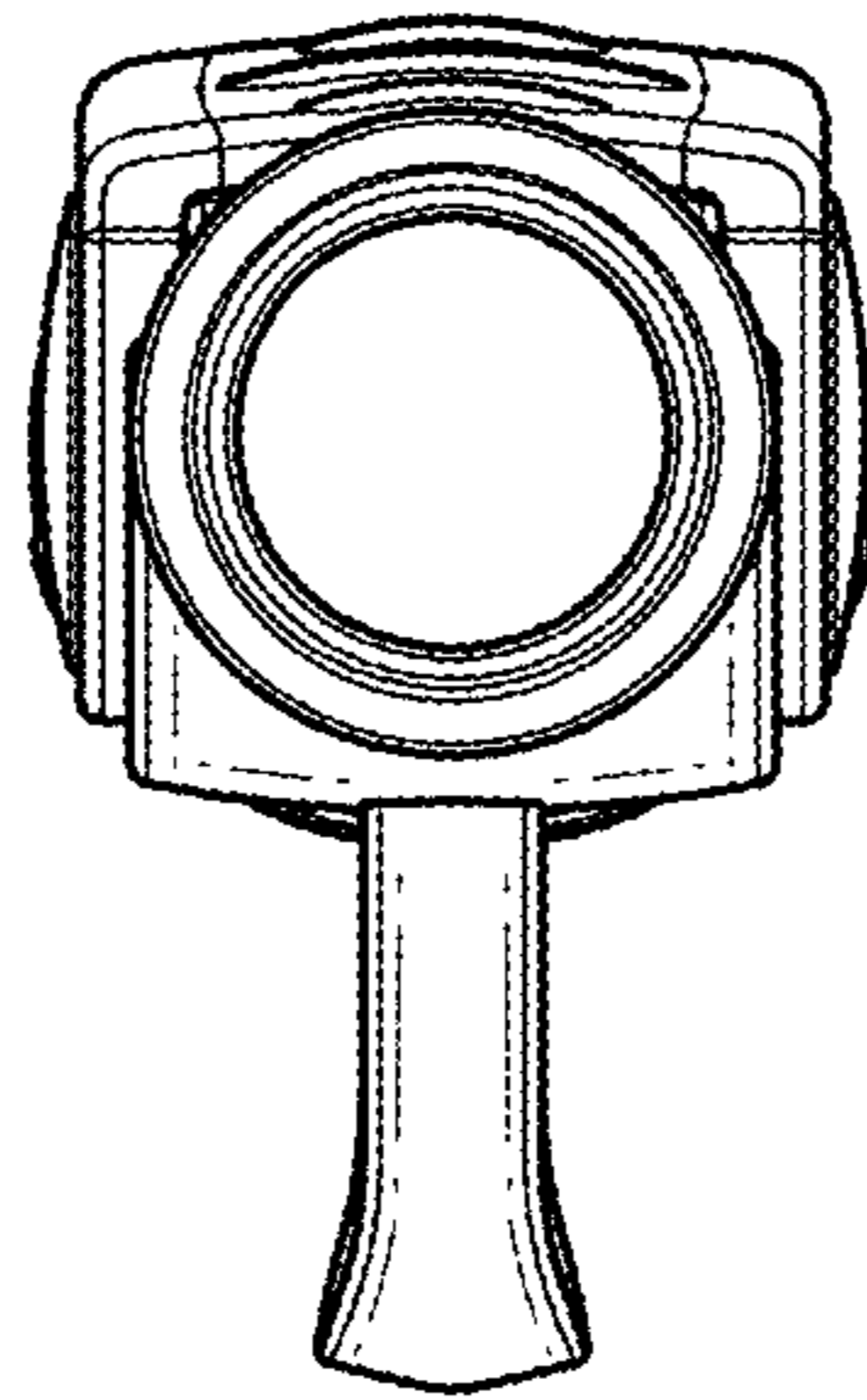

FIG. 6

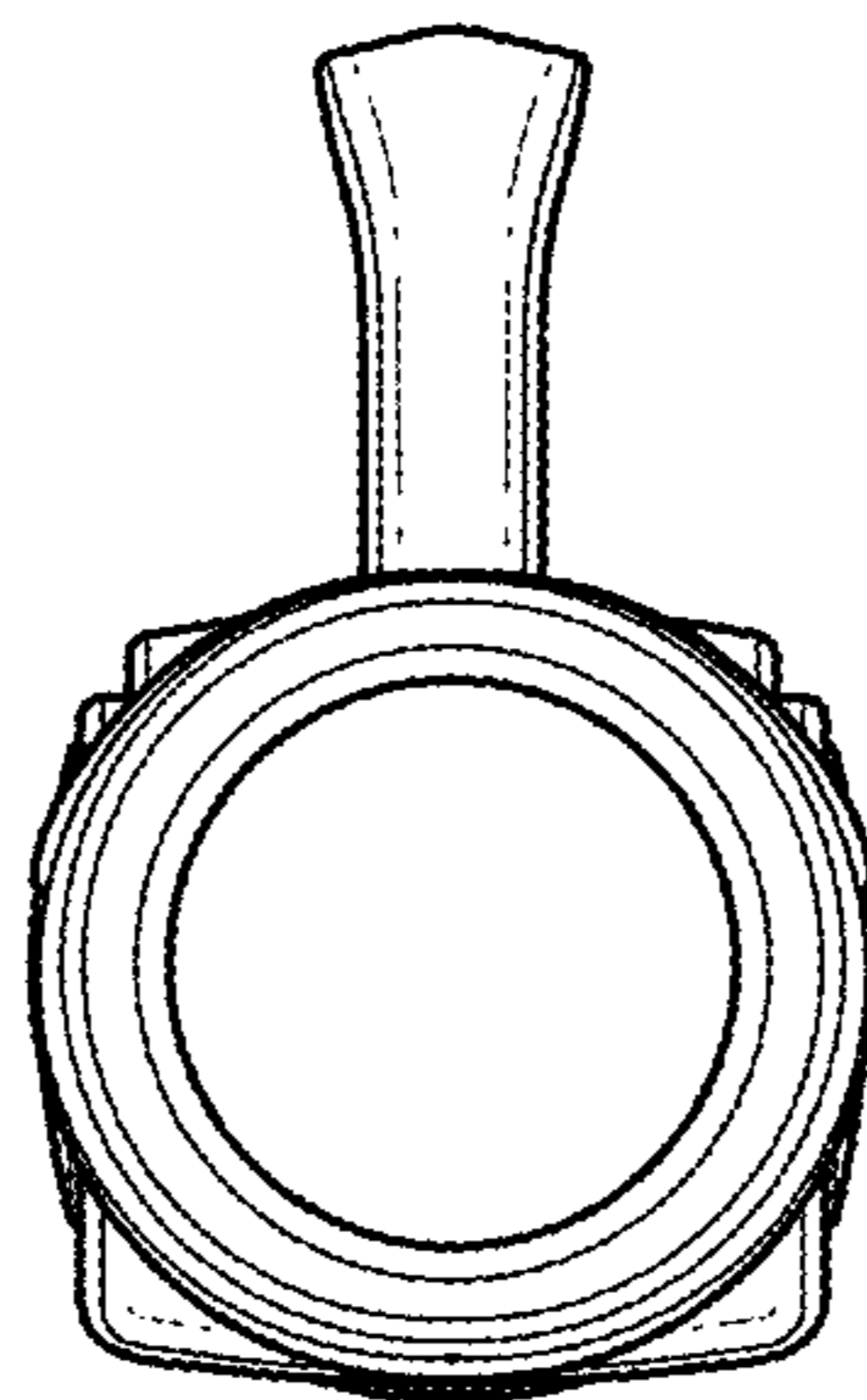

FIG. 7