



US00D704785S

(12) **United States Design Patent**
Feddersen, Jr.

(10) **Patent No.:** **US D704,785 S**

(45) **Date of Patent:** **** May 13, 2014**

(54) **ROPER STYLE COWBOY BOOT ROLLER SKATE**

(71) Applicant: **John Wayne Feddersen, Jr.**, Kopperl, TX (US)

(72) Inventor: **John Wayne Feddersen, Jr.**, Kopperl, TX (US)

(**) Term: **14 Years**

(21) Appl. No.: **29/453,260**

(22) Filed: **Apr. 26, 2013**

(51) **LOC (10) Cl.** **21-02**

(52) **U.S. Cl.**
USPC **D21/763**

(58) **Field of Classification Search**
USPC D21/423, 760, 763, 771, 779;
280/11.14, 11.16, 11.19, 11.209,
280/11.226, 11.233, 11.25, 809, 811;
D2/904, 909, 910

See application file for complete search history.

(56) **References Cited**

U.S. PATENT DOCUMENTS

3,387,852	A *	6/1968	De Sarro	280/11.209
3,843,146	A *	10/1974	Hiraki	280/11.209
4,061,348	A	12/1977	Carter		
D253,496	S *	11/1979	Douglas	D2/910
D360,448	S *	7/1995	Wing, Jr.	D21/764
D388,145	S *	12/1997	Lee	D21/763
D404,078	S *	1/1999	Meibock et al.	D21/763

5,956,867	A	9/1999	Harton		
D414,916	S *	10/1999	Rench et al.	D2/904
D427,752	S *	7/2000	Coffman et al.	D2/906
D482,750	S *	11/2003	Magerer et al.	D21/763
D525,016	S *	7/2006	Feller	D2/909
D595,798	S *	7/2009	Collins	D21/763
D638,214	S *	5/2011	Blakeslee	D2/970

* cited by examiner

Primary Examiner — Cynthia M Chin

(74) *Attorney, Agent, or Firm* — Daniel Boudwin; Global Intellectual Property Agency LLC

(57) **CLAIM**

The ornamental design for a roper style cowboy boot roller skate, as shown and described.

DESCRIPTION

FIG. 1 shows an overhead perspective view of the cowboy boot skate.

FIG. 2 shows a right side view of the cowboy boot roller skate

FIG. 3 shows a left side view of the cowboy boot roller skate

FIG. 4 shows a bottom view of the cowboy boot roller skate, showing the skate plate and wheel portion.

FIG. 5 shows a top view of the cowboy boot roller skate, showing the boot interior.

FIG. 6 shows a front view of the cowboy boot roller skate, showing the toe, stopper and front wheels; and,

FIG. 7 shows a back view of the cowboy boot roller skate, showing the rear wheels.

The broken lines represent portions of the article that form no part of the claim.

1 Claim, 5 Drawing Sheets

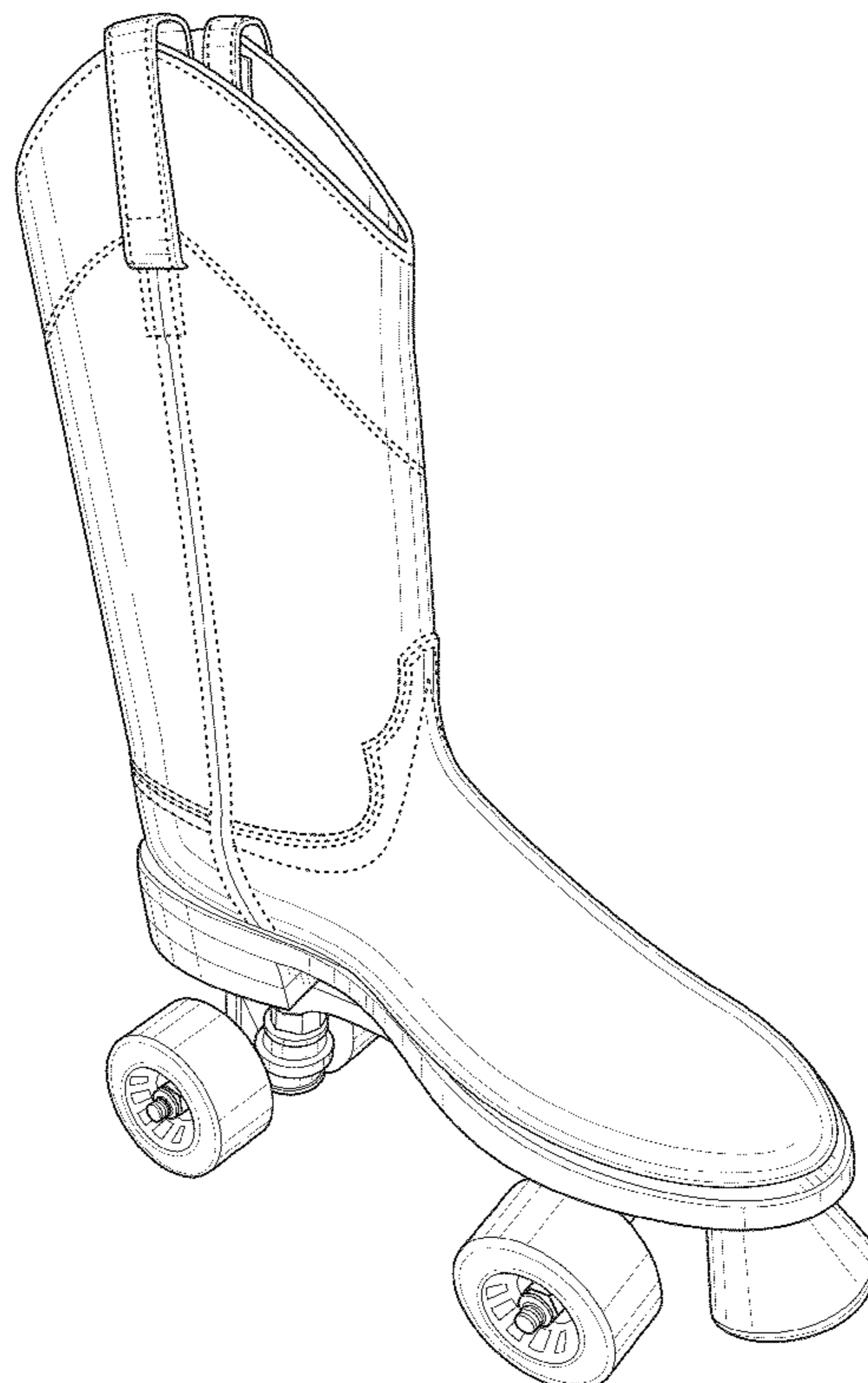

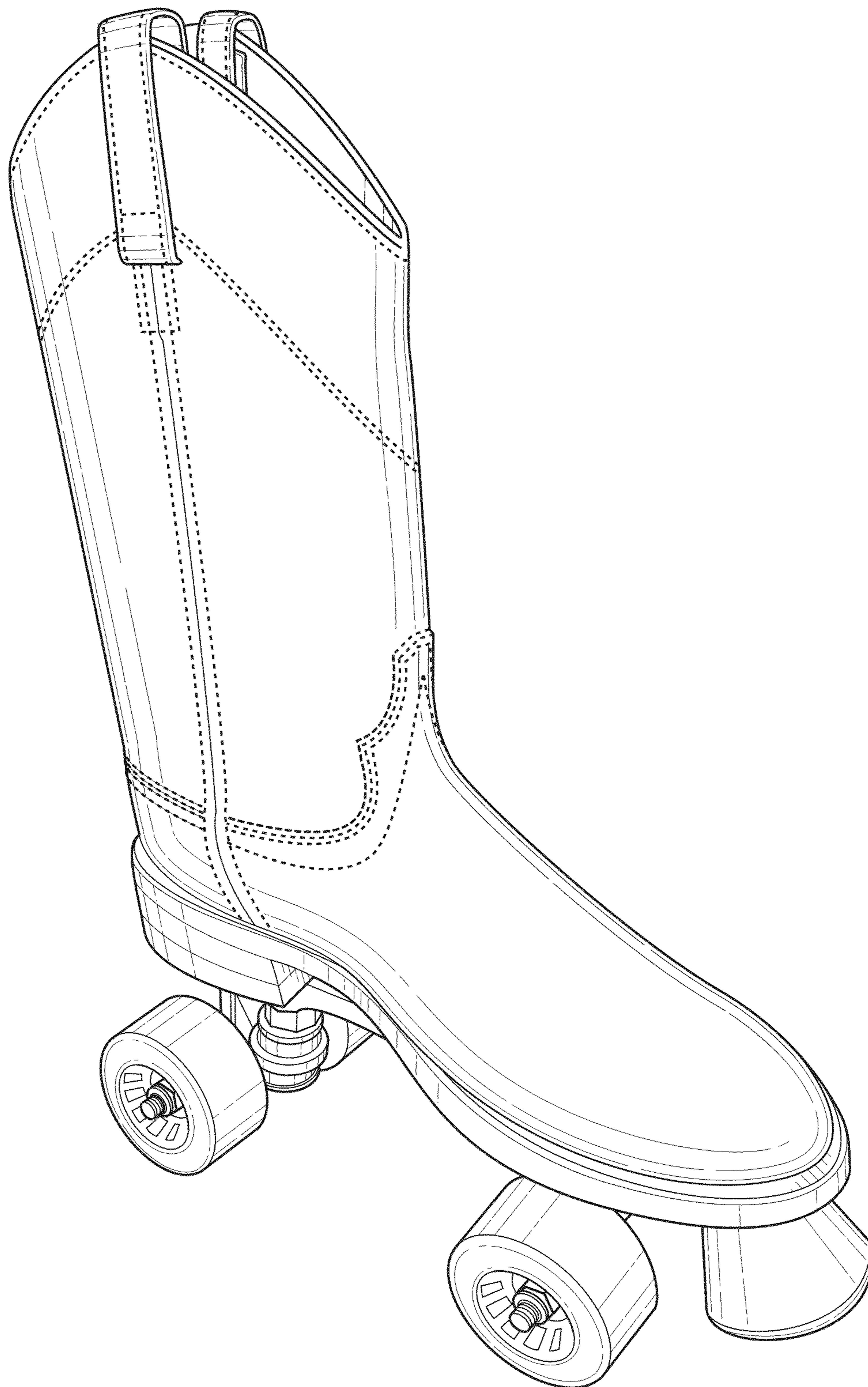

FIG. 1

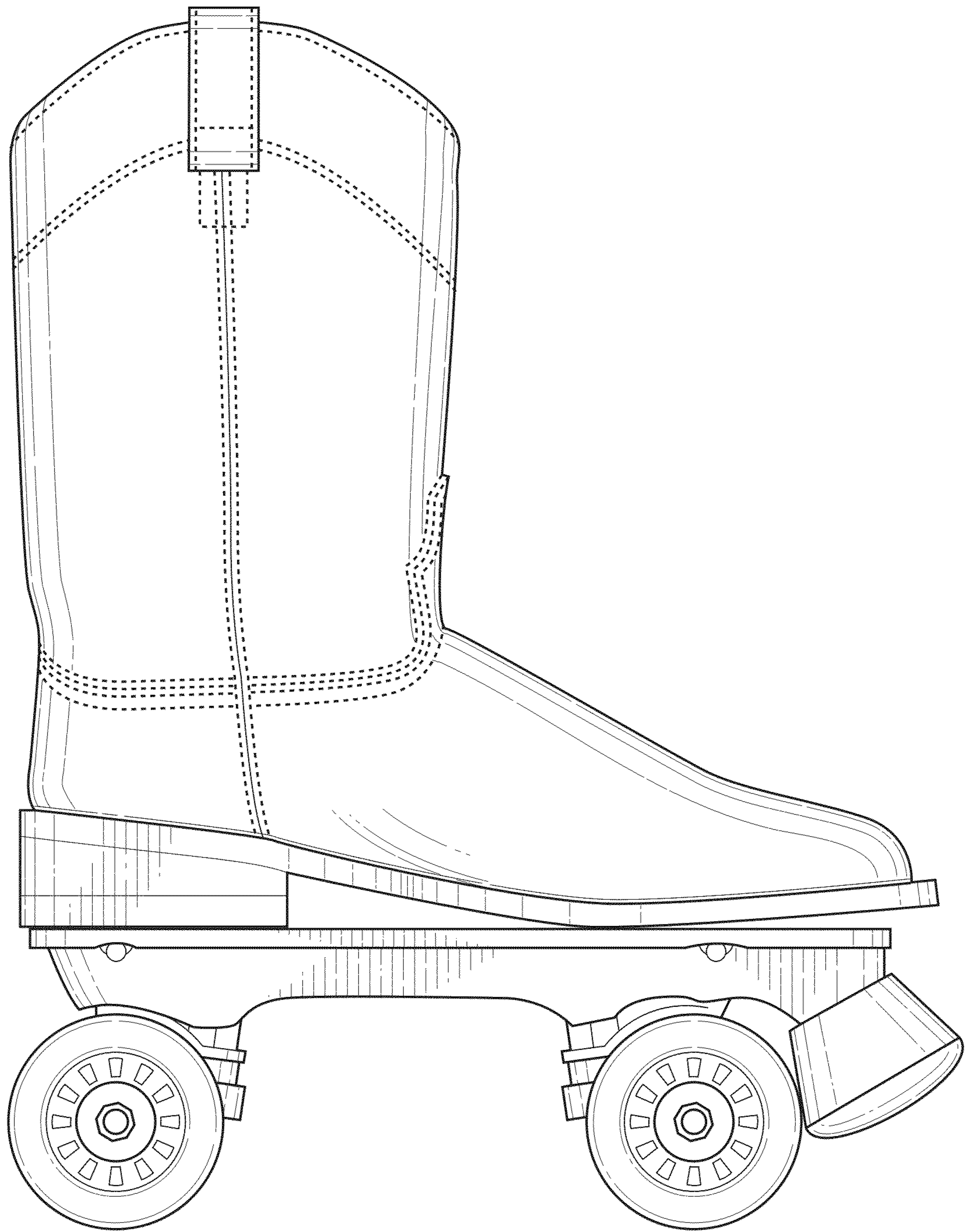

FIG. 2



FIG. 3

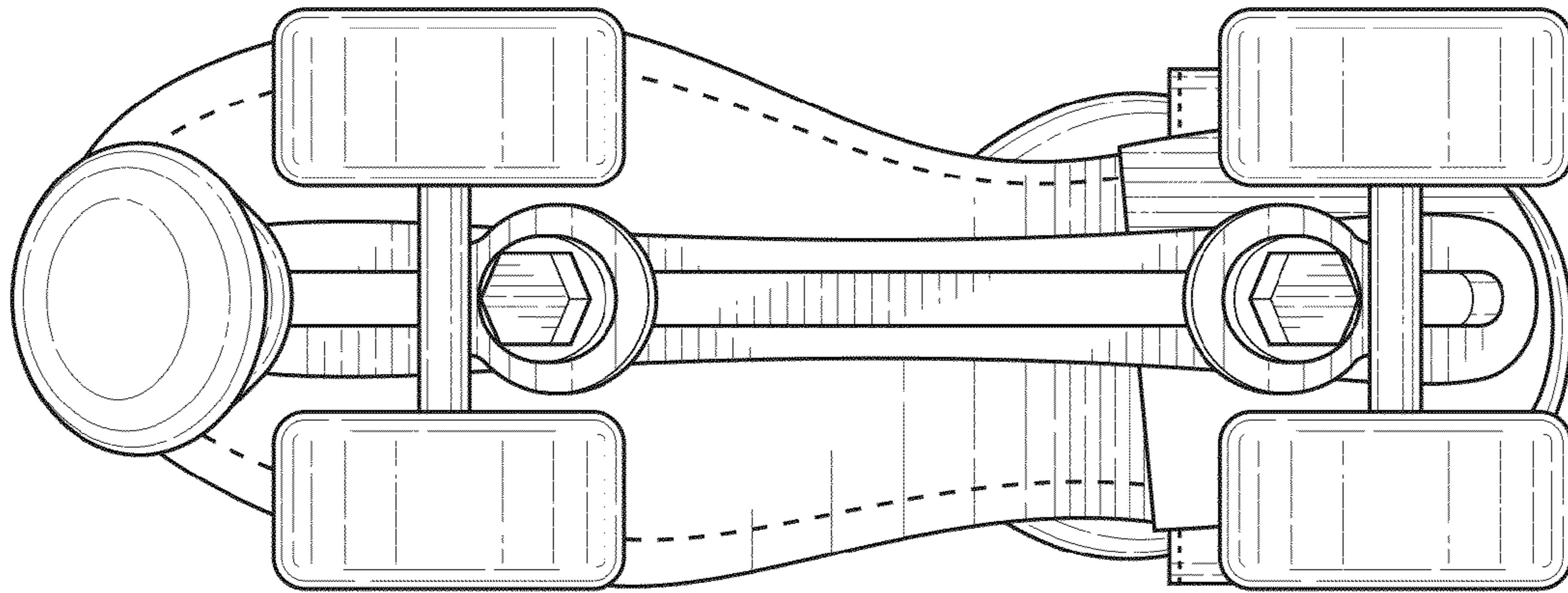

FIG. 4

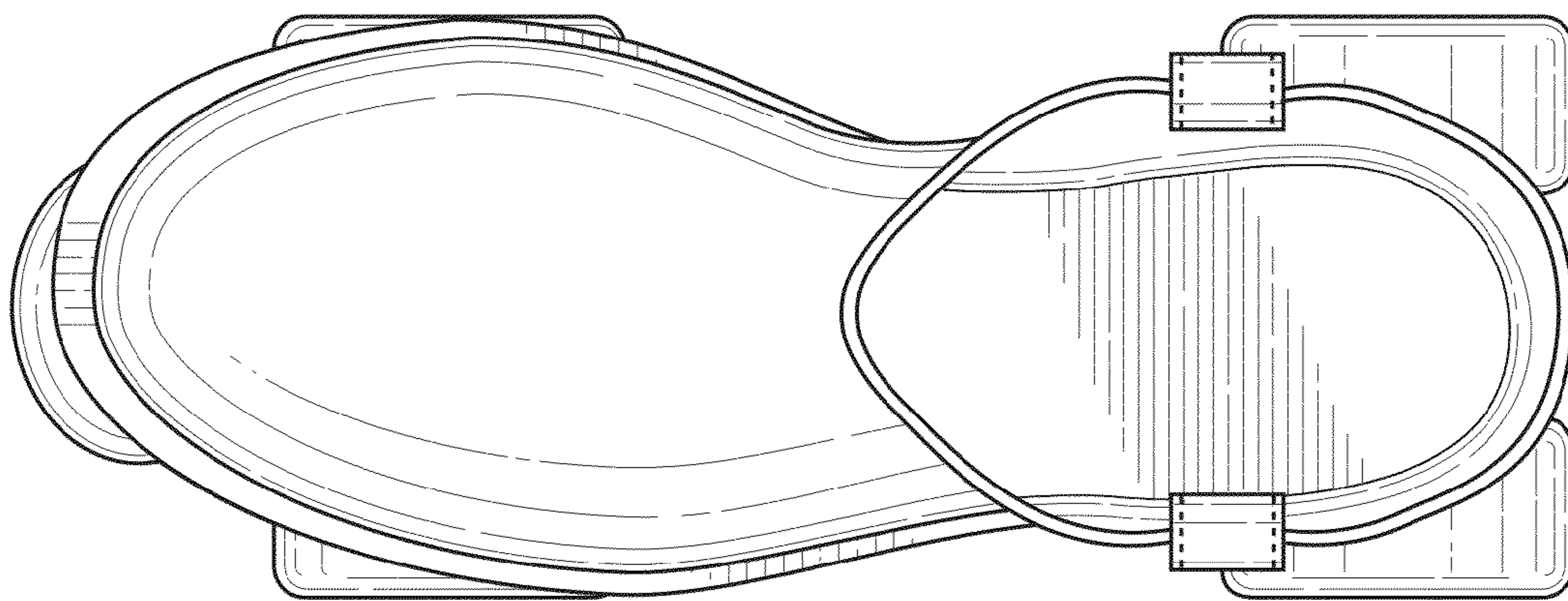

FIG. 5

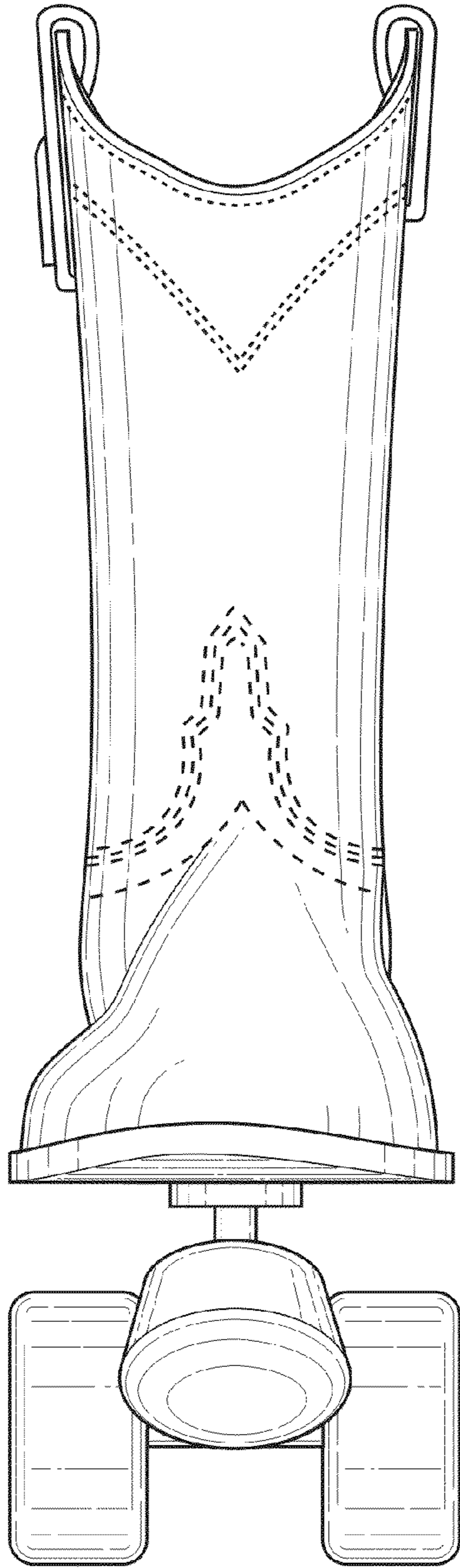

FIG. 6

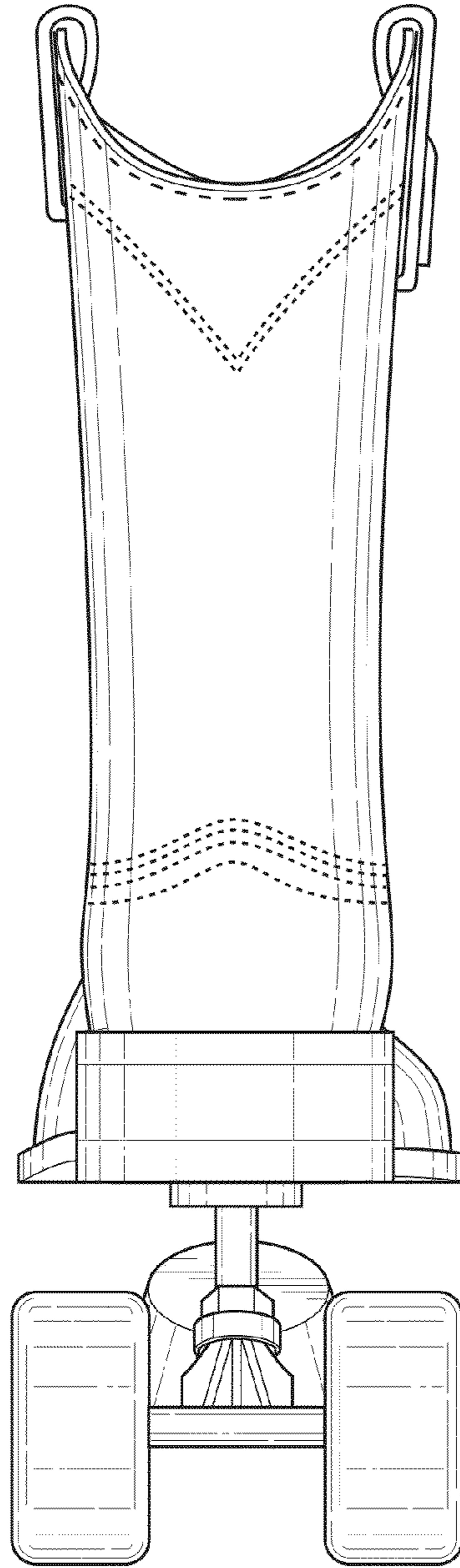

FIG. 7