



US00D704765S

(12) **United States Design Patent**
Markovitz et al.

(10) **Patent No.:** **US D704,765 S**

(45) **Date of Patent:** **** May 13, 2014**

- (54) **EYEGLASSES**
- (71) Applicants: **Aaron Markovitz**, New York, NY (US);
Artiss Akarra, Johnston, RI (US)
- (72) Inventors: **Aaron Markovitz**, New York, NY (US);
Artiss Akarra, Johnston, RI (US)
- (73) Assignee: **Cross Optical Group, Inc.**, Daytona
Beach, FL (US)
- (**) Term: **14 Years**
- (21) Appl. No.: **29/453,364**
- (22) Filed: **Apr. 29, 2013**
- (51) **LOC (10) Cl.** **16-06**
- (52) **U.S. Cl.**
USPC **D16/320**
- (58) **Field of Classification Search**
USPC D16/101, 300–342, 900; D29/109–110;
351/41, 44, 51–52, 62, 158, 92,
351/103–123, 140–153, 45–46; 2/426–432,
2/447–449, 441, 434–437, 13, 15;
D21/483, 659–661; D14/372
See application file for complete search history.

- 2,781,693 A 2/1957 Brumby
- D185,987 S 8/1959 Marfuggi
- D187,752 S 4/1960 Lindblom
- D192,884 S 5/1962 Petitto
- D193,028 S 6/1962 Petitto
- 3,052,160 A 9/1962 Ratti
- D202,658 S 10/1965 Petitto
- D204,812 S 5/1966 Schindler
- D207,028 S 2/1967 Griss
- D209,861 S 1/1968 Demmel
- D209,862 S 1/1968 McCracken
- D210,697 S 4/1968 Ramp
- D210,698 S 4/1968 Simon
- 3,395,406 A 8/1968 Smith
- D213,595 S 3/1969 Simon
- D216,563 S 2/1970 Ramp
- D218,128 S 7/1970 Bloch
- D218,953 S 10/1970 Maiese
- D220,289 S 3/1971 Mitchell

(Continued)

OTHER PUBLICATIONS

Fathom, GlassMirror Lens. Costa Del Mar. Downloaded Dec. 7, 2006
at <http://www.eyeglasses.com/product/1091472073-1091472073>.

(Continued)

Primary Examiner — Raphael Barkai
(74) *Attorney, Agent, or Firm* — Malloy & Malloy, P.L.

(56) **References Cited**

U.S. PATENT DOCUMENTS

- D84,596 S 2/1931 Rohman
- D135,992 S * 7/1943 Pomeranz D16/320
- 2,403,223 A 7/1946 Kaesz
- D146,004 S 12/1946 Jacobson
- D146,602 S 4/1947 Jaffe
- D149,312 S 4/1948 Schwartz
- D151,070 S 9/1948 Rohman
- D151,222 S 10/1948 Ditto
- 2,482,195 A 9/1949 Martin
- D155,580 S 10/1949 Coen
- D170,745 S 11/1953 Carmichael
- D173,868 S 1/1955 Belgard
- 2,749,800 A 6/1956 Gagnon

(57) **CLAIM**

The ornamental design for eyeglasses, as shown and described.

DESCRIPTION

FIG. 1 is a front view illustrating our design for eyeglasses;
FIG. 2 is a top plan view thereof;
FIG. 3 is a left side view thereof; the right side being a mirror
image thereof;
FIG. 4 is a front perspective view thereof;
FIG. 5 is a rear view thereof; and,
FIG. 6 is a bottom view thereof.

1 Claim, 6 Drawing Sheets

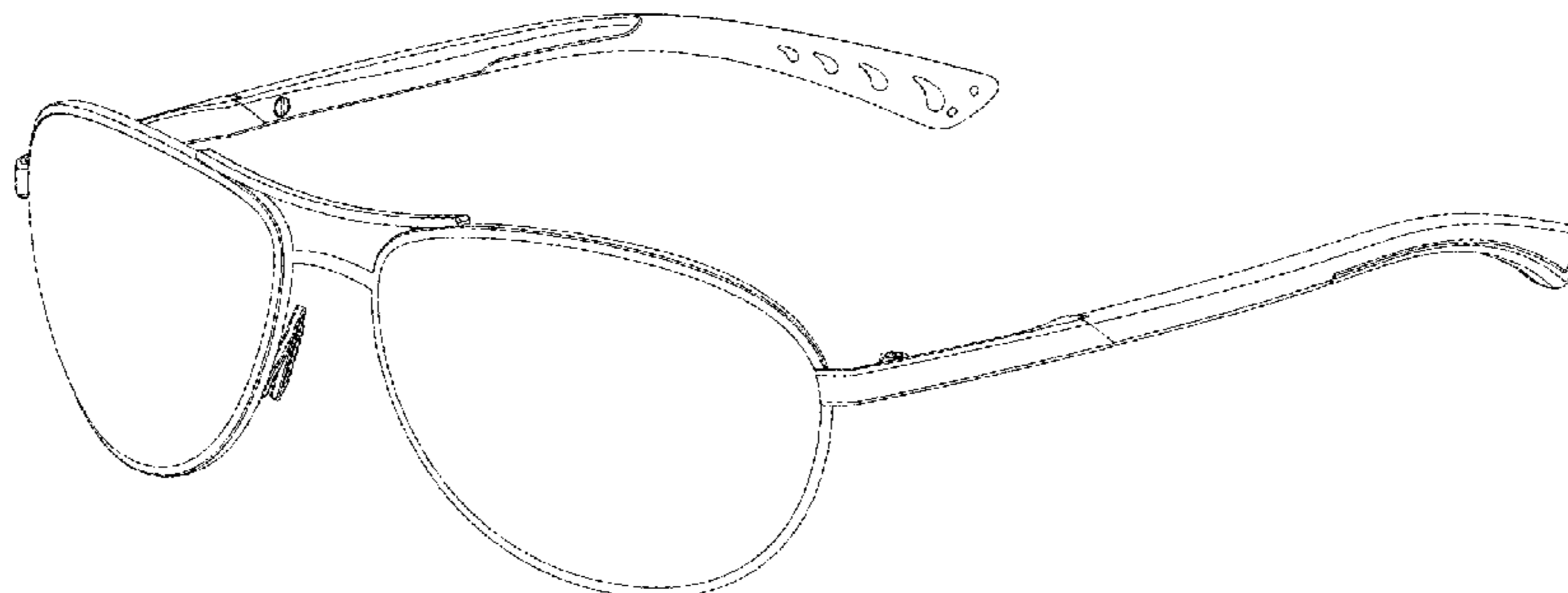

(56)

References Cited

U.S. PATENT DOCUMENTS

D220,291 S	3/1971	Leominster	D429,754 S	8/2000	Markovitz et al.
D227,405 S	6/1973	Shindler	D434,064 S	11/2000	Lane
D232,380 S	8/1974	Johnsen	D434,789 S	12/2000	Lane
D243,084 S	1/1977	Johnsen	6,168,271 B1	1/2001	Houston et al.
4,222,640 A	9/1980	Bononi	D437,871 S	2/2001	Tortorella
D263,058 S	2/1982	Johnsen	D441,002 S	4/2001	Stark et al.
4,345,824 A	8/1982	Daubignard	6,233,342 B1	5/2001	Fernandez
D275,204 S	8/1984	Kanoûi	D445,821 S	7/2001	Agnoli
4,470,674 A	9/1984	Piampiano	6,253,388 B1	7/2001	Lando
D276,349 S	11/1984	Zeni	6,264,327 B1	7/2001	Copeland
D282,668 S	2/1986	Haas	D447,763 S	9/2001	Lane
D285,020 S	8/1986	Schmidthaler	D449,640 S	10/2001	Grundy
4,665,598 A	5/1987	Murai et al.	D449,641 S	10/2001	Arnette
D290,465 S	6/1987	Levoy	D450,744 S	11/2001	Rhoades et al.
D300,226 S	3/1989	Ramp	D451,120 S	11/2001	Venezia
D302,559 S	8/1989	Samuel	D452,522 S	12/2001	Chiou
D314,779 S	2/1991	Ramp	D453,024 S	1/2002	Bonnemere
D321,523 S	11/1991	Cherian	6,334,680 B1	1/2002	Larson
D324,394 S	3/1992	Jannard	D453,783 S	2/2002	Ho
5,343,259 A	8/1994	Nakanishi	D455,168 S	4/2002	Bonnemere
5,373,331 A	12/1994	Vallalla et al.	D456,038 S	4/2002	Arnette
5,423,092 A	6/1995	Kawai	D456,441 S	4/2002	Jannard et al.
D369,375 S	4/1996	Jannard et al.	D463,815 S	10/2002	Katz et al.
D369,376 S	4/1996	Guo	D464,669 S	10/2002	Thixton et al.
D371,384 S	7/1996	Bonnemere	D469,459 S	1/2003	Moritz
5,541,674 A	7/1996	Jannard et al.	D470,167 S	2/2003	Jannard et al.
D372,929 S	8/1996	Conway	D470,883 S	2/2003	Teng
D376,810 S	12/1996	Ohie	D472,915 S	4/2003	Rohrbach et al.
D377,037 S	12/1996	Stolt	D474,224 S	5/2003	Chen
5,608,469 A	3/1997	Bollé	6,561,647 B1	5/2003	Chen
D380,487 S	7/1997	Nevitt	D475,390 S	6/2003	Wang-Lee
D382,291 S	8/1997	Wilson	D475,733 S	6/2003	Lee
D382,892 S	8/1997	Murai	D476,354 S	6/2003	Chen
D383,478 S	9/1997	Wilson	D477,348 S	7/2003	Lane
D385,291 S	10/1997	Jannard et al.	6,604,824 B2	8/2003	Larson
D385,897 S	11/1997	Lin	D481,059 S	10/2003	Egbert et al.
D391,596 S	3/1998	Simioni	6,637,877 B1	10/2003	Hartley et al.
D393,653 S	4/1998	Howard, IV	D481,750 S	11/2003	Stables
D394,871 S	6/1998	Simioni	D481,751 S	11/2003	Stables
5,764,333 A	6/1998	Somsel	D483,393 S	12/2003	Chen
5,768,716 A	6/1998	Porsche	D487,477 S	3/2004	Lane
D397,350 S	8/1998	Jannard et al.	D488,499 S	4/2004	Mage
D397,712 S	9/1998	Simioni	6,715,873 B2	4/2004	Nahmias
D398,022 S	9/1998	Jannard et al.	6,729,725 B1	5/2004	Cheng
D398,330 S	9/1998	Lin	D493,188 S	7/2004	Brueck
5,815,235 A	9/1998	Runckel	6,767,095 B1	7/2004	Altelaar et al.
D399,238 S	10/1998	Simioni	6,783,235 B1	8/2004	Lin
D399,866 S	10/1998	Yee	D496,064 S	9/2004	Mangum
D401,610 S	11/1998	Flanagan	D500,781 S	1/2005	Mage
D404,754 S	1/1999	Yee et al.	D501,218 S	1/2005	Teng
D407,099 S	3/1999	Wang	6,863,395 B1	3/2005	Teng
D407,427 S	3/1999	Matera	D503,949 S	4/2005	Teng
D408,839 S	4/1999	Matera	D508,514 S	8/2005	Hester
D408,841 S	4/1999	Conway	D508,515 S	8/2005	Yee et al.
D409,224 S	5/1999	Matera	D513,518 S	1/2006	Stables
D410,022 S	5/1999	Conway	D514,615 S	2/2006	Mangum
5,903,331 A	5/1999	Lin	D515,617 S	2/2006	Stables
D412,008 S	7/1999	Hall et al.	D515,618 S	2/2006	Stables
D413,137 S	8/1999	Lin	D518,502 S	4/2006	Teng
D414,796 S	10/1999	Amette	D519,146 S	4/2006	Yasuhara
5,963,296 A	10/1999	Matera	D519,148 S	4/2006	Wu
D420,035 S	2/2000	Hartman	7,036,927 B2	5/2006	Kopfer
D422,005 S	3/2000	Martinant de Preneuf	D525,278 S	7/2006	Krefman
D423,034 S	4/2000	Arnette	D532,438 S	11/2006	Yang
D423,550 S	4/2000	Matera	D533,892 S	12/2006	Moody et al.
D423,551 S	4/2000	Lamy	7,150,525 B1	12/2006	Yang
D424,094 S	5/2000	Conway	D534,569 S	1/2007	Teng
D424,598 S	5/2000	Simioni	D534,573 S	1/2007	Mage
D425,102 S	5/2000	Matera	D534,942 S	1/2007	Lynch
D425,103 S	5/2000	Yee et al.	D535,316 S	1/2007	Teng
6,056,399 A	5/2000	Jannard et al.	D535,317 S	1/2007	Wolfe
D426,567 S	6/2000	Gugler	D535,682 S	1/2007	Paulson
D427,227 S	6/2000	Conway	D536,028 S	1/2007	Paulson
D427,622 S	7/2000	Conway	D537,861 S	3/2007	Teng
D428,907 S	8/2000	Matera	D537,863 S	3/2007	Markovitz et al.
			D538,326 S	3/2007	Guo
			D539,330 S	3/2007	Hester
			D539,829 S	4/2007	Chuang
			D539,834 S	4/2007	Hester

(56)

References Cited

U.S. PATENT DOCUMENTS

D540,370 S	4/2007	Sheldon	D582,960 S	12/2008	Fuchs
D540,846 S	4/2007	Sheldon	D582,966 S	12/2008	Serlenga
D541,839 S	5/2007	Sheldon	D583,403 S	12/2008	Lane et al.
D542,330 S	5/2007	Elmore	D583,404 S	12/2008	Baden et al.
D543,572 S	5/2007	Yee et al.	D583,852 S	12/2008	Chen
D544,018 S	6/2007	Huang	D583,853 S	12/2008	Markovitz et al.
D544,521 S	6/2007	Lee	D584,330 S	1/2009	Chen
D545,348 S	6/2007	Chen et al.	D584,332 S	1/2009	Moody
D545,871 S	7/2007	Yee	D584,758 S	1/2009	Mage
D545,872 S	7/2007	Yee et al.	D584,759 S	1/2009	Yang
D545,873 S	7/2007	Sheldon	D585,474 S	1/2009	Tu
D546,867 S	7/2007	Teng	D585,475 S	1/2009	Yang
D547,355 S	7/2007	Fuchs	7,481,529 B1	1/2009	Chen
D547,794 S	7/2007	Jannard et al.	D585,928 S	2/2009	Markovitz
D548,268 S	8/2007	Yee	D586,379 S	2/2009	Thixton et al.
D548,269 S	8/2007	Baden et al.	D586,380 S	2/2009	Yee
D548,769 S	8/2007	Chen et al.	D587,740 S	3/2009	Friedman
D549,268 S	8/2007	Daems et al.	D588,183 S	3/2009	Friedman
D549,746 S	8/2007	Popov	D588,626 S	3/2009	Markovitz
D549,763 S	8/2007	Daems et al.	D589,079 S	3/2009	Markovitz et al.
D549,764 S	8/2007	Teng	D590,433 S	4/2009	Lane et al.
D550,272 S	9/2007	Markovitz	D590,869 S	4/2009	Yang
D550,753 S	9/2007	Li et al.	D591,789 S	5/2009	Li
D550,755 S	9/2007	Fuchs	D594,052 S	6/2009	Yang
D550,757 S	9/2007	Li et al.	D595,333 S	6/2009	Markovitz et al.
D552,155 S	10/2007	Markovitz	D597,124 S	7/2009	Markovitz
D552,665 S	10/2007	Mage	D599,837 S	9/2009	Markovitz et al.
D553,177 S	10/2007	Chen et al.	D599,838 S	9/2009	Rohrbach
D553,663 S	10/2007	Moody	D599,840 S	9/2009	Daems et al.
D554,687 S	11/2007	Arnette	D600,271 S	9/2009	Markovitz et al.
D554,689 S	11/2007	Jannard et al.	D601,181 S	9/2009	Fuchs
D555,705 S	11/2007	Chuang	D601,613 S	10/2009	Yee
D556,243 S	11/2007	Elmore	D601,615 S	10/2009	Mage
D556,245 S	11/2007	Lane	D602,975 S	10/2009	Fuchs
D556,246 S	11/2007	Yee et al.	D602,977 S	10/2009	Falvo
D556,248 S	11/2007	Elmore	D603,446 S	11/2009	Moody
D556,813 S	12/2007	Brück	D603,447 S	11/2009	Markovitz et al.
D557,324 S	12/2007	Moody	D603,448 S	11/2009	Markovitz
D557,325 S	12/2007	Janard et al.	D605,686 S	12/2009	Yasuhara
D557,730 S	12/2007	Mage	D606,112 S	12/2009	Markovitz et al.
D557,731 S	12/2007	Mage	D606,575 S	12/2009	Markovitz et al.
D558,816 S	1/2008	Yee	D606,578 S	12/2009	Markovitz et al.
D559,301 S	1/2008	Elmore	D606,580 S	12/2009	Markovitz et al.
D559,888 S	1/2008	Yang	D607,039 S	12/2009	Yee
D561,809 S	2/2008	Yee	D607,918 S	1/2010	Khubani
D561,810 S	2/2008	Fox et al.	7,648,233 B2	1/2010	Blanshay et al.
D561,812 S	2/2008	Fox et al.	D610,604 S	2/2010	Thixton
D561,813 S	2/2008	Baden et al.	D613,788 S	4/2010	Friedman
D561,814 S	2/2008	Thixton et al.	D614,359 S	4/2010	Gleason et al.
D563,455 S	3/2008	Markovitz et al.	D615,579 S	5/2010	Markovitz
D564,569 S	3/2008	Mage	D616,013 S	5/2010	Reed
D564,570 S	3/2008	Mage	D616,014 S	5/2010	Yang
D564,571 S	3/2008	Jannard et al.	D616,015 S	5/2010	Markovitz et al.
D565,085 S	3/2008	Mage	D616,016 S	5/2010	Markovitz et al.
D565,087 S	3/2008	Yee et al.	D616,918 S *	6/2010	Rohrbach D16/320
D565,090 S	3/2008	Yee	D616,919 S	6/2010	Thixton
D567,838 S	4/2008	Fuchs	D617,365 S	6/2010	Akara et al.
D568,365 S	5/2008	Fuchs	D617,366 S	6/2010	Fulton
D568,369 S	5/2008	Della Valle	D619,160 S	7/2010	Sheldon
D568,371 S	5/2008	Chen	D621,438 S	8/2010	Markovitz et al.
D568,921 S	5/2008	Anderl	D621,868 S	8/2010	Gonzalez
D568,924 S	5/2008	Markovitz	D622,302 S	8/2010	Yee
D570,900 S	6/2008	Markovitz	D622,757 S	8/2010	Mouclier
D572,294 S	7/2008	Markovitz	D623,216 S	9/2010	Rohrbach
D572,747 S	7/2008	Baden et al.	D623,217 S	9/2010	Markovitz et al.
D572,748 S	7/2008	Markovitz	D623,683 S	9/2010	Rohrbach
D575,323 S	8/2008	Jannard et al.	D623,684 S	9/2010	Yee
D575,813 S	8/2008	Li	D626,988 S	11/2010	Yang
D577,759 S	9/2008	Yee	D626,990 S	11/2010	Markovitz
D580,475 S	11/2008	Markovitz et al.	D628,229 S	11/2010	Fuchs
D581,443 S	11/2008	Jannard et al.	D629,036 S	12/2010	Yee et al.
D581,444 S	11/2008	Jannard et al.	D629,443 S	12/2010	Markovitz et al.
D581,449 S	11/2008	Yee et al.	D629,444 S	12/2010	Markovitz et al.
D581,450 S	11/2008	Moritz	D629,829 S	12/2010	Akara et al.
D581,966 S	12/2008	Serlenga	D629,830 S	12/2010	Markovitz et al.
			D629,831 S	12/2010	Markovitz
			7,856,673 B2	12/2010	Reed
			D630,674 S	1/2011	Markovitz
			D631,084 S	1/2011	Phillips

(56)

References Cited

U.S. PATENT DOCUMENTS

D632,721 S 2/2011 Chou
 D633,129 S 2/2011 Chou
 D634,773 S 3/2011 Fuchs
 D635,179 S 3/2011 Della Valle et al.
 D635,180 S 3/2011 Della Valle et al.
 D636,428 S 4/2011 Della Valle et al.
 D637,644 S 5/2011 Gonzalez
 D638,463 S 5/2011 Scott
 D639,845 S 6/2011 Fuchs
 D640,308 S 6/2011 Yang
 D640,311 S * 6/2011 Lombardo et al. D16/320
 D640,312 S 6/2011 Lombardo et al.
 D645,074 S 9/2011 Markovitz et al.
 D645,075 S 9/2011 Markovitz et al.
 D645,076 S 9/2011 Markovitz et al.
 D646,317 S 10/2011 Serlenga
 D647,124 S 10/2011 Li
 D647,125 S 10/2011 Fuchs
 D647,950 S 11/2011 Markovitz et al.
 D649,579 S 11/2011 Thixton
 D650,825 S 12/2011 Yee et al.
 D650,826 S 12/2011 Markovitz et al.
 D652,442 S 1/2012 Yee et al.
 D653,699 S 2/2012 Shin
 D654,529 S 2/2012 Markovitz et al.
 D654,530 S 2/2012 Markovitz et al.
 D654,531 S 2/2012 Markovitz et al.
 D654,946 S 2/2012 Markovitz et al.
 D658,704 S 5/2012 Markovitz et al.
 D659,182 S 5/2012 Shin et al.
 D661,340 S 6/2012 Kim et al.
 D663,764 S 7/2012 Serlenga
 D664,589 S * 7/2012 Gonzalez D16/320
 D664,590 S 7/2012 Shin
 D667,044 S 9/2012 Markovitz et al.
 D669,925 S 10/2012 Faber et al.
 D671,163 S 11/2012 Markovitz et al.

D671,591 S 11/2012 Markovitz et al.
 D671,978 S 12/2012 Markovitz et al.
 D671,980 S 12/2012 Sallard
 D671,984 S 12/2012 Fuchs
 D673,205 S 12/2012 Earley
 D673,599 S 1/2013 Earley
 D674,432 S 1/2013 Earley
 D674,434 S 1/2013 Rohrbach
 D675,665 S 2/2013 Faber et al.
 D675,666 S 2/2013 Thixton et al.
 D675,670 S 2/2013 Fuchs
 D675,671 S 2/2013 Markovitz et al.
 D677,311 S 3/2013 Markovitz et al.
 D677,312 S 3/2013 Markovitz et al.
 D677,313 S 3/2013 Markovitz et al.
 D677,314 S 3/2013 Markovitz et al.
 D677,316 S 3/2013 Markovitz et al.
 D680,577 S 4/2013 Markovitz et al.
 D681,094 S 4/2013 Markovitz et al.
 D681,095 S 4/2013 Markovitz et al.
 D681,099 S 4/2013 Markovitz et al.
 D681,100 S 4/2013 Markovitz et al.
 D683,389 S 5/2013 Stables
 D685,409 S 7/2013 Sheldon
 D688,728 S 8/2013 Markovitz et al.
 2006/0238698 A1 10/2006 Sheldon
 2006/0238700 A1 10/2006 Del Vecchio
 2006/0268218 A1 11/2006 Medana
 2007/0261155 A1 11/2007 Tabacchi
 2010/0085533 A1 4/2010 Calilung et al.

OTHER PUBLICATIONS

Jose, Blue Mirror Lens. Costa Del Mar. Downloaded Apr. 20, 2012 at <http://www.costadelmar.com/shop/sunglasses/jose>.
 Cheeca, Copper Lens. Costa Del Mar. Downloaded Apr. 20, 2012 at <http://www.costadelmar.com/shop/sunglasses/cheeca>.
 Bonita, Gray Lens. Costa Del Mar. Downloaded Apr. 20, 2012 at <http://www.costadelmar.com/shop/sunglasses/bonita>.

* cited by examiner

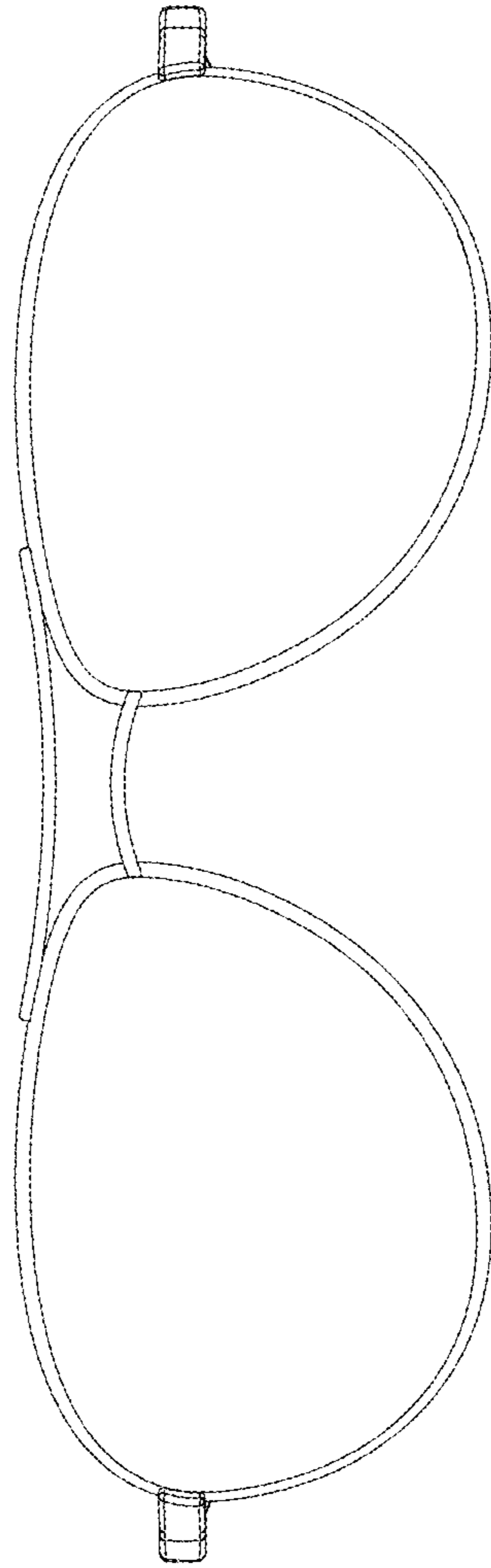

figure 1

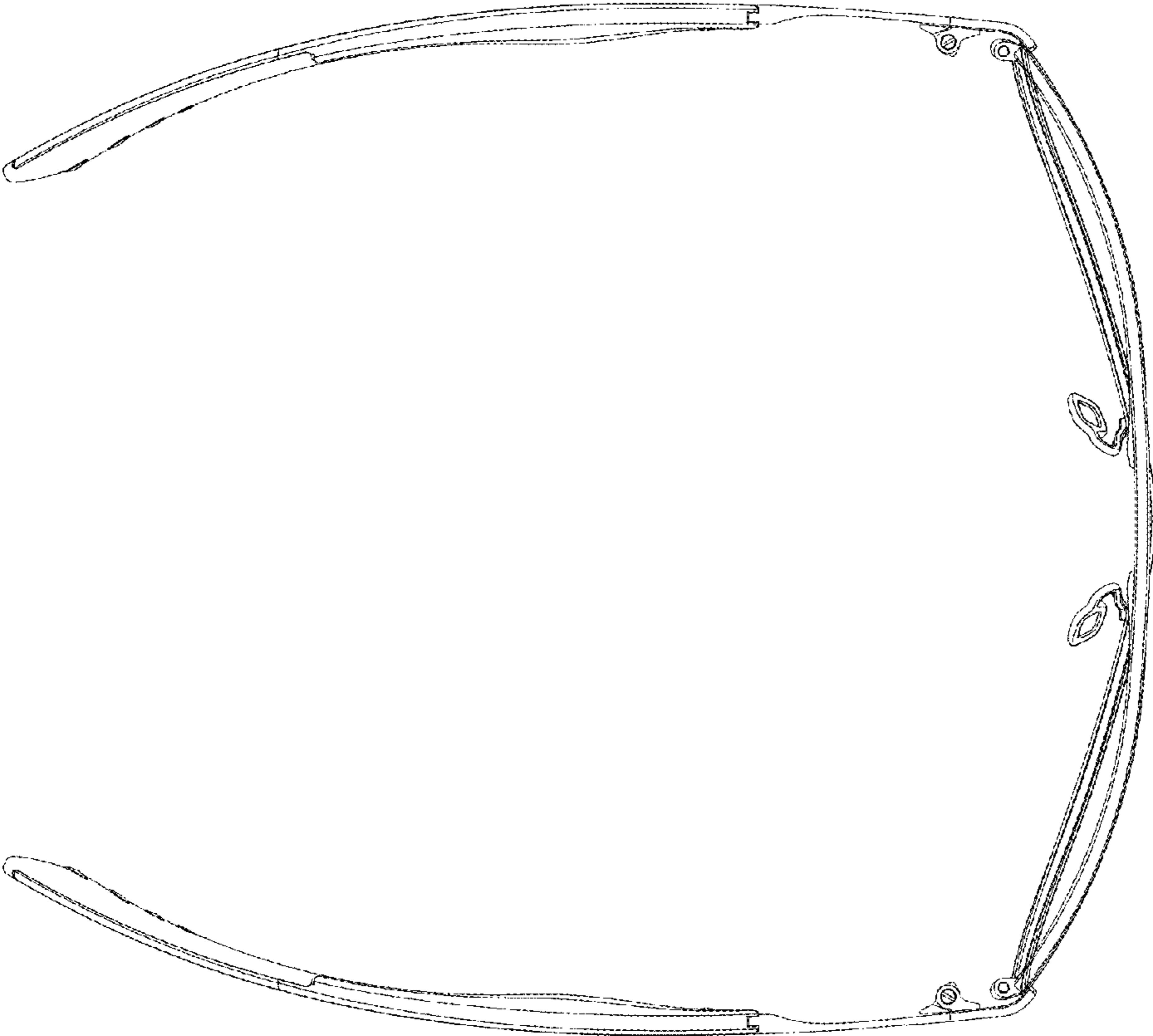

figure 2

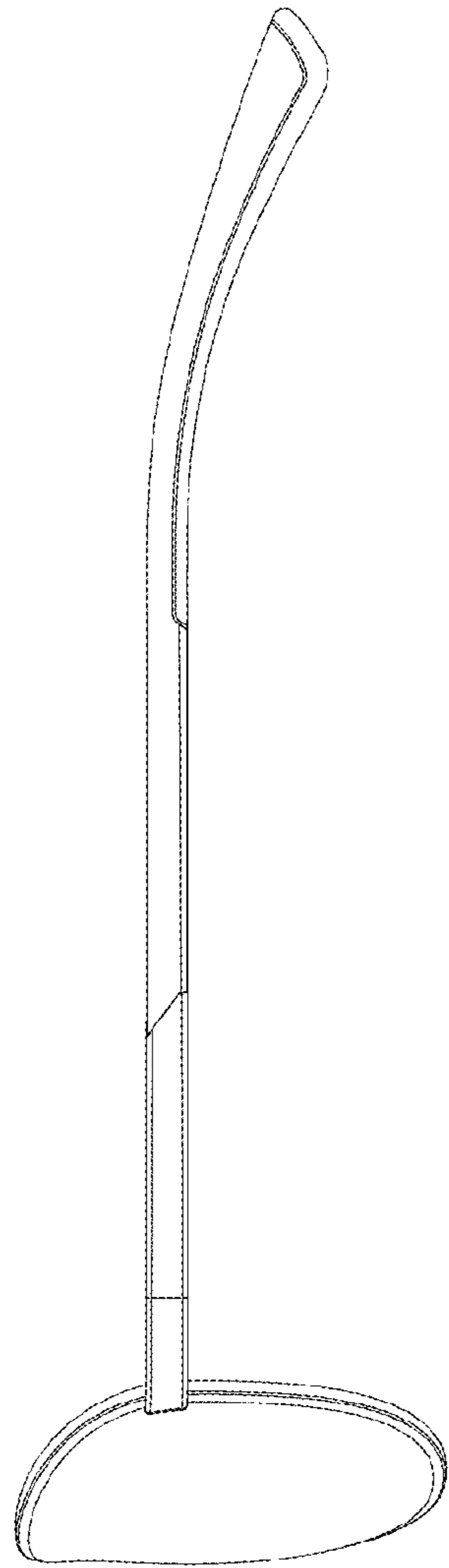

figure 3

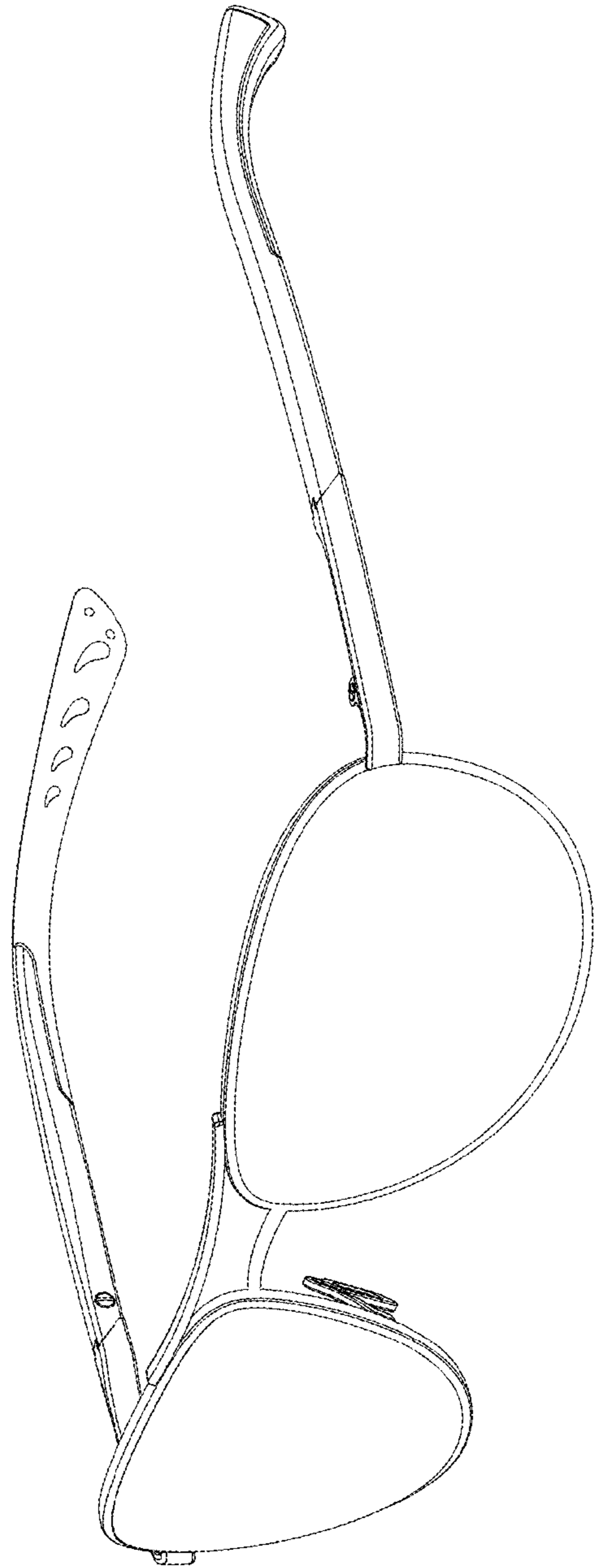

figure 4

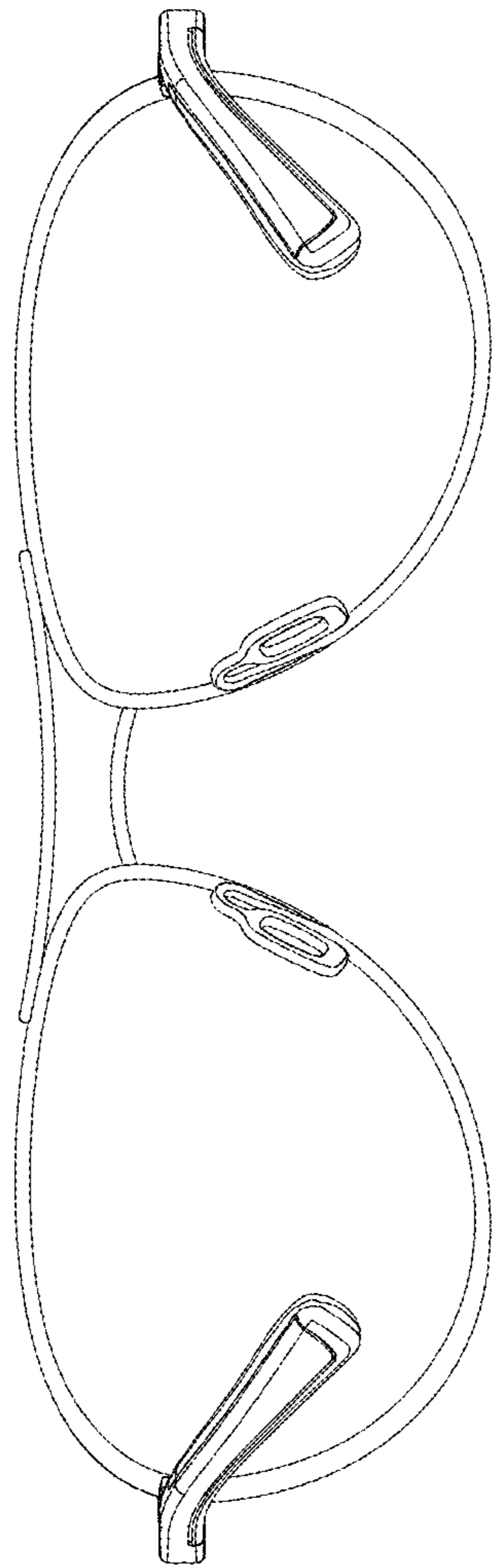

figure 5

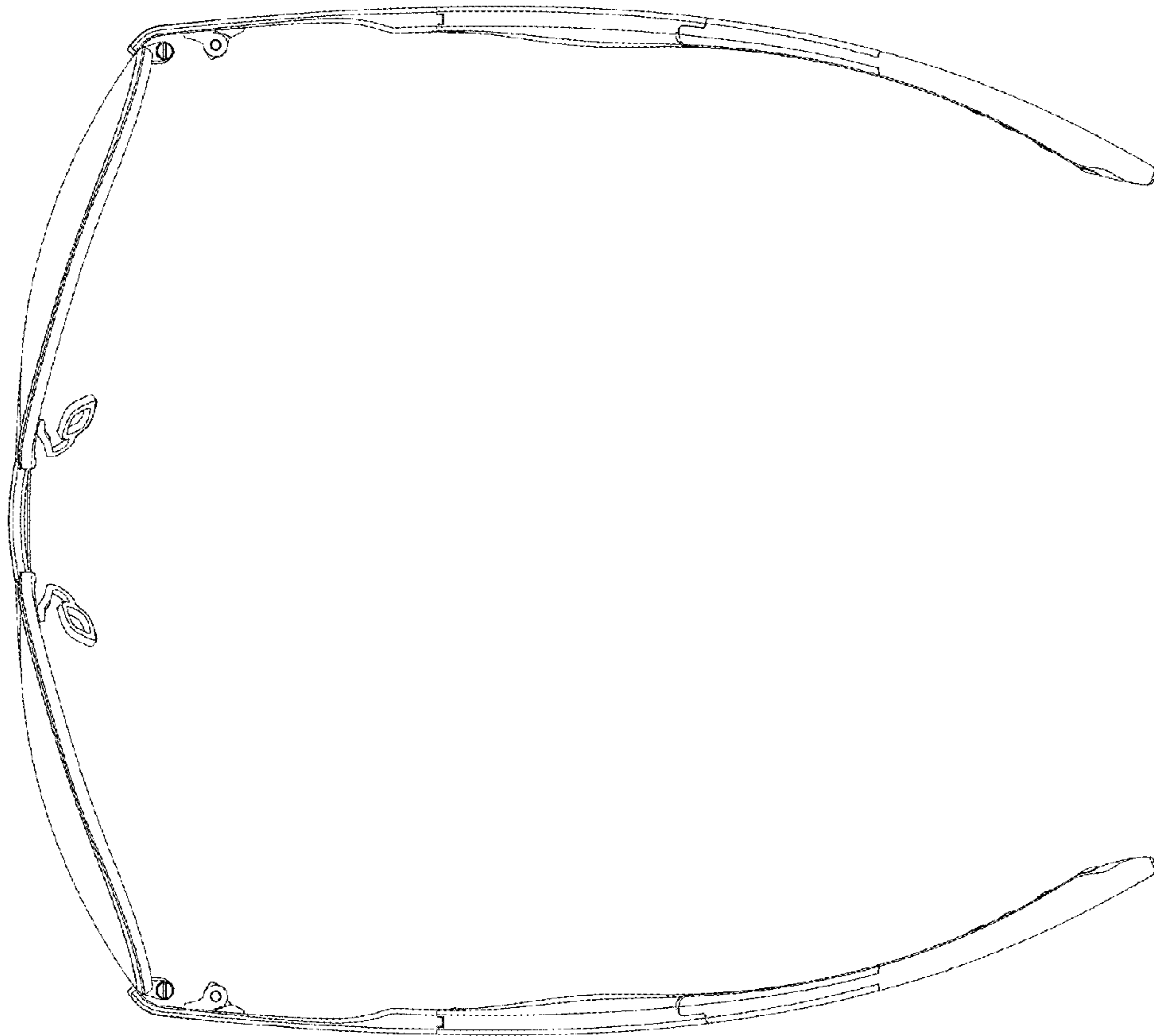

figure 6