



US00D704757S

(12) **United States Design Patent**  
**Nagai et al.**

(10) **Patent No.:** **US D704,757 S**

(45) **Date of Patent:** **\*\* May 13, 2014**

(54) **EXTRA FLEXIBLE WELD WIRE CONDUIT FOR INDUSTRIAL ROBOT**

(71) Applicant: **Panasonic Corporation**, Kadoma (JP)

(72) Inventors: **Takashi Nagai**, Hyogo (JP); **Wataru Takahashi**, Osaka (JP); **Kiyohito Maruo**, Osaka (JP); **Kazuya Kitayama**, Hyogo (JP); **Takayasu Ohara**, Hyogo (JP); **Eiji Honda**, Osaka (JP)

(73) Assignee: **Panasonic Corporation**, Osaka (JP)

(\*\*) Term: **14 Years**

(21) Appl. No.: **29/462,031**

(22) Filed: **Jul. 30, 2013**

(30) **Foreign Application Priority Data**

Feb. 27, 2013 (JP) ..... 2013-004016

(51) **LOC (10) Cl.** ..... **15-99**

(52) **U.S. Cl.**  
USPC ..... **D15/199**; D15/144

(58) **Field of Classification Search**  
USPC ..... D15/122, 144, 144.1, 14.2, 199;  
74/490.01, 490.02, 490.03, 490.05;  
198/367, 370.1, 370.04, 722, 771, 782,  
198/866, 890, 890.1; 219/124.34, 639;  
318/560; 414/744.1, 935, 936, 937,  
414/938, 940; 700/150  
See application file for complete search history.

(56) **References Cited**

**U.S. PATENT DOCUMENTS**

D196,048 S \* 8/1963 Kolterman ..... D15/144  
D260,597 S \* 9/1981 Mathuda ..... D8/14.1

D274,182 S \* 6/1984 Kato ..... D15/199  
4,518,307 A \* 5/1985 Bloch ..... 414/729  
D287,135 S \* 12/1986 Nagatani et al. .... D15/144  
D290,263 S \* 6/1987 Shibayama et al. .... D15/199  
D293,116 S \* 12/1987 Stackhouse et al. .... D15/199  
D293,324 S \* 12/1987 Gotou et al. .... D15/199  
D294,589 S \* 3/1988 Kajiya ..... D15/144  
D343,630 S \* 1/1994 Tomiyama et al. .... D15/199  
D455,163 S \* 4/2002 Kawaguchi ..... D15/199  
D523,303 S \* 6/2006 Amin ..... D8/14.1  
D600,261 S \* 9/2009 Raineri ..... D15/150  
D625,347 S \* 10/2010 Feng ..... D15/199  
D643,053 S \* 8/2011 Langlois et al. .... D15/144  
D678,376 S \* 3/2013 Coleman ..... D15/150

**FOREIGN PATENT DOCUMENTS**

JP D1119460 S 8/2001  
JP D1386583 S 5/2010

\* cited by examiner

*Primary Examiner* — Patricia Palasik

(74) *Attorney, Agent, or Firm* — Brinks Gilson & Lione

(57) **CLAIM**

We claim the ornamental design for an extra flexible weld wire conduit for industrial robot, as shown and described.

**DESCRIPTION**

FIG. 1 is a perspective view of an extra flexible weld wire conduit for industrial robot of the present invention;  
FIG. 2 is a front view thereof;  
FIG. 3 is a rear view thereof;  
FIG. 4 is a left side view thereof;  
FIG. 5 is a right side view thereof;  
FIG. 6 is a top view thereof; and,  
FIG. 7 is a bottom view thereof.  
The broken lines shown represent unclaimed subject matter and form no part of the claimed design.

**1 Claim, 7 Drawing Sheets**

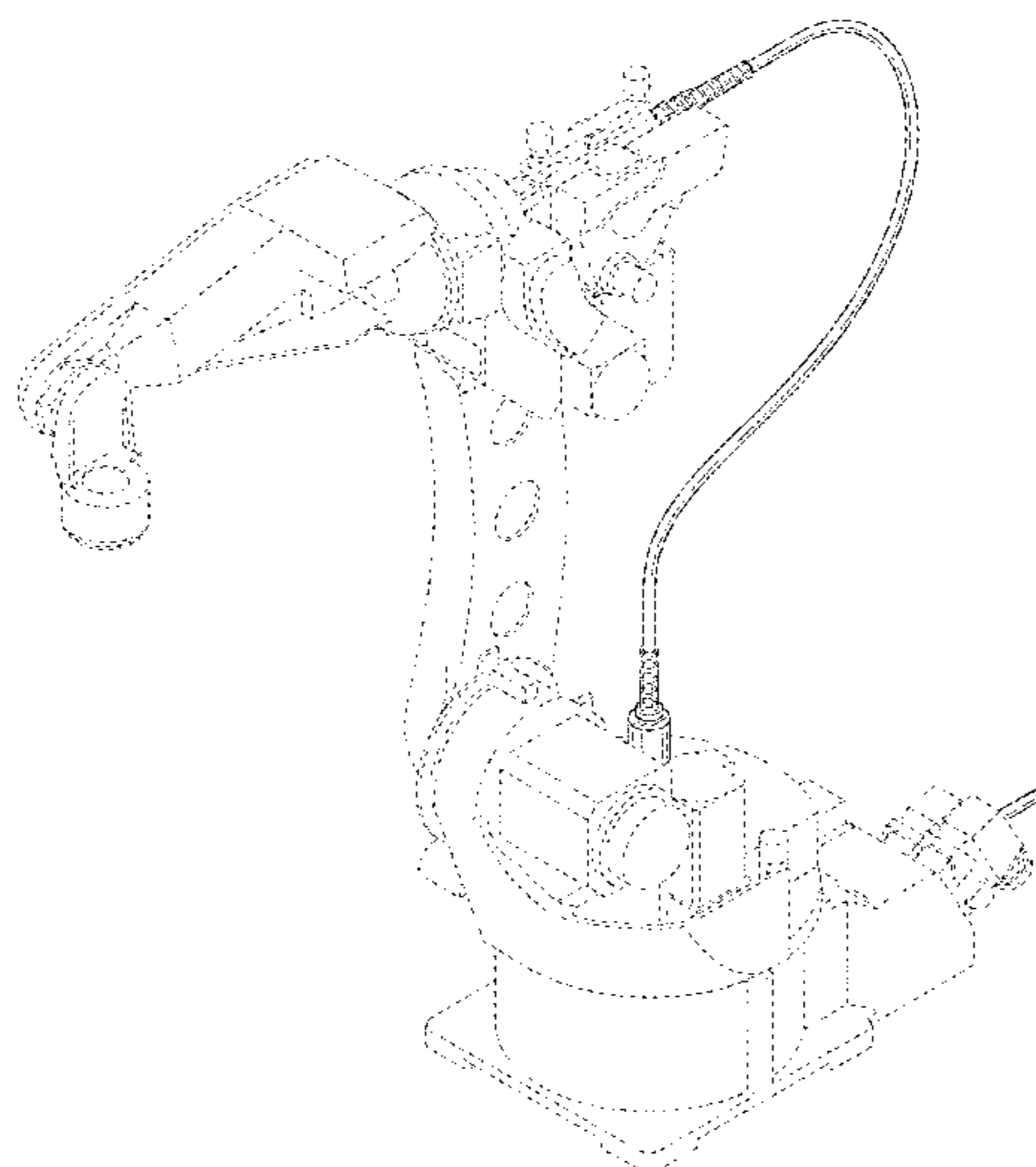

FIG. 1

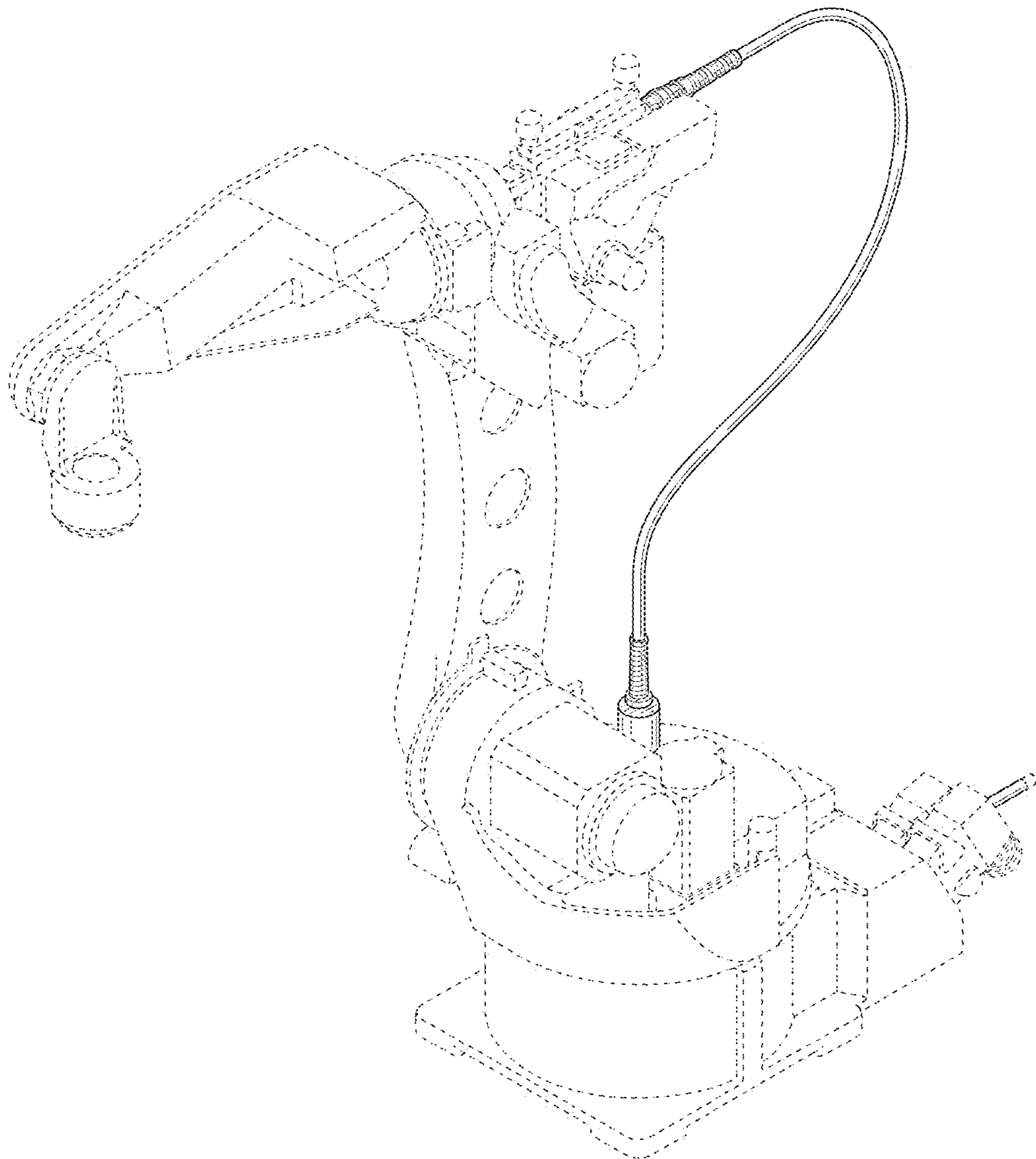

FIG. 2

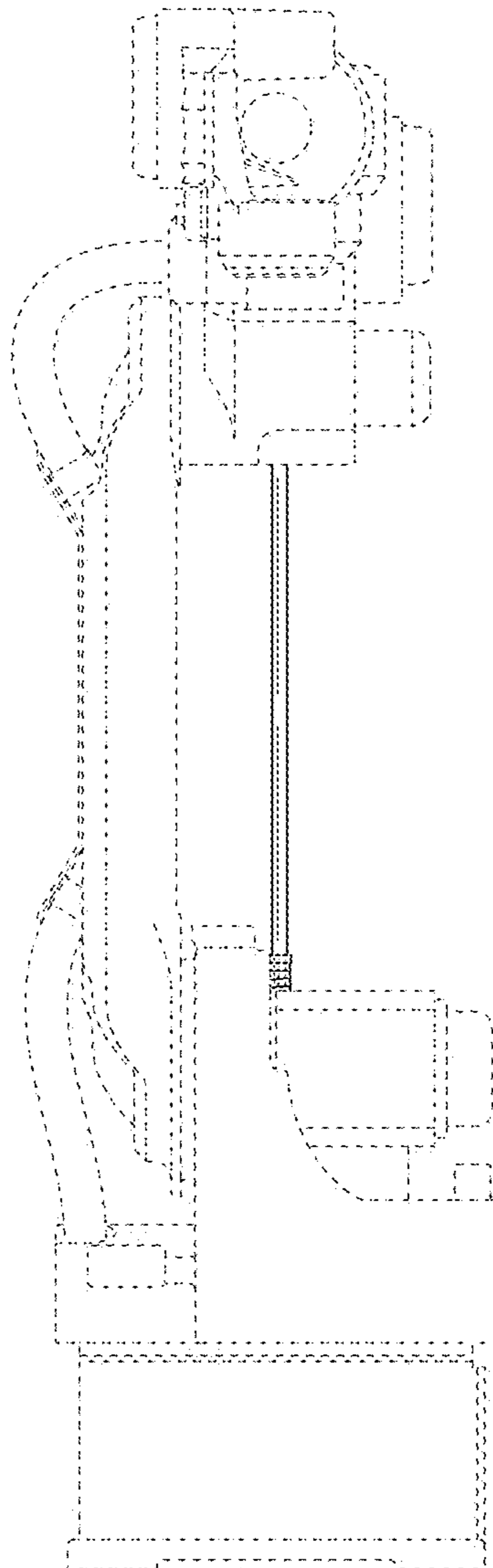

FIG. 3

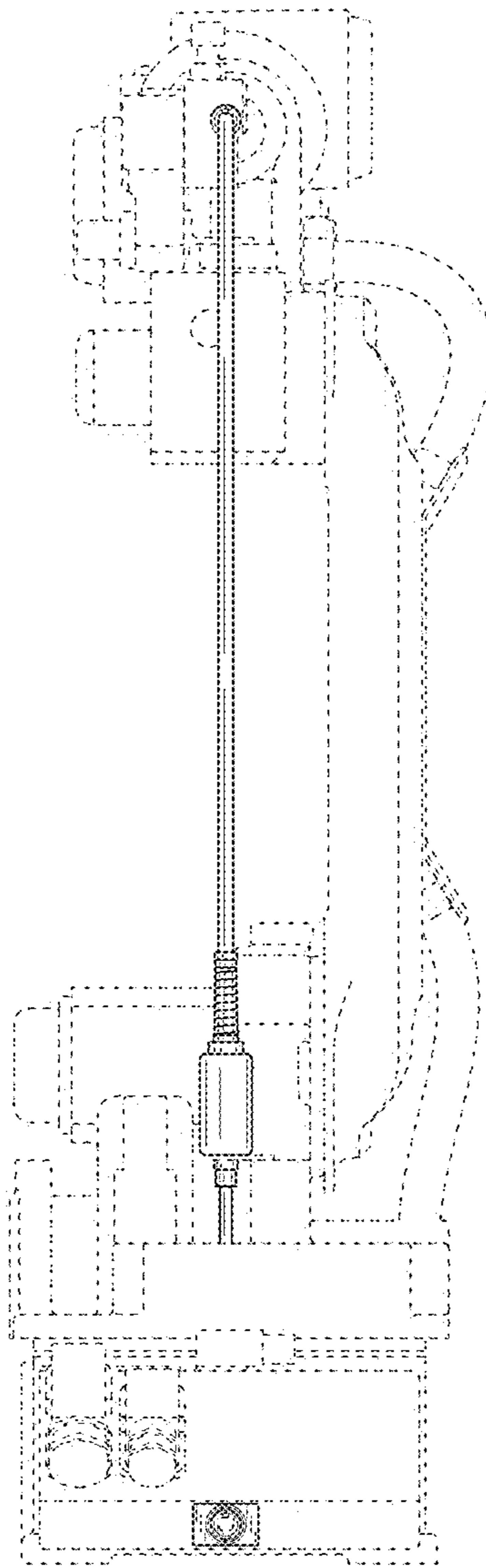

FIG. 4

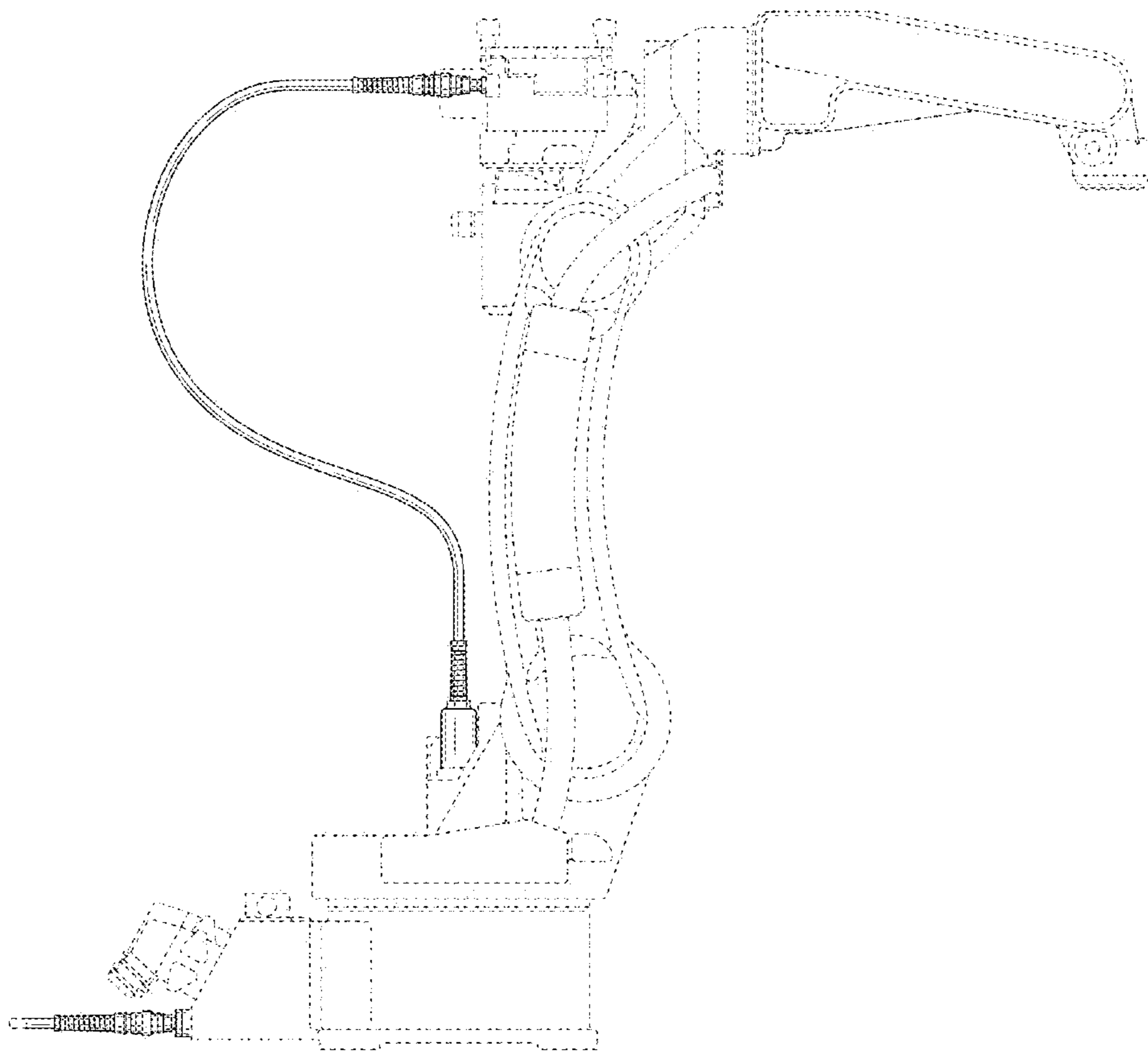

FIG. 5

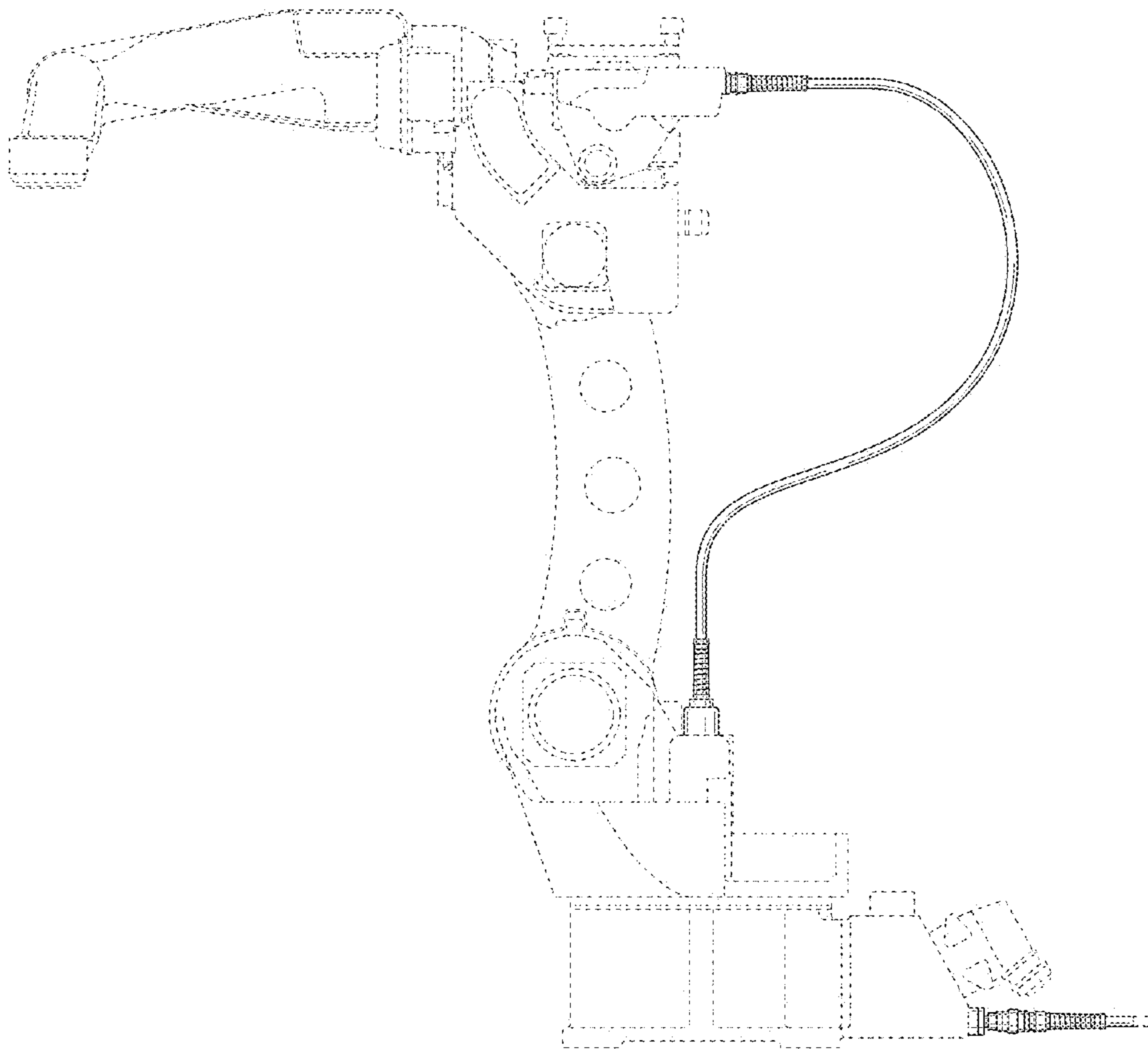



FIG. 6

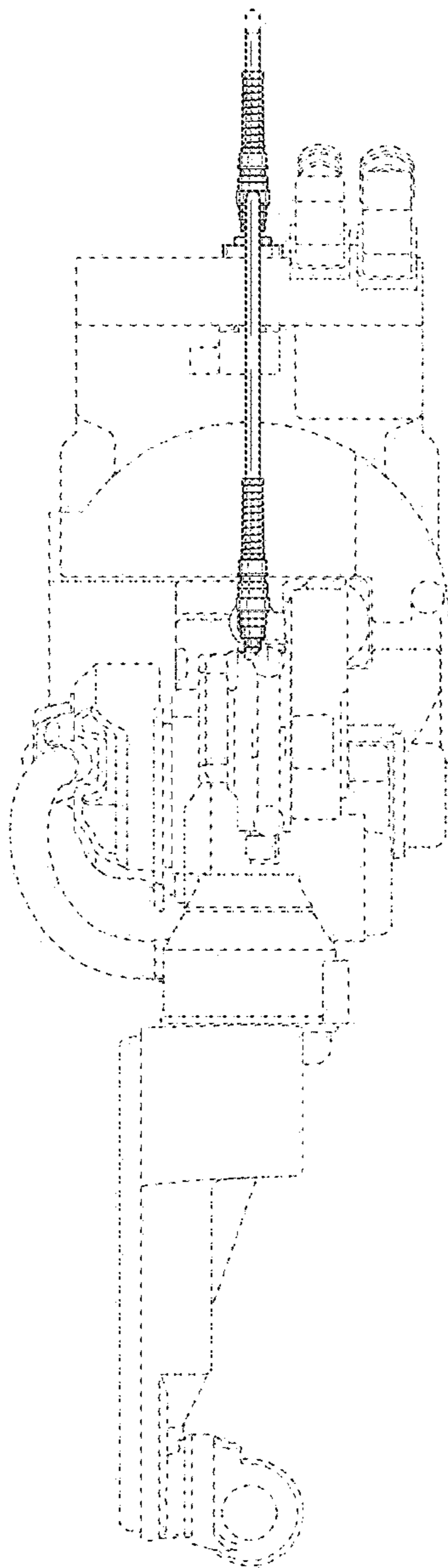

FIG. 7

