



US00D704729S

(12) **United States Design Patent**
Khanna

(10) **Patent No.:** **US D704,729 S**

(45) **Date of Patent:** **** May 13, 2014**

(54) **DEVICE DISPLAY SCREEN WITH AN ANIMATED GRAPHICAL USER INTERFACE HAVING PARALLEL ICONS**

(75) Inventor: **Ramaneek Khanna**, Saratoga, CA (US)

(73) Assignee: **eBay Inc.**, San Jose, CA (US)

(**) Term: **14 Years**

(21) Appl. No.: **29/397,153**

(22) Filed: **Jul. 12, 2011**

(51) **LOC (10) Cl.** **14-04**

(52) **U.S. Cl.**
USPC **D14/488**

(58) **Field of Classification Search**
USPC D14/485–495, 341, 327; 715/772, 856,
715/839, 809, 771, 719, 764, 227, 804;
707/792, 769, 706; 705/310
See application file for complete search history.

(56) **References Cited**

U.S. PATENT DOCUMENTS

5,880,733	A *	3/1999	Horvitz et al.	715/850
6,734,859	B2 *	5/2004	Hayashi et al.	345/475
7,051,291	B2 *	5/2006	Sciammarella et al.	715/838
7,065,710	B2 *	6/2006	Hayashi et al.	715/732
D555,663	S *	11/2007	Nagata et al.	D14/488
D559,855	S *	1/2008	Sato et al.	D14/486
D591,765	S *	5/2009	Amacker	D14/488
D593,116	S *	5/2009	Garcia et al.	D14/487
D599,806	S *	9/2009	Brown et al.	D14/485
D599,811	S *	9/2009	Watanabe et al.	D14/486
D600,249	S *	9/2009	Nagata et al.	D14/486
D604,742	S *	11/2009	Nagata et al.	D14/486
D607,005	S *	12/2009	Ording et al.	D14/488
7,636,889	B2 *	12/2009	Weber et al.	715/723
D609,715	S *	2/2010	Chaudhri	D14/486
7,681,149	B2 *	3/2010	Lahdesmaki	715/841
D614,640	S *	4/2010	Viegers et al.	D14/486
D615,989	S *	5/2010	Chaudhri	D14/488
D624,932	S *	10/2010	Chaudhri	D14/488
D625,323	S *	10/2010	Matsushima et al.	D14/487
D628,581	S *	12/2010	Kurozumi et al.	D14/488
D633,920	S *	3/2011	Luke et al.	D14/488
D634,753	S *	3/2011	Loretan et al.	D14/488

D637,606	S *	5/2011	Luke et al.	D14/488
D638,432	S *	5/2011	Flik et al.	D14/486
D638,853	S *	5/2011	Brinda	D14/488
D643,438	S *	8/2011	Gardner et al.	D14/486
D643,850	S *	8/2011	Arnold et al.	D14/487
D643,851	S *	8/2011	Arnold et al.	D14/487
D651,608	S *	1/2012	Allen et al.	D14/485
D658,199	S *	4/2012	Lee et al.	D14/486
D663,315	S *	7/2012	Cielak et al.	D14/488
D664,560	S *	7/2012	Gilmore et al.	D14/488
D664,968	S *	8/2012	Lee et al.	D14/485
D664,975	S *	8/2012	Arnold	D14/487
8,296,656	B2 *	10/2012	Dowdy et al.	715/727
D681,051	S *	4/2013	Asai et al.	D14/487
D682,875	S *	5/2013	Frijlink et al.	D14/488
D686,237	S *	7/2013	Alucema et al.	D14/486
2003/0080977	A1 *	5/2003	Scott et al.	345/629
2005/0210410	A1 *	9/2005	Ohwa et al.	715/821
2006/0109283	A1 *	5/2006	Shipman et al.	345/629
2006/0236251	A1 *	10/2006	Kataoka et al.	715/757
2007/0260994	A1 *	11/2007	Sciammarella et al.	715/769
2008/0307309	A1 *	12/2008	Marinkovich et al.	715/723
2009/0158203	A1 *	6/2009	Kerr et al.	715/784
2010/0095240	A1 *	4/2010	Shiplacoff et al.	715/784
2010/0122207	A1 *	5/2010	Kim et al.	715/788
2010/0125786	A1 *	5/2010	Ozawa et al.	715/702

* cited by examiner

Primary Examiner — Kevin Rudzinski

(74) *Attorney, Agent, or Firm* — Haynes and Boone, LLP

(57) **CLAIM**

The ornamental design for a device display screen with an animated graphical user interface having parallel icons, as shown and described.

DESCRIPTION

FIG. 1 is a perspective view of a device display screen with an animated graphical user interface having parallel icons showing our new invention;
FIG. 2 is a first front elevation view of a sequence thereof; showing a first embodiment;
FIG. 3 is a second image thereof;
FIG. 4 is a third image thereof;
FIG. 5 is a fourth image thereof;
FIG. 6 is a first front elevation view of a sequence thereof; showing a second embodiment;

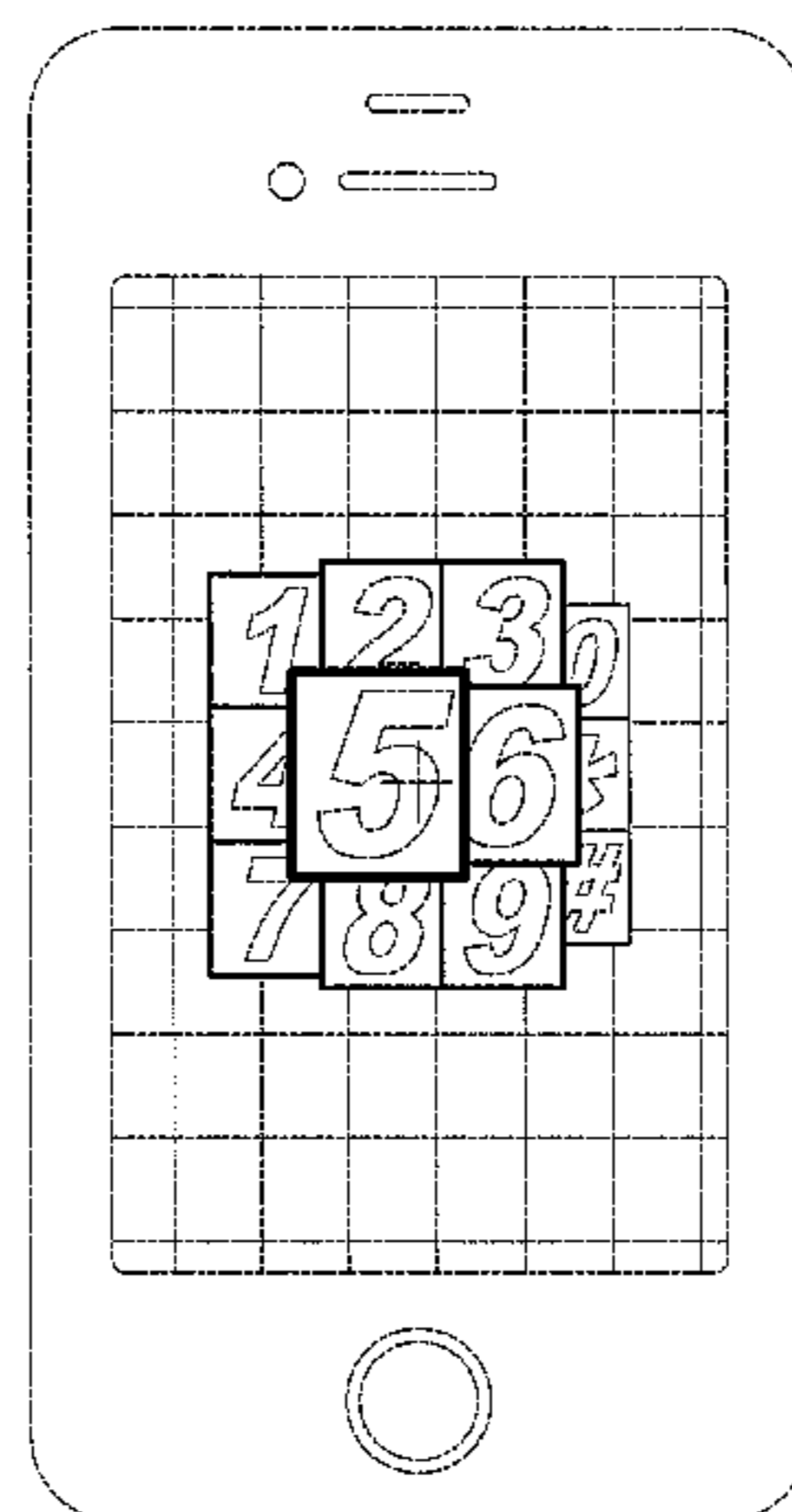
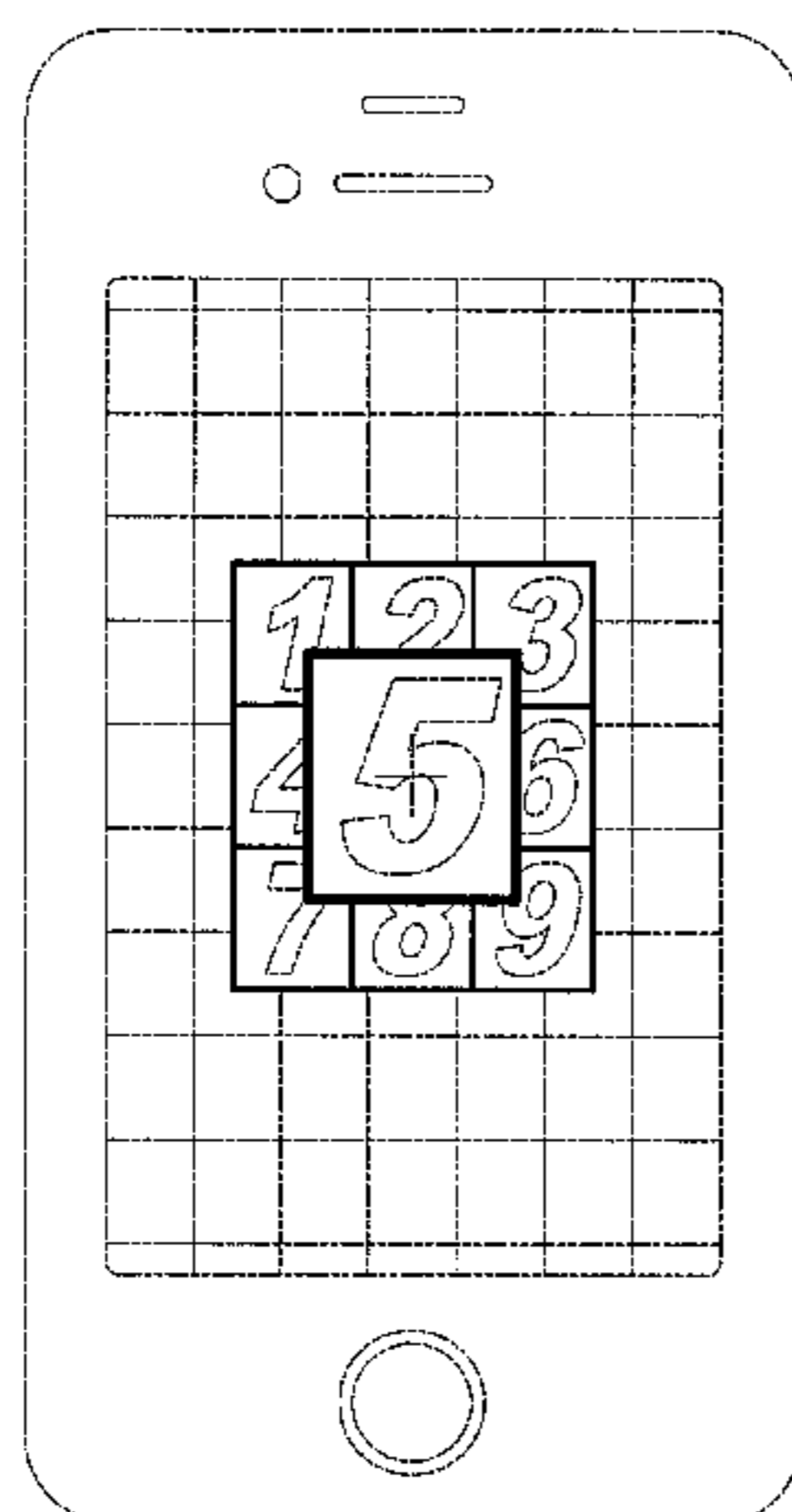

FIG. 7 is a second image thereof;
FIG. 8 is a third image thereof;
FIG. 9 is a fourth image thereof;
FIG. 10 is a first front elevation view of a sequence thereof;
showing a third embodiment;
FIG. 11 is a second image thereof;
FIG. 12 is a third image thereof;
FIG. 13 is a fourth image thereof;
FIG. 14 is a first front elevation view of a sequence thereof;
showing a fourth embodiment;
FIG. 15 is a second image thereof;
FIG. 16 is a third image thereof;
FIG. 17 is a fourth image thereof;
FIG. 18 is a first front elevation view of a sequence thereof;
showing a fifth embodiment;
FIG. 19 is a second image thereof;
FIG. 20 is a third image thereof;
FIG. 21 is a fourth image thereof;
FIG. 22 is a first front elevation view of a sequence thereof;
showing a sixth embodiment;
FIG. 23 is a second image thereof;
FIG. 24 is a third image thereof;
FIG. 25 is a fourth image thereof;

FIG. 26 is a first front elevation view of a sequence thereof;
showing a seventh embodiment;
FIG. 27 is a second image thereof;
FIG. 28 is a third image thereof;
FIG. 29 is a fourth image thereof
FIG. 30 is a first front elevation view of a sequence thereof;
showing an eighth embodiment;
FIG. 31 is a second image thereof;
FIG. 32 is a third image thereof; and,
FIG. 33 is a fourth image thereof.

The broken lines showing the device, device display screen, background computer-generated icons, or other features form no part of the claimed design. The inventive design includes the design pattern formed from the combination of the computer-generated icons.

The process or period in which an image series transitions or scrolls from one image to another image forms no part of the claimed invention.

The design pattern shown includes quadrangle-shaped computer-generated icons arranged into a design pattern, the design pattern of which is the inventive design, where the quadrangle-shaped computer-generated icons in the design pattern may be modified in quadrangle aspect ratio.

1 Claim, 33 Drawing Sheets

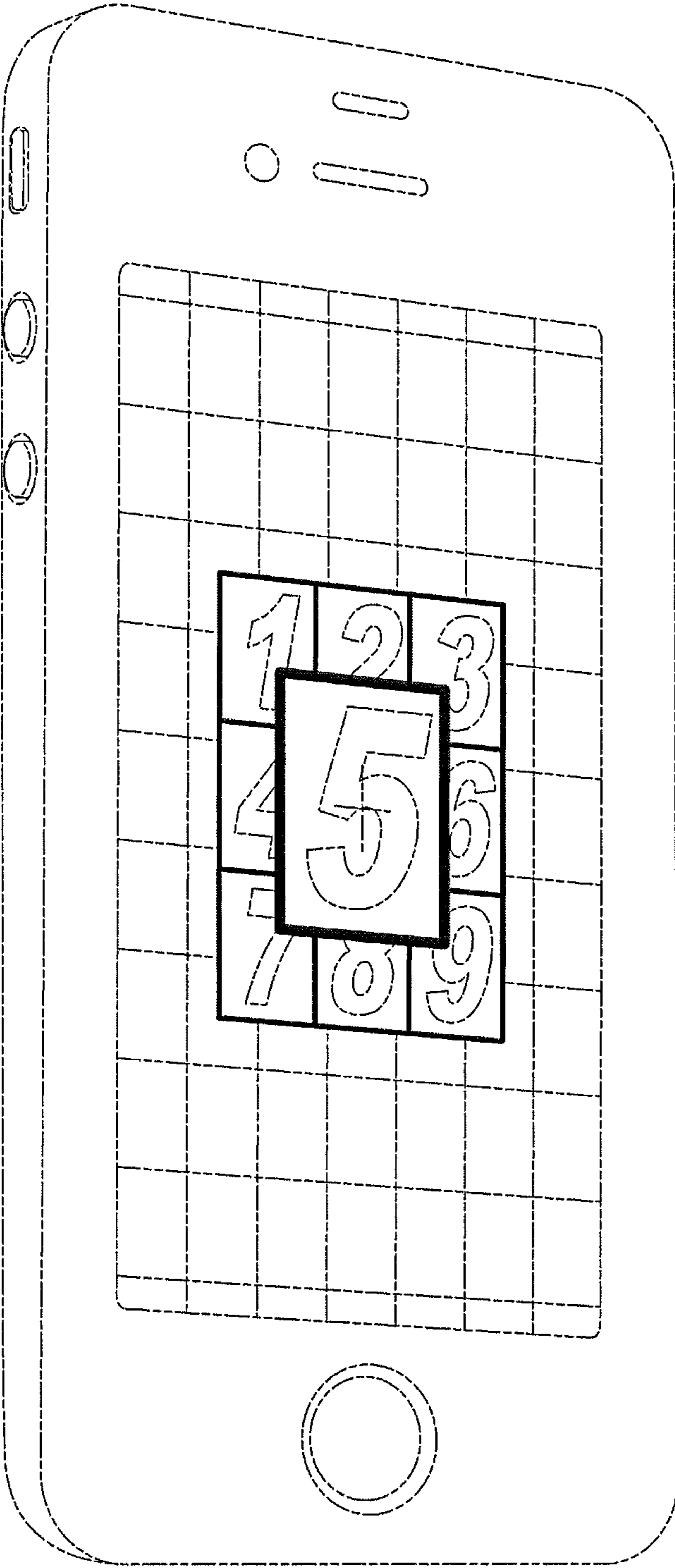

FIG. 1

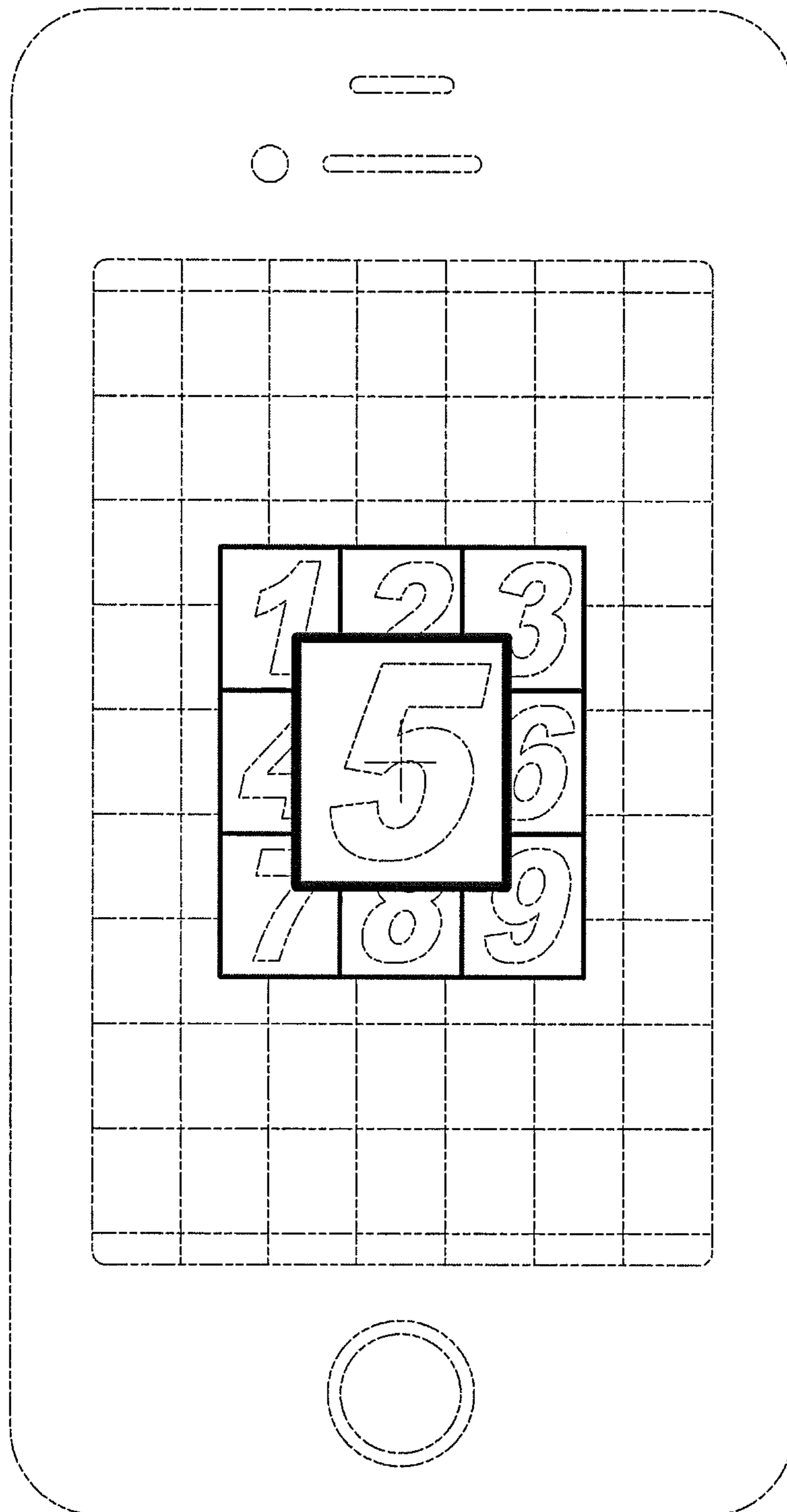

FIG. 2

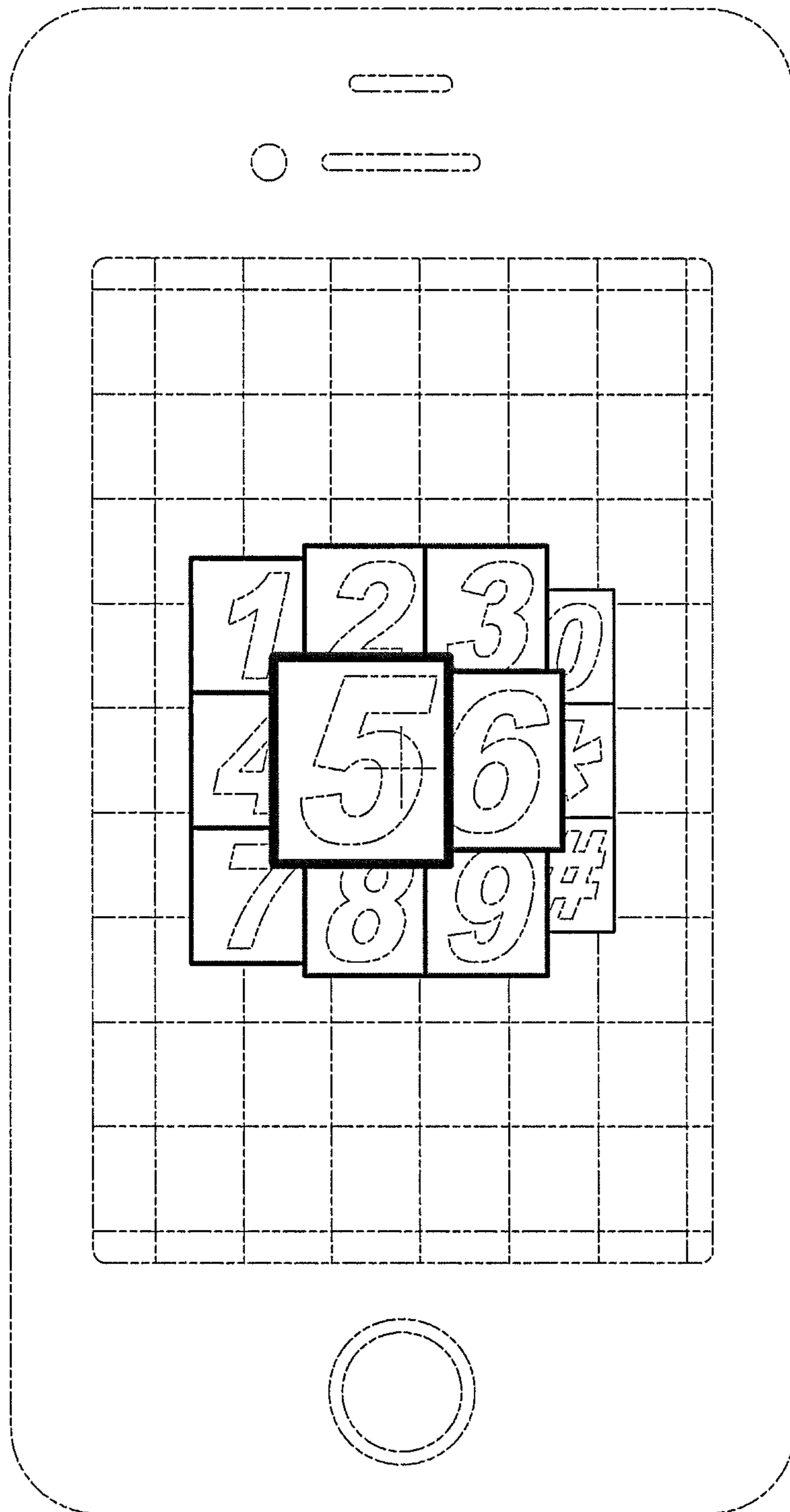

FIG. 3

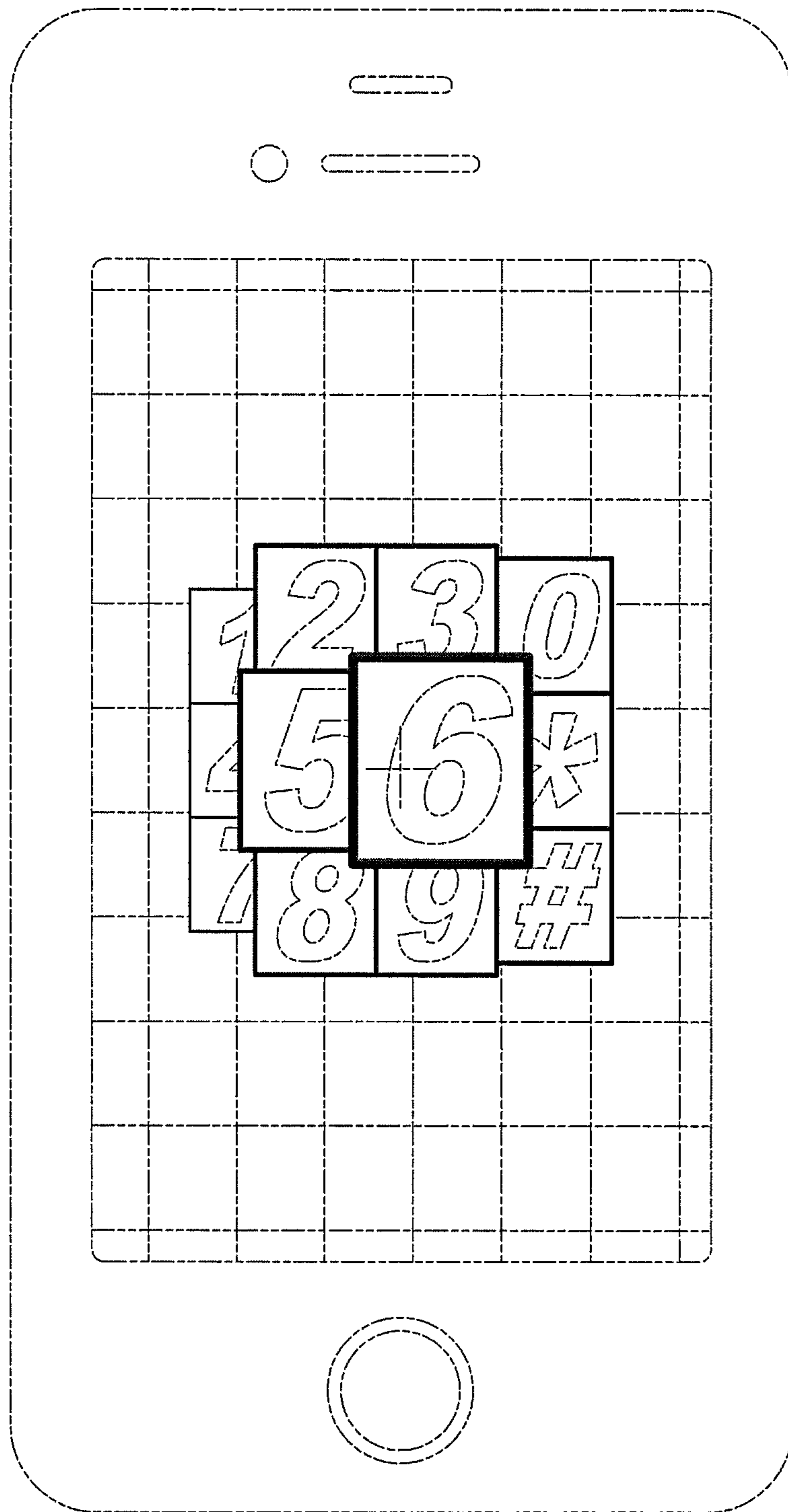

FIG. 4

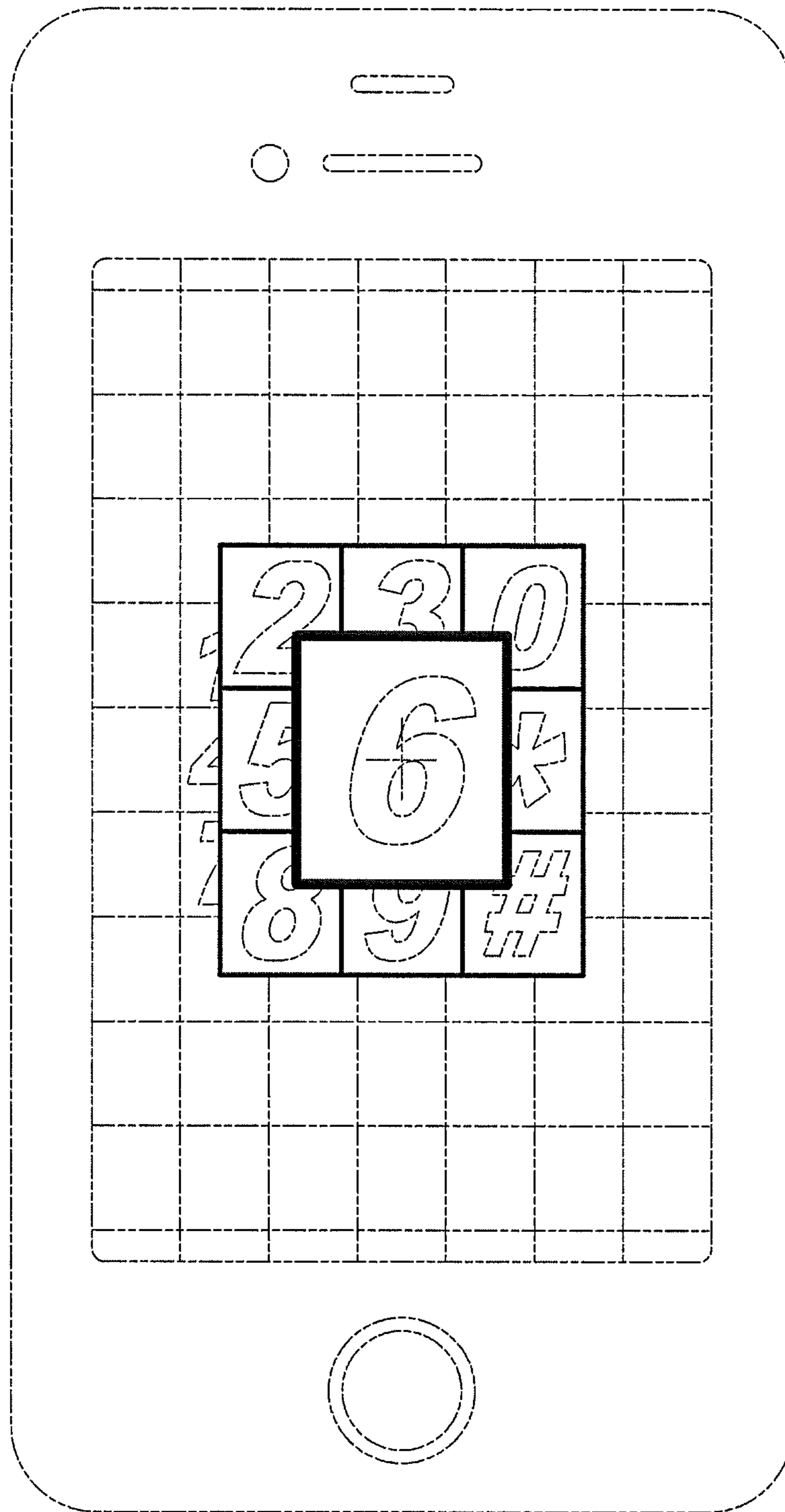

FIG. 5

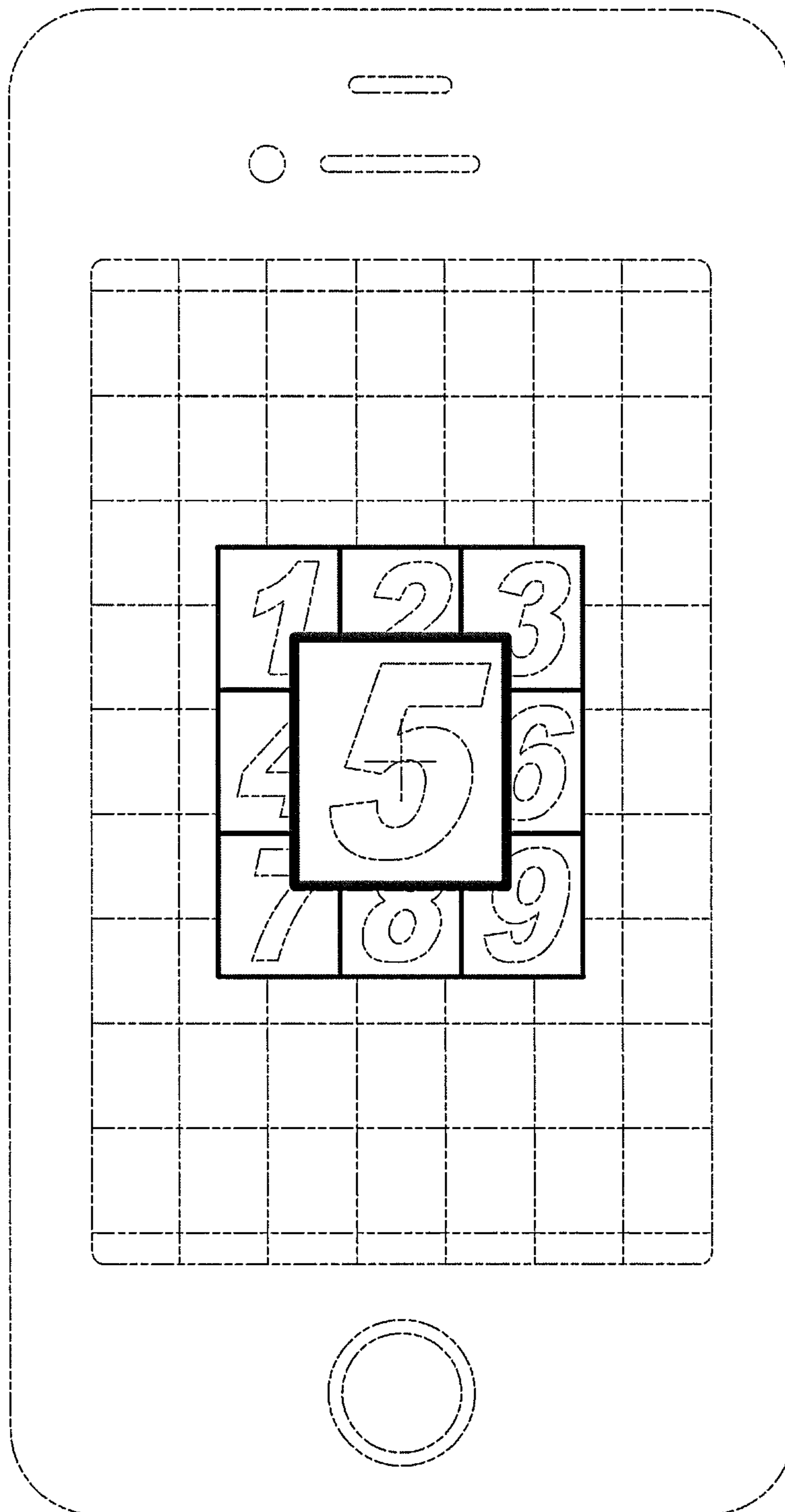

FIG. 6

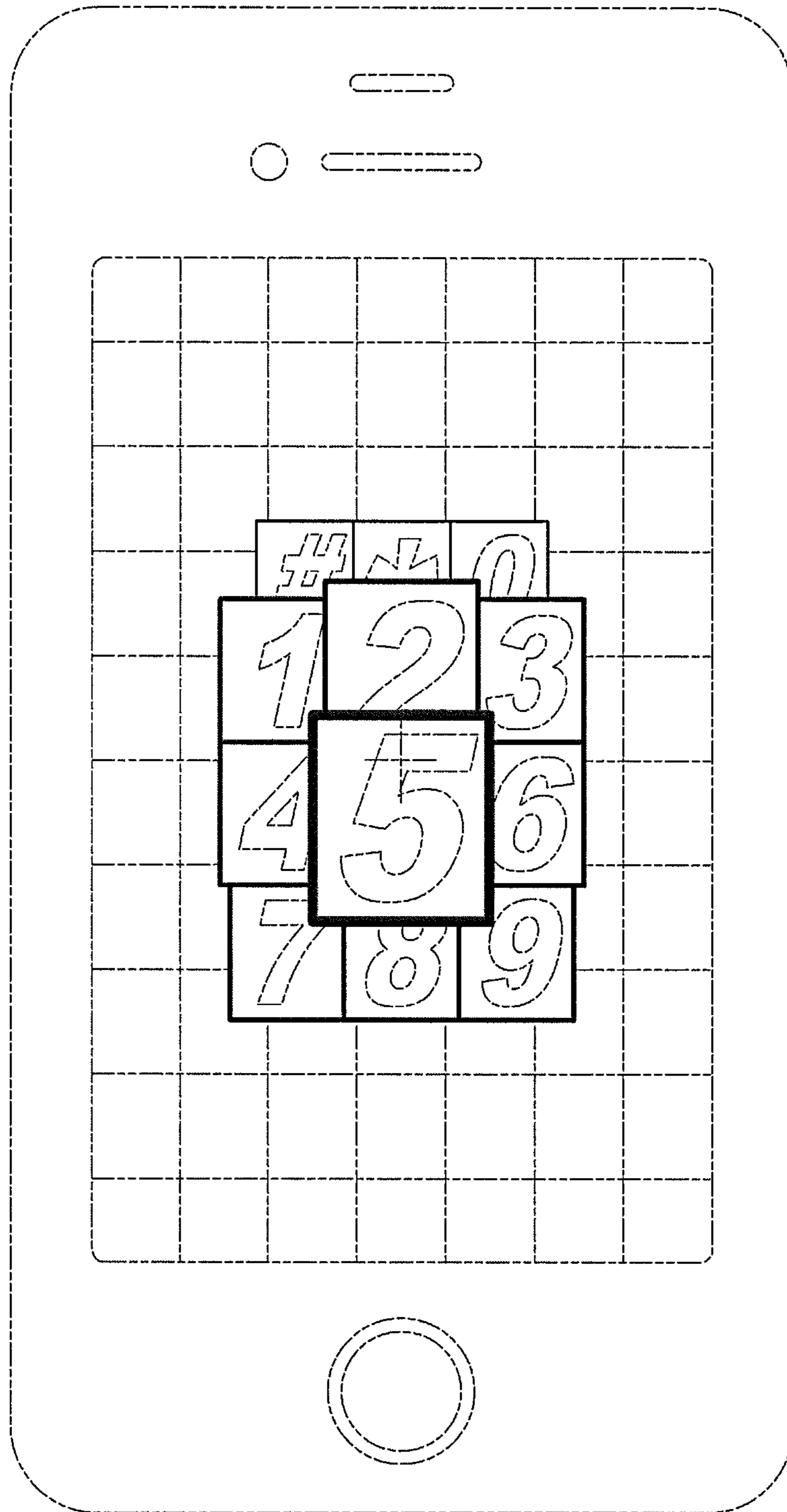

FIG. 7

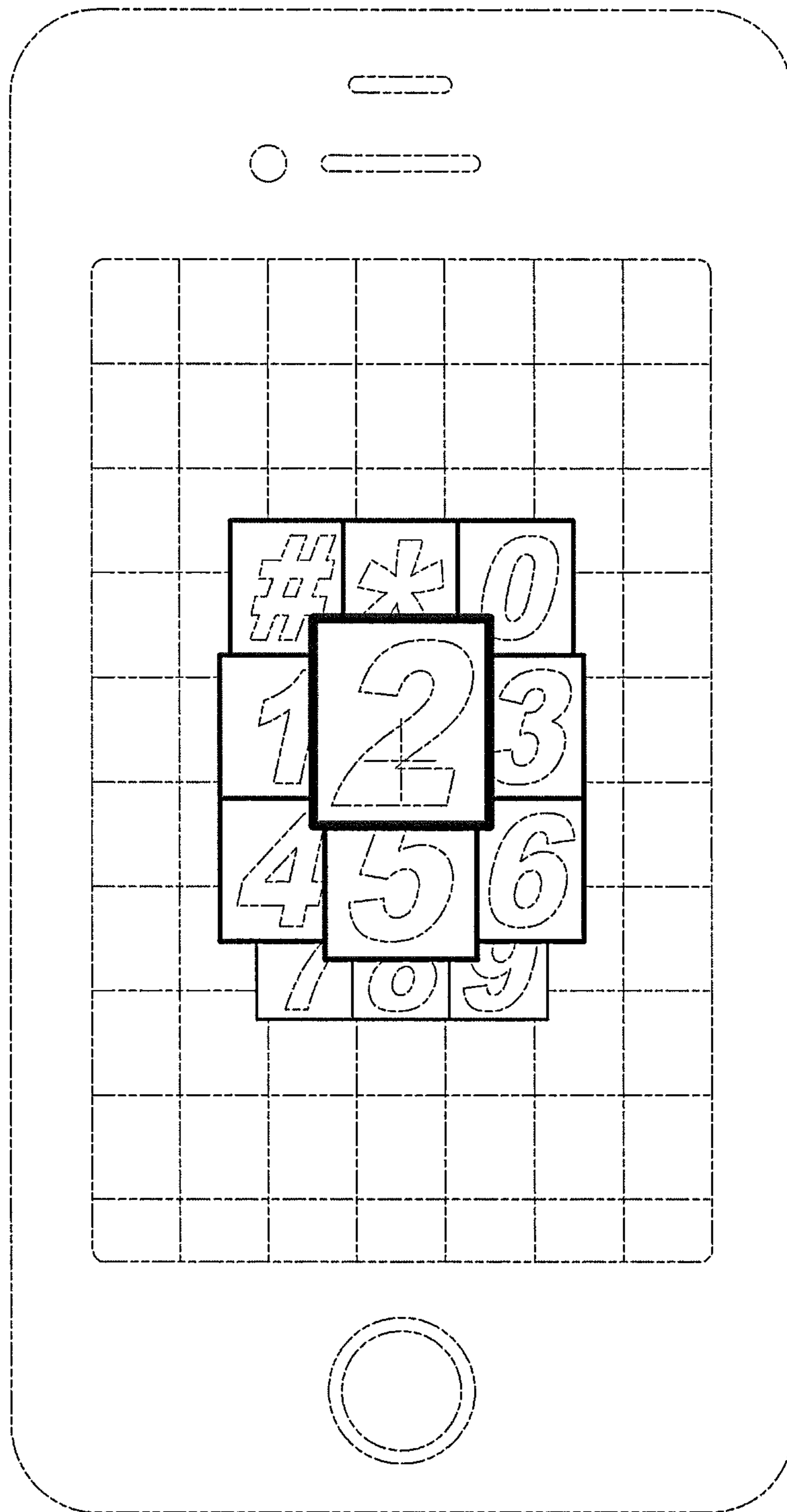

FIG. 8

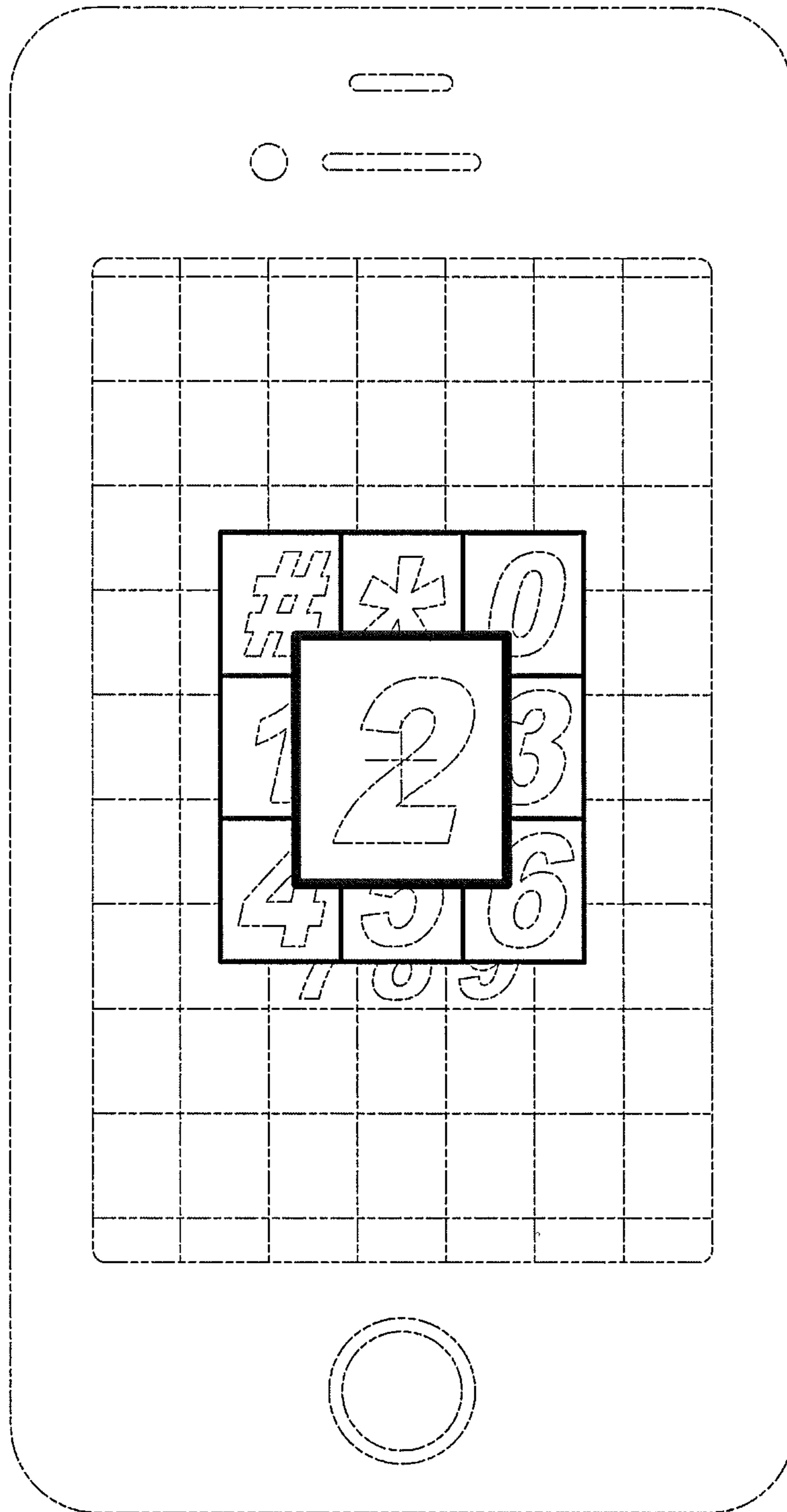

FIG. 9

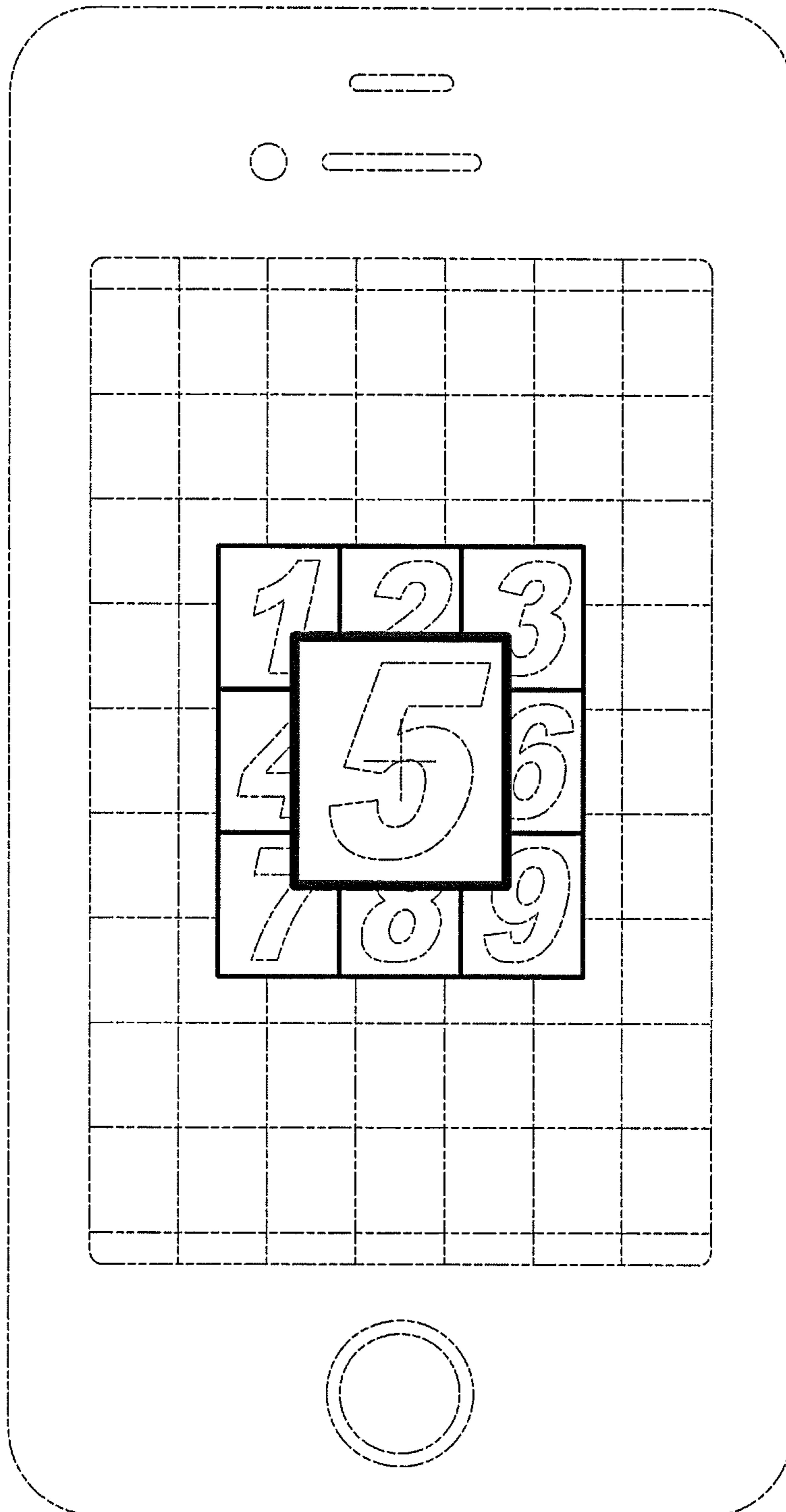

FIG. 10

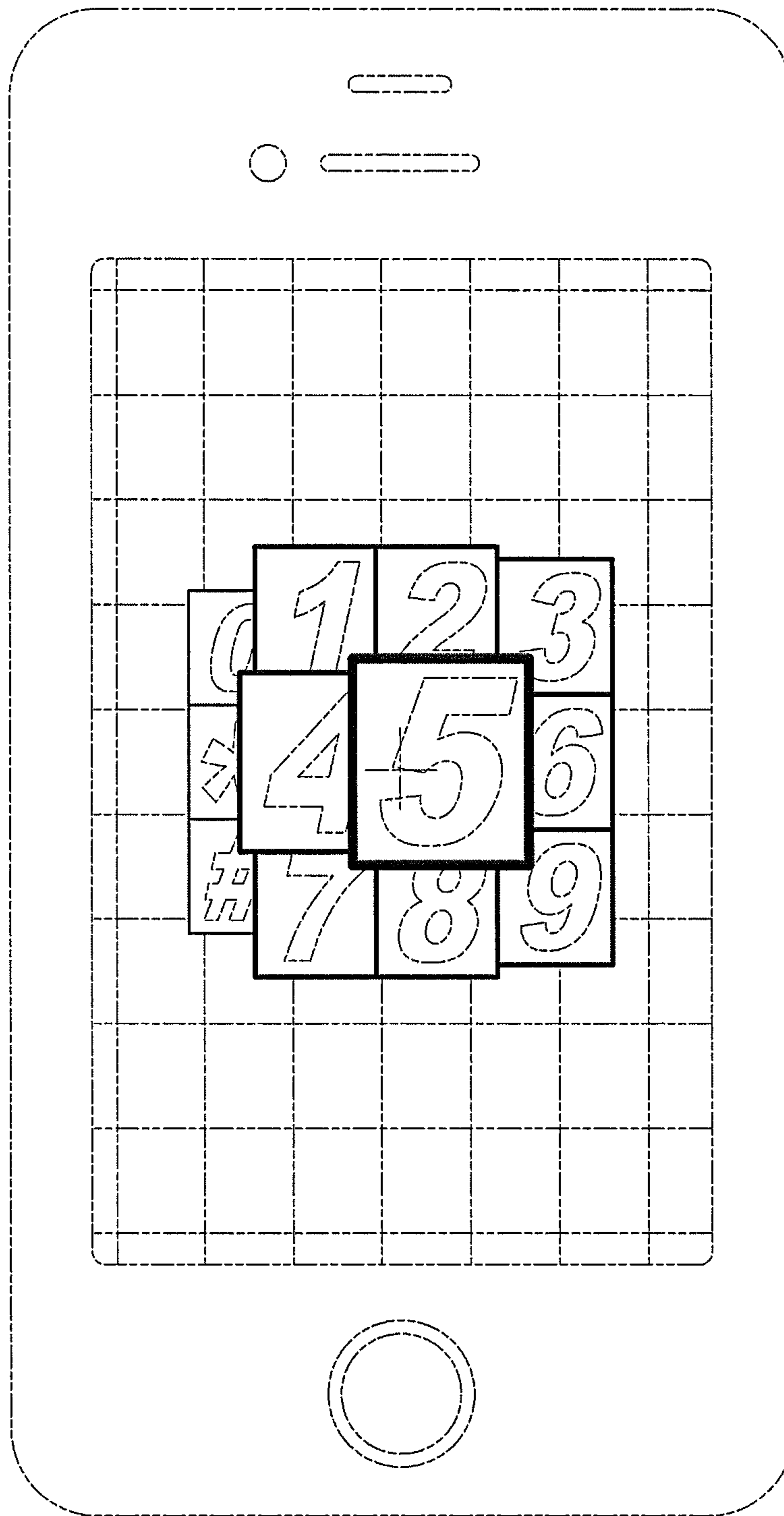

FIG. 11

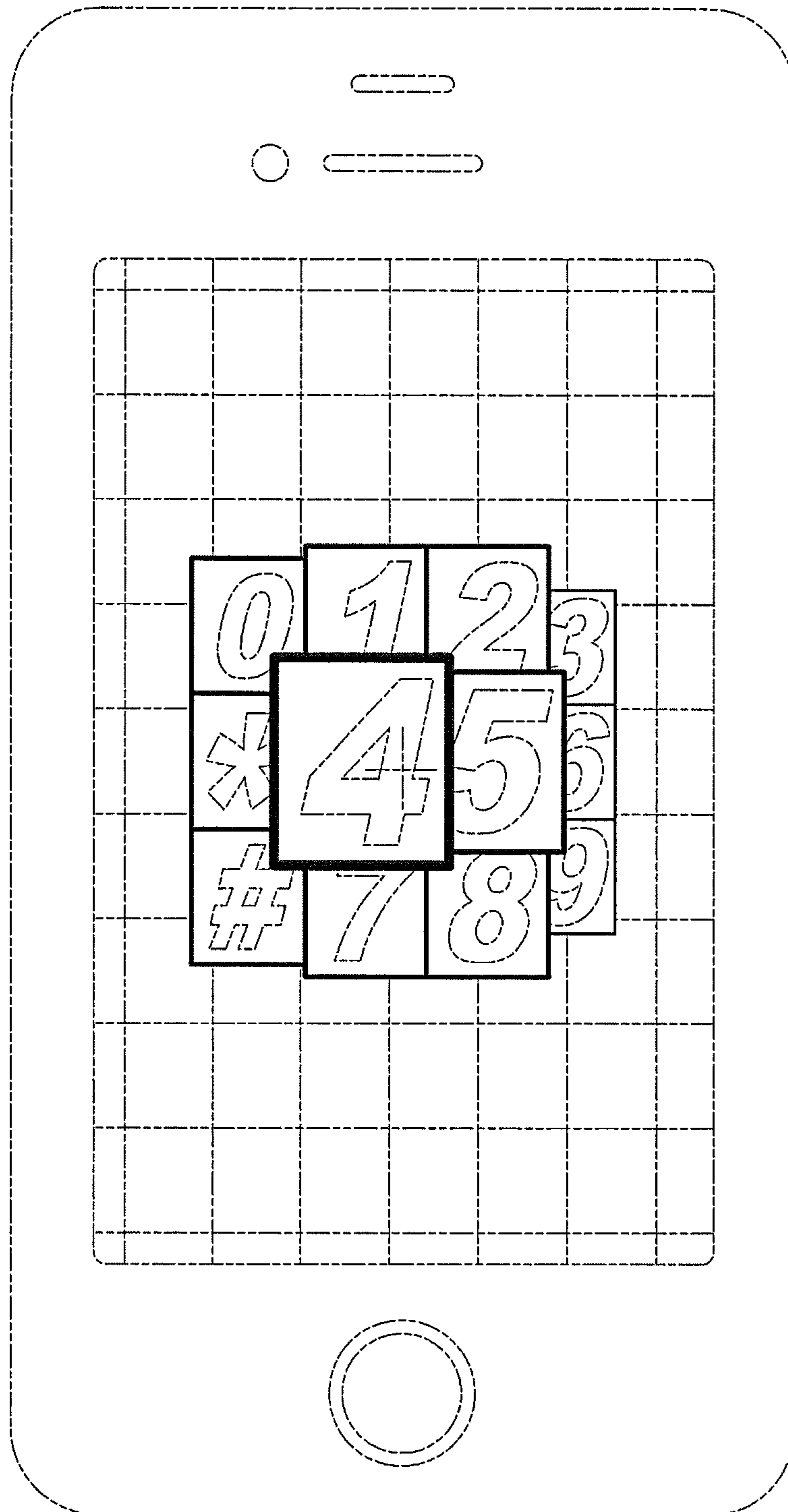

FIG. 12

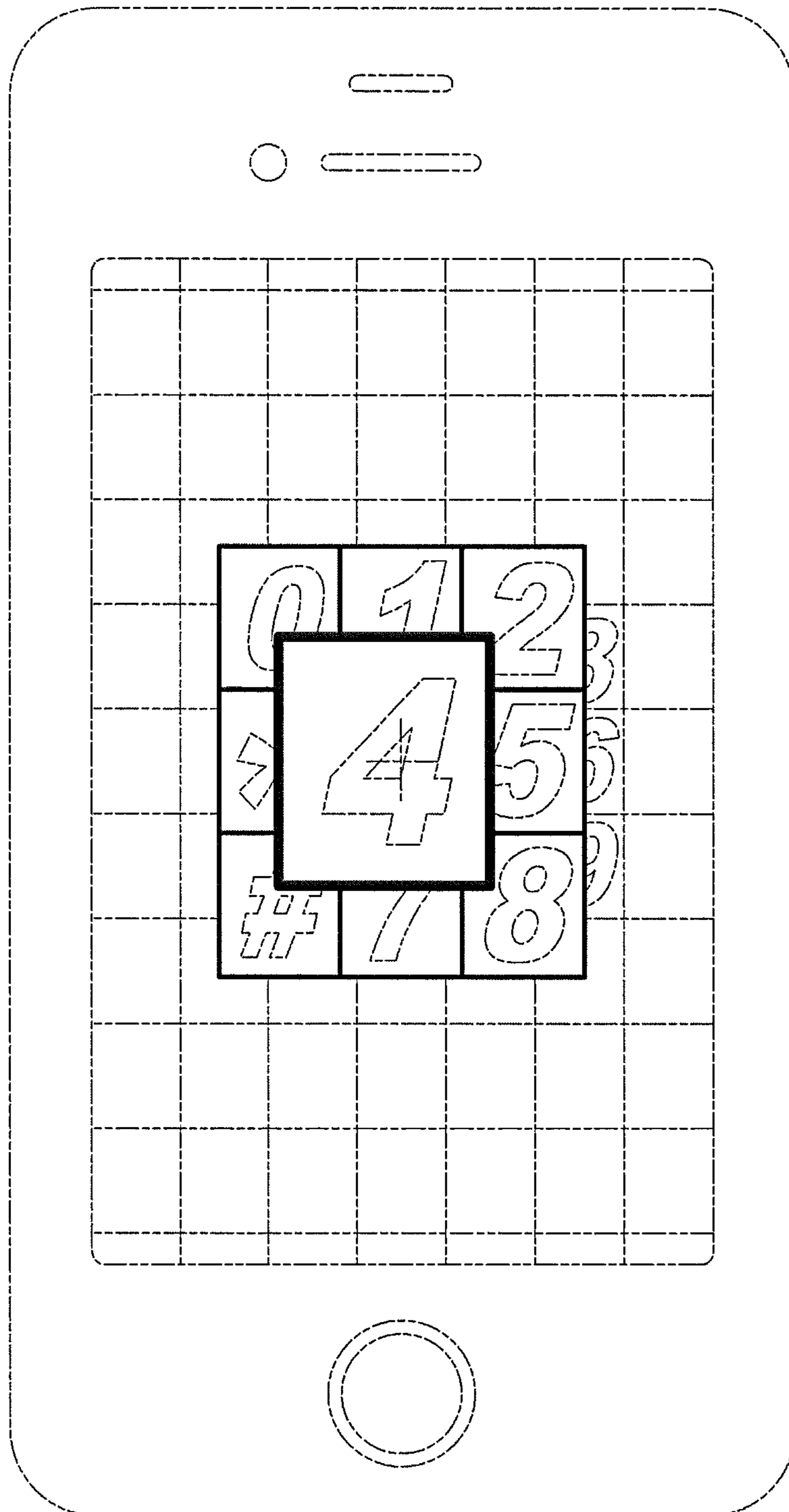

FIG. 13

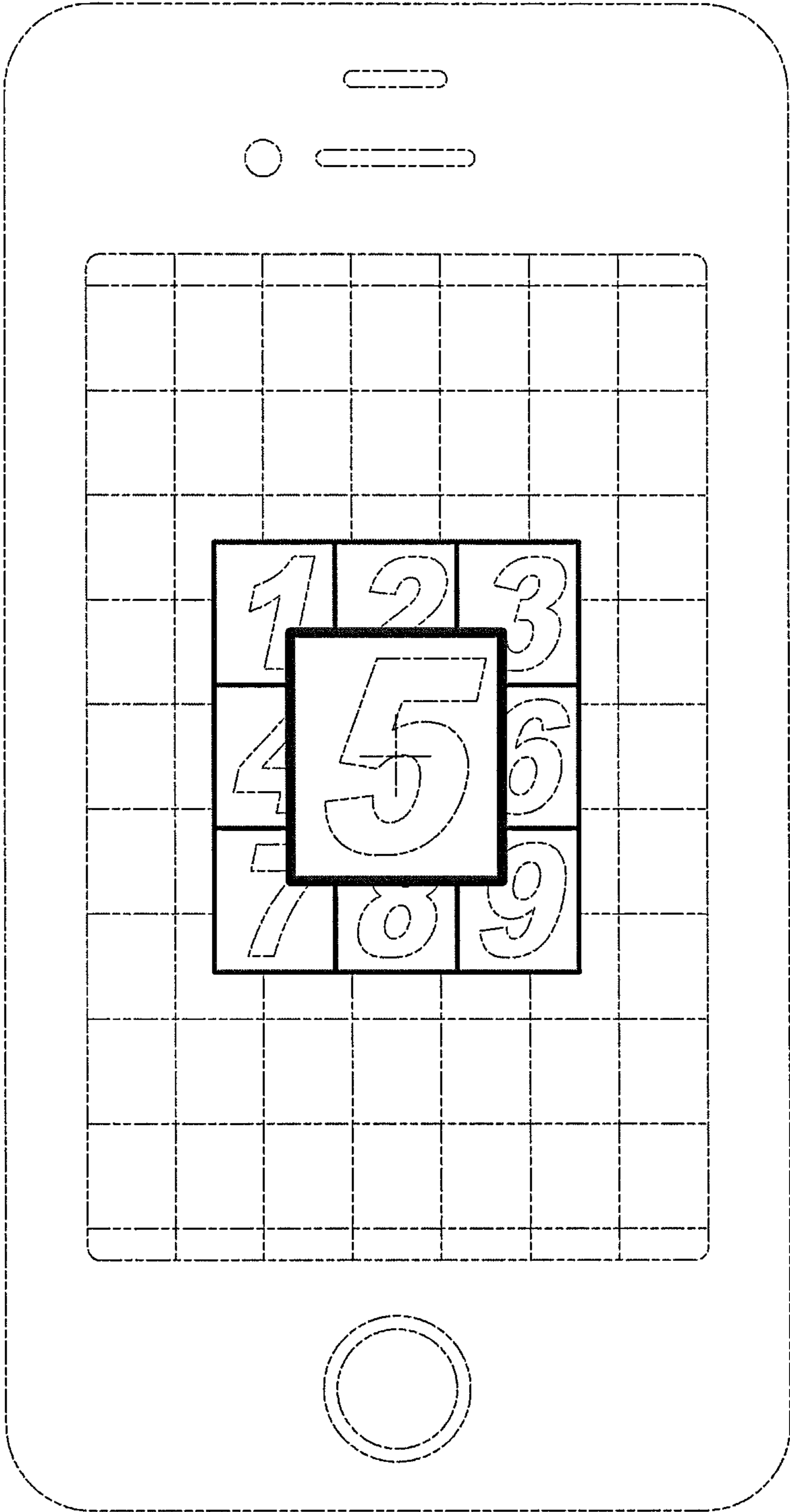

FIG. 14

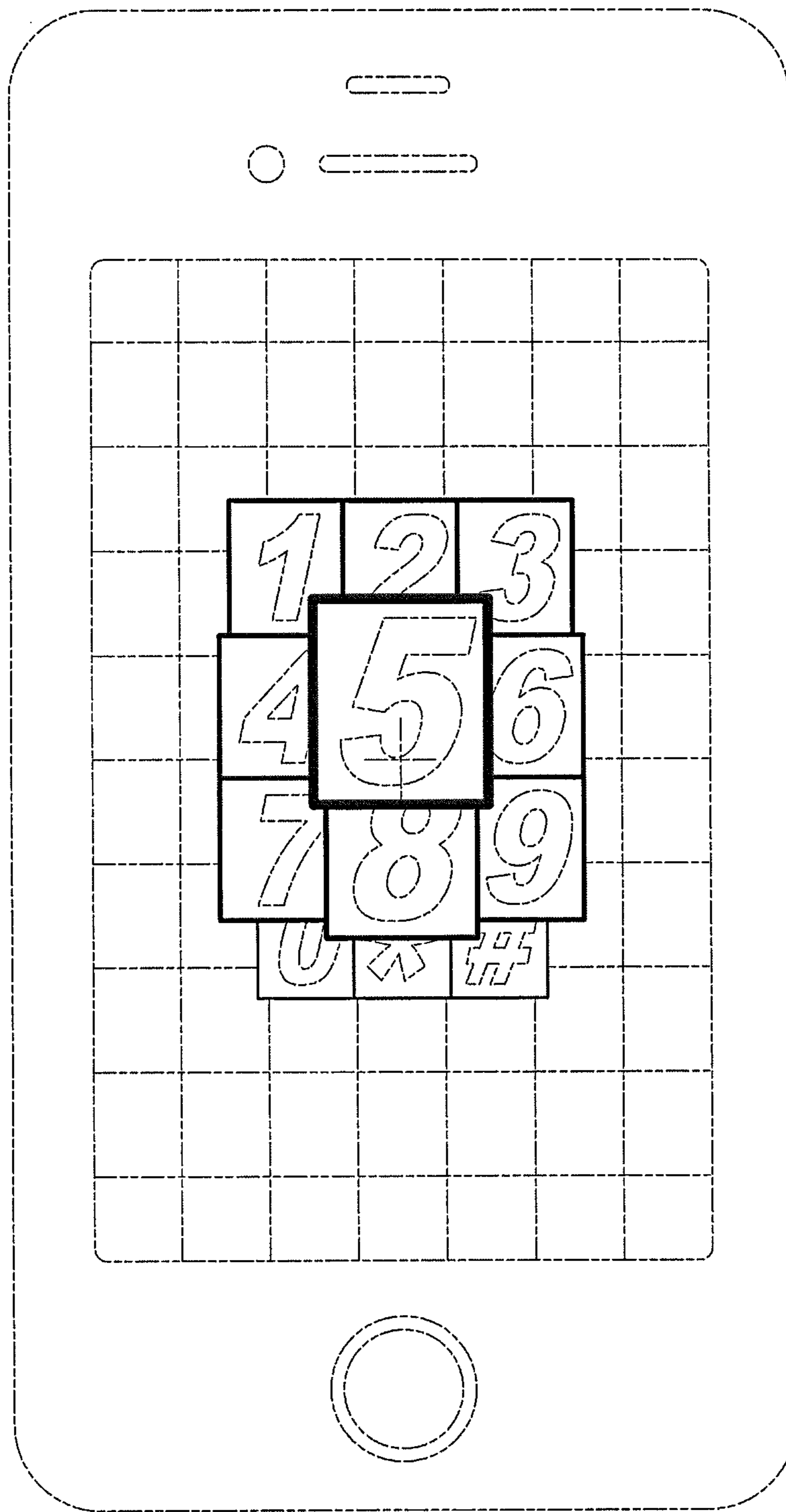

FIG. 15

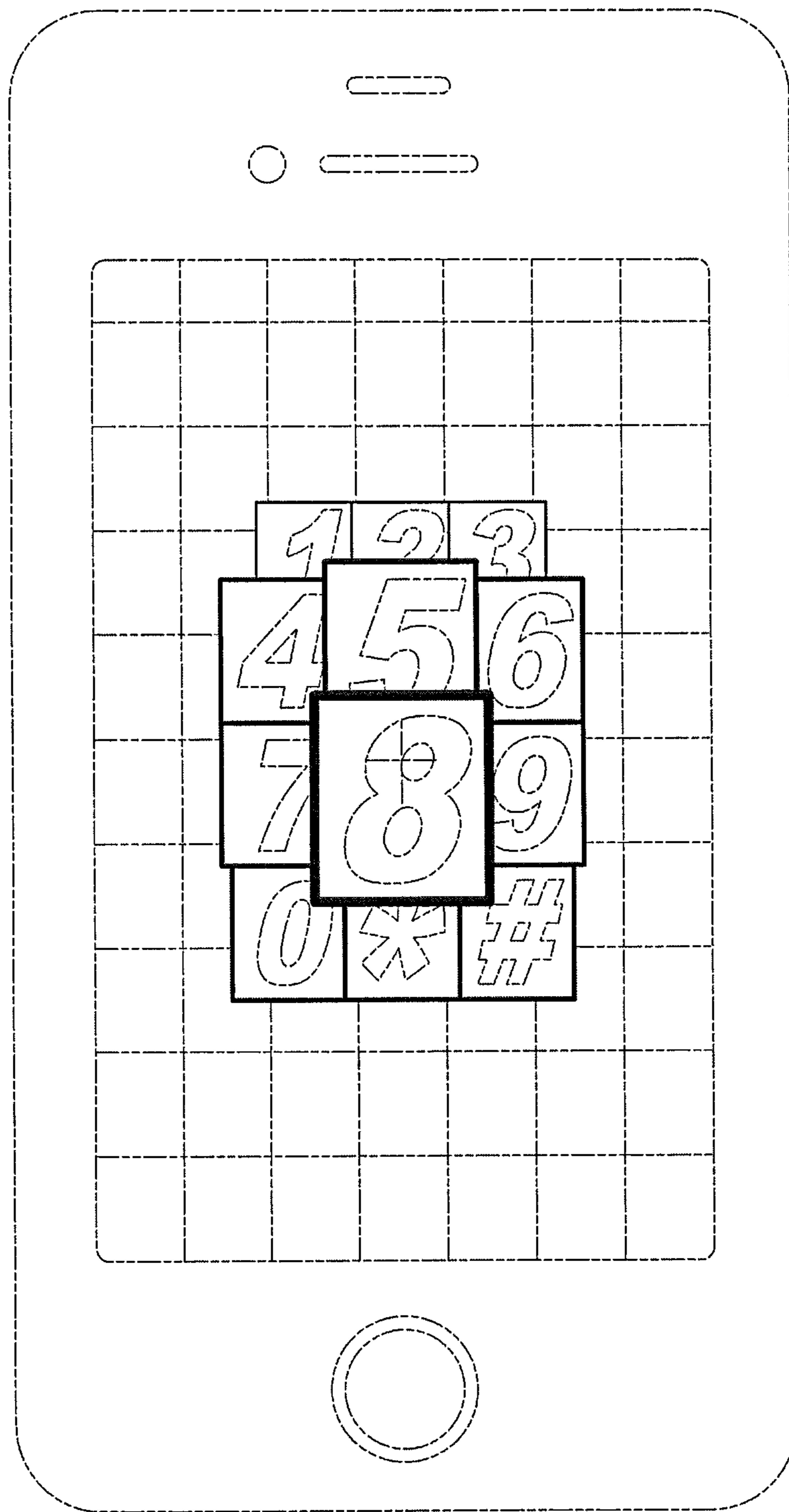

FIG. 16

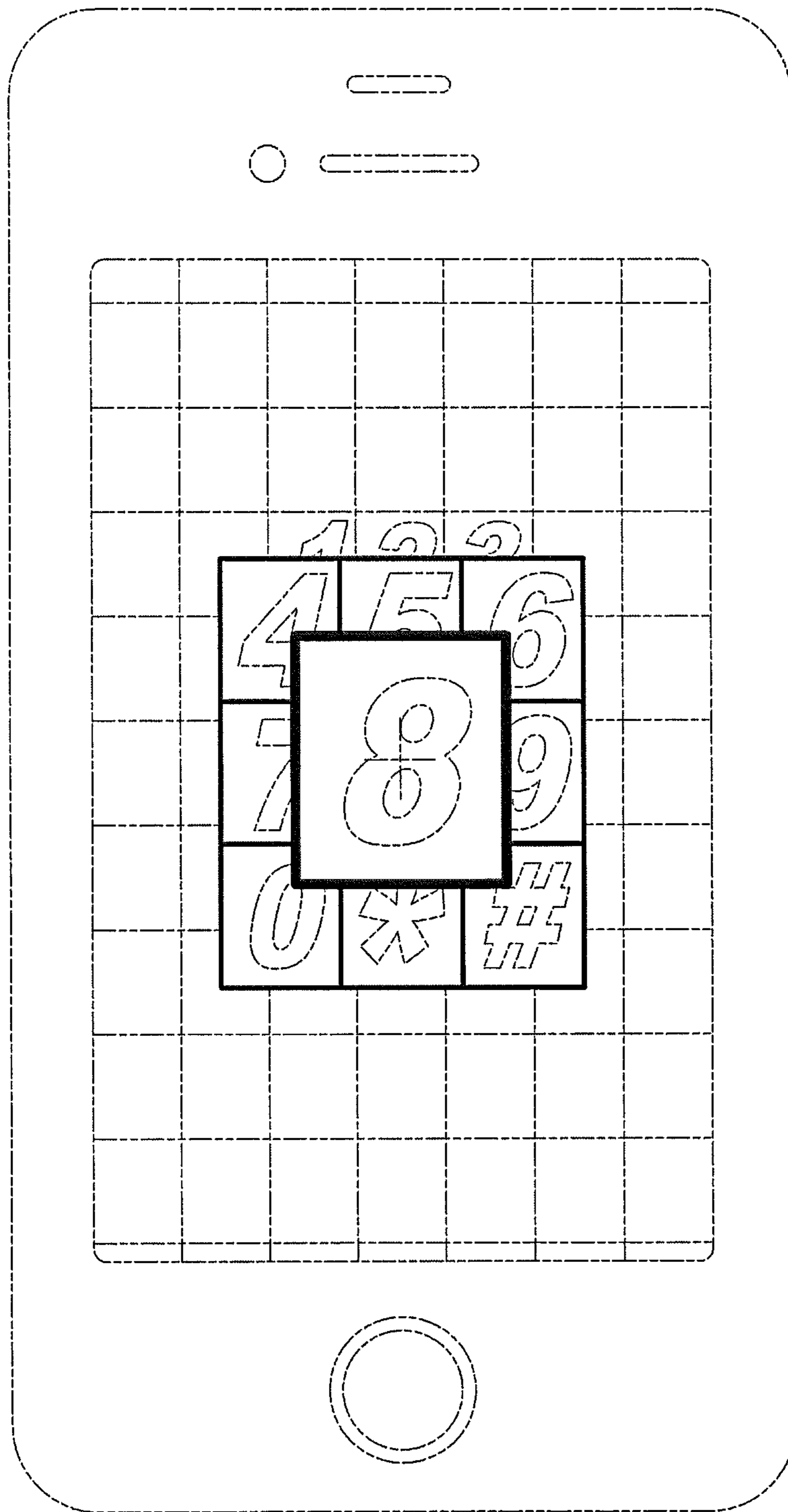

FIG. 17

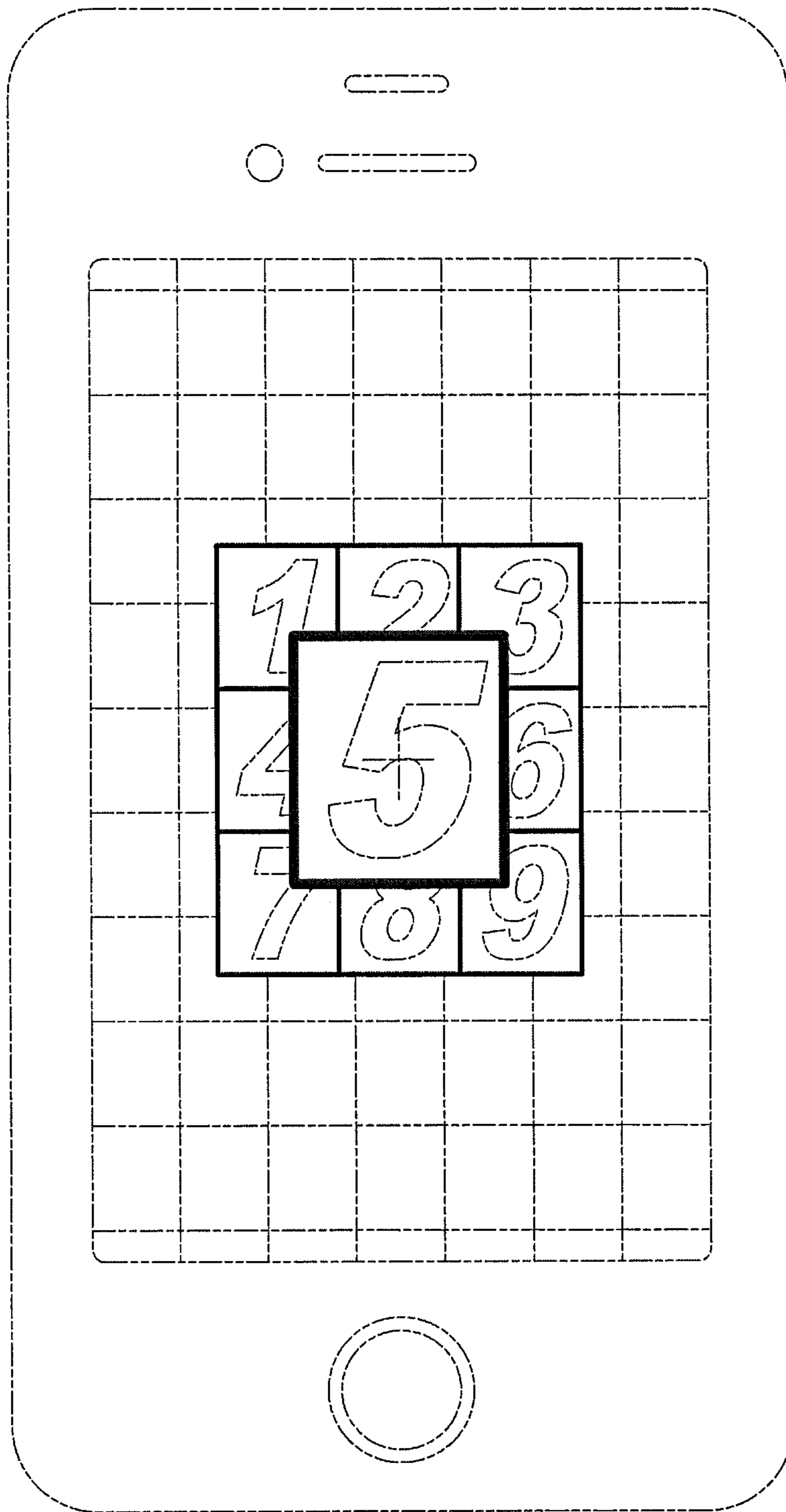

FIG. 18

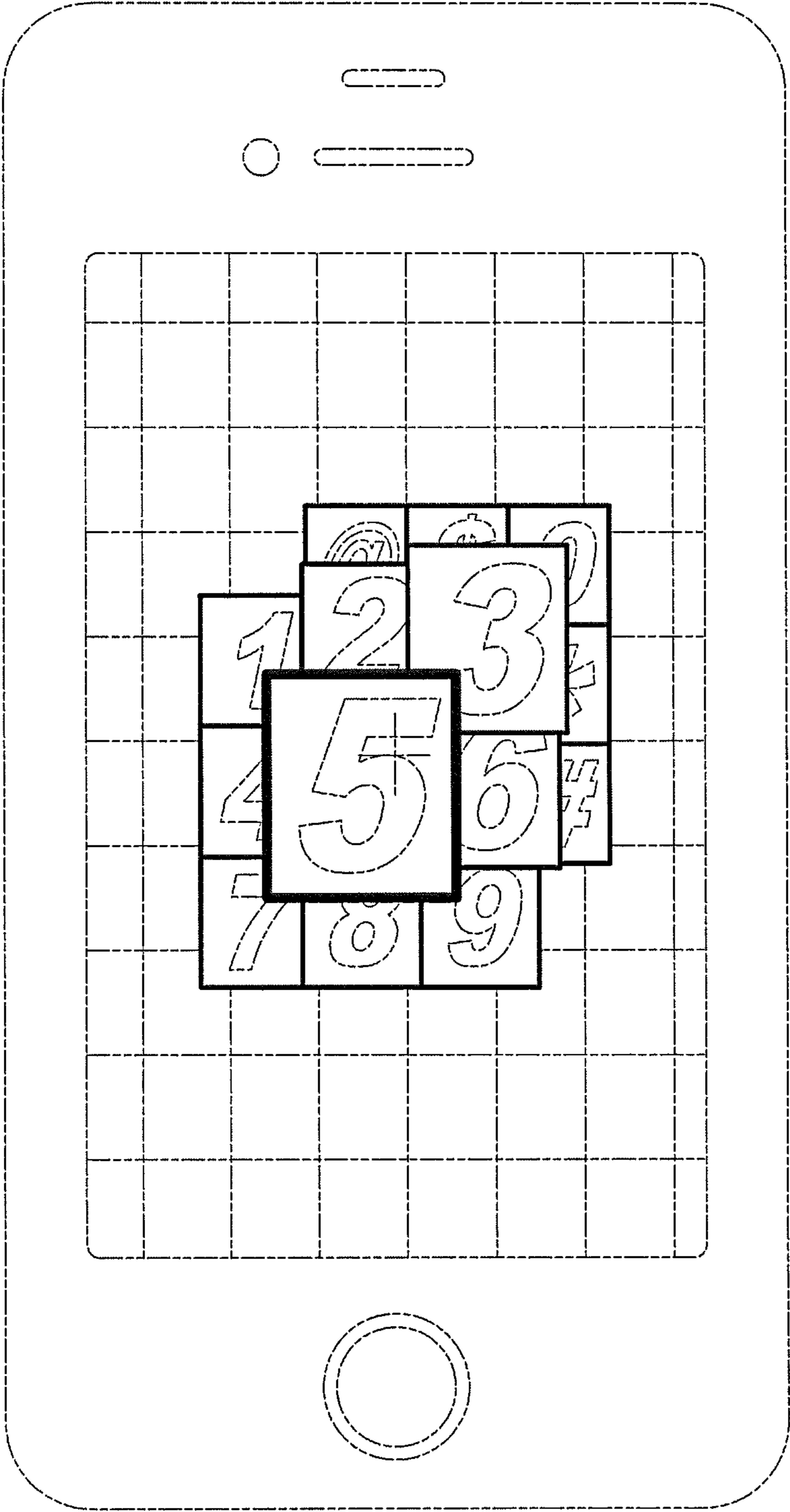

FIG. 19

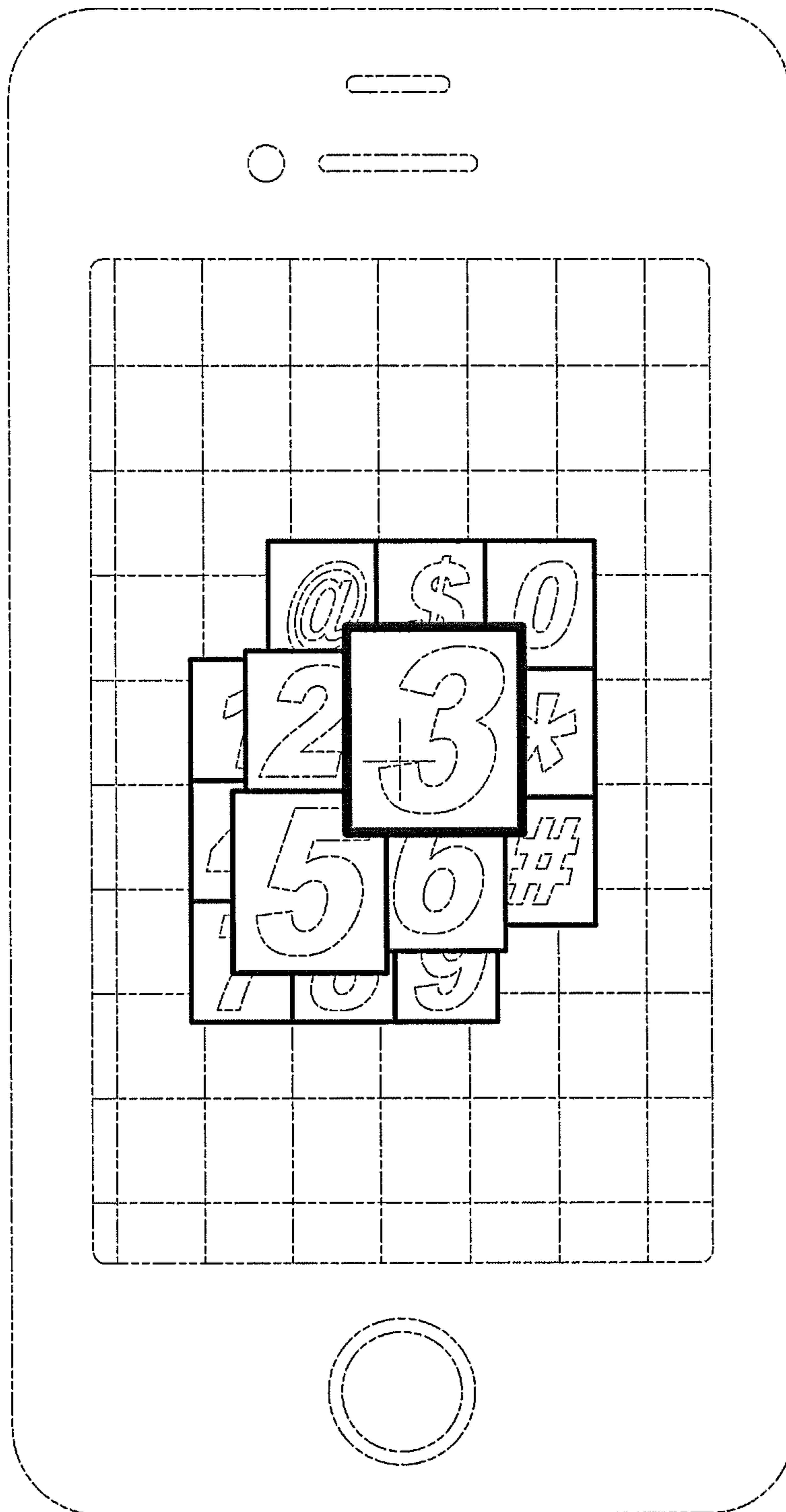

FIG. 20

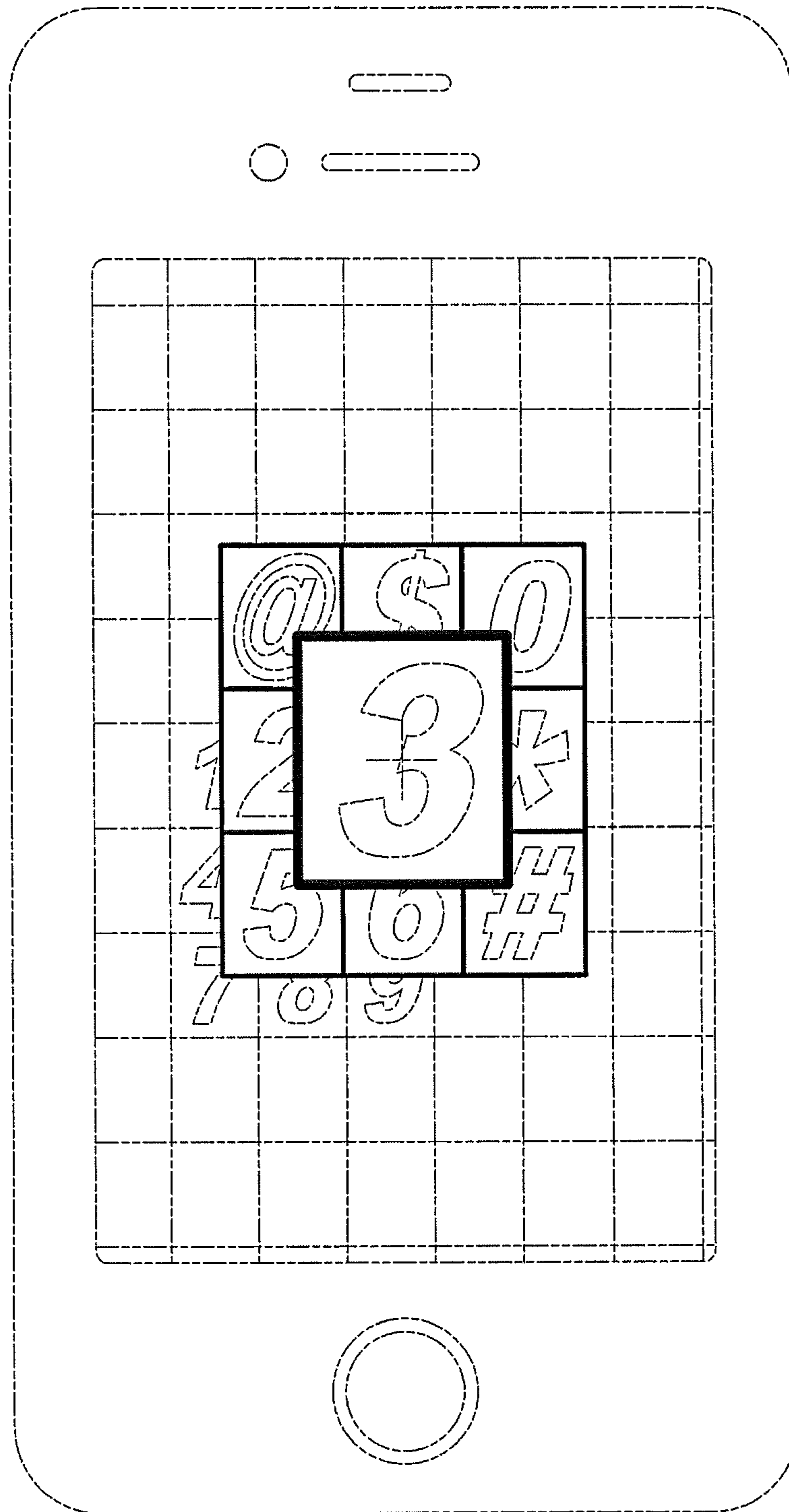

FIG. 21

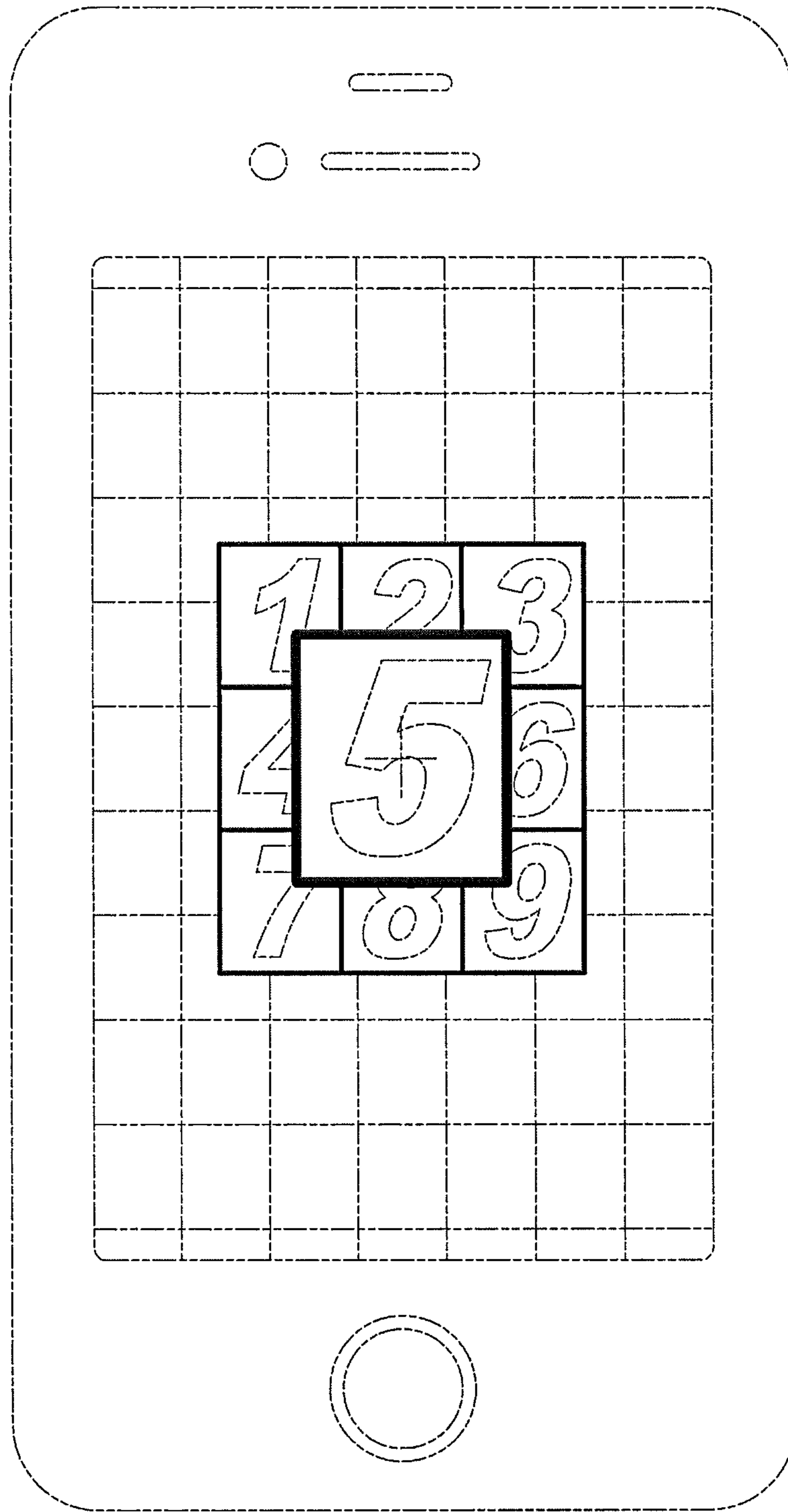

FIG. 22

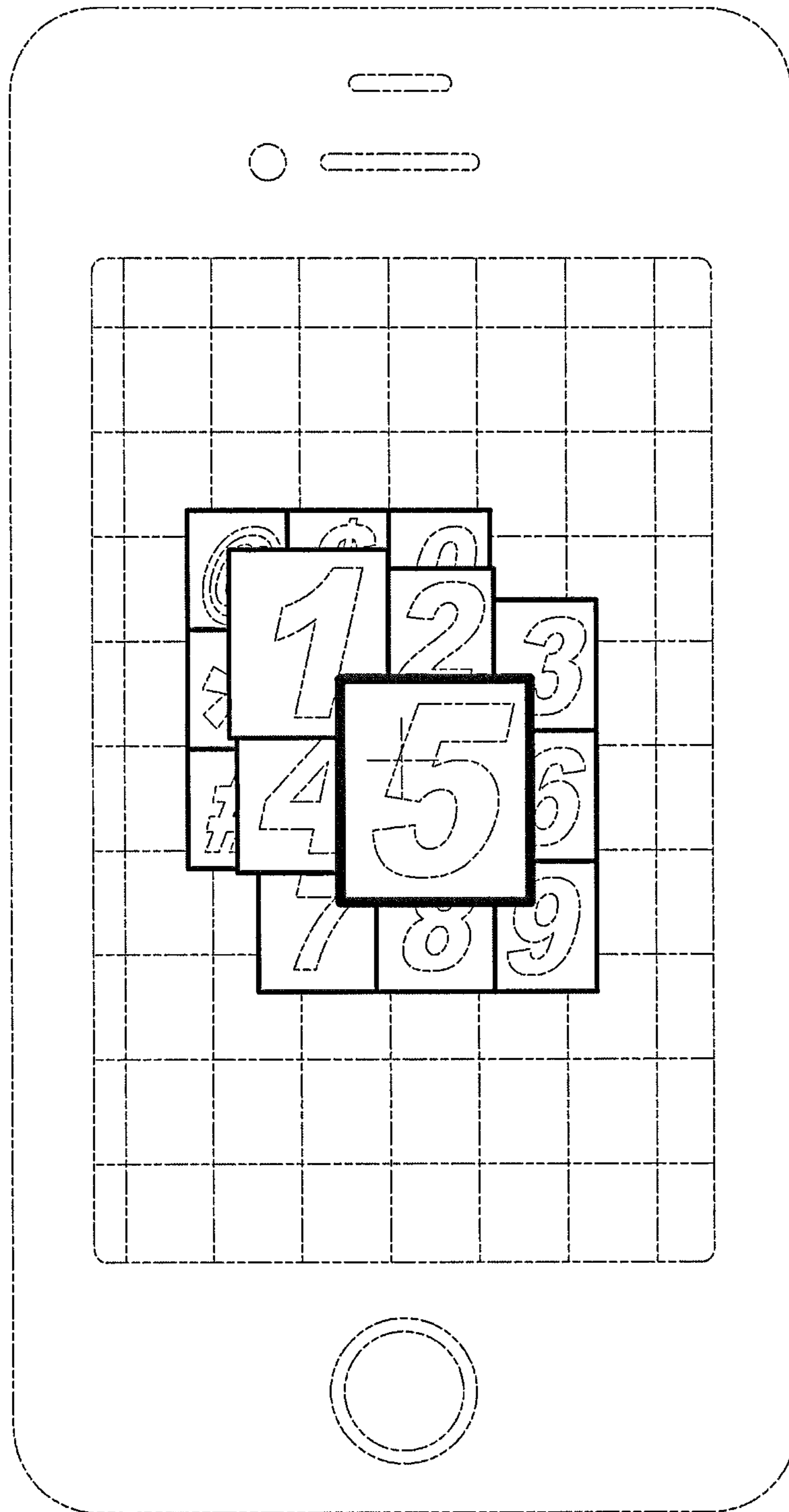

FIG. 23

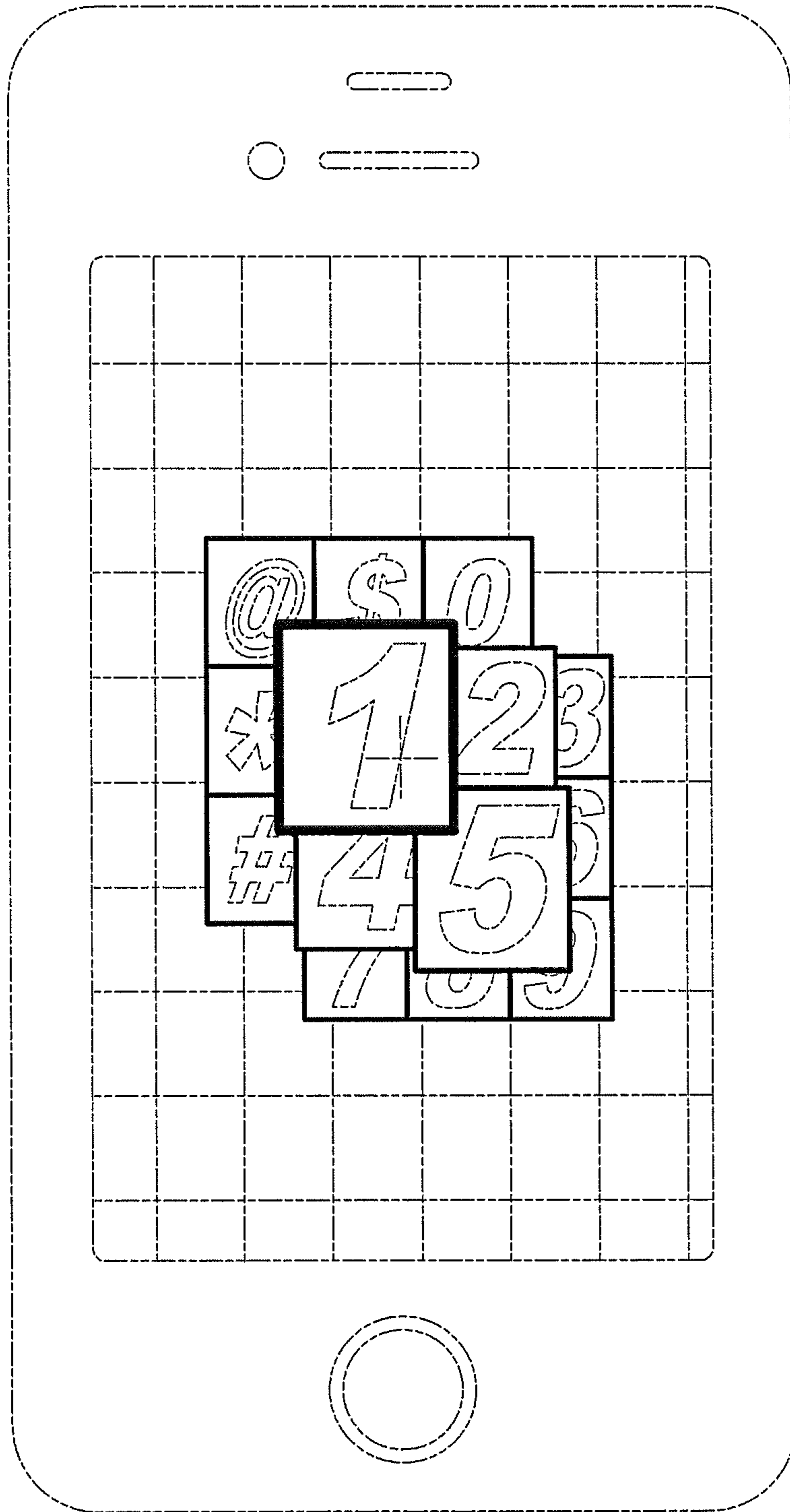

FIG. 24

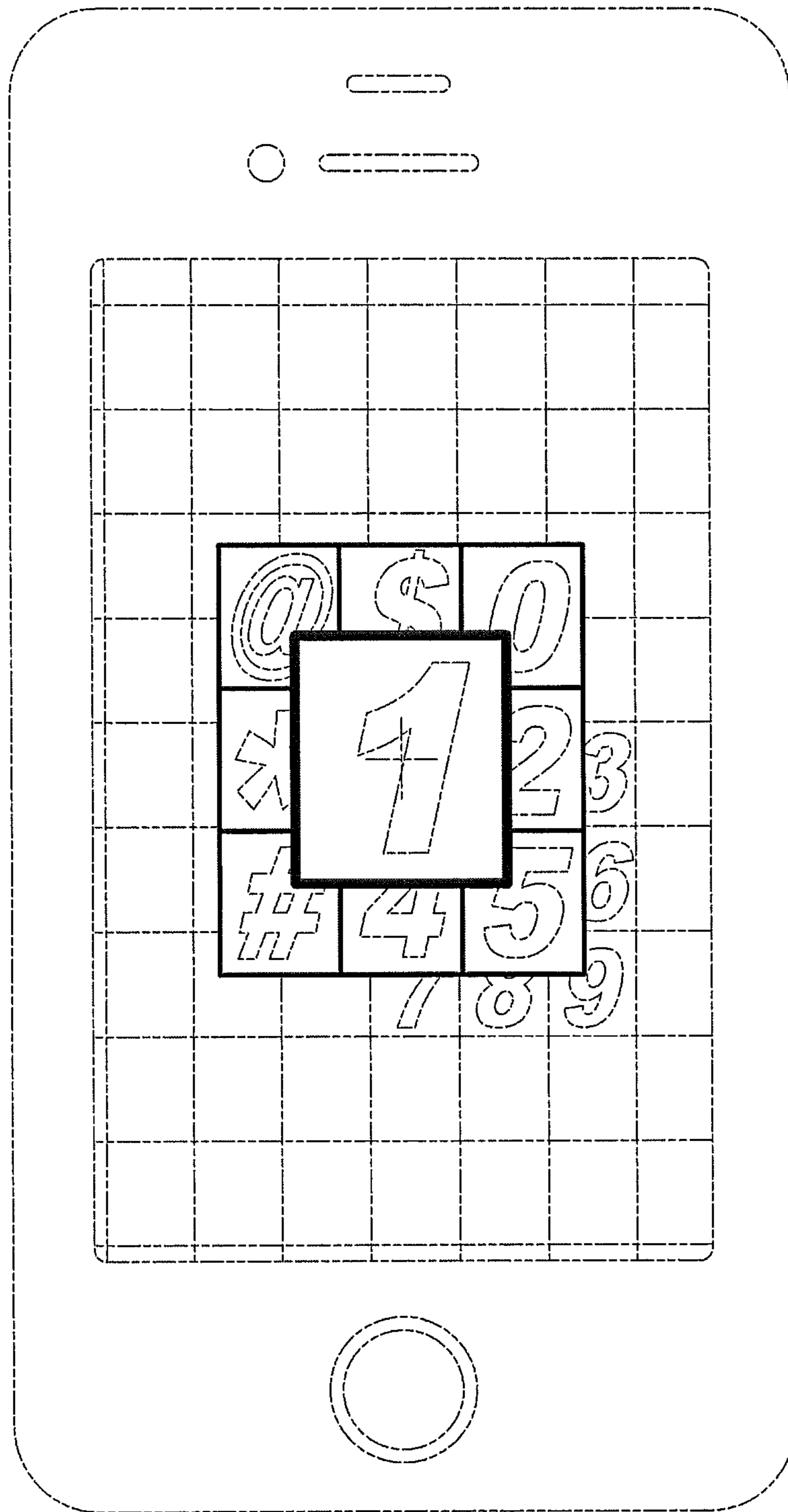

FIG. 25

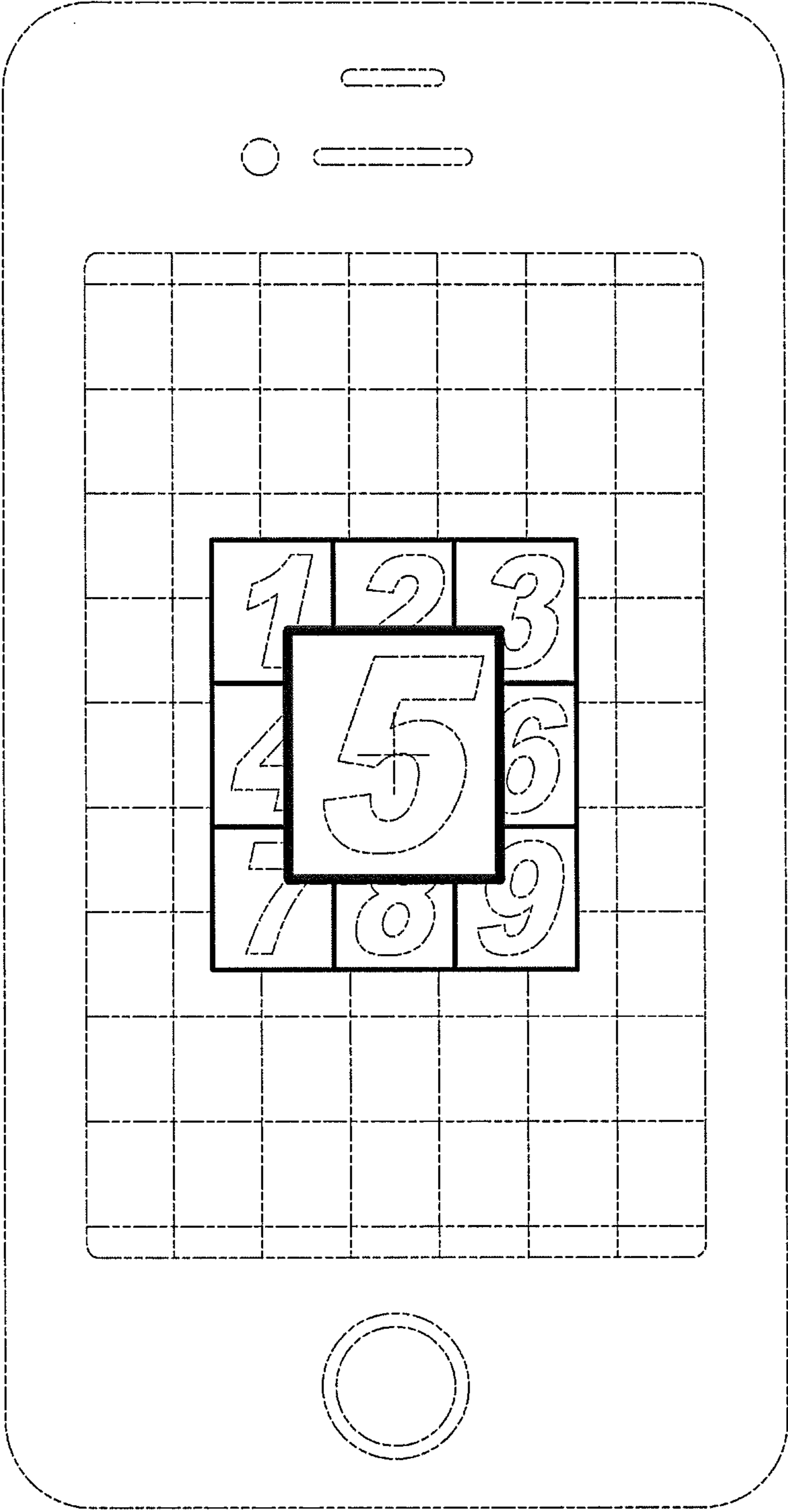

FIG. 26

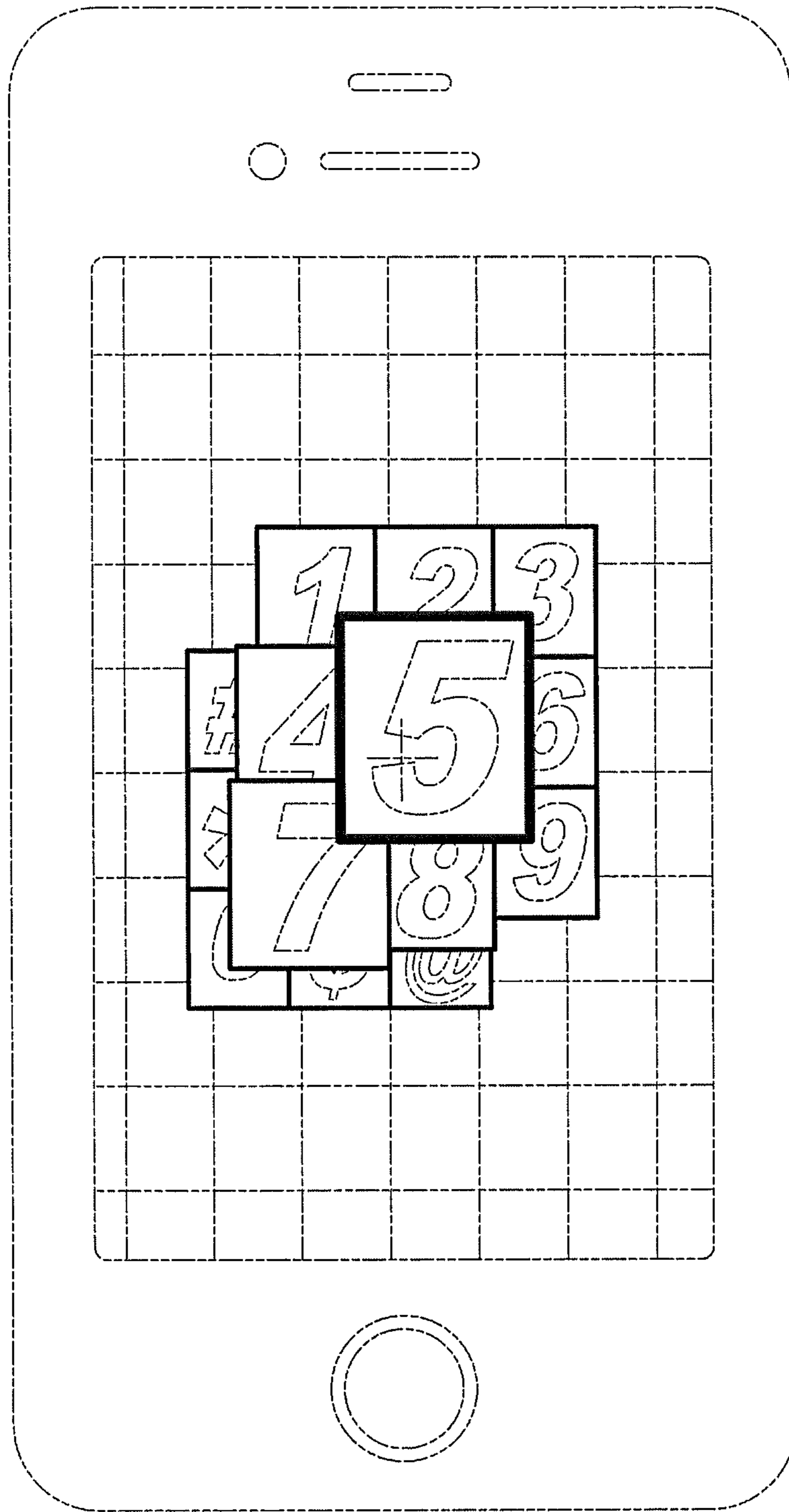

FIG. 27

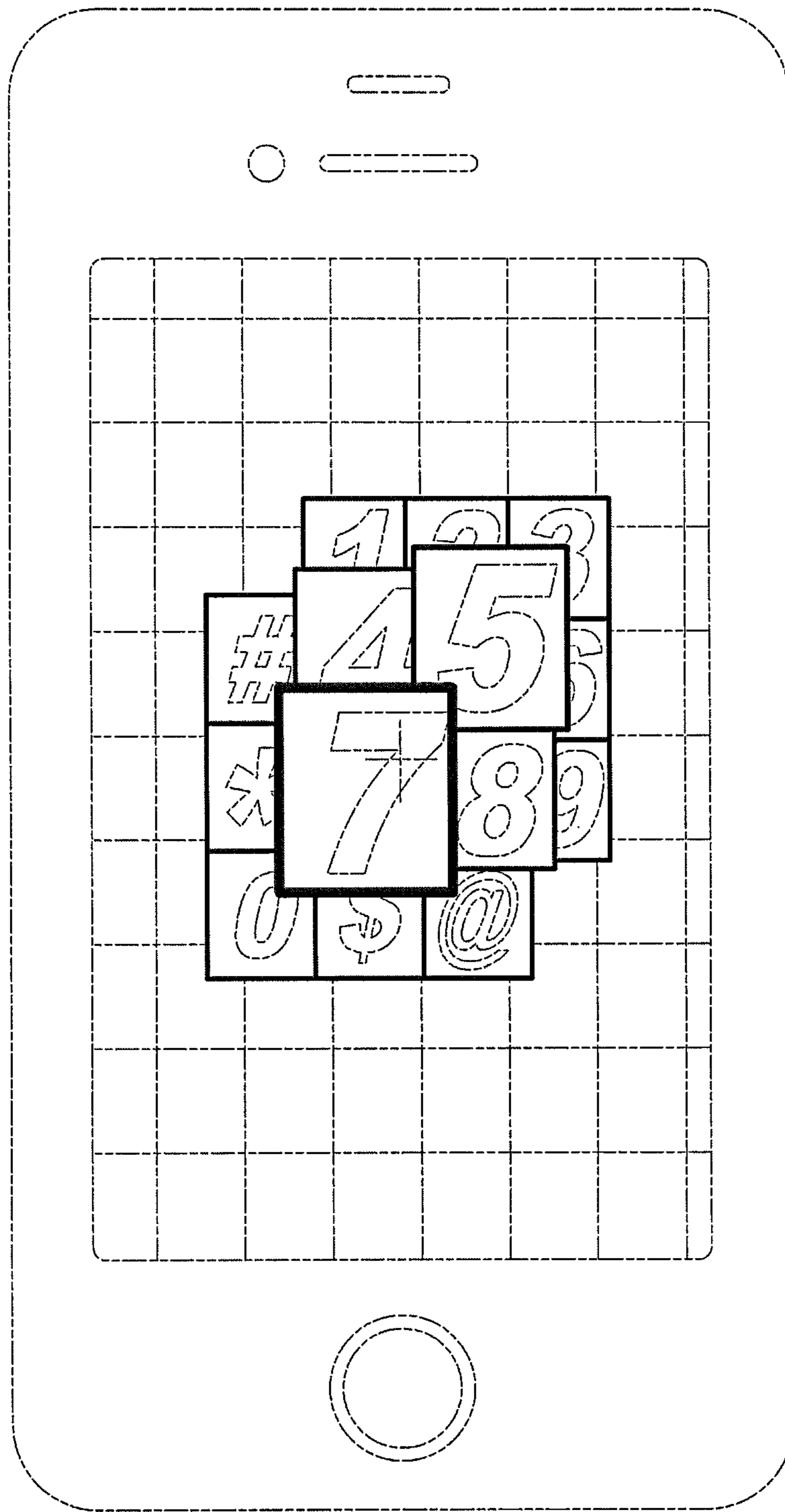

FIG. 28

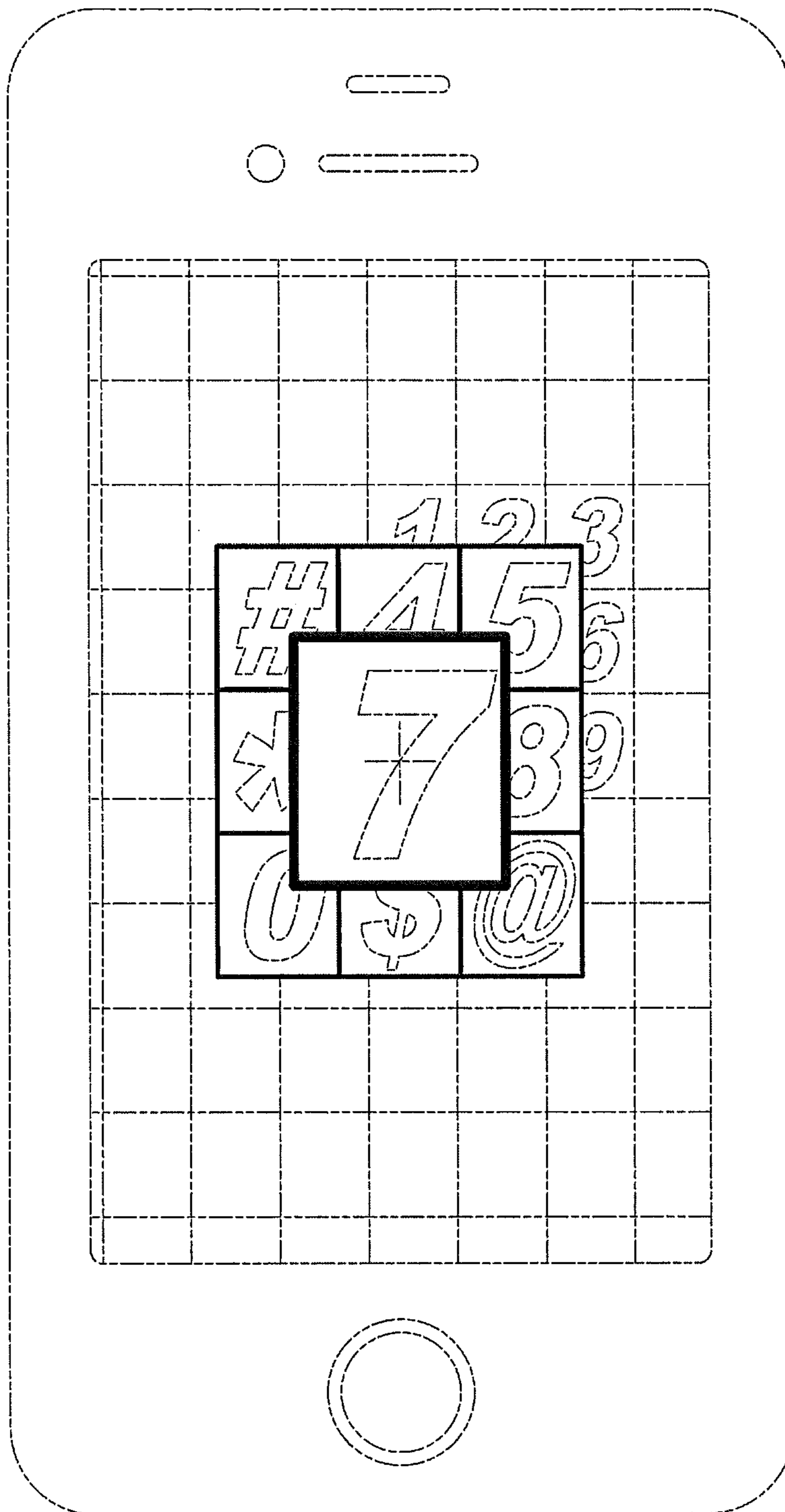

FIG. 29

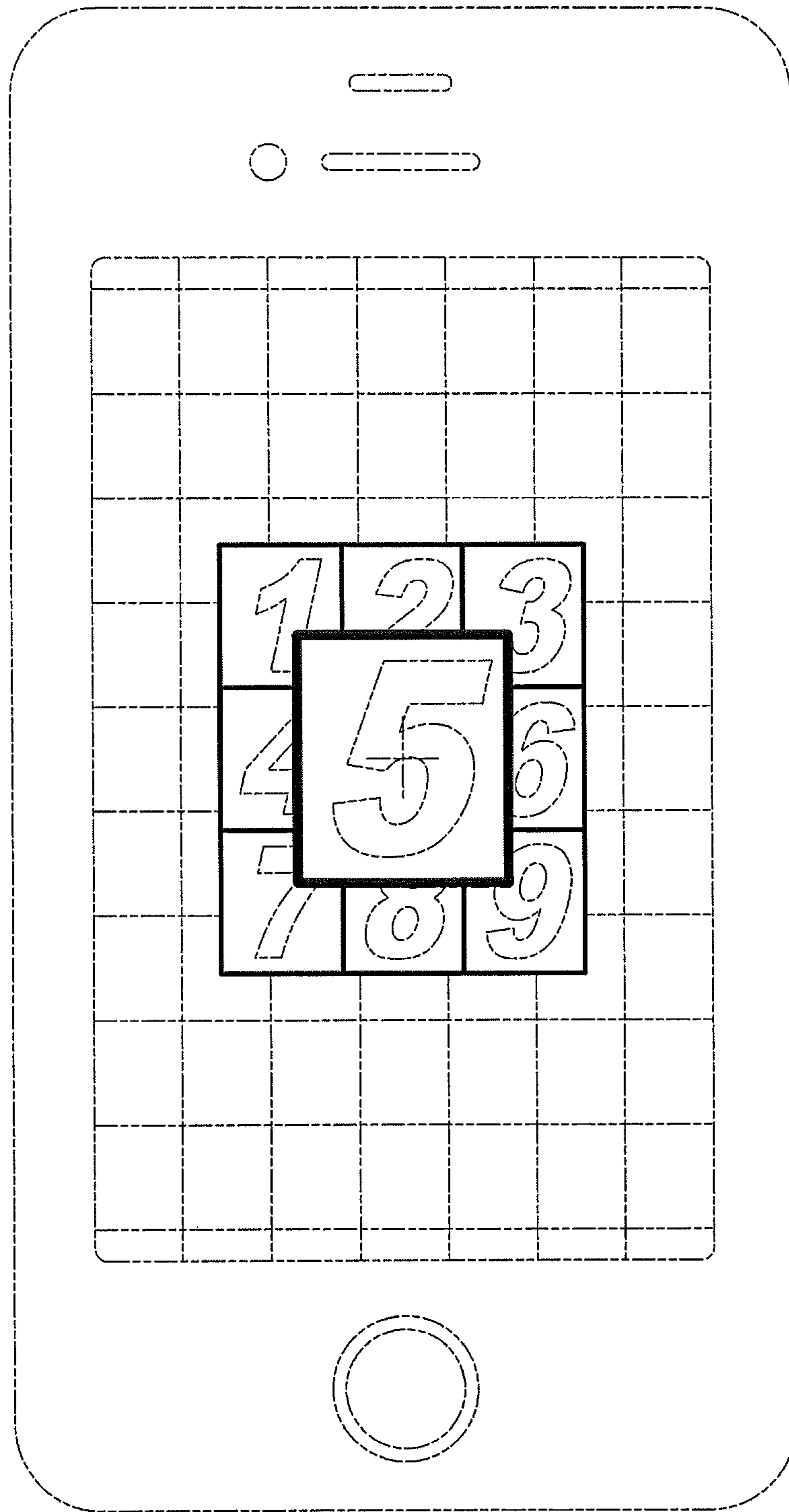

FIG. 30

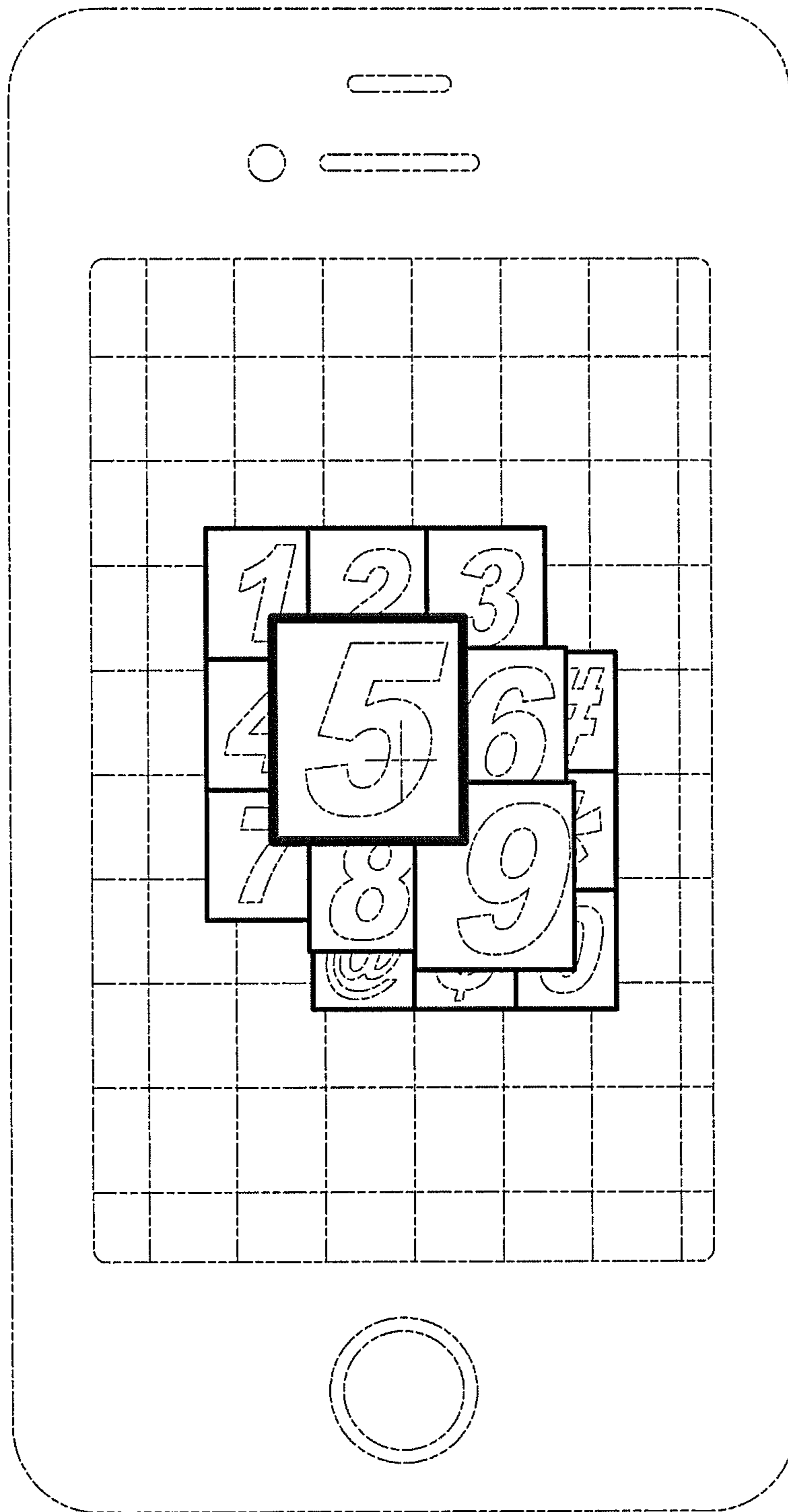

FIG. 31

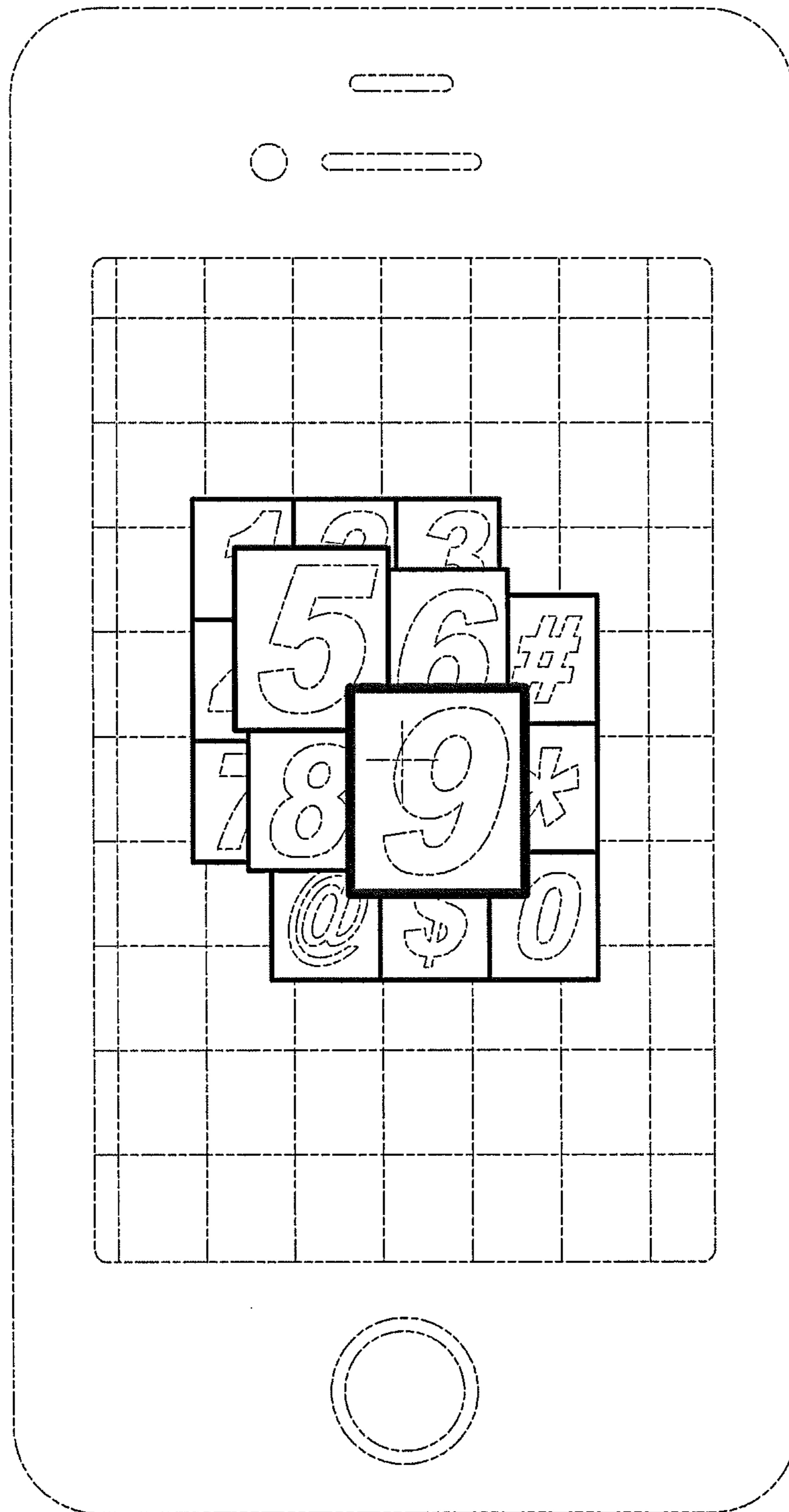

FIG. 32

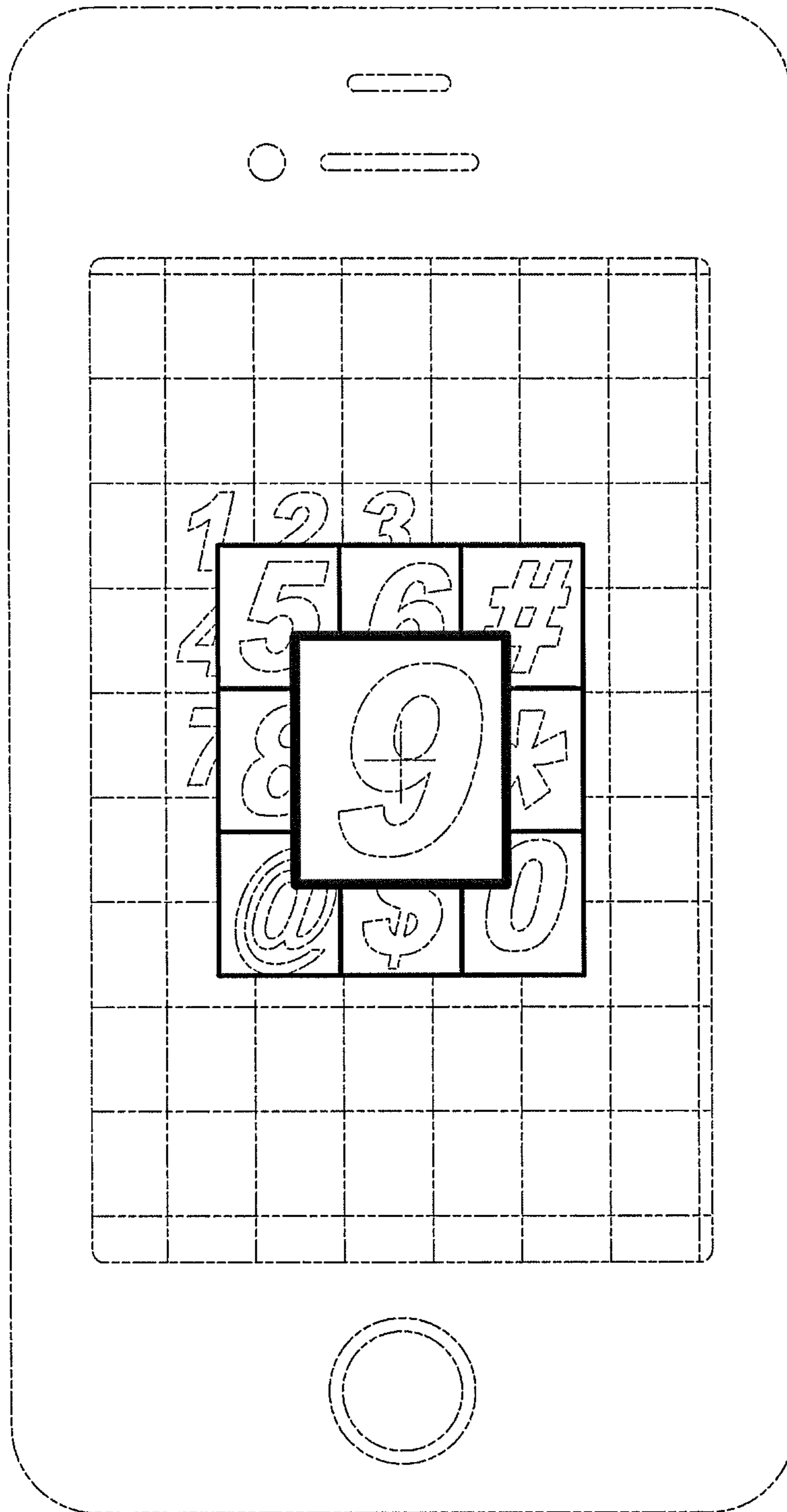

FIG. 33