



US00D704706S

(12) **United States Design Patent**  
**Serota**

(10) **Patent No.:** **US D704,706 S**

(45) **Date of Patent:** **\*\* May 13, 2014**

- (54) **HEADSET WITH DISPLAY**
- (71) Applicant: **Lee Serota**, Oswego, IL (US)
- (72) Inventor: **Lee Serota**, Oswego, IL (US)
- (\*\*) Term: **14 Years**
- (21) Appl. No.: **29/472,797**
- (22) Filed: **Nov. 15, 2013**
- (51) **LOC (10) Cl.** ..... **14-02**
- (52) **U.S. Cl.**  
USPC ..... **D14/372**
- (58) **Field of Classification Search**  
USPC ..... D14/372, 496, 432, 371, 125, 126, 129,  
D14/299; D16/300-342; 351/158, 153, 144;  
345/7-9, 905; 455/344; 348/115, 53,  
348/121, 739  
See application file for complete search history.

- D578,120 S \* 10/2008 Lowe et al. .... D14/372
- D601,641 S \* 10/2009 Yeung ..... D21/483
- D645,862 S \* 9/2011 Paul ..... D14/372
- D669,471 S \* 10/2012 Hwang et al. .... D14/372
- D687,434 S \* 8/2013 Serota ..... D14/372
- D695,739 S \* 12/2013 Kumagai et al. .... D14/372
- 2002/0171605 A1 \* 11/2002 Kim et al. .... 345/8

\* cited by examiner

*Primary Examiner* — Austin Murphy

(57) **CLAIM**

The ornamental design for a headset with display, as shown and described.

**DESCRIPTION**

FIG. 1 is a perspective view of a headset with display;  
 FIG. 2 is a front elevational view thereof;  
 FIG. 3 is a rear elevational view thereof;  
 FIG. 4 is a top plan view thereof;  
 FIG. 5 is a bottom plan view thereof;  
 FIG. 6 is a left-side elevational view thereof; and,  
 FIG. 7 is a right-side elevational view thereof.  
 The broken line showing in FIGS. 1-7 is included for the purpose of showing environmental structure and forms no part of the claimed design.

**1 Claim, 7 Drawing Sheets**

(56) **References Cited**

U.S. PATENT DOCUMENTS

- D338,514 S \* 8/1993 Holmes ..... D14/372
- D369,595 S \* 5/1996 Kober et al. .... D14/372
- D440,967 S \* 4/2001 Jung ..... D14/372
- D571,366 S \* 6/2008 Lee et al. .... D14/372

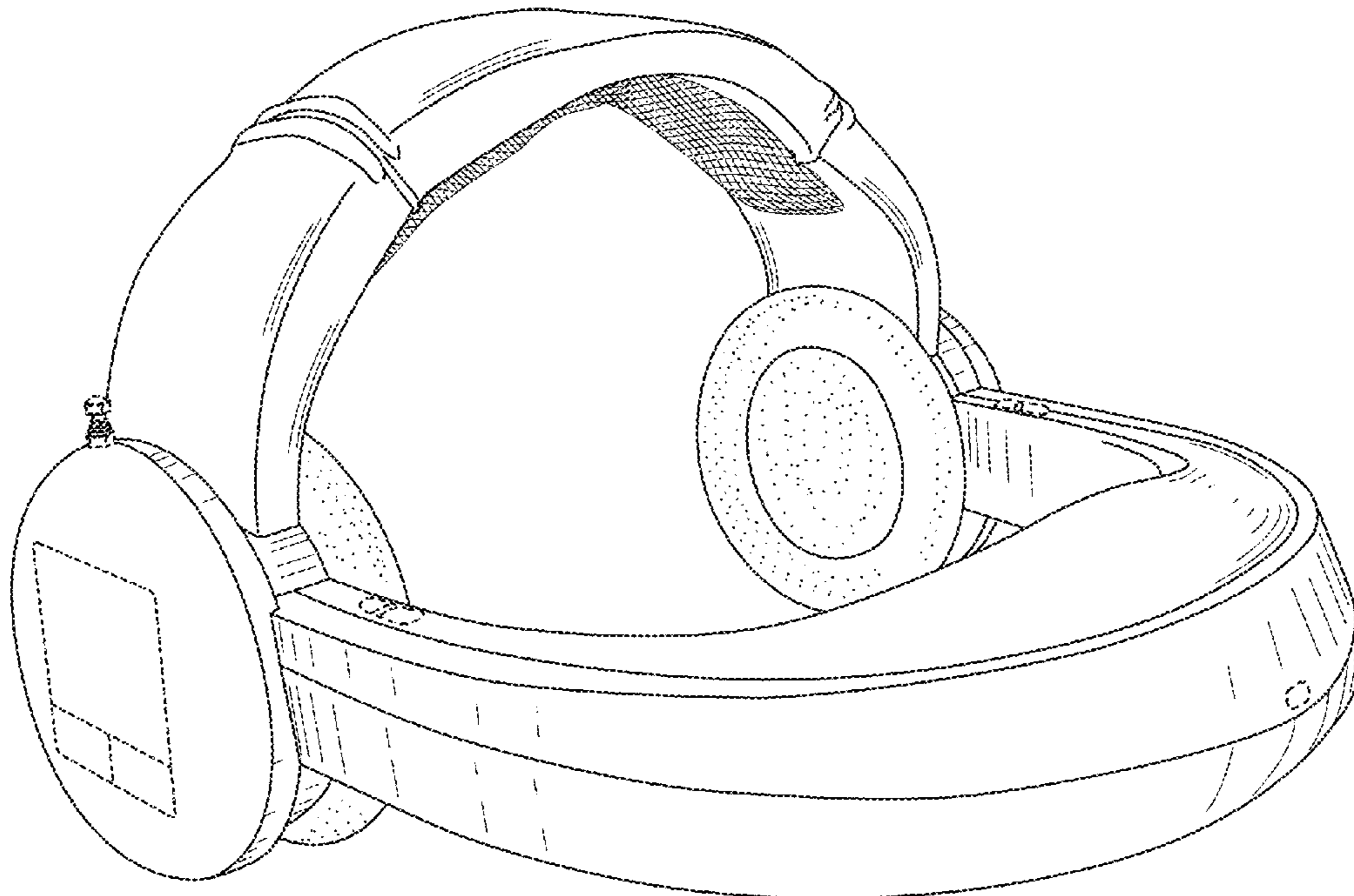

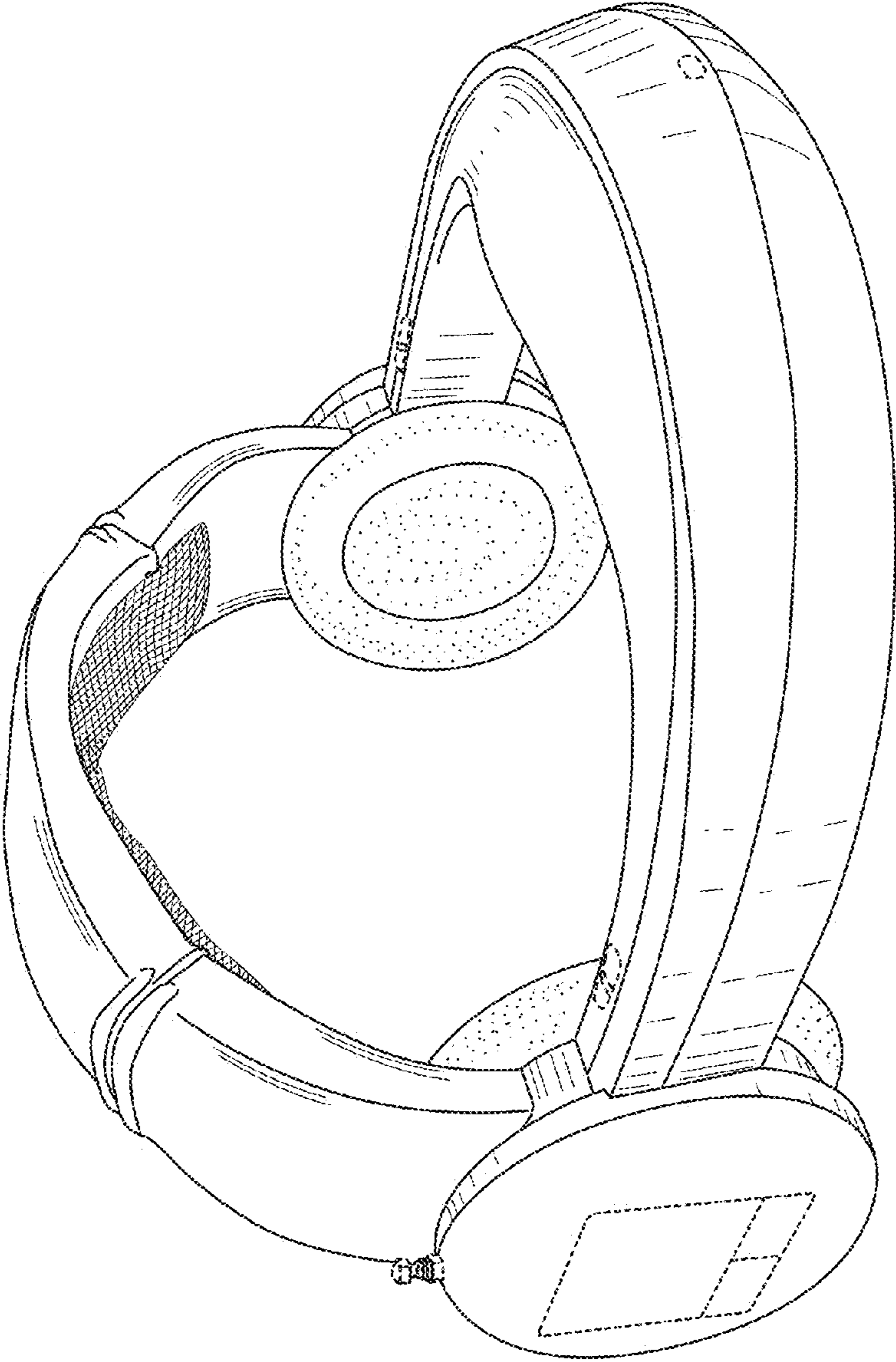

FIG. 1

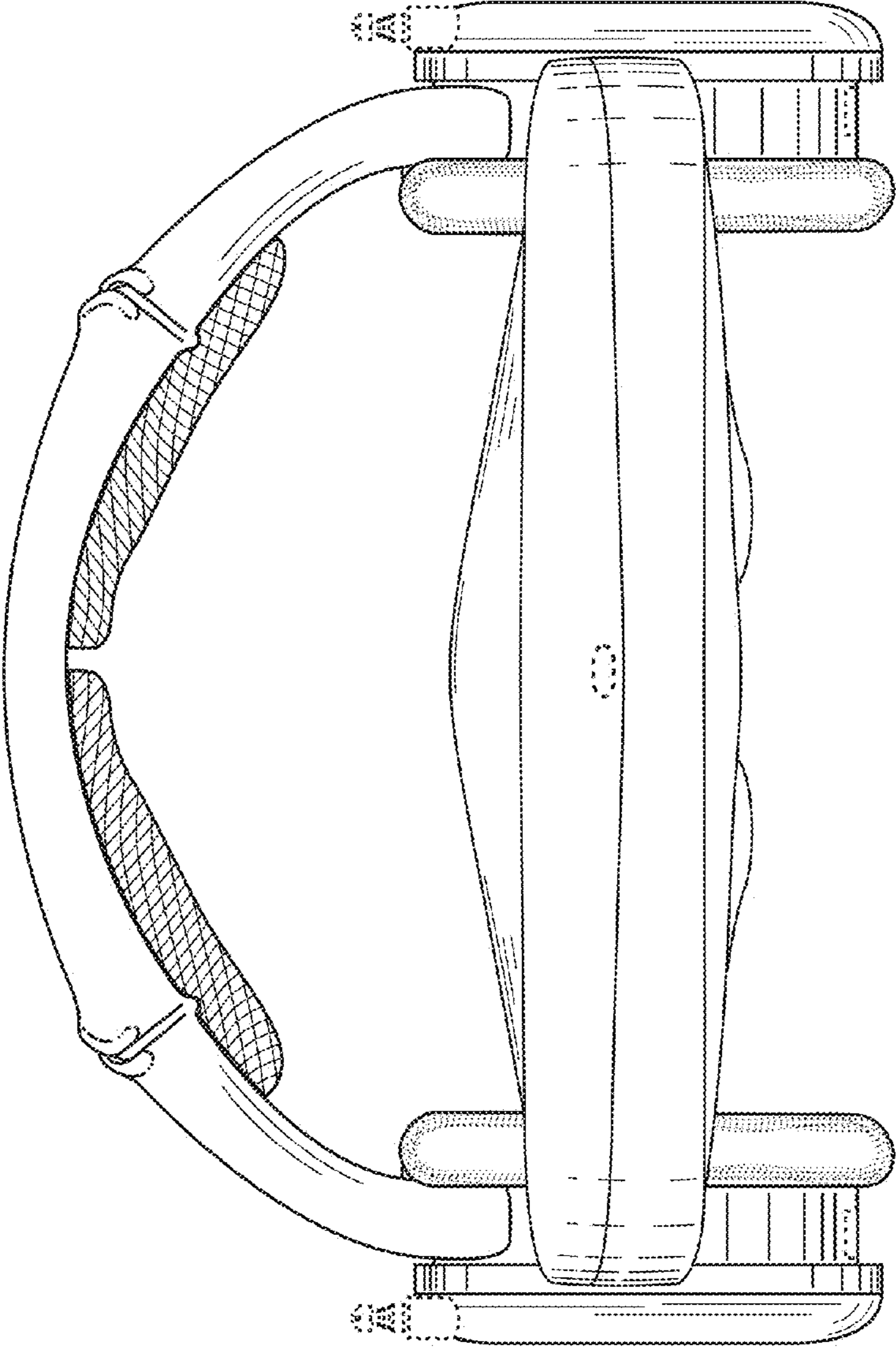

FIG. 2

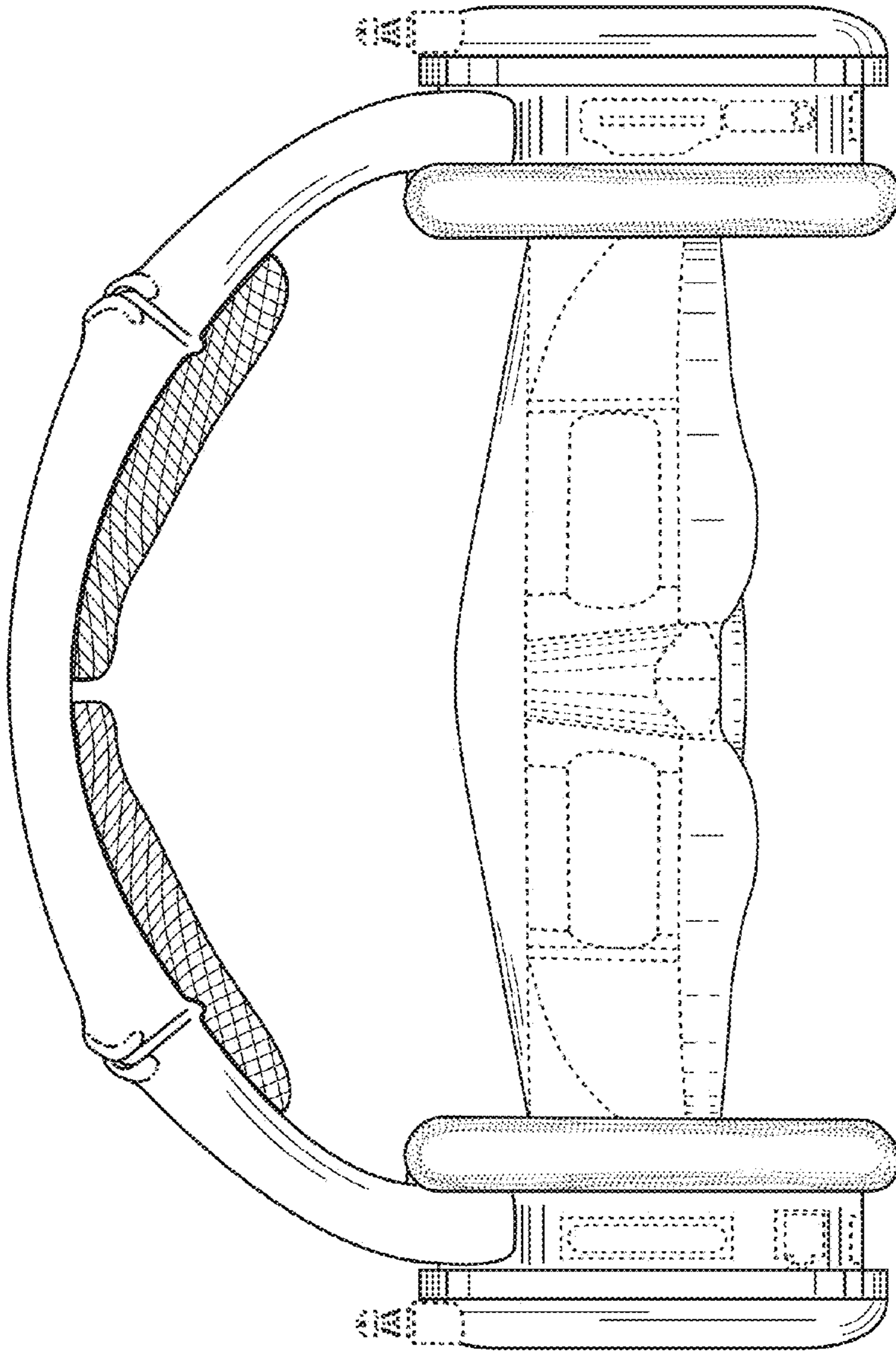

FIG. 3



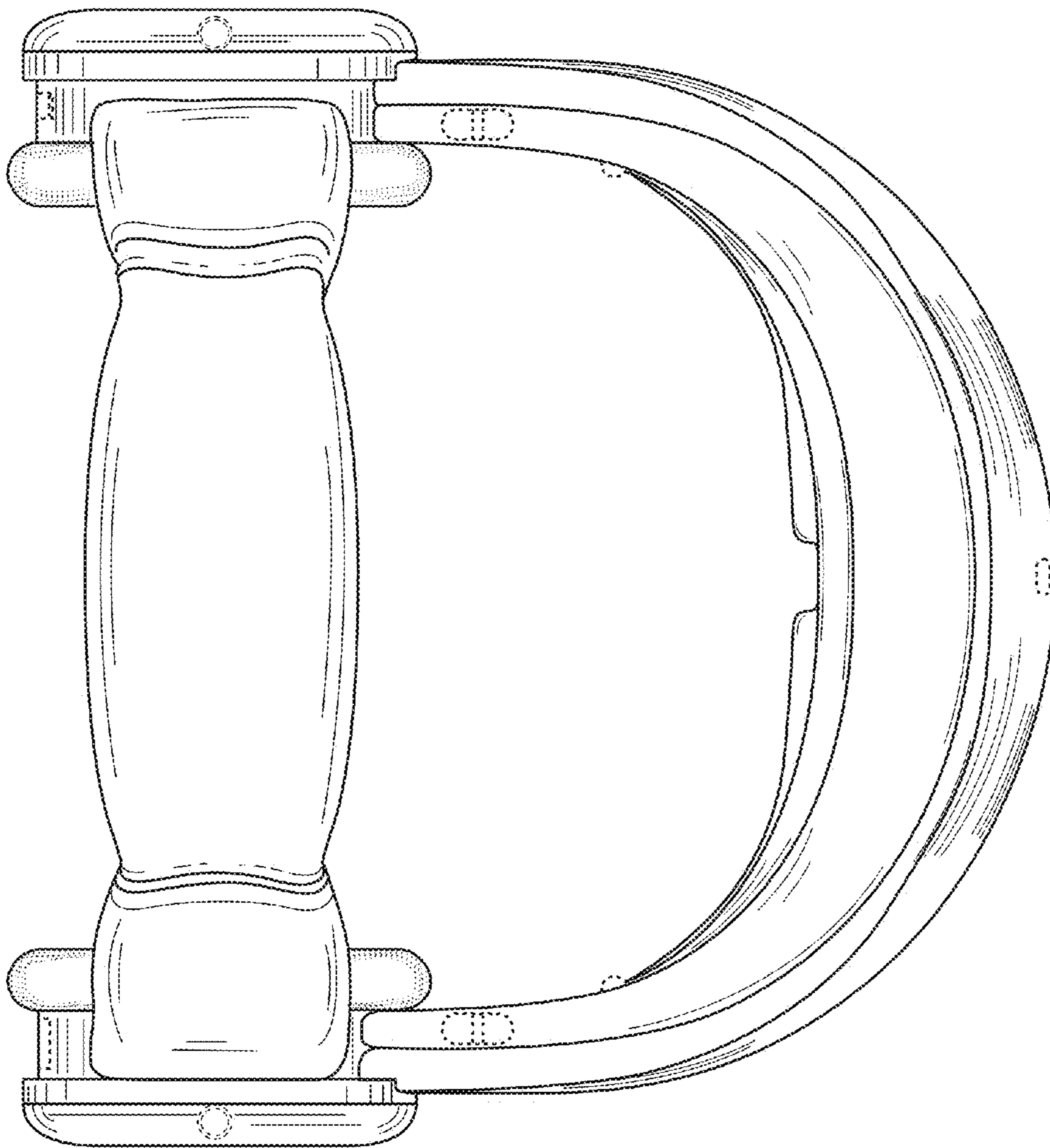

FIG. 4

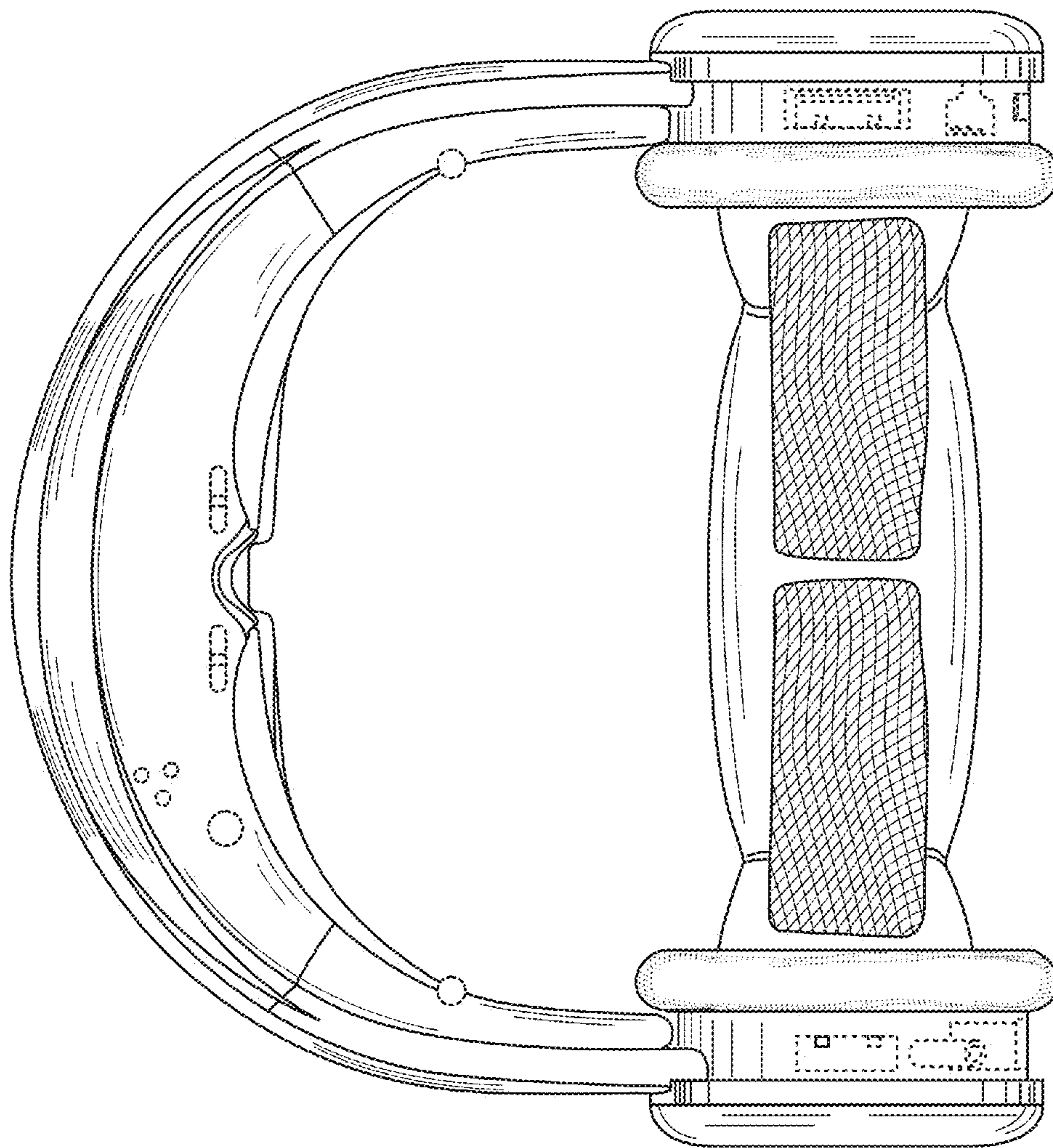

FIG. 5

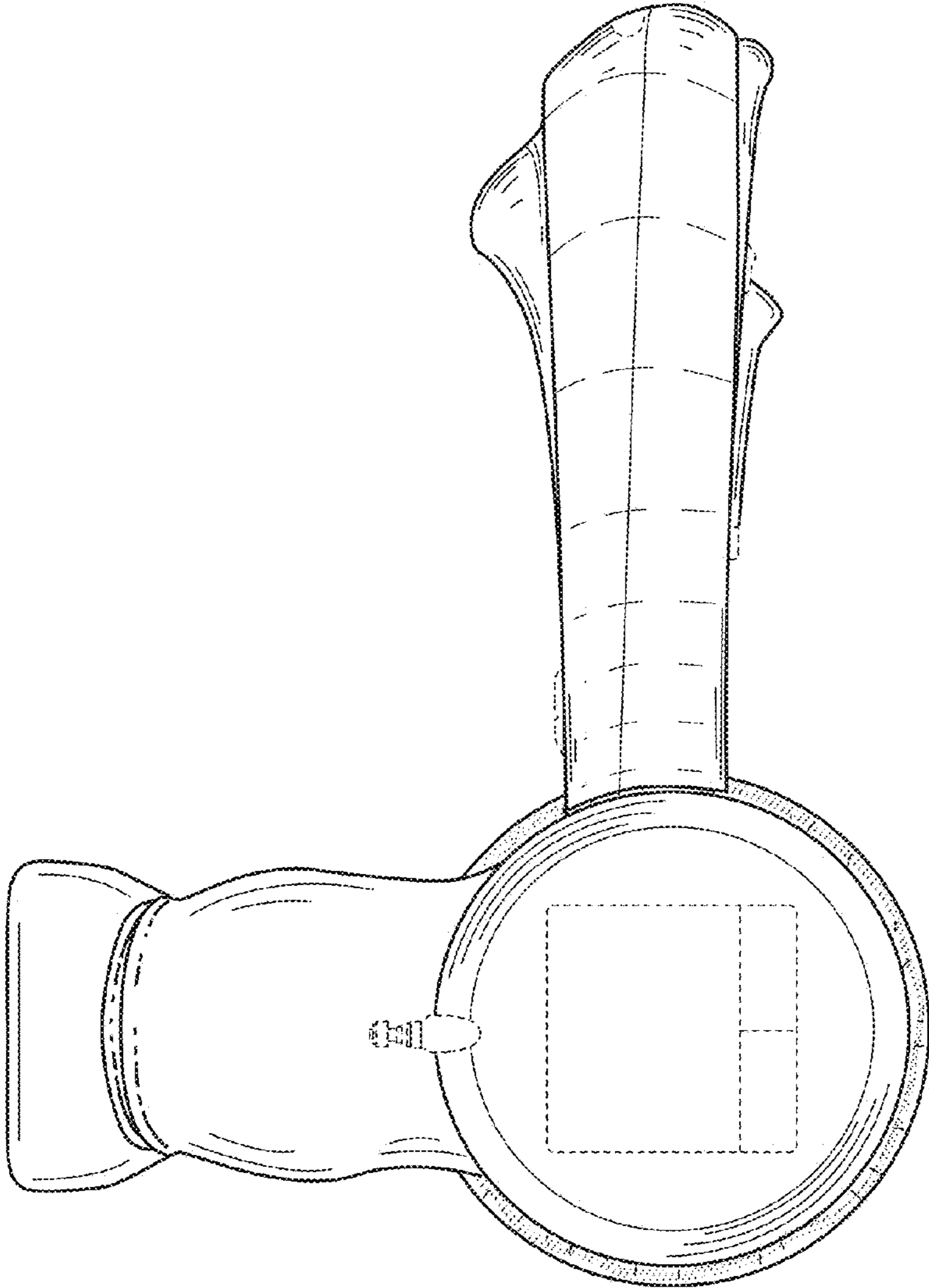

FIG. 6

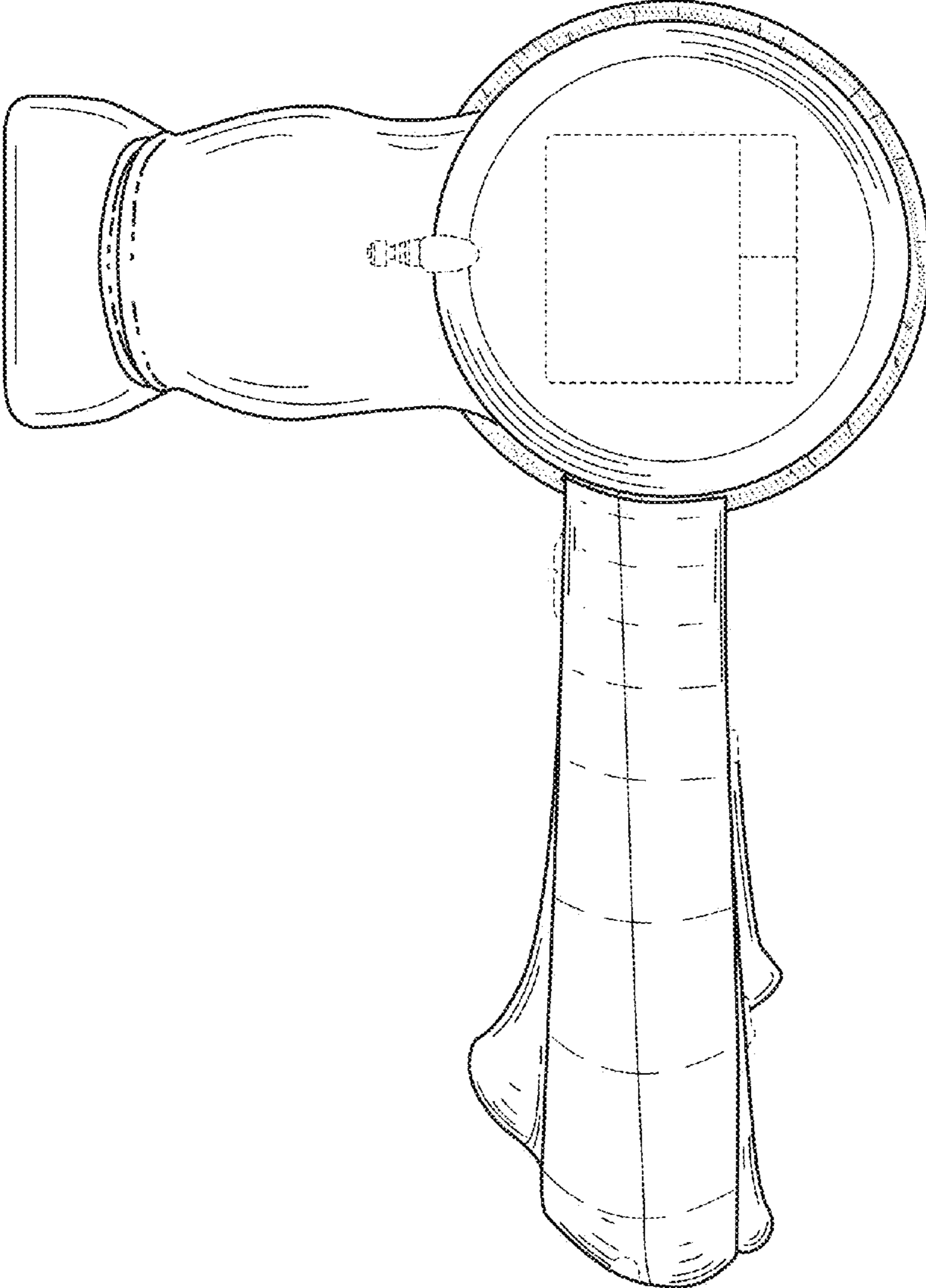

FIG. 7