



US00D704702S

(12) **United States Design Patent**
Akana et al.

(10) **Patent No.:** **US D704,702 S**

(45) **Date of Patent:** **** *May 13, 2014**

(54) **PORTABLE DISPLAY DEVICE WITH COVER**

(71) Applicant: **Apple Inc.**, Cupertino, CA (US)

(72) Inventors: **Jody Akana**, San Francisco, CA (US);
Bartley K. Andre, Palo Alto, CA (US);
Jeremy Bataillou, San Francisco, CA (US);
Daniel J. Coster, San Francisco, CA (US);
Daniele De Iuliis, San Francisco, CA (US);
M. Evans Hankey, San Francisco, CA (US);
Julian Hoenig, San Francisco, CA (US);
Richard P. Howarth, San Francisco, CA (US);
Jonathan P. Ive, San Francisco, CA (US);
Duncan Robert Kerr, San Francisco, CA (US);
Shin Nishibori, Kailua, HI (US);
Matthew Dean Rohrbach, San Francisco, CA (US);
Peter Russell-Clarke, San Francisco, CA (US);
Christopher J. Stringer, Woodside, CA (US);
Eugene Antony Whang, San Francisco, CA (US);
Rico Zörkendörfer, San Francisco, CA (US)

(73) Assignee: **Apple Inc.**, Cupertino, CA (US)

(*) Notice: This patent is subject to a terminal disclaimer.

(**) Term: **14 Years**

(21) Appl. No.: **29/437,767**

(22) Filed: **Nov. 20, 2012**

Related U.S. Application Data

(63) Continuation of application No. 29/386,263, filed on Feb. 25, 2011, now Pat. No. Des. 671,114.

(51) **LOC (10) Cl.** **14-02**

(52) **U.S. Cl.**
USPC **D14/341**

(58) **Field of Classification Search**
USPC D14/341-347, 336, 337, 371, 374, 138,
D14/496, 440; D10/65; 345/901, 104, 133,
345/156, 168, 173; 348/180, 184, 325, 739,
348/373, 376; 385/88; 710/62; 455/575.3,
455/575.1; D19/60; 361/679.27; 178/18.03;
434/317

See application file for complete search history.

(56) **References Cited**

U.S. PATENT DOCUMENTS

2,424,630 A 7/1947 Perez
4,259,568 A * 3/1981 Dynesen 235/1 D

(Continued)

FOREIGN PATENT DOCUMENTS

AU 315078 7/2007
CA 72548 5/1993

(Continued)

OTHER PUBLICATIONS

“A Day in the Life of InfoLink,” Stanford University Libraries, published May 1, 2003.

(Continued)

Primary Examiner — Barbara Fox

(74) *Attorney, Agent, or Firm* — Sterne, Kessler, Goldstein & Fox P.L.L.C.

(57) **CLAIM**

The ornamental design for a portable display device with cover, as shown and described.

DESCRIPTION

FIG. 1 is a left front perspective view of a portable display device with cover showing our new design, with the cover in a folded position;

FIG. 2 is a right rear perspective view thereof;

FIG. 3 is a front view thereof;

FIG. 4 is rear view thereof;

FIG. 5 is a top view thereof;

FIG. 6 is a bottom view thereof;

FIG. 7 is a left side view thereof; and,

FIG. 8 is a right side view thereof.

The broken lines in the Figures show portions of the portable display device with cover which form no part of the claimed design.

The shade lines in the Figures show transparency, and not surface ornamentation.

1 Claim, 6 Drawing Sheets

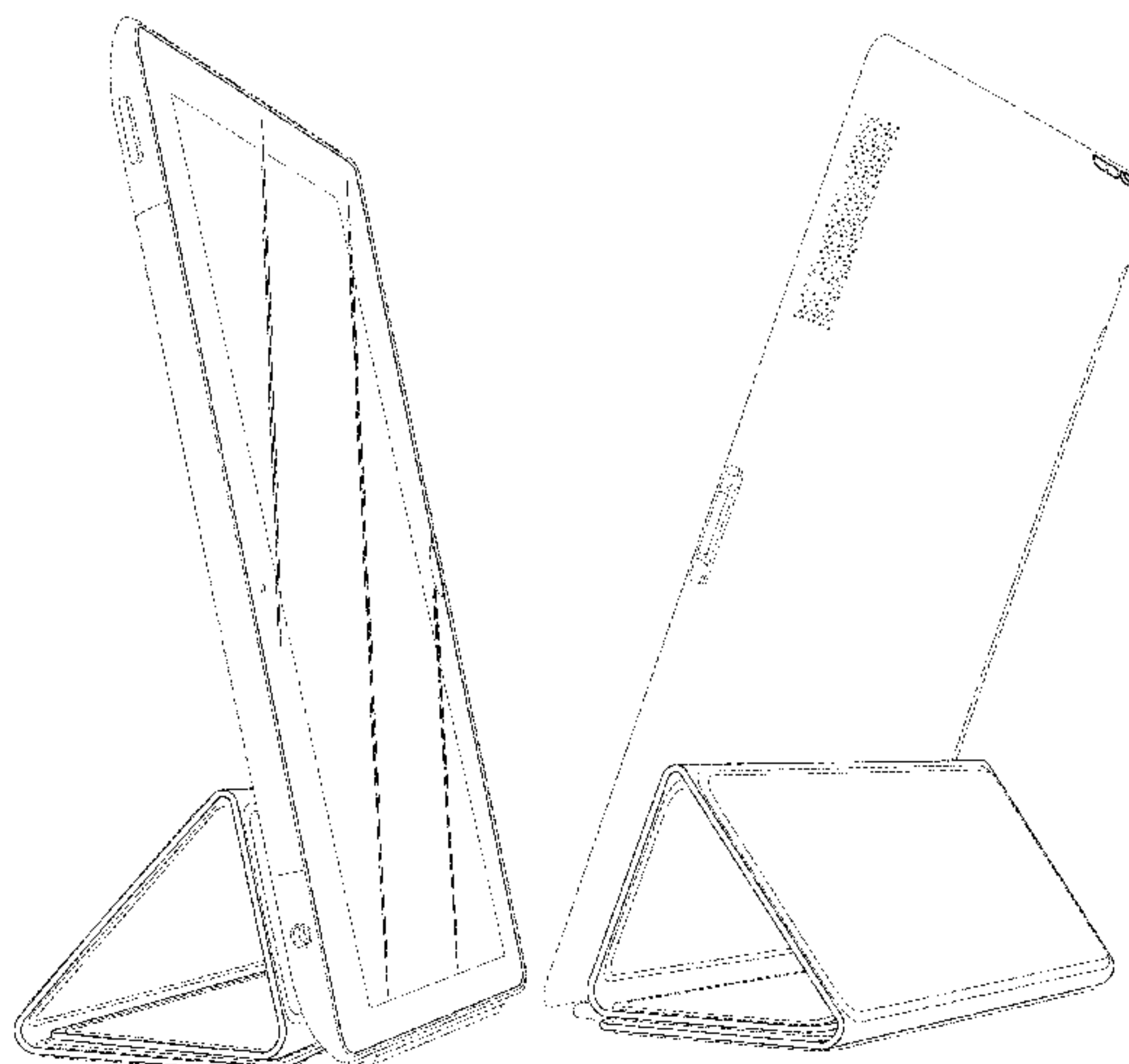

(56)

References Cited

U.S. PATENT DOCUMENTS

D262,151 S	12/1981	Sussman	6,501,967 B1	12/2002	Mäkelä et al.
D265,326 S	7/1982	Sugiyama	D469,413 S	1/2003	To et al.
D268,347 S	3/1983	Marsh	6,509,907 B1	1/2003	Kuwabara
D270,061 S	8/1983	Ackeret	D469,762 S	2/2003	Iwama et al.
D270,062 S	8/1983	Ackeret	D474,163 S	5/2003	Araki
D270,063 S	8/1983	Ackeret	D483,021 S	12/2003	Shih
D270,066 S	8/1983	Ackeret	D483,032 S	12/2003	Bertrand et al.
D271,917 S	12/1983	Magis	D483,359 S	12/2003	Lin et al.
D271,919 S	12/1983	Duffy	D484,471 S	12/2003	Lin et al.
D278,276 S	4/1985	Bakic	6,667,878 B2	12/2003	Ponx
4,545,023 A	10/1985	Mizzi	D485,265 S	1/2004	Sato et al.
D284,084 S	6/1986	Ferrara, Jr.	D486,149 S	2/2004	Kawami et al.
D289,873 S	5/1987	Gemmell et al.	6,690,387 B2	2/2004	Zimmerman et al.
4,703,160 A	10/1987	Narishima et al.	D489,731 S	5/2004	Huang
D306,583 S	3/1990	Krolopp et al.	D490,420 S	5/2004	Solomon et al.
D308,055 S	5/1990	Tedham et al.	D492,684 S	7/2004	Ozolins et al.
D308,760 S	6/1990	King	6,758,335 B2	7/2004	Kajiya
D317,609 S	6/1991	Wei	6,763,942 B1 *	7/2004	Yeh 206/320
D321,215 S	10/1991	Shamis	D496,040 S	9/2004	Jobs et al.
D332,328 S	1/1993	Lombardi, Jr.	D497,364 S	10/2004	Ozolins et al.
D333,574 S	3/1993	Ackeret	6,799,678 B2	10/2004	Sherman
D337,322 S	7/1993	Yang	6,822,635 B2	11/2004	Shahoian et al.
D337,569 S	7/1993	Kando	D500,037 S	12/2004	Ozolins et al.
D340,701 S	10/1993	Takeuchi	D502,179 S	2/2005	Cha et al.
D340,917 S	11/1993	Sakaguchi et al.	D502,944 S	3/2005	Kawami et al.
D345,346 S	3/1994	Alfonso et al.	D504,889 S	5/2005	Andre et al.
D346,589 S	5/1994	Andros	D506,195 S	6/2005	Leveridge et al.
D346,793 S	5/1994	Iino et al.	D514,558 S	2/2006	Nagel et al.
5,345,543 A	9/1994	Capps et al.	D514,568 S	2/2006	Huang et al.
5,347,295 A	9/1994	Agulnick et al.	D528,517 S	9/2006	Izumi
D356,120 S	3/1995	Allen	D532,791 S	11/2006	Kim
5,398,310 A	3/1995	Tchao et al.	7,136,282 B1	11/2006	Rebeske
D361,552 S	8/1995	Iino	D533,347 S	12/2006	Andre et al.
D362,579 S	9/1995	Short	D534,516 S	1/2007	Lheem
5,463,725 A	10/1995	Henckel et al.	D534,517 S	1/2007	Cho et al.
D364,191 S *	11/1995	Allen D21/335	D540,203 S	4/2007	Jeon
5,488,204 A	1/1996	Mead et al.	D543,183 S	5/2007	Cho et al.
5,495,566 A	2/1996	Kwatintz	D543,979 S	6/2007	Lee
D395,639 S	6/1998	Ham et al.	D548,713 S	8/2007	Lee et al.
D396,215 S	7/1998	Inukai	D548,747 S	8/2007	Andre et al.
D396,452 S	7/1998	Naruki	D556,211 S	11/2007	Howard
D408,372 S	4/1999	Ota et al.	D557,259 S	12/2007	Hirsch
D408,794 S	4/1999	Ogasawara	D558,756 S	1/2008	Andre et al.
D409,185 S	5/1999	Kawashima	D558,757 S	1/2008	Andre et al.
D410,440 S	6/1999	Carnell	D558,758 S	1/2008	Andre et al.
D410,769 S	6/1999	Dorizas	D560,072 S	1/2008	Willis
D412,157 S	7/1999	Stevenson	D560,227 S	1/2008	Bennett et al.
D414,926 S	10/1999	Reina	D560,383 S	1/2008	Woods
D418,867 S	1/2000	Platte, III	D564,223 S	3/2008	Messineo
D420,354 S	2/2000	Morales	D565,596 S	4/2008	Kim
D424,535 S	5/2000	Peltola	D567,819 S	4/2008	Devericks et al.
D425,887 S	5/2000	Edwards et al.	D568,605 S *	5/2008	Harris et al. D3/218
6,061,063 A	5/2000	Wagner et al.	D572,023 S	7/2008	Park
6,067,068 A	5/2000	Hussain	D572,694 S	7/2008	Park
D433,808 S	11/2000	Moorhouse, Sr.	D573,143 S	7/2008	Park et al.
D438,201 S	2/2001	Ogawa et al.	7,398,868 B2	7/2008	Morszeck
D444,465 S	7/2001	Do	D575,760 S	8/2008	Kim et al.
D448,031 S	9/2001	Goetz	D577,703 S	9/2008	Lee et al.
D448,764 S	10/2001	Marsalka et al.	D580,387 S	11/2008	Andre et al.
6,310,610 B1	10/2001	Beaton et al.	D580,431 S	11/2008	Morita
D451,505 S	12/2001	Iseki et al.	D581,150 S	11/2008	Chamberlain
D452,687 S	1/2002	Yeh	D581,922 S	12/2008	Andre et al.
6,337,698 B1	1/2002	Keely, Jr. et al.	D582,405 S *	12/2008	Andre et al. D3/299
D453,333 S	2/2002	Chen	D582,661 S	12/2008	Katsof
D454,348 S	3/2002	Yeh	D583,346 S	12/2008	Jung et al.
D455,433 S	4/2002	Alviar et al.	D583,373 S	12/2008	Chen
D456,023 S	4/2002	Andre et al.	D584,711 S	1/2009	Kim et al.
D456,805 S	5/2002	Ono et al.	D584,738 S	1/2009	Kim et al.
D457,530 S	5/2002	Amron	D586,800 S	2/2009	Andre et al.
D458,252 S	6/2002	Palm et al.	D588,354 S	3/2009	Chamberlain
D461,175 S	8/2002	Yokota	D592,211 S	5/2009	Ichise et al.
D461,802 S	8/2002	Tu	D592,212 S	5/2009	Hamada et al.
D466,096 S	11/2002	Takada	D593,059 S	5/2009	Kim et al.
D466,501 S	12/2002	Hirota	D594,863 S	6/2009	Ichise et al.
D467,890 S	12/2002	Lai et al.	D597,067 S	7/2009	Oh et al.
			D598,016 S	8/2009	Han et al.
			D599,342 S	9/2009	Andre et al.
			D599,761 S *	9/2009	Birsel et al. D14/138 R
			D600,241 S	9/2009	Andre et al.

(56)

References Cited

U.S. PATENT DOCUMENTS

D600,455 S * 9/2009 Nell D6/308
 D600,690 S 9/2009 Miyaji
 D601,353 S 10/2009 Sadler et al.
 D601,558 S 10/2009 Andre et al.
 D602,014 S 10/2009 Andre et al.
 D602,015 S 10/2009 Andre et al.
 D602,016 S 10/2009 Andre et al.
 D602,017 S 10/2009 Andre et al.
 D602,486 S 10/2009 Andre et al.
 D602,488 S 10/2009 Jiang et al.
 D603,398 S * 11/2009 Watson et al. D14/345
 D603,906 S 11/2009 Miller et al.
 D604,290 S 11/2009 Andre et al.
 D604,291 S 11/2009 Andre et al.
 D604,292 S 11/2009 Andre et al.
 D604,293 S 11/2009 Andre et al.
 D604,297 S 11/2009 Andre et al.
 D604,733 S 11/2009 Andre et al.
 D606,129 S 12/2009 Ben-Moshe
 D606,988 S 12/2009 Andre et al.
 D606,989 S 12/2009 Andre et al.
 D606,991 S 12/2009 Liu et al.
 D606,992 S 12/2009 Liu et al.
 D607,255 S 1/2010 Sunseri
 D607,428 S 1/2010 Kim et al.
 D609,705 S 2/2010 Andre et al.
 D609,912 S 2/2010 Kyono et al.
 7,658,675 B2 2/2010 Hotta
 D611,045 S 3/2010 Andre et al.
 D611,469 S 3/2010 Andre et al.
 7,688,574 B2 3/2010 Zadesky et al.
 D613,735 S 4/2010 Andre et al.
 D613,736 S 4/2010 Andre et al.
 D615,083 S 5/2010 Andre et al.
 D616,436 S 5/2010 Busri
 D617,793 S 6/2010 Chiang et al.
 D619,555 S 7/2010 Yang et al.
 D620,004 S 7/2010 Andre et al.
 D621,825 S 8/2010 Andre et al.
 D622,514 S 8/2010 Park et al.
 D622,718 S 8/2010 Andre et al.
 D622,719 S 8/2010 Andre et al.
 D622,720 S 8/2010 Andre et al.
 D623,184 S 9/2010 Green et al.
 D624,070 S 9/2010 Lee et al.
 D624,071 S 9/2010 Dan
 D624,072 S 9/2010 Andre et al.
 D624,074 S 9/2010 Green et al.
 D624,304 S 9/2010 Danze et al.
 D624,536 S 9/2010 Andre et al.
 D624,914 S 10/2010 Wang
 D625,307 S 10/2010 Cheng
 D625,928 S 10/2010 Lee et al.
 D627,343 S 11/2010 Andre et al.
 D627,777 S 11/2010 Akana et al.
 D627,778 S 11/2010 Akana et al.
 D629,195 S 12/2010 Jusic
 D629,799 S 12/2010 Andre et al.
 D630,207 S 1/2011 Seong
 D630,630 S 1/2011 Andre et al.
 D631,474 S 1/2011 Green et al.
 D632,688 S 2/2011 Seong
 D633,090 S 2/2011 Andre et al.
 D633,091 S 2/2011 Andre et al.
 D633,092 S 2/2011 Andre et al.
 D633,490 S 3/2011 Kim et al.
 D633,908 S 3/2011 Akana et al.
 D634,319 S 3/2011 Andre et al.
 D634,742 S 3/2011 Andre et al.
 D635,540 S 4/2011 Kim et al.
 D635,952 S 4/2011 Park et al.
 D636,390 S 4/2011 Andre et al.
 D636,392 S 4/2011 Akana et al.
 D636,769 S 4/2011 Wood et al.
 D636,770 S 4/2011 Li

D637,596 S 5/2011 Akana et al.
 D637,814 S * 5/2011 Akana et al. D3/303
 D638,815 S 5/2011 Lee et al.
 D638,835 S 5/2011 Akana et al.
 D639,296 S * 6/2011 Tseng et al. D14/345
 D639,816 S 6/2011 Bau
 D641,018 S 7/2011 Lee et al.
 D641,348 S 7/2011 Kim et al.
 D642,563 S 8/2011 Akana et al.
 D644,218 S 8/2011 Akana et al.
 D645,017 S 9/2011 Kim et al.
 D645,435 S 9/2011 Kim et al.
 D645,835 S 9/2011 Lee et al.
 D646,249 S 10/2011 Kim et al.
 D646,252 S 10/2011 Kim et al.
 8,035,963 B2 10/2011 Ladouceur et al.
 D648,693 S 11/2011 Kim et al.
 D658,186 S 4/2012 Akana et al.
 D662,100 S * 6/2012 Van Den Nieuwenhuizen
 et al. D14/440
 8,245,843 B1 * 8/2012 Wu 206/320
 D670,692 S 11/2012 Akana et al.
 D671,114 S * 11/2012 Akana et al. D14/341
 8,312,991 B2 * 11/2012 Diebel et al. 206/45.24
 D672,353 S * 12/2012 Liu D14/440
 D672,781 S * 12/2012 Lu D14/440
 D674,800 S * 1/2013 Kim D14/440
 D676,449 S * 2/2013 Probst et al. D14/440
 D677,658 S 3/2013 Akana et al.
 D677,668 S * 3/2013 Phillips et al. D14/440
 D678,260 S * 3/2013 Bau D14/250
 D678,291 S * 3/2013 Phillips et al. D14/440
 D678,292 S * 3/2013 Phillips et al. D14/440
 D679,279 S * 4/2013 Yang et al. D14/440
 D681,033 S * 4/2013 Chen et al. D14/345
 D682,279 S * 5/2013 Fuchs D14/440
 D682,837 S * 5/2013 Lee et al. D14/440
 D682,839 S * 5/2013 Sampson et al. D14/447
 D685,799 S * 7/2013 Canizares et al. D14/440
 D685,800 S * 7/2013 Canizares et al. D14/440
 D685,801 S * 7/2013 Canizares et al. D14/440
 D685,802 S * 7/2013 Canizares et al. D14/440
 2003/0125079 A1 7/2003 Park et al.
 2003/0125094 A1 7/2003 Hyun et al.
 2003/0125959 A1 7/2003 Palmquist et al.
 2003/0150756 A1 * 8/2003 Kajiya 206/320
 2003/0184525 A1 10/2003 Tsai
 2003/0206202 A1 11/2003 Moriya
 2004/0021676 A1 2/2004 Chen et al.
 2004/0041504 A1 3/2004 Ozolins et al.
 2005/0156902 A1 7/2005 McPherson et al.
 2009/0107858 A1 4/2009 Huang
 2009/0159763 A1 * 6/2009 Kim 248/174
 2010/0232103 A1 9/2010 Chen
 2010/0294683 A1 11/2010 Mish et al.
 2011/0164365 A1 7/2011 McClure et al.
 2011/0227463 A1 9/2011 Hou et al.
 2011/0267757 A1 * 11/2011 Probst et al. 361/679.09
 2012/0140396 A1 * 6/2012 Zelif et al. 361/679.09
 2012/0194448 A1 * 8/2012 Rothkopf 345/173
 2012/0211613 A1 * 8/2012 Yang et al. 248/174

FOREIGN PATENT DOCUMENTS

CA 89155 3/2000
 CA 101263 1/2004
 CN 3455506 6/2005
 CN 1695105 A 11/2005
 CN 3675965 8/2007
 CN 300724841 12/2007
 CN 300759405 3/2008
 DE 40104198-0001 9/2001
 DE 40301867-0001 10/2003
 DE 40705936-0001 5/2008
 EM 000048061-0001 8/2003
 EM 00048061-0001 8/2003
 EM 000046198-0001 11/2003
 EM 000181607-0001 8/2004
 EM 000328265-0001 6/2005

(56)

References Cited

FOREIGN PATENT DOCUMENTS		
EM	000401898-0003	11/2005
EM	00066789-0001	3/2007
EM	000748314-0001	10/2007
EM	000891809-0003	4/2008
EP	0 701 220 B1	7/2001
ES	10147763	3/2001
FI	4897	7/1980
FR	990052-001	5/1999
FR	985598-001	10/2001
FR	985598-002	10/2001
FR	985598-003	10/2001
FR	985598-004	10/2001
GB	1042780	12/1986
GB	1058720	10/1988
GB	1058721	10/1988
GB	2030050	7/1993
GB	2033245	8/1993
GB	2101448	10/2000
GB	2103809	2/2001
GB	3009998	1/2003
GB	3010002	1/2003
GB	3014024	10/2003
GB	3022447	10/2005
JP	61-69284	4/1986
JP	4-370868	12/1992
JP	886431	12/1993
JP	887388	12/1993
JP	6-102341	4/1994
JP	921403	3/1995
JP	000921403	3/1995
JP	949744	3/1996
JP	953136	5/1996
JP	9-325180	12/1997
JP	1009317	5/1998
JP	11-112918	4/1999
JP	11-126149	5/1999
JP	11-289169	10/1999
JP	1056385	12/1999
JP	2000-163031	6/2000
JP	2000-322495	11/2000
JP	2001-22471	1/2001
JP	2001-22704	1/2001
JP	D1098145	1/2001
JP	D1104685	3/2001
JP	D1124750	10/2001
JP	D1133939	2/2002
JP	D1142127	5/2002
JP	D1143615	6/2002
JP	D1145748	7/2002
JP	2002-254614	9/2002
JP	D1155168	10/2002
JP	D1155176	10/2002
JP	D1159881	12/2002
JP	D1178470	7/2003
JP	D1188041	10/2003
JP	2003-330613	11/2003
JP	D1194485	1/2004
JP	D1204221	5/2004
JP	2004-290256	10/2004
JP	D1235888	4/2005
JP	D1241383	6/2005
JP	D1241638	6/2005
JP	D1247215	8/2005
JP	D1250487	9/2005
JP	D1263649	2/2006
JP	D1280315	9/2006
JP	D1285057	10/2006
JP	D1295003	2/2007
JP	D1302929	6/2007
JP	D1325539	3/2008
KR	30-0037851	8/1982
KR	30-0109896	11/1990
KR	30-0110034	11/1990
KR	30-0213519	4/1998
KR	30-0222985-1	2/1999

KR	30-0237641	6/1999
KR	30-0241312	7/1999
KR	30-0243584	8/1999
KR	30-0288858	1/2002
KR	30-0290725	1/2002
KR	30-0291915	2/2002
KR	30-0294002	3/2002
KR	30-0296928	5/2002
KR	30-0297741	5/2002
KR	30-0304213	8/2002
KR	30-0307008	9/2002
KR	30-0307235	9/2002
KR	30-0307307	9/2002
KR	30-0309692	10/2002
KR	30-0312151	11/2002
KR	30-0312152	11/2002
KR	30-0330831	8/2003
KR	30-0332851	9/2003
KR	30-0336260	10/2003
KR	30-0338781	11/2003
KR	2003-0088374	11/2003
KR	30-0338886	12/2003
KR	30-0326632-2	1/2004
KR	30-0398307	11/2005
KR	30-0394921-1	12/2005
KR	30-0418422-1	7/2006
KR	30-0418547	7/2006
KR	30-0422221	8/2006
KR	30-0422222	8/2006
KR	30-0424148	9/2006
KR	30-0452432	6/2007
KR	30-0452985	8/2007
KR	30-0452985-2	8/2007
SE	55044	10/1993
SE	2001/0343	9/2002
TW	584453	4/2004
WO	WO 00/74240	7/2000
WO	WO 00/74240 A1	12/2000
WO	WO 01/88679	11/2001
WO	WO 2004/023272 A2	3/2004

OTHER PUBLICATIONS

“The Oracle: The Personal Computer of the Year 2000,” Stanford University Libraries.

“The Organizer: The Personal Computer of the Year 2000,” Stanford University Libraries.

01net, “Fiche Technique Philips SPH8008,” (<http://www.01net.com/fiche-produit/fiche-technique-7075/cadres-numeriques-philips-sph8008/>), retrieved Nov. 21, 2011, 7 pages.

01net, “Fiche Technique Philips SPH8008,” (<http://www.01net.com/images/produit/full/philips-sph8008-1.jpg>), retrieved Nov. 21, 2011, 1 page.

01net, “Fiche Technique Philips SPH8008,” (<http://www.01net.com/images/produit/full/philips-sph8008-2.jpg>), retrieved Nov. 21, 2011, 1 page.

01net, “Fiche Technique Philips SPH8008,” (<http://www.01net.com/images/produit/full/philips-sph8008-3.jpg>), retrieved Nov. 21, 2011, 1 page.

01net, “Fiche Technique Philips SPH8008,” (<http://www.01net.com/images/produit/full/philips-sph8008-4.jpg>), retrieved Nov. 21, 2011, 1 page.

Akihabara News Team, “Electricpig Gets Hands On Hannspad Android Tablet,” (<http://en.akihabaraneews.com/73543/tablet-pda/electricpig-gets-hands-on-hannspad-android-tablet/>), published Nov. 22, 2010, 1 page.

Aliexpress.com, “WACOM PL-500 15" LCD Tablet Mint,” (<http://www.aliexpress.com/product-fm/430172068-WACOM-PL-500-15-LCD-Tablet-Mint-Worldwide-Free-Shipping-wholesalers.html>), accessed Nov. 14, 2011, 3 pages.

Allan, “Hannspad Android tablet: photos and video,” Electricpig.co.uk, (<http://www.electricpig.co.uk/2010/11/18/hannspad-android-tablet-photos-and-video/>), published Nov. 18, 2010, 6 pages.

Amazon, “Developing Tablet PC Applications—(Charles River Media Programming),” (<http://www.amazon.co.uk/Developing-Tablet-Applications-Charles-Programming/dp/1584502525>), retrieved Jan. 10, 2012, 4 pages.

(56)

References Cited

OTHER PUBLICATIONS

Amazon, "STL Deutschland Digitaler Bilderrahmen DF-711 B," (<http://www.amazon.de/STL-Deutschland-Digitaler-Biderrahmen-DF-711/dp/B002D5K6YK>), retrieved Nov. 21, 2011, 4 pages.

Amazon.com, "Digitalway MPIO FL100 128 MB MP3 Player" (<http://www.amazon.com/Digitalway-MPIO-FL100-128-Player/dp/B00008V6NI>), accessed Nov. 17, 2011, 7 pages.

Amazon.com, "Whirlpool Gold : GH7208XRS 2.0 cu. ft. Velos Speedcook Over the Range Microwave Oven," (<http://www.amazon.com/Whirlpool-Gold-GH7208XRS-Speedcook-Microwave/dp/B000ZIPHM8>), accessed May 23, 2012, 5 pages.

AndroidTabletFanatic.com "16 Old-Skool Tablets Rocking it Before the iPad," (<http://www.androidtabletfanatic.com/android-tablet-news/16-old-skool-tablets-rocking-it-before-the-ipad/>), published May 16, 2011, 10 pages.

Apple Computer, Inc., "Apple Cinema Display," 1999, 21 pages.

Apple Computer, Inc., "Setting Up Your Studio Display 15-Inch flat panel monitor," 1999, 37 pages.

Apple Inc., "iPod touch (2nd generation)," (<http://support.apple.com/kb/ht1353>), retrieved Nov. 21, 2011, 1 page.

Arrington, "CrunchPad: The Launch Prototype," TechCrunch.com, (<http://techcrunch.com/2009/06/03/crunchpad-the-launch-prototype/>), published Jun. 3, 2009, 5 pages.

Arrington, We Want A Dead Simple Web Tablet for \$200. Help Us Build It., TechCrunch.com, (<http://techcrunch.com/2008/07/21/we-want-a-dead-simple-web-tablet-help-us-build-it/>), published Jul. 21, 2008, 3 pages.

Arrington, M., TechCrunch.com, "TechCrunch Tablet Update: Prototype B," (<http://techcrunch.com/2009/01/19/techcrunch-tablet-update-prototype-b/>), published Jan. 19, 2009, 25 pages.

Association for Computing Machinery, The Open Video Project, "ACM CHI 1995—The Tablet Newspaper: A vision for the Future," (<http://www.open-video.org/details.php?videoid=8315&surrogate=storyboard>), 1994, 3 pages.

ASUS Computer Inc., "ASUS Tablet Computers—Providing Choice through Innovation at CES 2011," (<http://milandesignweek2011.asus.com/archives/ces-2011/asus-tablet-computers-providing-choice-through-innovation-at-ces-2011/>), published Jan. 4, 2011, 4 pages.

Aumente, J., American Journalism Review, "Panel Vision," (<http://www.ajr.org/Article.asp?id=1257>), published Oct. 1994, 7 pages.

Axiotron, "Axiotron at Macworld Expo 2009," (<http://www.axiotron.com/index.php?id=events>), retrieved Jun. 1, 2011, 4 pages.

Ballmer, S., Spiegel Online, "Bill Gates, Tablet PC: "Mira" war 2002 die große Vision des Microsoft-Gründers—kam aber wohl zu früh für den Markt," product announced 2002, 4 pages.

Ballmer, S., Spiegel Online, "Tablet PC," (<http://www.spiegel.de/netzwelt/gadgets/0,1518,670427,00.html>), published Jan. 6, 2010, 6 pages.

BeBook Neo e-reader launches with WiFi and WACOM capabilities, Engadget.com, (<http://www.engadget.com/2010/01/22/bebook-neo-e-reader-launches-with-wifi-and-wacom-capabilities/>) accessed Apr. 26, 2010, 2 pages.

Blandford, "Nokia N92 Preview," (http://www.allaboutsymbian.com/features/item/Nokia_N92_Preview.php), published Nov. 23, 2005, 10 pages.

Blickenstorfer, "Tablet PCs: HP Compaq Tablet PC TC1000," (http://pencomputing.com/frames/tpc_compaq.html), published Dec. 2002, 3 pages.

Blickenstorfer, C., PenComputing Magazine, "Tablet PCs: Motion Computing M1200," (http://pencomputing.com/frames/tpc_motion1200.html), published Dec. 2002, 3 pages.

Blickenstorfer, C., PenComputing Magazine, "Tablet PCs: ViewSonic V1100," (http://pencomputing.com/frames/tpc_viewsonic.html), published Dec. 2002, 3 pages.

Block, "Olympus @ CES Hands-on with the m:robe MR-500i and MR-100," Engadget.com, (<http://www.engadget.com/2005/01/10/olympus-ces-hands-on-with-the-m-robe-mr-500i-and-mr-100>), published Jan. 10, 2005, 3 pages.

Block, "Philips PET830 and PET1030 media players," Engadget, (<http://www.engadget.com/2006/11/29/philips-pet830-and-pet1030-media-players/>), published Nov. 29, 2006, 2 pages.

Boggs, "Electrovaya Scribbler SC4000 Review," Tablet PC Review, (<http://www.tabletpcreview.com/default.asp?newsID=1130>), published Apr. 15, 2008, 6 pages.

Bookeen, "New Cybook Opus," (<http://www.bookeen.com/ebook/ebook-reading-deviceaSPX>), retrieved Apr. 26, 2010, 2 pages.

Bower, "iPod Tablet [Mockup]," MacPredictions, (<http://www.macpredictions.com/2009/04/ipod-tablet-mockup.html>), published Apr. 18, 2009, 8 pages.

Bray, "LG Optimus Pad review: first look," PCPro.com, (<http://www.pcpro.co.uk/blogs/2011/02/14/lg-optimus-pad-review-first-look/>), published Feb. 14, 2011, 3 pages.

Cashmore, P., Mashable, "Apple Tablet: Ultimate Gallery of Concept Designs and Prototypes," (<http://mashable.com/2009/08/07/apple-tablet-gallery/>), published Aug. 7, 2009, 28 pages.

Cell Phones.About.com, "More pictures of the LG KG800," (http://cellphones.about.com/library/bl-pi-lg_kg800.htm), accessed Feb. 13, 2012, 1 page.

CES: Plastic Logic's Que E-Reader Revealed, PCWorld.com, (http://www.pcworld.com/article/186224/ces_plastic_logics_que_ereader_revealed.html), accessed Apr. 26, 2010, 1 page.

Cesweb, "MPIO," (http://www.cesweb.org/shared_files/innovations/innovations_2003/1616/mainphoto1616.jpg), retrieved Feb. 24, 2012, 1 page.

Chi-atheneum, "Good Design 2003, An International Industrial and Graphic Design Competition," (<http://www.chi-atheneum.org/gdesign/winners03.htm>), retrieved Sep. 23, 2011, 7 pages.

Chip Online, "VIA: Zwitter-PC für Schöngesteier," (http://www.chip.de/ii/202812385_78f68afa8c.jpg), published May 8, 2002, 1 page.

Chip Online, "VIA: Zwitter-PC für Schöngesteier," (http://www.chip.de/news/VIA-Zwitter-PC-fuer-Schoengeister_34204096.html), Published May 8, 2002, 2 pages.

Chubb, D., Product-reviews.net, "Amtek's iTablet T221: new to the tablet and UMPC scene," (<http://www.product-reviews.net/2008/01/11/amteks-itablt-t221-new-to-the-tablet-and-umpc-scene/>), published Jan. 11, 2008, 4 pages.

Clarke, "Newspad by Authur C. Clarke from 2001: A Space Odyssey," (<http://www.technovelgy.com/ct/content.asp?Bnum=529>), published 1968, 3 pages.

Cnet, "HP Compaq Tablet PC TC1000 Review," (http://reviews.cnet.com/tablet-pcs/hp-compaq-tablet-pc/4505-3126_7-20627295.htm), published Nov. 6, 2002, 5 pages.

Cnet, "Sony Clie," (<http://reviews.cnet.com/sc/30733801-2-440-overview-1.gif>), retrieved Feb. 26, 2012, 1 page.

Coldewey, D., CrunchGear.com, "TechCrunch Tablet makes an early debut," (<http://www.crunchgear.com/2009/04/09/crunchtablet-hits-the-net-a-little-early/>), published Apr. 9, 2009, 26 pages.

Computer Museum, "Toshiba Dynapad T100X (1992)," (<http://www.computermuseum.li/Testpage/Toshiba-Dynapad-1992.htm>), product announced Nov. 1992, 1 page.

ComputerWeekly.com, "Why the Blackberry Playbook is for enterprise users," (<http://www.computerweekly.com/news/1280097215/Why-the-Blackberry-Playbook-is-for-enterprise-users>), published Sep. 28, 2010, 1 page.

Computex.biz, "Tatung Tablet PC," (http://www.computex.biz/tatung/Default.aspx?pagetype=ProductDetail&pdt_id=36&cid=3...), accessed Nov. 4, 2011, 3 pages.

Computing History, "GRidPad 1910," (<http://www.computinghistory.org.uk/det/6565/GRidPad-1910>), retrieved Sep. 12, 2011, 2 pages.

Davies, C., Slashgear.com, "Are Dell planning a keyboard-less UMPC?," (<http://www.slashgear.com/are-dell-planning-a-keyboard-less-umpc-096130/>), published Jul. 9, 2007, 15 pages.

De Herrera, C., tabletpctalk, "Tatung Tablet PC Picture," (<http://www.tabletpctalk.com/pictures/tatung.shtml>), 2003, 3 pages.

Dg2000, Flickr, "Sony CLIE PEG-TH55/E1," (<http://www.flickr.com/photos/derekwilkinson/1323901259/>), photo taken Sep. 4, 2007, 2 pages.

Digibarn Computer Museum, "Image of the GO tablet," (<http://www.digibarn.com/collections/systems/go/DSC02917.JPG>), retrieved Feb. 24, 2012, 1 page.

(56)

References Cited

OTHER PUBLICATIONS

Digibarn Computer Museum, "Image of the GO tablet," (<http://www.digibarn.com/collections/systems/go/DSC02942.JPG>), retrieved Feb. 24, 2012, 1 page.

Digibarn Computer Museum, "PenPoint tablet pen computer by GO Corporation," (<http://www.digibarn.com/collections/systems/go/index.html>), retrieved Jul. 18, 2011, 6 pages.

DigiBarn Systems, "GRiDpad Pen Computer," (<http://www.digibarn.com/collections/systems/gridpad/index.html>), retrieved Sep. 23, 2011, 2 pages.

Dunn, J., DigitalHomeThoughts.com, "Ultra-Portable Concept PC Shown at WinHEC 2005," (<http://www.digitalhomethoughts.com/news/show/27459/ultra-portable-concept-pc-shown-at-winhec-2005.html>), published Apr. 26, 2005, 4 pages.

Edible Apple, "The first Apple Tablet . . . from 1979," (<http://www.edibleapple.com/the-first-apple-tablet-from-1979/>), published Nov. 23, 2009, 8 pages.

Electricpig, "IFA 2010: Toshiba booth tour—Folio 100, Jacob Jensen and a few extra treats," Electricpig.co.uk, (<http://www.electricpig.co.uk/2010/09/03/ifa-2010-toshiba-booth-tour-folio-100-jacob-jensen-and-a-few-extra-treats/ifa-2010-toshiba-booth-tour-8/>), published Sep. 3, 2010, 1 page.

Electrovaya, "Electrovaya Launches Scribbler® SC4000 Series Tablet PC," published Jan. 9, 2008, 2 pages.

EngineerBoy, CleverDonkey, "2001: A Space Odyssey and the iPad (or is it tamPod?)," (<http://www.cleverdonkey.com/1499-2001a-space-odyssey-and-the-ipad-or-is-it-tampod/>), published Feb. 2, 2010, 5 pages.

Falcone, J., Cnet, "Digitalway MPIO-FL100 (128 MB)," (http://reviews.cnet.com/mp3-players/digitalway-mpio-fl100-128/4505-6490_7-20763548.html), published Apr. 18, 2003, 8 pages.

Fidler, "Mcdiamorphosis: Understanding New Media," pp. 220, 222-225, and 236-242, Pine Forge Press, Thousand Oaks, CA (1997).

Fidler, "Predicting e-readers in 1981: A look back at the future," Associated Press Managing Editors, (<http://www.snd.org/2010/01/predicting-e-readers-in-1981-a-look-back-at-the-future/>) published Jan. 14, 2010, 5 pages.

Flatley, "BoEye MID700 unveiled with Android OS, vaguely familiar form factor," Engadget.com, (http://engadget.com/2009/11/11/boeye-mid700-unveiled-with-android-os-vaguely-familiar-form-fac/?icid=eng_Dubai_art), published Nov. 11, 2009, 2 pages.

Focus Online, "Rollei DF8 DVB-T," (http://www.focus.de/digital/foto/rollei-df8-dvb-t-fernsehen-im-bilderrahmen__did_27152.html), published Feb. 18, 2010, 3 pages.

Foto-Branche.de, "Kodak EasyShare S730: Digitaler Bilderrahmen mit integriertem Akku," (<http://www.foto-branche.de/news/singleview/browse/2/article/kodak-easyshare-s730-digitaler-bilderrahmen-mit-integriertem-akku/2.html>), published Jul. 13, 2009, 2 pages.

Fotofabrikas, "AgfaPhoto AF 5087 MS 8," (http://www.fotofabrikas.lt/data/images/catalog_pics/n_preview/Skaitmeniniai%20remeliai%20AgfaPhoto%20AF%205087%20MS%208%20skaitmeninis%20r%20melis_01.jpg), retrieved Nov. 22, 2011, 1 page.

Fotofabrikas, "AgfaPhoto AF 5087 MS 8," (<http://www.fotofabrikas.lt/en/items/Digital-Frames/Digital-photo-frames/2636ee42-AgfaPhoto-AF-5087-MS-8.html>), retrieved Nov. 21, 2011, 5 pages.

Fried, "Live-blogging Steve Ballmer," CNET, (http://www.cnet.com/8301-31045_1-10426723-269.html?tag=mncol%3btxt), published Jan. 6, 2010, 6 pages.

Funamizu, M., Petitinvention, "(iPod Touch + iMac + Macbook Air) / 3," (<http://petitinvention.wordpress.com/2008/05/03/ipod-touch-imac-macbook-air-3/>), published May 3, 2008, 4 pages.

GadgetFolder, "iRex Digital Reader 800 with 8-inch touchscreen and wireless," (<http://www.gadgetfolder.com/irex-digital-reader-800-with-8-inch-touchscreen-and-wireless.html>), published Aug. 9, 2009, 5 pages.

Ganapati, "Hands On With the JooJoo, Formerly Known as CrunchPad," (<http://www.wired.com/gadgetlab/2009/12/hands-on-joo-joo-crunchpad/all/1>), published Dec. 7, 2009, 3 pages.

Gilder, "Digital Darkhorse—Newspapers," Forbes ASAP, published Oct. 25, 1993, pp. 138-139.

Gizmodo, "Kurztest: JooJoo (Crunchpad)—riesiges Internet-Tablet," (<http://www.gizmodo.de/2009/12/09/kurztest-joojoo-crunchpad-riesiges-internet-tablet.html>), retrieved Sep. 26, 2011, 13 pages.

Gollwitzer, M., et al., Chip Online, "Microsofts CeBIT-Neuheiten 2002," (http://www.chip.de/artikel/c_druckansicht_9668117.html), published Mar. 13, 2002, 5 pages.

Goss, "ViewSonic ViewPad 100 with Windows and Android shown," TechRadar.com, (<http://www.techradar.com/news/mobile-computing/viewsonic-viewpad-100-with-windows-and-android-shown-714182>), published Sep. 3, 2010, 2 pages.

Grabham, "Hands on: Toshiba Folio 100 review," TechRadar.com, (<http://www.techradar.com/news/mobile-computing/tablets/hands-on-toshiba-folio-100-review-714014>), published Sep. 2, 2010, 4 pages.

Grabham, "Hands on: Viewsonic ViewPad 10 review," TechRadar.com, (<http://www.techradar.com/news/mobile-computing/tablets/hands-on-viewsonic-viewpad-10-review-714205>), published Sep. 3, 2010, 3 pages.

Heimi, "MPIO," (<http://www.heimi.net/FlashPlayer/MPIOFL100/pics/01a%20FL100Backlight.jpg>), retrieved Feb. 24, 2012, 1 page.

Heimkino Markt, "CeBIT 2004 News: Flatron Tablet—TFT-Monitor von LG mit Stifteingabemöglichkeit / Ideal für Industrie- und Designanwendungen," (<http://www.heimkinomarkt.de/News/643/LG/CeBIT%202004%20News%20FLATRON%20TabletTFT%20Monitor%20von/>), published Mar. 25, 2004, 3 pages.

Henderson, "LG Optimus Pad to take on Samsung and Apple," Pocket-lint.com, (<http://www.pocket-lint.com/news/35287/lg-optimus-pad-samsung-apple>), published Aug. 31, 2010, 1 page.

HP Compaq Tablet PC TC1000, (<http://www.hardwarezone.com.au/reviews/view.php?cid=45&id=533&pg=2>), accessed Apr. 20, 2010, 1 page.

HP Compaq Tablet PC TC1000, (<http://www.tc-one-thousand.com>), accessed Apr. 20, 2010, 2 pages.

HP Compaq Tablet PC TC1000-TM5800 1GHz-10.4" TFT, CNET Reviews, (http://reviews.cnet.com/tablet-pcs/hp-compaq-tablet-pc/4505-1707_7-20627295.html), accessed Apr. 20, 2010, 15 pages.

Itbusiness.ca, "Microsoft Mira eHome Wireless Smart Display," (http://www.itbusiness.ca/images/articles/Jun10/clip_image003_0087.jpg), accessed Nov. 15, 2011, 1 page.

iTechNews.net, "Samsung K3 MP3 Player," (<http://www.itechnews.net/2006/12/02/samsung-k3-mp3-player/>), published Dec. 2, 2006, 9 pages.

Jarrett, R. et al., Building Tablet PC Applications, pp. 38, Microsoft Press, Redmond, Washington, (2003).

JKKMobile.com, "Hanvon TouchPad BC10C tablet review," (<http://www.ikkmobile.com/2010/03/hanvon-touchpad-bc10c-tablet-review.html>), published Mar. 13, 2010, 2 pages.

Justia, "*Apple v. Samsung Electronics Co. Ltd. et al*, Filing: 427 Attachment: 42," (<http://docs.justia.com/cases/federal/district-courts/california/candce/5:2011cv01846/>), dated Nov. 28, 2011, 3 pages.

Justia, "*Apple v. Samsung Electronics Co. Ltd. et al*, Filing: 427 Attachment: 43," (<http://docs.justia.com/cases/federal/district-courts/california/candce/5:2011cv01846/239768/427/43.html>), dated Nov. 28, 2011, 3 pages.

Justia, "*Apple v. Samsung Electronics Co. Ltd. et al*, Filing: 427 Attachment: 44," (<http://docs.justia.com/cases/federal/district-courts/california/candce/5:2011cv01846/239768/427/44.html>), dated Nov. 28, 2011, 3 pages.

Justia, "*Apple v. Samsung Electronics Co. Ltd. et al*, Filing: 166 Attachment: 10," (<http://docs.justia.com/cases/federal/district-courts/california/candce/5:2011cv01846/239768/166/10.html>), dated Aug. 22, 2011, 2 pages.

Justia, "*Apple v. Samsung Electronics Co. Ltd. et al*, Filing: 166 Attachment: 11," (<http://docs.justia.com/cases/federal/district-courts/california/candce/5:2011cv01846/239768/166/11.html>), dated Aug. 22, 2011, 2 pages.

(56)

References Cited

OTHER PUBLICATIONS

- Justia, "Apple v. Samsung Electronics Co. Ltd. et al., Filing: 166 Attachment: 14," (<http://docs.justia.com/cases/federal/district-courts/california/candce/5:2011cv01846/239768/166/14.html>), dated Aug. 22, 2011, 2 pages.
- Justia, "Apple v. Samsung Electronics Co. Ltd. et al., Filing: 166 Attachment: 15," (<http://docs.justia.com/cases/federal/district-courts/california/candce/5:2011cv01846/239768/166/15.html>), dated Aug. 22, 2011, 2 pages.
- Justia, "Apple v. Samsung Electronics Co. Ltd. et al., Filing: 166 Attachment: 16," (<http://docs.justia.com/cases/federal/district-courts/california/candce/5:2011cv01846/239768/166/16.html>), dated Aug. 22, 2011, 2 pages.
- Justia, "Apple v. Samsung Electronics Co. Ltd. et al., Filing: 166 Attachment: 9," (<http://docs.justia.com/cases/federal/district-courts/california/candce/5:2011cv01846/239768/166/9.html>), dated Aug. 22, 2011, 2 pages.
- Justia, "Apple v. Samsung Electronics Co. Ltd. et al., Filing: 456 Attachment: 6," (<http://docs.justia.com/cases/federal/district-courts/california/candce/5:2011cv01846/239768/456/6.html>), dated Dec. 7, 2011, 3 pages.
- Justia, "Apple v. Samsung Electronics Co. Ltd. et al., Filing: 456 Attachment: 7," (<http://docs.justia.com/cases/federal/district-courts/california/candce/5:2011cv01846/239768/456/7.html>), dated Dec. 7, 2011, 3 pages.
- Justia, "Apple v. Samsung Electronics Co. Ltd. et al., Filing: 166 Attachment: 2," (<http://docs.justia.com/cases/federal/district-courts/california/candce/5:2011cv01846/239768/166/2.html>), dated Aug. 22, 2011.
- Justia, "Apple v. Samsung Electronics Co. Ltd. et al., Filing: 166 Attachment: 3," (<http://docs.justia.com/cases/federal/district-courts/california/candce/5:2011cv01846/239768/166/3.html>), dated Aug. 22, 2011.
- Justia, "Apple v. Samsung Electronics Co. Ltd. et al., Filing: 166 Attachment: 4," (<http://docs.justia.com/cases/federal/district-courts/california/candce/5:2011cv01846/239768/166/4.html>), dated Aug. 22, 2011.
- Justia, "Apple v. Samsung Electronics Co. Ltd. et al., Filing: 943 Attachment: 5," (<http://docs.justia.com/cases/federal/district-courts/california/candce/5:2011cv01846/239768/943/5.html>), dated May 18, 2012, 2 pages.
- Kahney, L., Cult of Mac, "Mac Air Tablet Mockup From Isamu Sanada," (<http://www.cultofmac.com/1952/mac-air-tablet-mockup-from-isamu-sanada/>), published May 6, 2008, 13 pages.
- Kahney, L., Wired, "Apple's Newton Just Won't Drop," (<http://www.wired.com/gadgets/mac/commentary/cultofmac/2002/08/54580>), published Aug. 29, 2002, 2 pages.
- KingVision, "Digital Photo Frame," (http://www.sz-kingvision.com/product.php?type_id=1&weblan=e), retrieved Nov. 21, 2011, 2 pages.
- KingVision, "DPF-1902," (http://www.sz-kingvision.com/product_disp.php?productid=24&weblan=e), retrieved Nov. 21, 2011, 3 pages.
- Knowyourmobile.com, "LG KG800 technical specifications," (http://www.knowyourmobile.com/lg/lgkg800chocolate/lgkg800reviews/137/lg_kg800_technical_specifications.html), published Mar. 9, 2007, 3 pages.
- Kowalski, M., "Review: Kodak EasyShare S730," Digital Picture Frame Review, (<http://www.digitalpictureframereview.com/2009/07/review-kodak-easyshare-s730>), published Jul. 17, 2009, 14 pages.
- Lazar, L., Cult of Mac, "Mac Pad Mock Up," (<http://www.cultofmac.com/4921/mac-pad-mock-up/>), published Nov. 19, 2008, 12 pages.
- Leachon, "IFA 2010: Toshiba's FOLIO 100 Tablet has Android, Flash and nice price tag," ShinyShiny.tv, (http://www.shinyshiny.tv/2010/09/ifa_2010_toshiba_folio_100.html), published Sep. 2, 2010, 2 pages.
- Lerg, A., T Online, "Billig-Tablet-Computer vom Grabbeltisch," (http://digitalleben.t-online.de/tablet-pc-von-jay-tech-fuer-140-euro-bei-rossmann/id_43326132/index), published Mar. 11, 2010, 2 pages.
- Long, B., Macworld, "PL500 LCD Pen Tablet System," (<http://images.macworld.com/images/legacy/2001/02/images/content/wacom.gif>), published Feb. 1, 2001, 1 page.
- Long, B., Macworld, "PL500 LCD Pen Tablet System," (<http://www.macworld.com/article/1938/2001/02/wacomtablet.html>), published Feb. 1, 2001, 1 page.
- Loyola, R., MacWorld.com, "First Look: Axiotron Modbook Pro," (<http://www.macworld.com/article/137878/2009/01/mwvodcast86.html>), published Jan. 6, 2009, 2 pages.
- Markoff, "A Media Pioneer's Quest: Portable Electronic Newspapers," New York Times Sunday Business Edition, published Jun. 28, 1992, 1 page.
- Martin, T., "The Tablet Newspaper: A Vision for the Future," Human Factors in Computing Systems, Chi '95 Conference Companion, pp. 425, Colorado, United States (May 1995).
- McCracken, "The iPad. Of 2000. As Envisioned in 1988," Technologizer.com, (<http://technologizer.com/2010/05/14/the-ipad-of-2000-as-envisioned-in-1988/>), published May 14, 2010, 12 pages.
- Mel et al., "Tablet: Personal Computer in the Year 2000," *Communications of the ACM* 31:638-646, ACM (Jun. 1988).
- Metz, C., PC Magazine, "HP Compaq Tablet PC TC1000," (<http://www.pcmag.com/article2/0,2817%20,939500,00.asp>), published Apr. 8, 2003, 3 pages.
- Microsoft, "Bill Gates Highlights the Magic of Consumer Software And the Coming Digital Decade at Consumer Electronics Show," (<http://www.microsoft.com/presspass/press/2002/jan02/01-07ces2002keynotepr.mspx>), published Jan. 7, 2002, 3 pages.
- Miles, "56 Apple iTablet concept designs: Could any be real?," (<http://www.pocket-lint.com/news/26500/56-apple-itablenet-concept-designs>), published Aug. 21, 2009, 14 pages.
- Miles, "BlackBerry PlayBook: RIM launches tablet," Pocket-lint.com, (<http://www.pocket-lint.com/news/35893/rim-blackberrv-playbook-tablet-device>), published Sep. 27, 2010, 8 pages.
- Miller, "MSI shows off 10-inch Android tablet running new Tegra chipset," Engadget.com, (<http://www.engadget.com/2010/01/08/msi-shows-off-10-inch-android-tablet-running-new-tegra-chipset/>), published Jan. 8, 2010, 11 pages.
- Mobilegazette.com, "Nokia N92," (<http://www.mobilegazette.com/nokia-n92-051102.htm>), published Nov. 2, 2005, 2 pages.
- Monitor4u, "Flatron L1530TM," (<http://www.monitor4u.co.kr/review/review4u/content.asp?idx=580&leftcode=16>), published Mar. 17, 2004, 7 pages.
- My Burmese Blog, "Apple Touch Screen Netbook Prototypes Hit The Web," (<http://www.htootayzar.com/myblog/2009/03/apple-touch-screen-netbook-prototypes-hit-the-web/>), published Mar. 12, 2009, 10 pages.
- Needleman, "Hands-on with the JooJoo," (http://news.cnet.com/8301-19882_3-10410960-250.html), CNET News, published Dec. 7, 2009, 31 pages.
- Netzwelt, "Rollei DF8 DVB-T," (<http://www.netzwelt.de/news/81537-rollei-df8-dvb-t-test-digitaler-bilderrahmen-mini-fernseher.html>), retrieved Nov. 21, 2011, 10 pages.
- NewGadgets, "Mysteriöser Tablet-PC?," (<http://www.newgadgets.de/6072/mysteriöser-tablet-pc/>), retrieved Jun. 1, 2011, 6 pages.
- Newlaunches.com, "Pidion BM-200 sleek Windows CE PDA phone from Bluebird," (http://www.newlaunches.com/archives/pidion_bm200_sleek_windows_ce_pda_phone_from_bluebird.php), published Dec. 15, 2005, 3 pages.
- Nguyen, "Hannspree's Hannspad Tablet Runs Android 2.2 with Custom UI," Ubergizmo.com, (<http://www.ubergizmo.com/2010/11/hannsprees-hannspad-tablet-runs-android-id-2-2-with-custom-ui/>), published Nov. 18, 2010, 1 page.
- NotebookCheck, "Fujitsu-Siemens Stylistic ST5022," (<http://www.notebookcheck.com/typo3temp/pics/d675d29c1f.jpg>), retrieved Sep. 26, 2011, 1 page.
- NYTimes.com, "iRiver U10 (1GB)," (<http://www.nytimes.com/technology/personaltech/music-players/iRiver-U10-1GB-31432102.html>), published Feb. 12, 2012, 2 pages.
- Old Computers, "Toshiba T100-X Dynapad," (<http://www.old-computers.com/museum/computer.asp?st=1&c=801>), product released 1993, 2 pages.
- Oullette, D., "Dynapad weighs in at just 3.3 pound," Info World, vol. 15, Issue 31, Aug. 2, 1993, 2 pages.

(56)

References Cited

OTHER PUBLICATIONS

Patel, "The HP Slate" (<http://www.engadget.com/2010/01/06/the-hp-slate/>), Engadget.com, published Jan. 6, 2010, 4 pages.

PDA Museum, "Sony Clie," (http://www.pdamuseum.com/sony_clie/clie_pics/th-55j2.jpg), retrieved Feb. 26, 2012, 1 page.

PDADB.net, "Acer n20 Specs," (<http://pdadb.net/index.php?m=specs&id=257&c=acern20>), published May 13, 2005, 3 pages.

PDADB.net, "Casio Cassiopeia IT-10 M20BR Specs," (http://pdadb.net/index.php?m=specs&id=95&c=casio_cassiopeia_it-10_m20br), published Dec. 30, 2004, 3 pages.

PDADB.net, "Dell Axim X3 Basic Specs," (http://pdadb.net/index.php?m=specs&id=81&c=dell_axim_x3_basic), published Dec. 30, 2004, 3 pages.

PDADB.net, "MiTAC Mio 338 Plus Digi-Walker Specs," (http://pdadb.net/index.php?m=specs&id=60&c=mitac_mio_338_plus_digi-walker), published Dec. 25, 2004, 3 pages.

PDADB.net, "O2 XDA (HTC Wallaby) Specs," (http://pdadb.net/index.php?m=specs&id=117&c=o2_xda_htc_wallaby), published Feb. 3, 2005, 3 pages.

PDADB.net, "Sony Clie PEG-SL10 / PEG-SL10U / PEG-SL10E Specs," (http://pdadb.net/index.php?m=specs&id=1198&c=sony_clie_peg-sl10_peg-sl10u_peg-sl10e), published Mar. 4, 2008, 3 pages.

PDADB.net, "Sony Clie PEG-T665C / PEG-T675C Specs," (http://pdadb.net/index.php?m=specs&id=1192&c=sony_clie_peg-t665c_peg-t675c), published Mar. 4, 2008, 3 pages.

PDADB.net, "Toshiba Genio e330 Specs," (http://pdadb.net/index.php?m=specs&id=29&c=toshiba_genio_e330), published Dec. 9, 2004, 3 pages.

PDADB.net, "Toshiba Genio e570 Specs," (http://pdadb.net/index.php?m=specs&id=229&c=toshiba_genio_e570), published May 4, 2006, 3 pages.

Perton, "Samsung digital picture frame stores pics, movies, music," Engadget, (<http://www.engadget.com/2006/03/09/samsung-digital-picture-frame-stores-pics-movies-music/>), published Mar. 9, 2006, 1 page.

Potter, "Enter the E-Paper," *Presstime*, published Aug. 1993, pp. 18-19.

RadioShack, "Motorola DEFY with Motoblur Black," (http://radioshackwireless.com/eCommerce/SpecialOffer.aspx?cid=25578_47f08265355e4a8a92dcd57eed6cbc69), 1 page.

Ricker, "LG's KE850 Prada official: iPhone says, wha?" Engadget.com, (<http://www.engadget.com/2007/01/18/lgs-ke850-prada-official-iphone-says-wha/>), published Jan. 18, 2007, 4 pages.

Ricker, "The Pidion BM-200: it's time to move to Seoul," (<http://www.engadget.com/2005/10/04/the-pidion-bm-200-its-time-to-moye-to-seoul/>), Engadget.com, published Oct. 4, 2005, 4 pages.

Rojas, "Hands-on with the Nokia N92," Engadget.com, (<http://www.engadget.com/2005/12/01/hands-on-with-the-nokia-n92/>), published Dec. 1, 2005, 4 pages.

Rothman, "HP's Windows 7 Slate Device Revealed by Steve Ballmer," Gizmodo.com, (<http://www.gizmodo.com/5442200/hps-windows-7-slate-device-revealed-by-steve-ballmer>), published Jan. 6, 2010, 2 pages.

S. Dimitris, "Pidion BM200 Smartphone," PDASNews, (www.pdasnews.com/articles/pidion-bm200-smartphone.html), accessed Mar. 7, 2012, 2 pages.

Salestores.com, "LG L1530TM Tablet LCD Monitor," (<http://salestores.com/lgl1talcdmos.html>), accessed Nov. 17, 2011, 2 pages.

Samsung, "Samsung Introduces UltraThin Touch of Color Photo Frame," (http://www.samsung.com/us/news/newsPreviewRead.do?news_seq=13462), published May 23, 2009, 2 pages.

Samsung, "Samsung's Digital Photo Frames," (http://www.samsung.com/hk_en/consumer/detail/productPreviewRead.do?model_cd=LPO8IPLSB/XK&group=photography&type=photo-frame&subtype=photo-frame), retrieved Nov. 21, 2011, 4 pages.

Sandeep, "LG Optimus Pad with Honeycomb Launching at MWC 2011," Fonearena.com, (<http://www.fonearena.com/blog/30270/lg-optimus-pad-with-honeycomb-launching-at-mwc-2011.html>), published Feb. 4, 2011, 1 page.

Savov, "LG Pad coming in Q1 2011, with Android Honeycomb, dual-core Tegra 2, and 8.9-inch screen," Engadget.com, (<http://www.engadget.com/2010/11/03/lg-pad-coming-in-early-2011-with-android-honeycomb-dual-core-t/>), published Nov. 3, 2010, 1 page.

Savov, V., Engadget, "Nvidia Tegra tablet prototype hands-on," (<http://www.engadget.com/2009/11/27/nvidia-tegra-tablet-prototype-hands-on/>), published Nov. 27, 2009, 5 pages.

Savov, V., Engadget, "Nvidia Tegra tablet prototype hands-on," (<http://www.engadget.com/photos/nvidia-tegra-tablet-prototype/#2485983>), published Nov. 27, 2009, 2 pages.

Savov, V., Engadget, "Nvidia Tegra tablet prototype hands-on," (<http://www.engadget.com/photos/nvidia-tegra-tablet-prototype/#2485984>), published Nov. 27, 2009, 2 pages.

Savov, V., Engadget, "Nvidia Tegra tablet prototype hands-on," (<http://www.engadget.com/photos/nvidia-tegra-tablet-prototype/#2485985>), published Nov. 27, 2009, 2 pages.

Savov, V., Engadget, "Nvidia Tegra tablet prototype hands-on," (<http://www.engadget.com/photos/nvidia-tegra-tablet-prototype/#2485986>), published Nov. 27, 2009, 2 pages.

Savov, V., Engadget, "Nvidia Tegra tablet prototype hands-on," (<http://www.engadget.com/photos/nvidia-tegra-tablet-prototype/#2485987>), published Nov. 27, 2009, 2 pages.

Savov, V., Engadget, "Nvidia Tegra tablet prototype hands-on," (<http://www.engadget.com/photos/nvidia-tegra-tablet-prototype/#2485988>), published Nov. 27, 2009, 2 pages.

Savov, V., Engadget, "Nvidia Tegra tablet prototype hands-on," (<http://www.engadget.com/photos/nvidia-tegra-tablet-prototype/#2485989>), published Nov. 27, 2009, 2 pages.

Savov, V., Engadget, "Nvidia Tegra tablet prototype hands-on," (<http://www.engadget.com/photos/nvidia-tegra-tablet-prototype/#2485990>), published Nov. 27, 2009, 2 pages.

Savov, V., Engadget, "Nvidia Tegra tablet prototype hands-on," (<http://www.engadget.com/photos/nvidia-tegra-tablet-prototype/#2485991>), published Nov. 27, 2009, 2 pages.

Savov, V., Engadget, "Nvidia Tegra tablet prototype hands-on," (<http://www.engadget.com/photos/nvidia-tegra-tablet-prototype/#2485992>), published Nov. 27, 2009, 2 pages.

Schulze, S. And Gratz, I., "1999 | Studio Display," in *Apple Design*, pp. 144-145, Hatje Cantz Verlag, Ostfildern, Germany (2011).

Scott, "LG Announces LG Optimus Pad at Dealer Days in Brussels," Netbooknews.com, (<http://www.netbooknews.com/7518/lg-announces-lg-optimus-pad-at-dealer-days-in-brussels/>), published Aug. 31, 2010, 4 pages.

Scott, "Motorola Xoom Android 3.0 Tablet Goes Official," Netbooknews.com, (<http://www.netbooknews.com/17229/motorola-xoom-android-3-0-tablet-goes-official/>), published Jan. 6, 2011, 6 pages.

Scrapin_frame, s10forum, "fs: 2 lg flatron tablet monitors," (<http://www.s10forum.com/forum/f296/fs-2-lg-flatron-tablet-monitors-483210/>), published Nov. 27, 2011, 5 pages.

Sierra, LaptopsArena, "Amtek Releases the iTablet T221 Tablet PC, Laptops Arena," (<http://www.laptopsarena.com/amtek-releases-the-it-tablet-t221-tablet-pc/>), published Dec. 22, 2007, 5 pages.

Smith, C., HuffPost Tech, "History of Tablet PCs (Photos): A Pictorial Timeline of Tablets, From Rand to the iPad," (http://www.huffingtonpost.com/2010/04/15/history-tablet-pc-photos_n_538806.html), published Apr. 15, 2010, 5 pages.

Smith, reghardware.com, "First fondleslab found in 1970s kids TV sci-fi gem: Apple iPad inspired by Tomorrow People," (http://www.reghardware.com/2011/02/07/apple_ipad_tomorrow_people/), published Feb. 7, 2011, 3 pages.

Softgate, "Fujifilm FinePix Real 3D V1," (http://www.softgate.ch/ger_details_31383/Fujifilm_FinePix_Real_3D_V1_Viewer_8_TFT.html), published Apr. 16, 2010, 2 pages.

Sony, "The Sony Clie PEG-TH55 heralds The Next Generation of Digital Organisers," (<http://dpnow.com/595.html>), published Feb. 13, 2004, 2 pages.

Stevens, "ICD confirms Vega tablet, includes Android 2.0, Tegra processor, our hearts," Engadget.com, (<http://www.engadget.com/2009/11/13/icd-confirms-vega-tablet-includes-android-2-0-tegra-processor/>), published Nov. 13, 2009, 2 pages.

(56)

References Cited

OTHER PUBLICATIONS

Sung, "Motorola Xoom vs Apple iPad," Pocket-lint.com, (<http://www.pocket-lint.com/news/37732/motorola-xoom-vs-apple-ipad/>), published Jan. 6, 2011, 3 pages.

Sze, iTechNews Net, "Amtek has five iTablets for the Computex 2010," (<http://www.itechnews.net/2010/05/27/amtek-has-five-itables-for-the-computex-2010/>), retrieved Jun. 3, 2011, 13 pages.

Tan, K., Shanghaiist, "ZOMG! Maker of Chinese iPad clone P88 to sue Apple for cloning its tablet!," (<http://shanghaiist.com/2010/01/29/p88-chinese-ipad-clone-sues-apple.php>), published Jan. 29, 2010, 5 pages.

Tatung, "Comdex Fall 2003 Tatung Booth# 10248," (<http://www.tatung.com/en/news/comdex2003.htm>), published Nov. 17, 2003, 2 pages.

TechLahore.com, "China's Boeye releases 'Apple tablet' before Apple can—TechLahore@GITEX," (<http://www.techlahore.com/2009/11/08/chinas-boeye-releases-apple-tablet-before-apple-can-techlahoregitex/>), published Nov. 8, 2009, 3 pages.

Testberichte.de, "Fuji FinePix Real 3D V1," (<http://www.testberichte.de/p/philips-tests/digital-photoframe-sph8008-testbericht.html>), retrieved Nov. 21, 2011, 3 pages.

Testberichte.de, "Philips Digital PhotoFrame SPH8008," (<http://www.testberichte.de/p/philips-tests/digital-photoframe-sph8008-testbericht.html>), retrieved Nov. 21, 2011, 4 pages.

The Apple Collection, "Apple PowerPad G3 Pro—Apple Design & Prototype," (www.theapplecollection.com/design/macdesign/Apple_PowerPad_G3_Pro.shtml), updated Oct. 31, 2011, 2 pages.

The Apple Collection, "MyPal," (www.theapplecollection.com/design/macdesign/MyPal.shtml), updated Oct. 31, 2011, 2 pages.

The Apple Collection, "PowerPad," (www.theapplecollection.com/design/macdesign/PowerPad2.shtml), updated Oct. 31, 2011, 2 pages.

The Best of CES 2010, (http://www.pcworld.com/article/186511/another_excellent_ereader.html), accessed Apr. 26, 2010, 1 page.

Tingle, "ICD Vega Android 2.0 Tablet Available in 2010 [Vega Android Tablet, Nvidia Tegra Chipset Touting 'Low Cost Tablet' Confirmed]," (<http://nexus404.com/Blog/2009/11/13/icd-vega-android-2-0-tablet-available-in-2010-vega-android-tablet-nvidia-tegra-chipset-touting-low-cost-tablet-confirmed/>), TFTS, published Nov. 13, 2009, 2 pages.

To, "Boeye MID 700 tablet runs Android with Apple-esque aesthetics," Pocketables.com, (<http://www.pocketables.net/2009/11/boeye-mid-700-tablet-runs-android-with-applesque-aesthetics.html>), published Nov. 12, 2009, 2 pages.

Topolsky, "Leaked pics of the CrunchPad make it look dangerously close to availability," Engadget.com, (<http://www.engadget.com/2009/04/09/leaked-pics-of-the-crunchpad-make-it-look-dangerously-close-to-a/>), published Apr. 9, 2009, 2 pages.

Topolsky, "Nvidia CEO shows off mystery tablet, makes zero statements about mystery tablet," Engadget.com, (<http://www.engadget.com/2009/11/09/nvidia-ceo-shows-off-mystery-tablet-makes-zero-statements-about/>), published Nov. 9, 2009, 1 page.

Topolsky, J., Engadget, "Amtek intros the iTablet T221 UMPC," (<http://www.engadget.com/2007/12/18/amtek-intros-the-itab-t221-umpc/>), published Dec. 18, 2007, 3 pages.

Toshiba, "Toshiba Dynapad T100X Pen Computer," product announced Nov. 1992, 2 pages.

Touch User Guide, "What will the new Apple Tablet look like? Apple tablet images leaked?," (<http://www.touchuserguide.com/2009/07/29/what-will-the-new-apple-tablet-look-like/>), published Jul. 29, 2009, 29 pages.

Toxel.com, "12 Cool Apple Tablet Concepts," (<http://www.toxel.com/tech/2009/08/31/12-cool-apple-tablet-concepts/>), published Aug. 31, 2009, 16 pages.

Van Reeth, J., "Vantage is showing its colours!," *Home automation journal* 11:1-8, Vantage Emea, Belgium (Jun. 2003).

Verkehrsrundschau, "Details zum Digitalen Bilderrahmen," (http://www.verkehrsrundschau.de/fotowettbewerb-mein-tag-der-logistik-835123.html?_apg=2), published Apr. 27, 2009, 1 page.

Vilas-Boas, "Industrial Design Portfolio," (<http://rdvb-designshowcase.blogspot.com/p/cheddar-1-2009.html>), published 2004, 6 pages.

Wacom, "Company History, PL-500," (<http://wacom.jp/en/company/history/>), product released Jun. 2000, 1 page.

WebdesignerDepot.com, "The Evolution of Cell Phone Design Between 1983-2009" (<http://www.webdesignerdepot.com/2009/05/the-evolution-of-cell-phone-design-between-1983-2009/>), accessed May 6, 2011, 56 pages.

Weiss, "Hands-On: Nvidia Tegra Tablet Prototyp ICD Vega (Video)," (<http://de.engadget.com/2009/11/28/hands-on-nvidia-tegra-tablet-prototyp-icd-vega-video/>), Engadget German, published Nov. 28, 2009, 13 pages.

Wikimedia, "MPIO," (http://upload.wikimedia.org/wikipedia/commons/e/e9/M-Pio_FL100.jpg), retrieved Feb. 24, 2012, 1 page.

Wikipedia, "Axiotron Modbook," (http://en.wikipedia.org/wiki/Axiotron_Modbook), updated Apr. 18, 2011, 4 pages.

Wikipedia, "Datei:Modbook pro.jpg," (http://de.wikipedia.org/wiki/Datei:Modbook_pro.jpg), taken Jan. 9, 2009, 4 pages.

Wikipedia, "Datei:VIA Tablet PC Reference Design.jpg," (http://de.wikipedia.org/wiki/Datei:VIA_Tablet_PC_Reference_Design.jpg), taken Nov. 16, 2007, 3 pages.

Wikipedia, "Dynabook," (<http://de.wikipedia.org/wiki/Dynabook>), updated Apr. 2, 2011, 2 pages.

Wikipedia, "Etch A Sketch," (http://en.wikipedia.org/wiki/Etch_a_sketch), last modified Jul. 17, 2011, 4 pages.

Wikipedia, "MessagePad," (<http://en.wikipedia.org/wiki/Messagepad>), retrieved Sep. 12, 2011, 10 pages.

Wikipedia, "Tablet-Computer," (<http://de.wikipedia.org/wiki/Tablet-Computer>), updated Apr. 7, 2011, 3 pages.

Wikipedia, "Tablet-PC," (<http://de.wikipedia.org/wiki/Tablet-PC>), retrieved Apr. 14, 2011, 2 pages.

Wikipedia.org, "Clíé," (<http://en.wikipedia.org/wiki/CLÍ%C3%89>), last modified Feb. 12, 2011, 3 pages.

Wikipedia.org, "E-Ten," (<http://en.wikipedia.org/wiki/E-TEN>), last modified Dec. 15, 2010, 2 pages.

Wikipedia.org, "File:LG KE850 Prada Hauptmenü.jpg," (http://en.wikipedia.org/wiki/File:LG_KE850_Prada_Hauptmen%C3%BC.jpg), accessed Feb. 12, 2012, 4 pages.

Wikipedia.org, "iPAQ," (<http://en.wikipedia.org/wiki/IPAQ>), last modified May 4, 2011, 7 pages.

Wikipedia.org, "Pocket viewer," (http://en.wikipedia.org/wiki/Pocket_viewer), last modified Apr. 10, 2011, 4 pages.

Wikipedia.org, "Zire Handheld," (http://en.wikipedia.org/wiki/Zire_Handheld), last modified Dec. 11, 2010, 4 pages.

Wiley, M., Ign, "MPIO FL100 Review," (<http://uk.ign.com/articles/2003/01/21/mpio-fl100-review>), published Jan. 21, 2003, 4 pages.

Yatego Shopping, "Lenco Digitaler Bilderrahmen DF-911 B," (<http://www.yatego.com/index.htm?cl=spotshopping&popup=media&pid=4a13d0ce891ff>), retrieved Nov. 21, 2011, 1 page.

ZDNet, "Viewsonic V1100," (<http://www.zdnet.nl/reviews/24712/viewsonic-v1100/>), published Feb. 17, 2003, 9 pages.

Apple's reply in Support of its Motion for a Preliminary Injunction (Redacted), p. 11, *Apple Inc. v. Samsung Electronics Co., Ltd.*, United States District Court, Northern District of California, San Jose Division, Case No. 11-cv-01846-LHK, dated Oct. 13, 2011, 38 pages total.

Case-Parts, "Original Targus Folding Genuine Leather Case for Apple iPad with Built-in Holder," <http://www.case-parts.com/details/Original-Targus-Folding-Genuine-Leather-Case-for-Apple-iPad-with-Built-in-Holder-IPAD-570/photos.htm>, 3 pages.

<http://www.case-parts.com>, captured Nov. 4, 2011; "Leather Flip Sleeve Case Cover with Holder for iPad", published 2010.

<http://www.case-parts.com>, captured Oct. 18, 2011; "Original Targus Folding Genuine Leather Case for Apple iPad with Built-in Holder", published 2010.

<http://switcheasy.com>, captured Oct. 17, 2011; "TRIG For iPad/iPad 2", published 2011.

* cited by examiner



FIG. 1

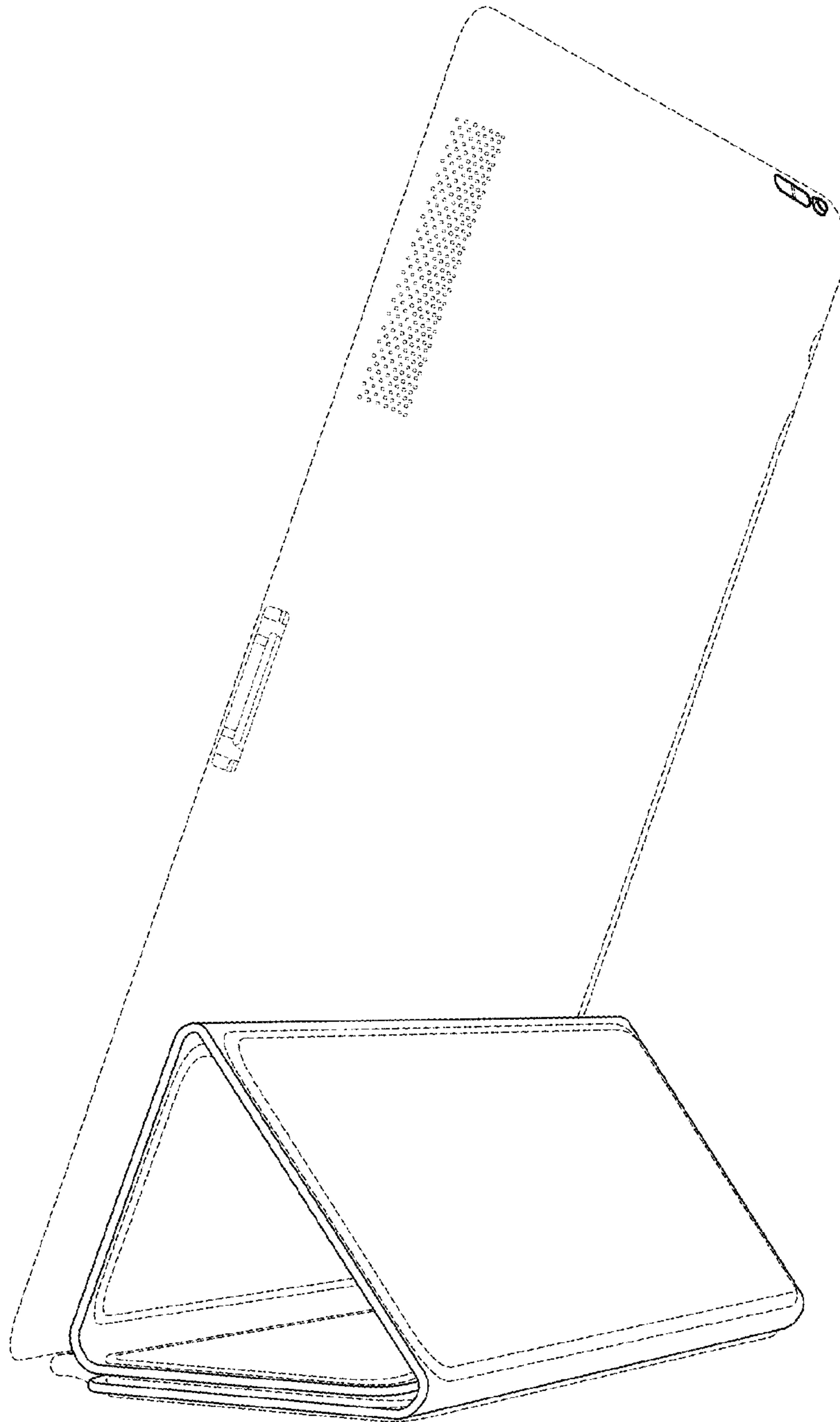

FIG. 2

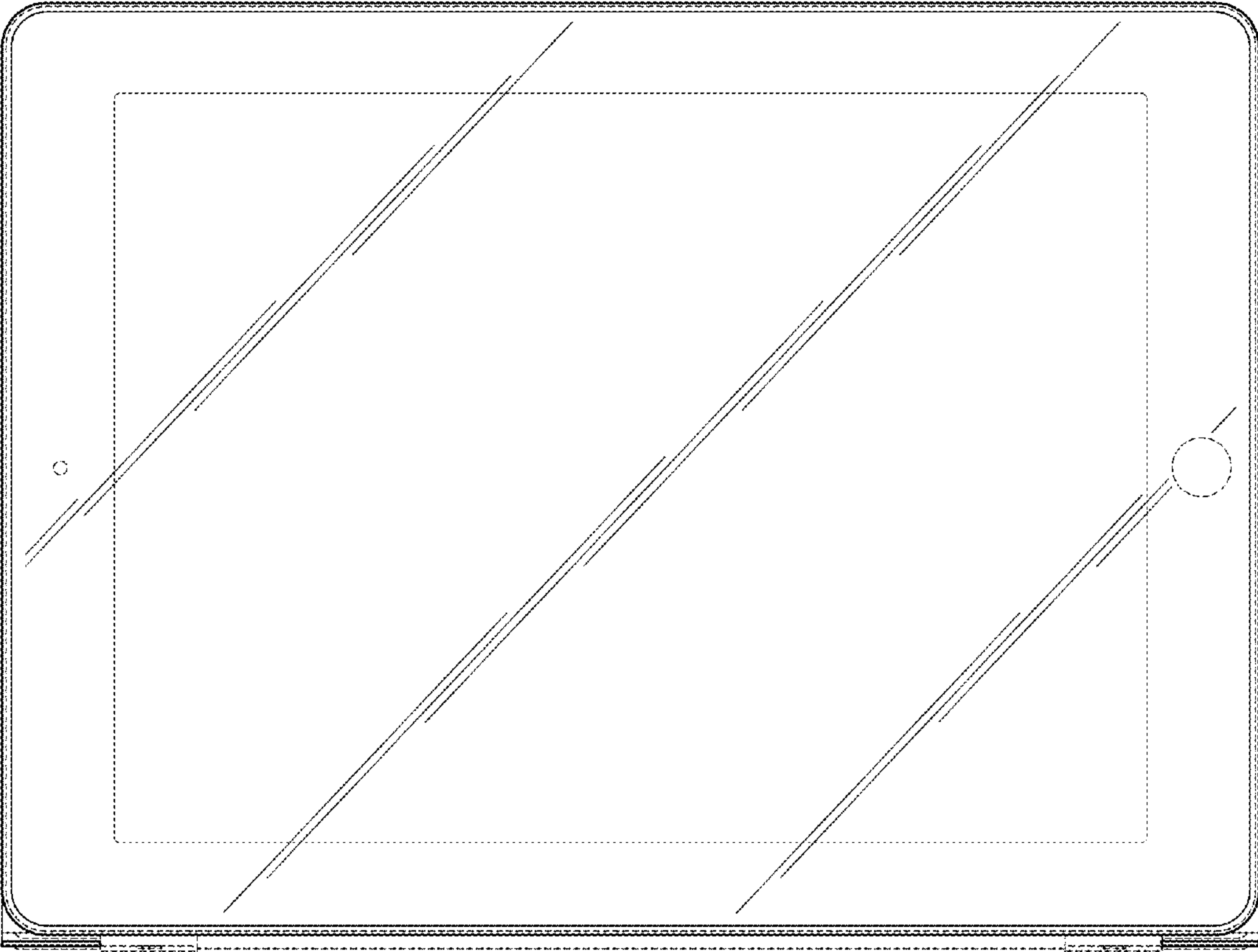

FIG. 3

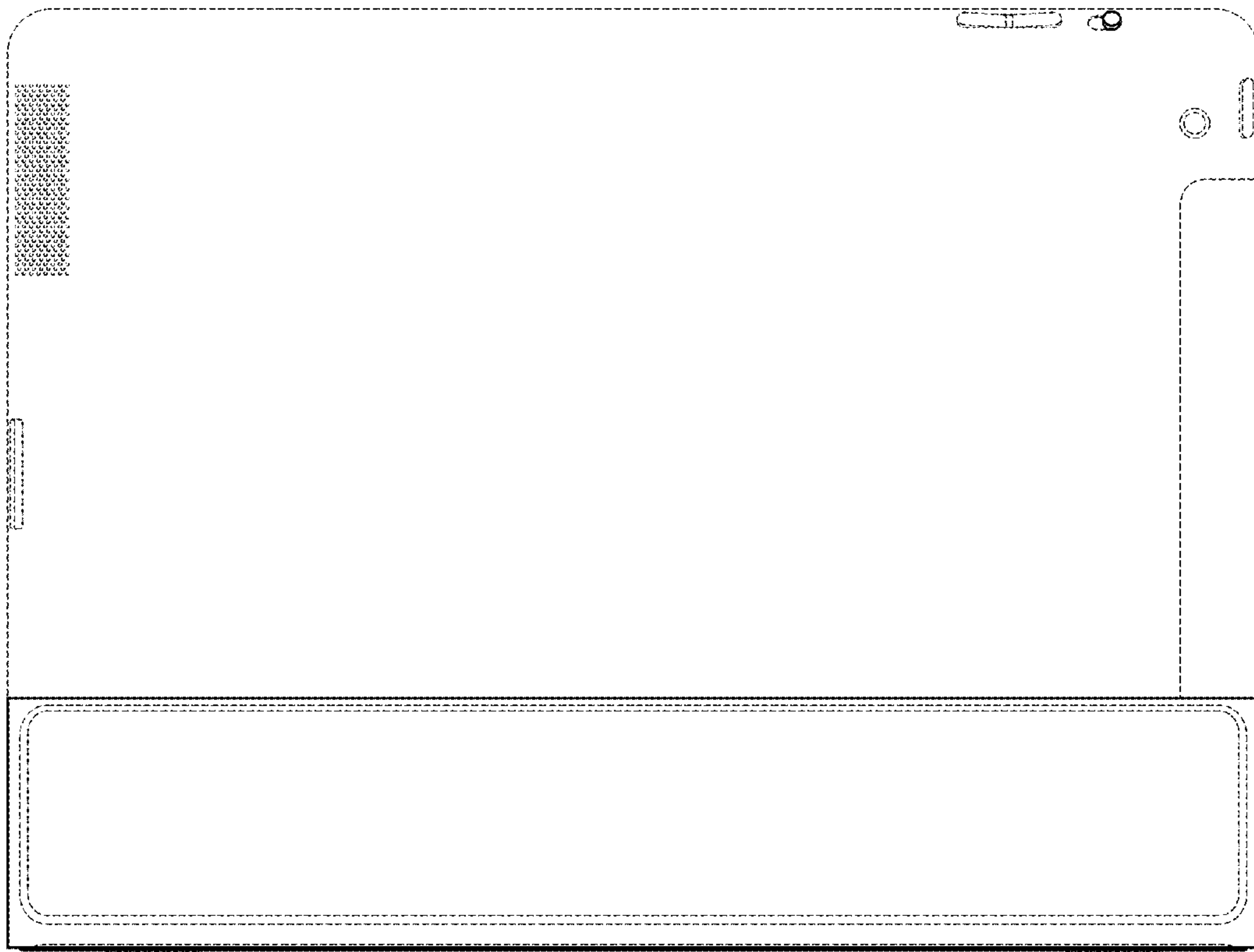

FIG. 4

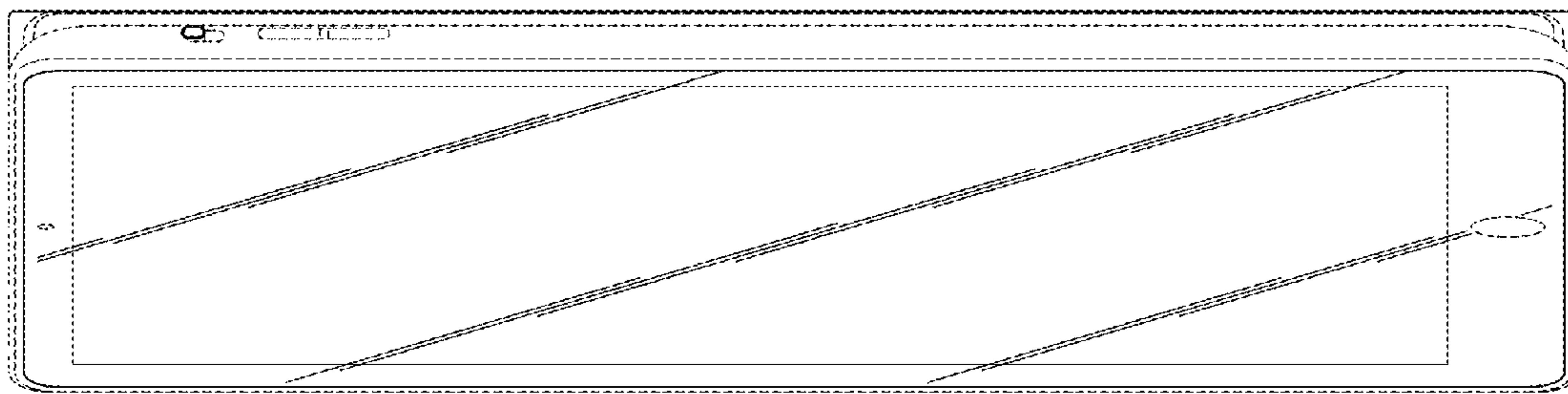

FIG. 5

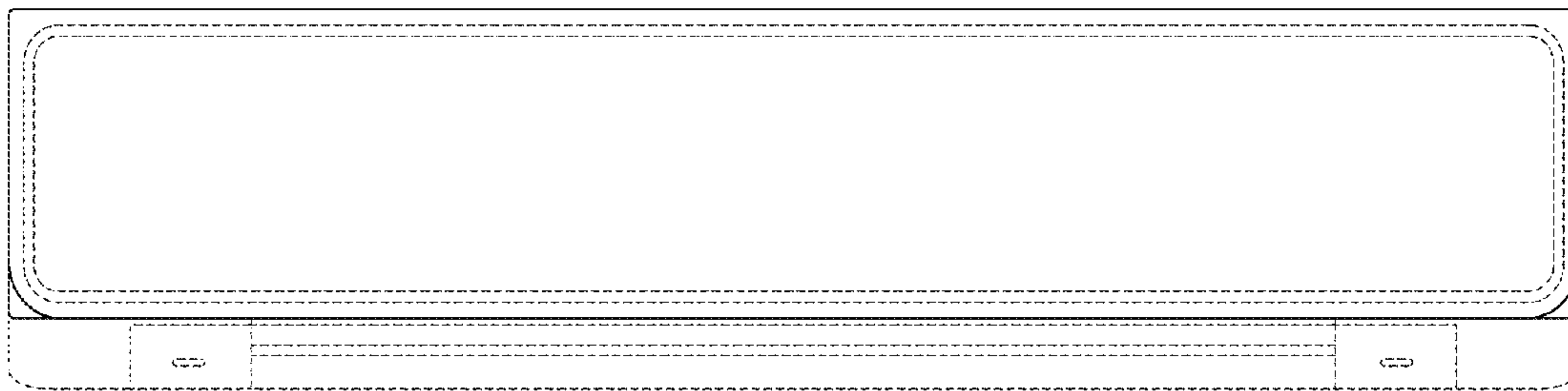

FIG. 6

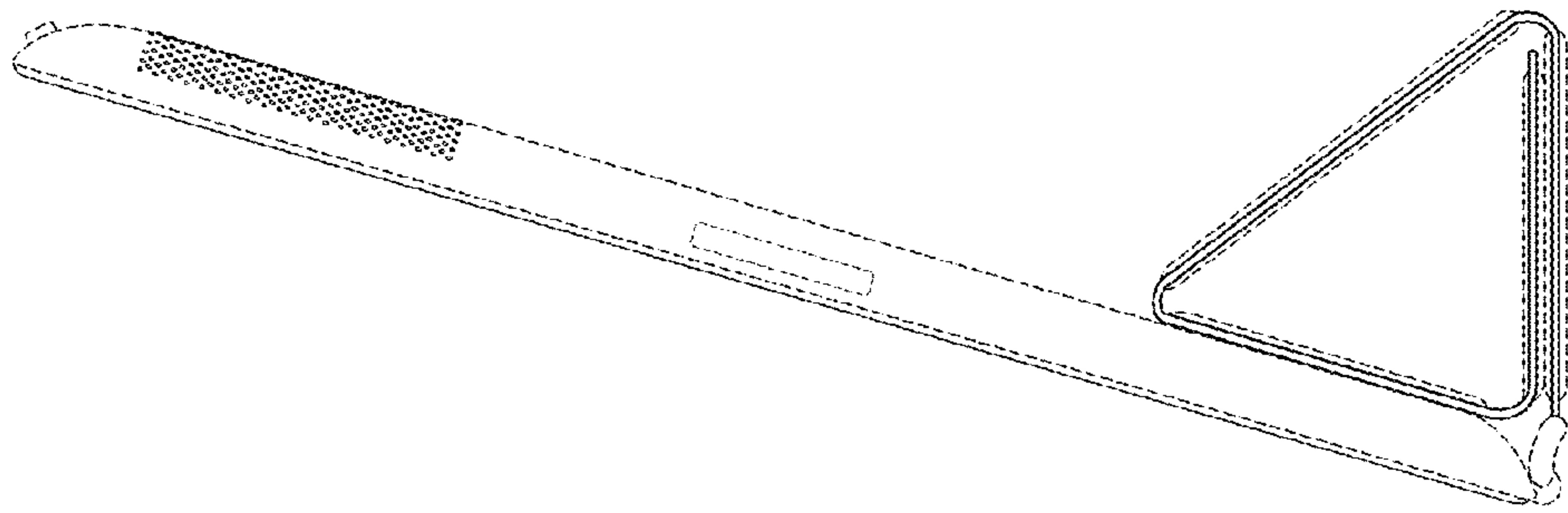

FIG. 8

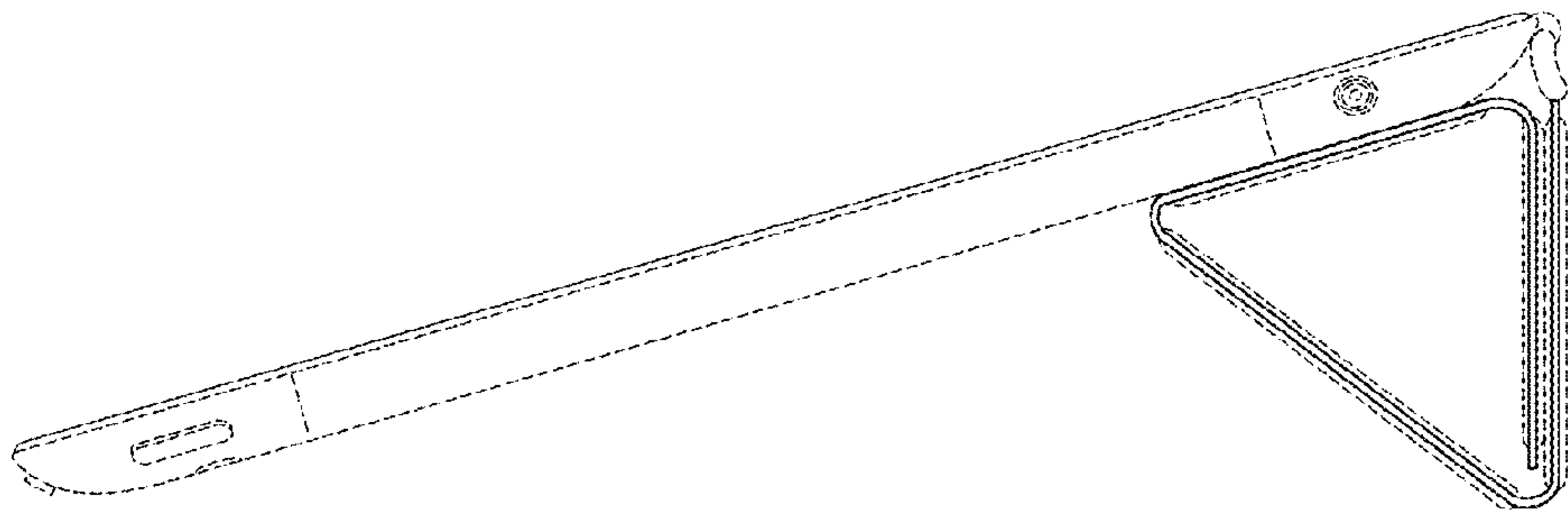

FIG. 7

UNITED STATES PATENT AND TRADEMARK OFFICE
CERTIFICATE OF CORRECTION

PATENT NO. : D704,702 S
APPLICATION NO. : 29/437767
DATED : May 13, 2014
INVENTOR(S) : Jody Akana et al.

Page 1 of 5

It is certified that error appears in the above-identified patent and that said Letters Patent is hereby corrected as shown below:

Title page, illustrative fig(s). 2 should be deleted and substitute therefore the attached title page consisting of illustrative fig(s). 2.

In the Drawings

The drawing sheets 2 and 4-5 of 6 consisting of fig(s) 2, 4, 5 and 6 should be deleted and substitute therefore the attached drawing sheets consisting of the same.

Signed and Sealed this
Fifth Day of July, 2016



Michelle K. Lee
Director of the United States Patent and Trademark Office

(12) **United States Design Patent**
Akana et al.

(10) Patent No.: **US D704,702 S**
(45) Date of Patent: ** *May 13, 2014

(54) **PORTABLE DISPLAY DEVICE WITH COVER**

(71) Applicant: Apple Inc., Cupertino, CA (US)

(72) Inventors: Jody Akana, San Francisco, CA (US);
Bartley K. Andre, Palo Alto, CA (US);
Jeremy Batallou, San Francisco, CA
(US); Daniel J. Coster, San Francisco,
CA (US); Daniele De Iulio, San
Francisco, CA (US); M. Evans Hankey,
San Francisco, CA (US); Julian Hoemig,
San Francisco, CA (US); Richard P.
Howarth, San Francisco, CA (US);
Jonathan P. Iye, San Francisco, CA
(US); Duncan Robert Kerr, San
Francisco, CA (US); Shin Nishihori,
Kailua, HI (US); Matthew Dean
Rohrbach, San Francisco, CA (US);
Peter Russell-Clarke, San Francisco,
CA (US); Christopher J. Stringer,
Woodside, CA (US); Eugene Antony
Whang, San Francisco, CA (US); Rico
Zörkendörfer, San Francisco, CA (US)

(73) Assignee: Apple Inc., Cupertino, CA (US)

(*) Notice: This patent is subject to a terminal dis-
claimer.

(**) Term: 14 Years

(21) Appl. No.: 29/437,767

(22) Filed: Nov. 20, 2012

Related U.S. Application Data

(63) Continuation of application No. 29/386,263, filed on
Feb. 25, 2011, now Pat. No. Des. 671,114.

(51) LOC (10) CL 14-02

(52) U.S. CL
USPC D14/341

(58) Field of Classification Search
USPC D14/341-347, 336, 337, 371, 374, 138,
D14/496, 440; D10/65; 345/901, 104, 133,
345/156, 168, 173; 348/180, 184, 325, 739,
348/373, 376; 385/88; 710/62; 455/575.3,
455/575.1; D19/60; 361/679.27; 178/18.03;
434/317

See application file for complete search history.

(56) **References Cited**

U.S. PATENT DOCUMENTS

2,424,630 A 7/1947 Perez
4,259,568 A * 3/1981 Dynesen 235/1 D
(Continued)

FOREIGN PATENT DOCUMENTS

AU 315078 7/2007
CA 72548 5/1993
(Continued)

OTHER PUBLICATIONS

"A Day in the Life of InfoLink." Stanford University Libraries, pub-
lished May 1, 2003.

(Continued)

Primary Examiner — Barbara Fox

(74) Attorney, Agent, or Firm — Sterne, Kessler,
Goldstein & Fox P.L.L.C.

(57) **CLAIM**

The ornamental design for a portable display device with
cover, as shown and described.

DESCRIPTION

FIG. 1 is a left front perspective view of a portable display
device with cover showing our new design, with the cover in
a folded position;

FIG. 2 is a right rear perspective view thereof;

FIG. 3 is a front view thereof;

FIG. 4 is rear view thereof;

FIG. 5 is a top view thereof;

FIG. 6 is a bottom view thereof;

FIG. 7 is a left side view thereof; and,

FIG. 8 is a right side view thereof.

The broken lines in the Figures show portions of the portable
display device with cover which form no part of the claimed
design.

The shade lines in the Figures show transparency, and not
surface ornamentation.

1 Claim, 6 Drawing Sheets

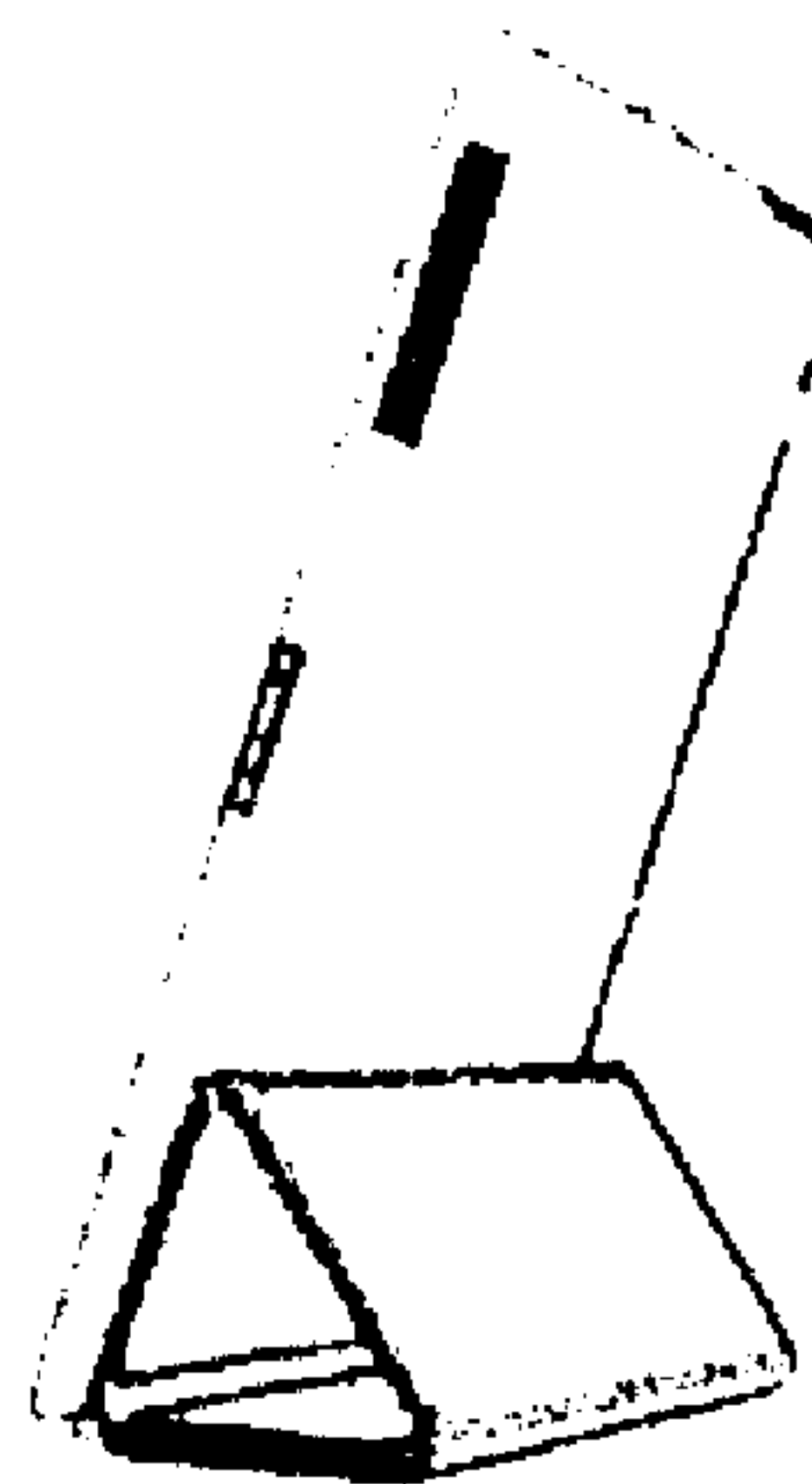
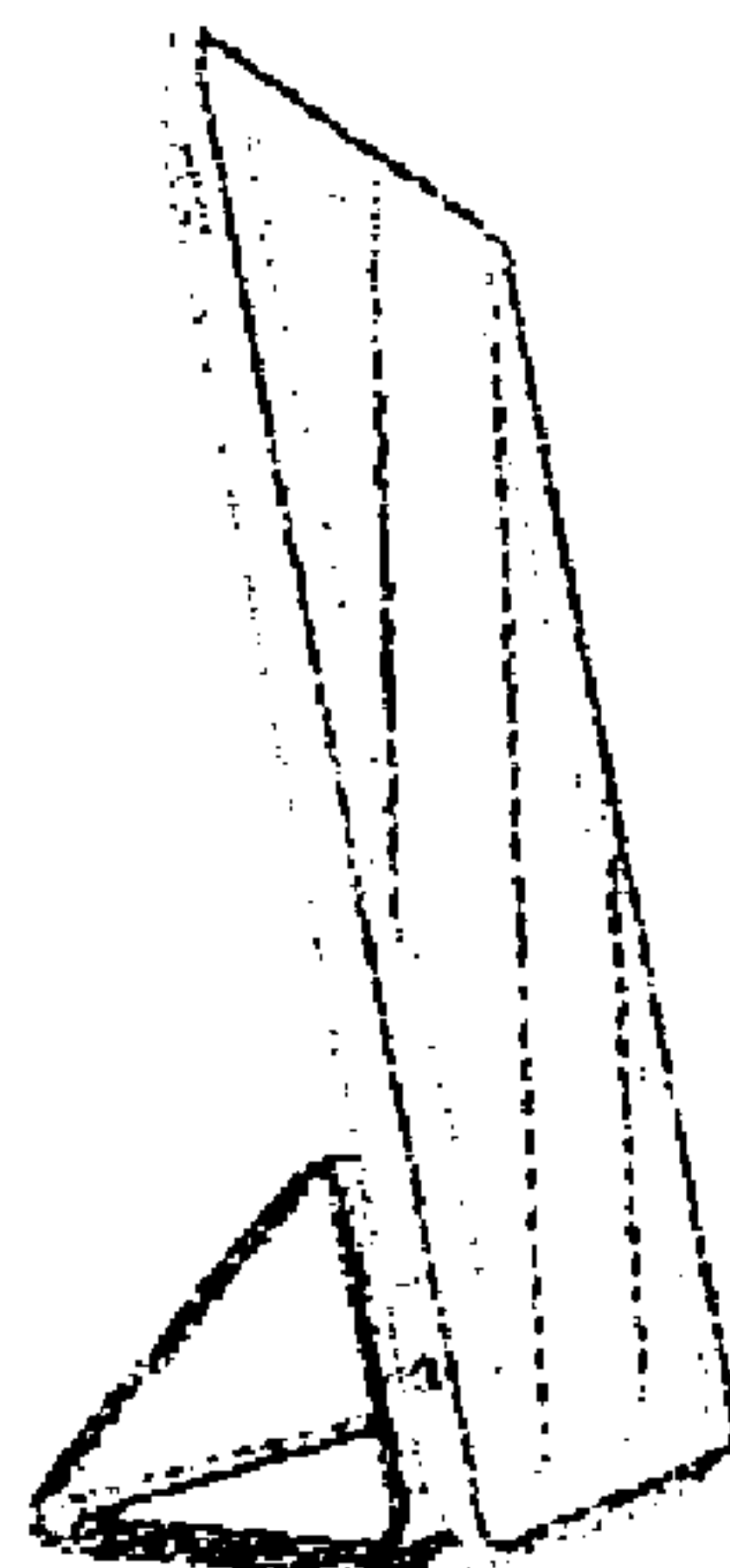

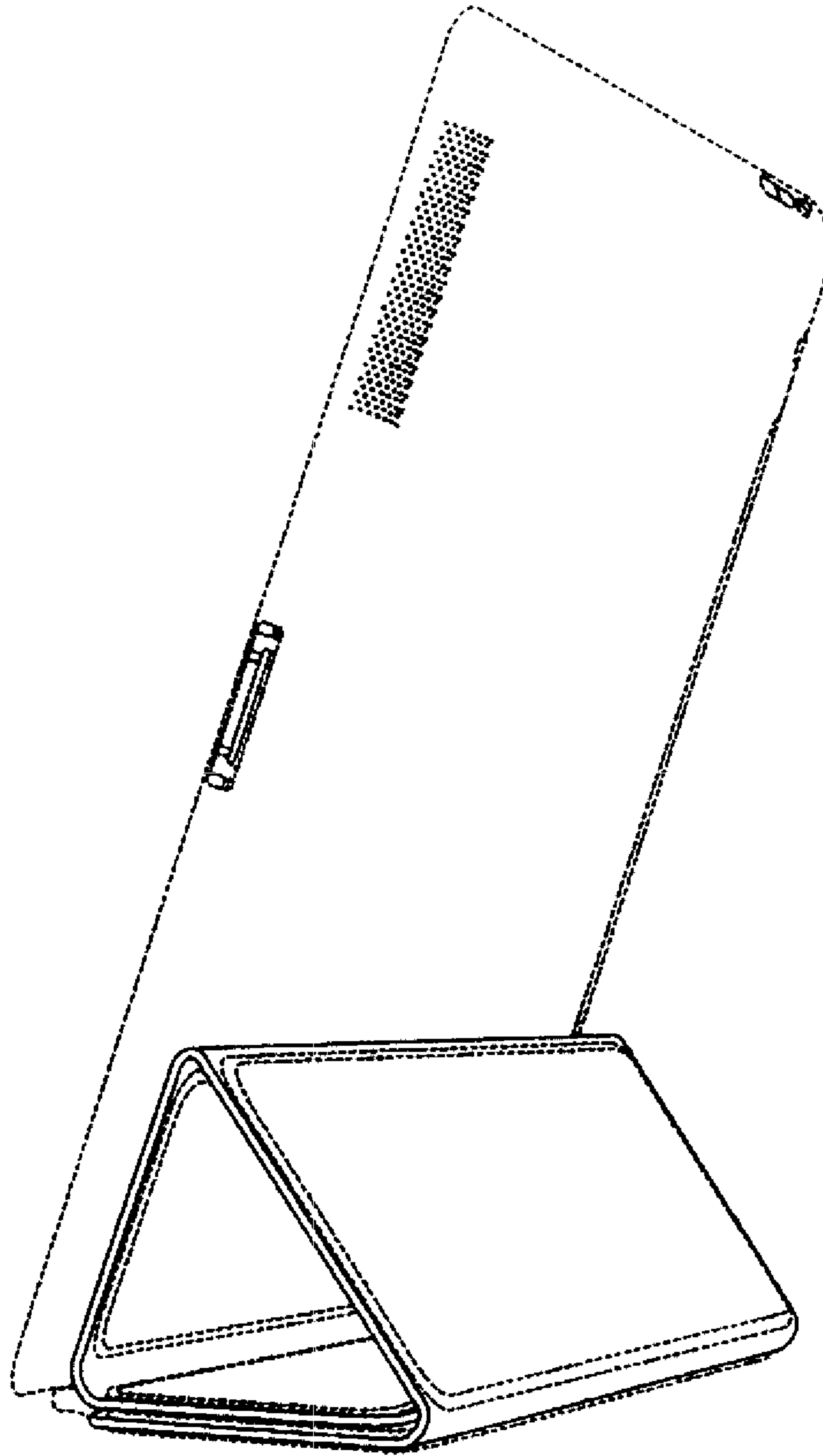

FIG. 2

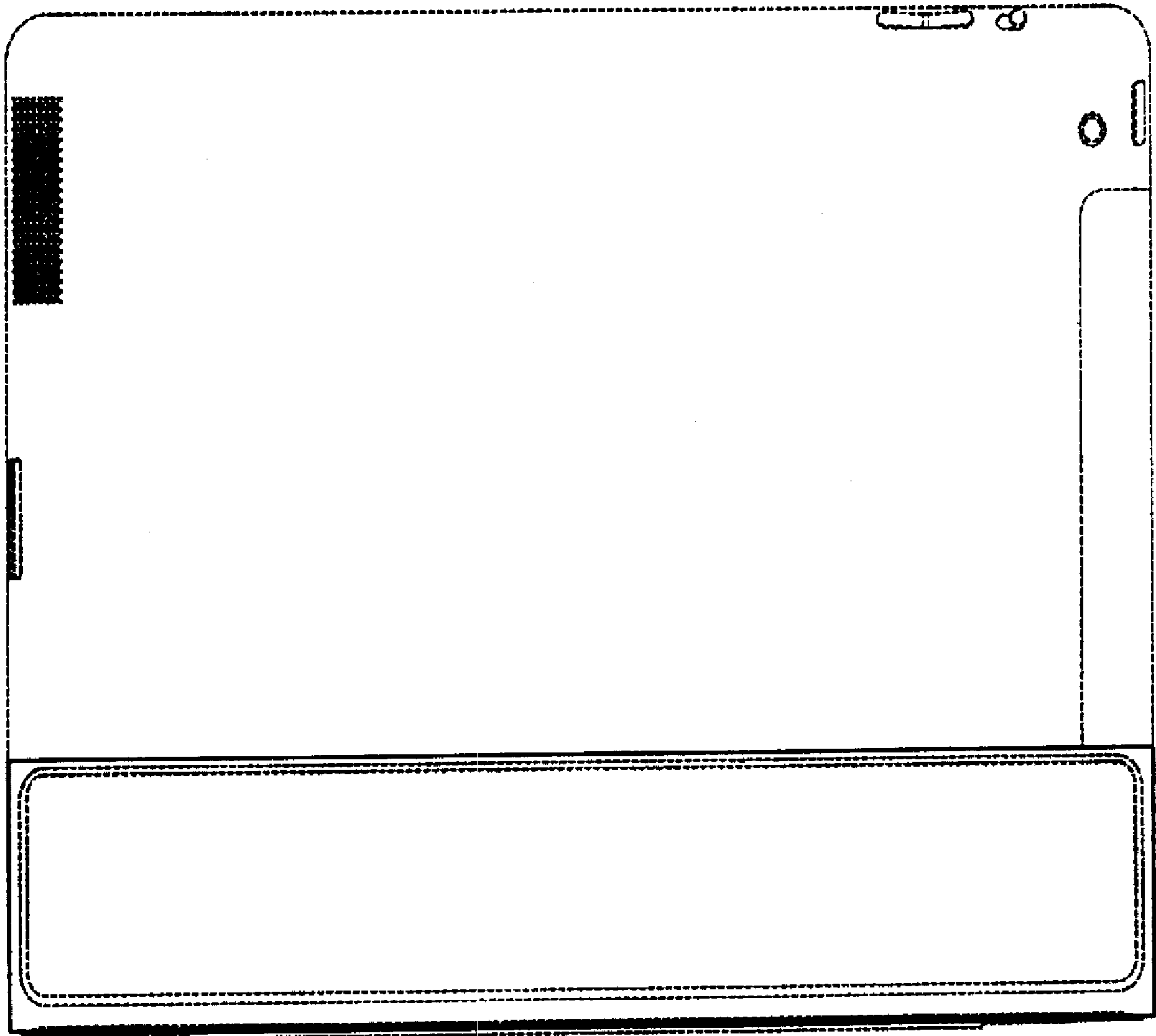

FIG. 4

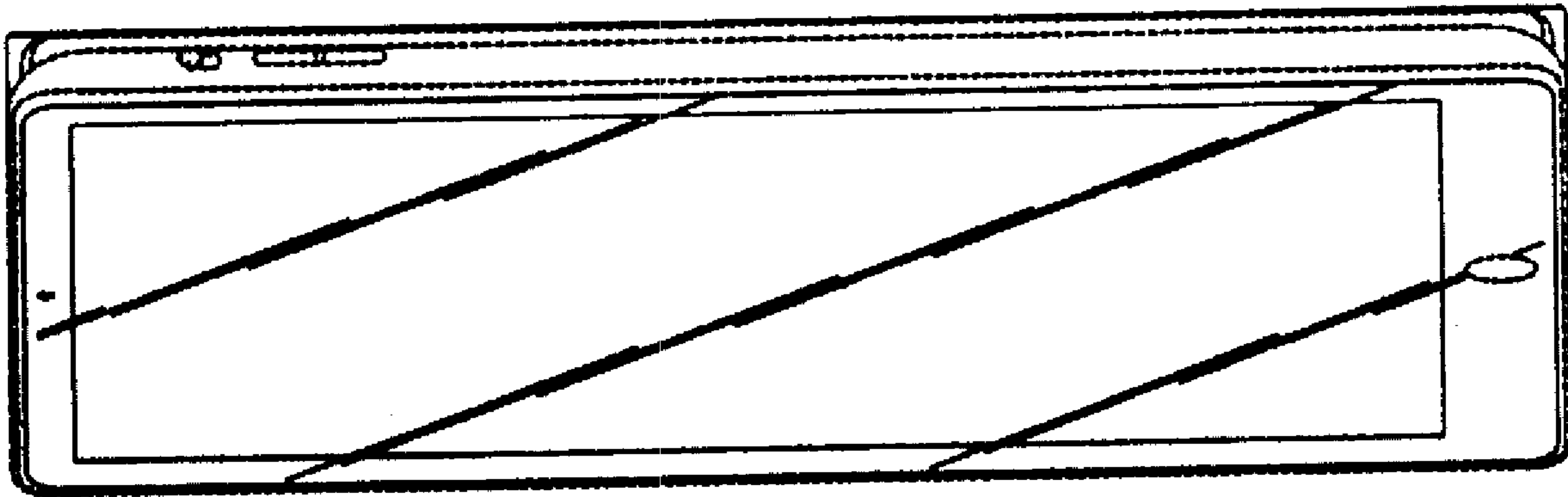

FIG. 5

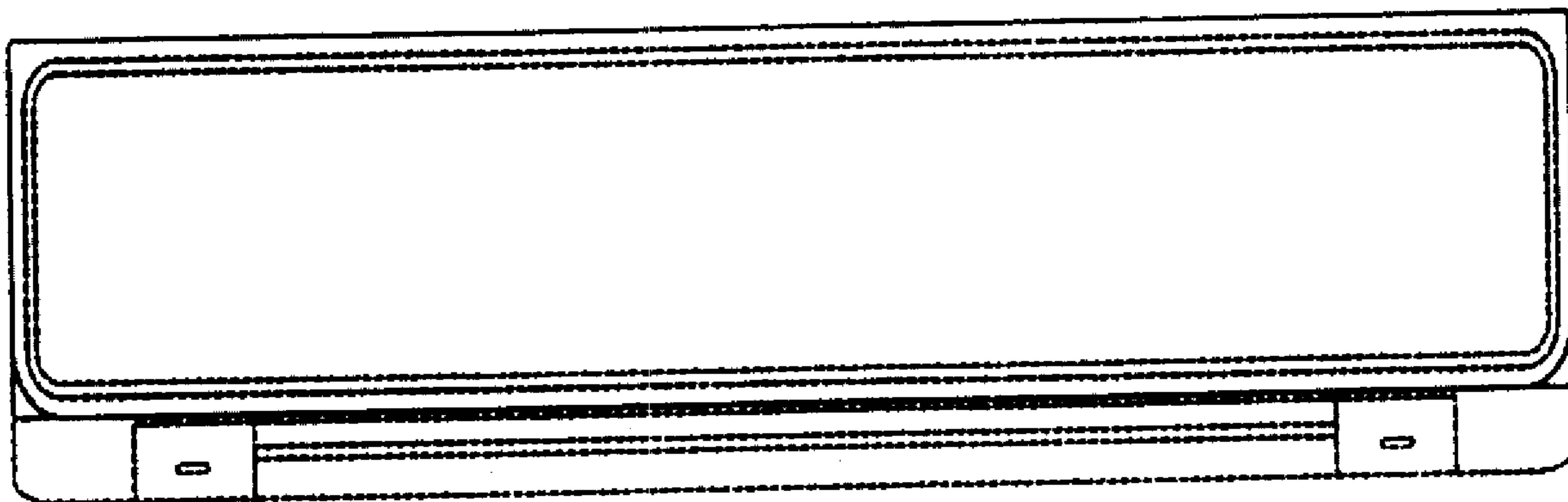

FIG. 6