



US00D704654S

(12) **United States Design Patent**  
**Smith et al.**

(10) **Patent No.:** **US D704,654 S**

(45) **Date of Patent:** **\*\* \*May 13, 2014**

(54) **ELECTRICAL CONNECTOR**

(71) Applicant: **AirBorn, Inc.**, Georgetown, TX (US)

(72) Inventors: **Jason Smith**, Houston, TX (US); **Emad Soubh**, Camas, WA (US); **John Grant**, Sherborn, MA (US)

(73) Assignee: **AirBorn, Inc.**, Georgetown, TX (US)

(\*) Notice: This patent is subject to a terminal disclaimer.

(\*\*) Term: **14 Years**

(21) Appl. No.: **29/437,279**

(22) Filed: **Nov. 14, 2012**

(51) **LOC (10) Cl.** ..... **13-03**

(52) **U.S. Cl.**  
USPC ..... **D13/147**

(58) **Field of Classification Search**  
USPC ..... D13/146, 147, 154, 184, 199;  
439/78-79, 82, 180, 246, 252, 278,  
439/350-351, 353, 357, 374, 378-379, 381,  
439/527, 529, 533, 660, 676-677, 680, 686,  
439/692, 892, 894

See application file for complete search history.

(56) **References Cited**

**U.S. PATENT DOCUMENTS**

3,002,175	A *	9/1961	Seymour et al.	439/564
D194,501	S *	2/1963	Maurer	D13/147
3,501,736	A *	3/1970	Norris	439/353
D269,673	S *	7/1983	Johansson et al.	D13/147
D272,145	S *	1/1984	Casciotti et al.	D13/147
D274,719	S *	7/1984	Casciotti et al.	D13/147
D328,595	S *	8/1992	Lou	D14/438
D330,704	S *	11/1992	Wagner	D14/242
D335,486	S *	5/1993	Fatalo	D13/147
5,273,453	A *	12/1993	Manassero et al.	439/352

5,277,596	A *	1/1994	Dixon	439/79
D372,460	S *	8/1996	Aramaki	D13/147
5,860,815	A *	1/1999	Feldman et al.	439/79
D409,573	S *	5/1999	Shimojo et al.	D13/147
D409,575	S *	5/1999	Okamoto	D13/147
D414,162	S *	9/1999	Huang	D13/147
D427,565	S *	7/2000	Lok	D13/147
D432,501	S *	10/2000	Ohtani	D13/147
6,155,887	A	12/2000	Cuff et al.	
6,220,869	B1	4/2001	Grant et al.	
6,318,632	B1	11/2001	Grant et al.	
D451,476	S *	12/2001	Wang et al.	D13/147
D458,901	S *	6/2002	Larsen et al.	D13/147
D459,310	S *	6/2002	Tanaka	D13/147
6,877,992	B2	4/2005	Grant et al.	
7,021,942	B2	4/2006	Grant et al.	
7,187,076	B2	3/2007	Cuff et al.	
D543,508	S	5/2007	Dever	
D549,659	S	8/2007	Dever	

(Continued)

*Primary Examiner* — Daniel Bui

(74) *Attorney, Agent, or Firm* — Locke Lord LLP

(57) **CLAIM**

The ornamental design for an electrical connector, as shown and described.

**DESCRIPTION**

FIG. 1 is a top perspective view of an electrical connector showing our new design;

FIG. 2 is a front elevation view thereof;

FIG. 3 is a back elevation view thereof;

FIG. 4 is a left side elevation view thereof;

FIG. 5 is a right side elevation view thereof;

FIG. 6 is a top elevation view thereof;

FIG. 7 is a bottom elevation view thereof; and,

FIG. 8 is a bottom perspective view thereof.

The broken line in the figure drawing views is included for the purpose of illustrating unclaimed environment only and forms no part of the claim designed.

**1 Claim, 5 Drawing Sheets**

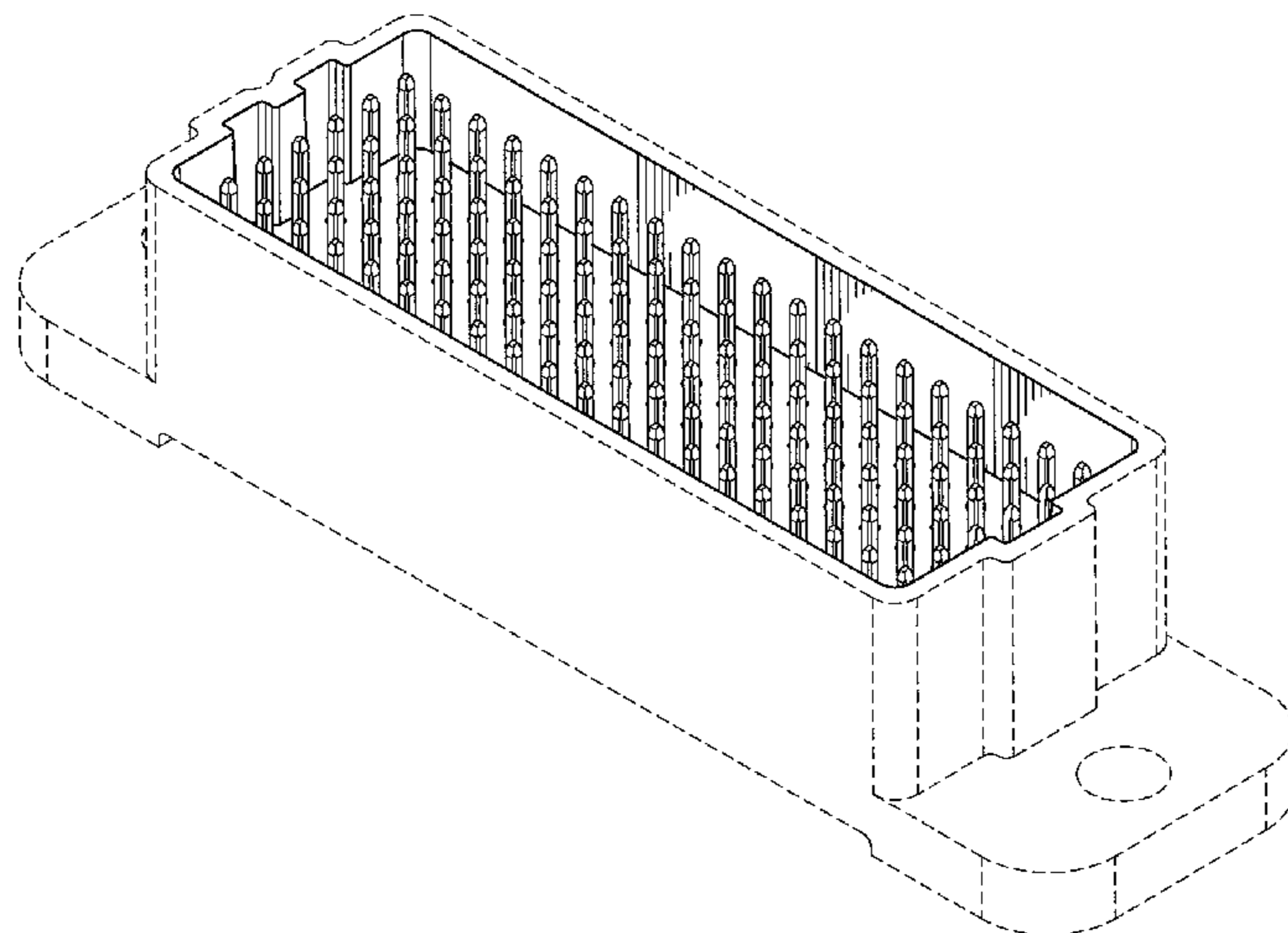

(56)

**References Cited**

U.S. PATENT DOCUMENTS

D560,613 S 1/2008 McEvoy et al.  
D560,614 S 1/2008 McEvoy et al.  
D561,103 S 2/2008 Grant  
D561,107 S 2/2008 Cuff et al.  
D561,108 S 2/2008 Cuff et al.  
D561,109 S 2/2008 Howerton et al.  
D561,110 S 2/2008 Howerton et al.  
D561,698 S 2/2008 Cuff et al.  
D562,248 S 2/2008 Howerton et al.  
D562,249 S 2/2008 Howerton et al.

D562,775 S 2/2008 Cuff et al.  
D563,877 S 3/2008 Grant  
D563,878 S 3/2008 Grant  
D563,879 S 3/2008 Grant  
D563,880 S 3/2008 Grant  
D563,881 S 3/2008 Howerton et al.  
D563,882 S 3/2008 Howerton et al.  
D563,883 S 3/2008 Dever  
D563,884 S 3/2008 Dever  
D563,885 S 3/2008 Dever  
D563,886 S 3/2008 Dever  
D563,887 S 3/2008 Dever

\* cited by examiner

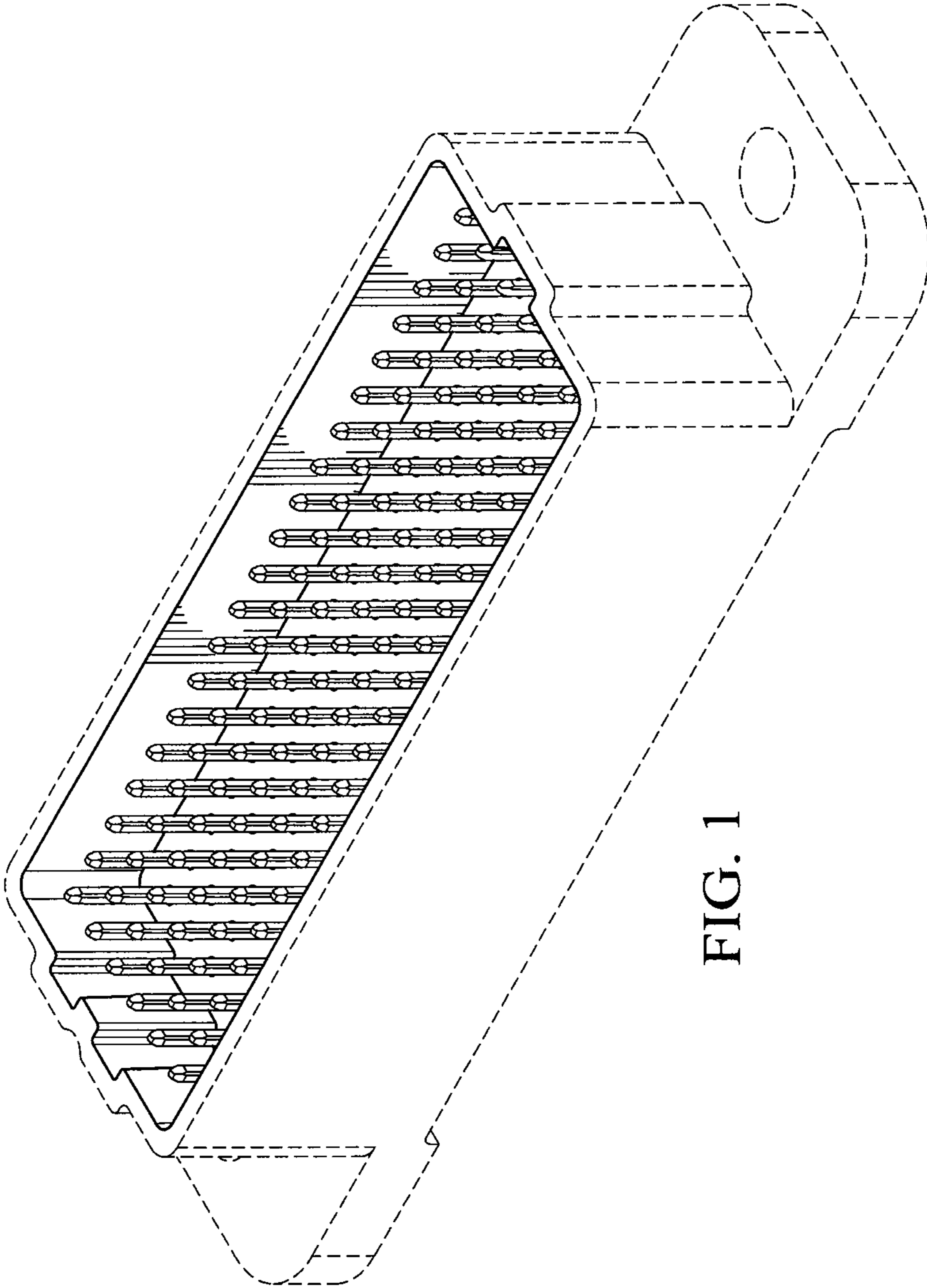

FIG. 1

FIG. 2

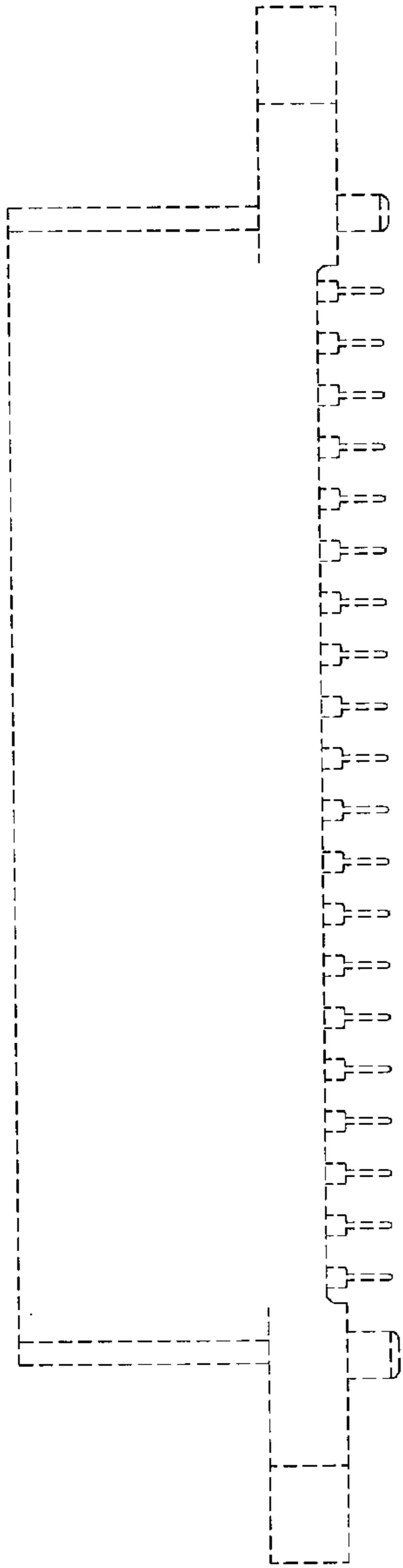

FIG. 3

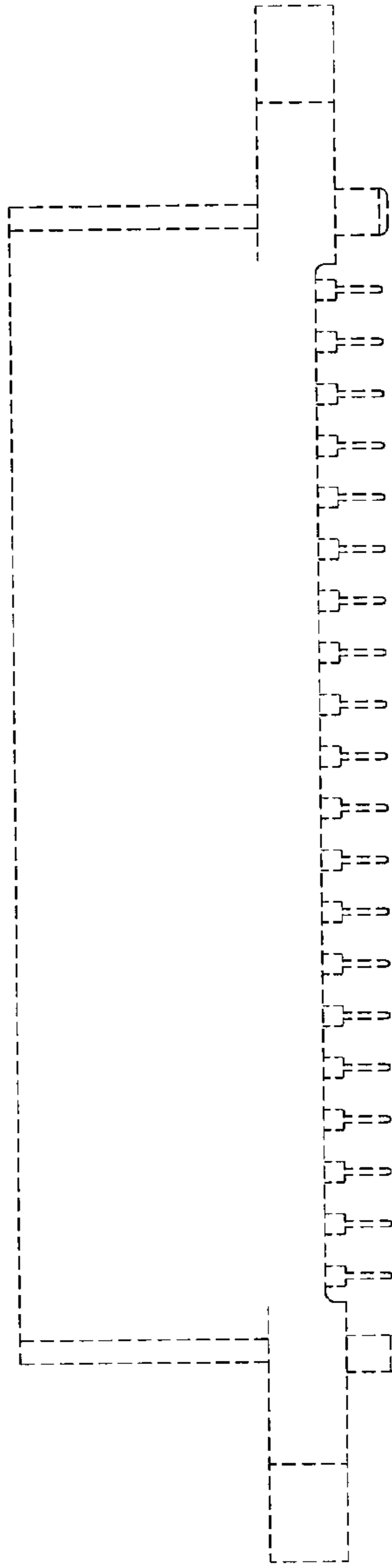

FIG. 5

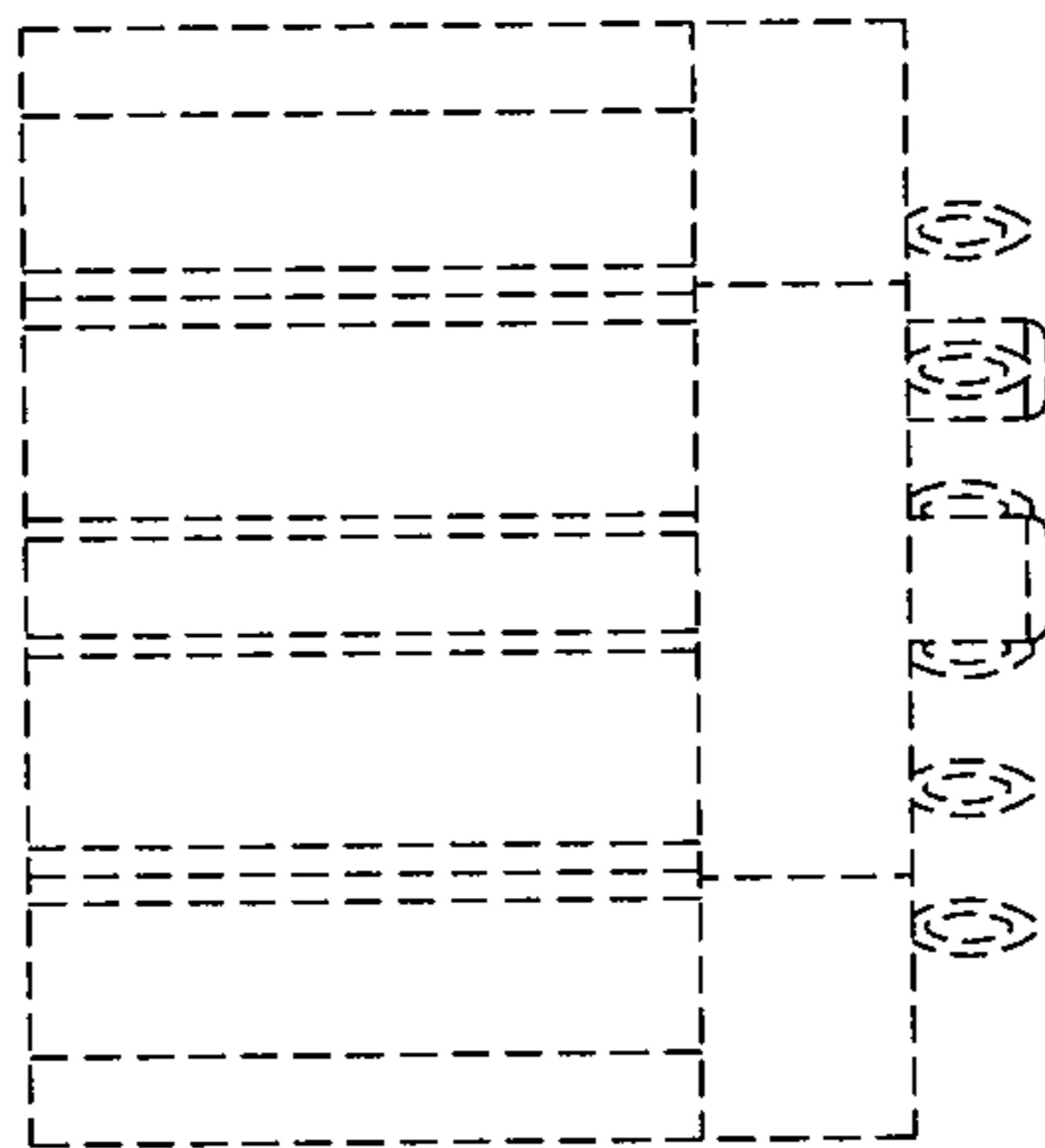

FIG. 4

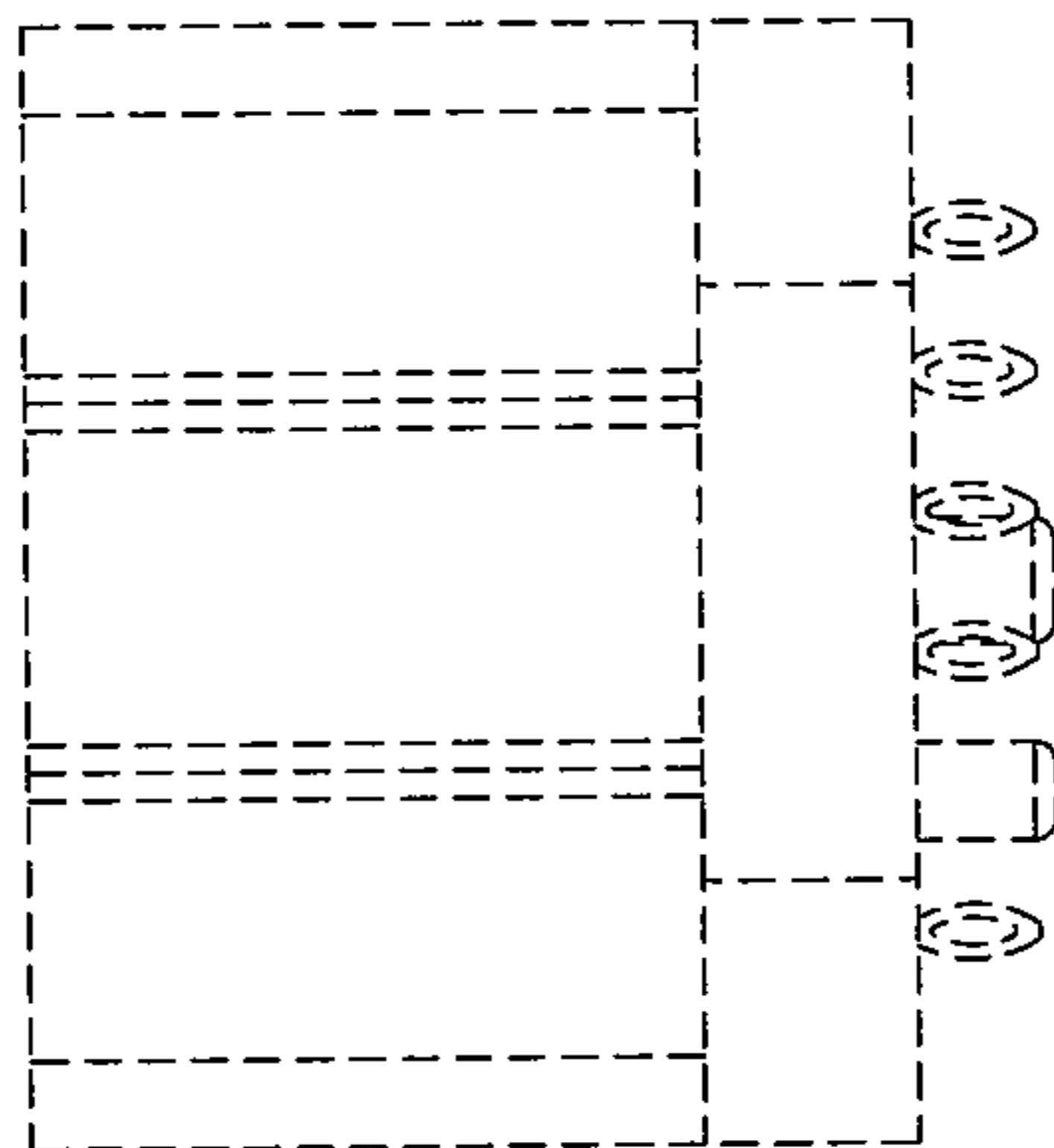

FIG. 6

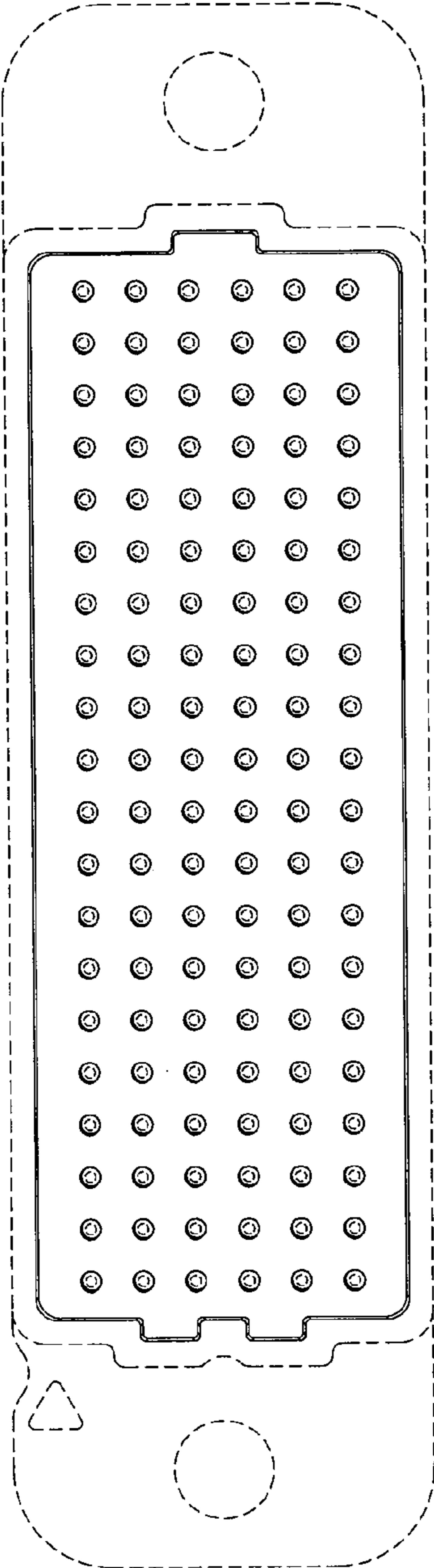
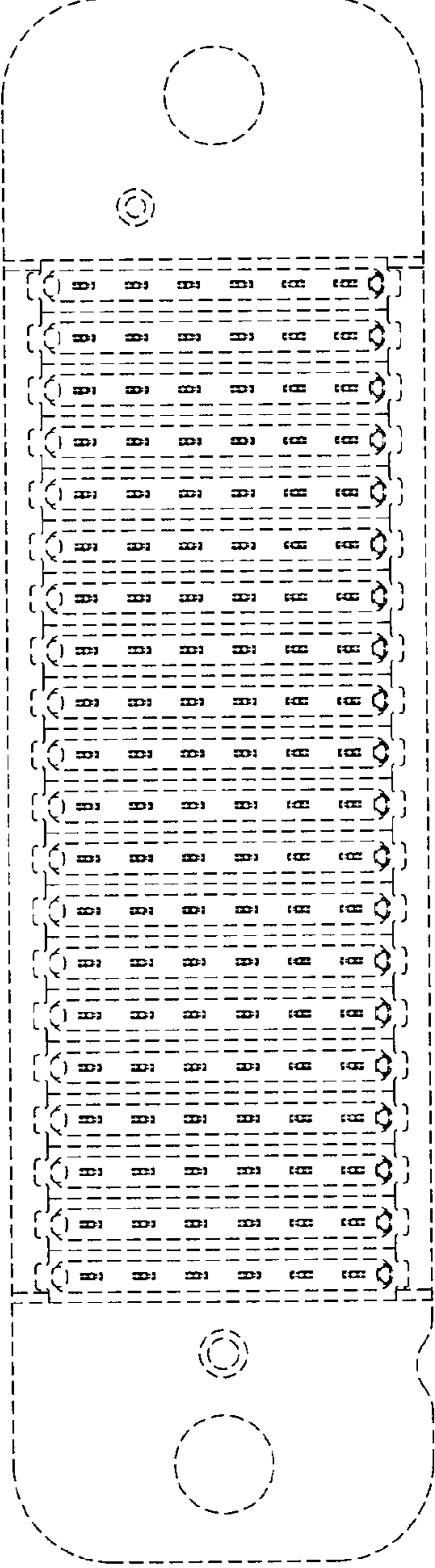

FIG. 7



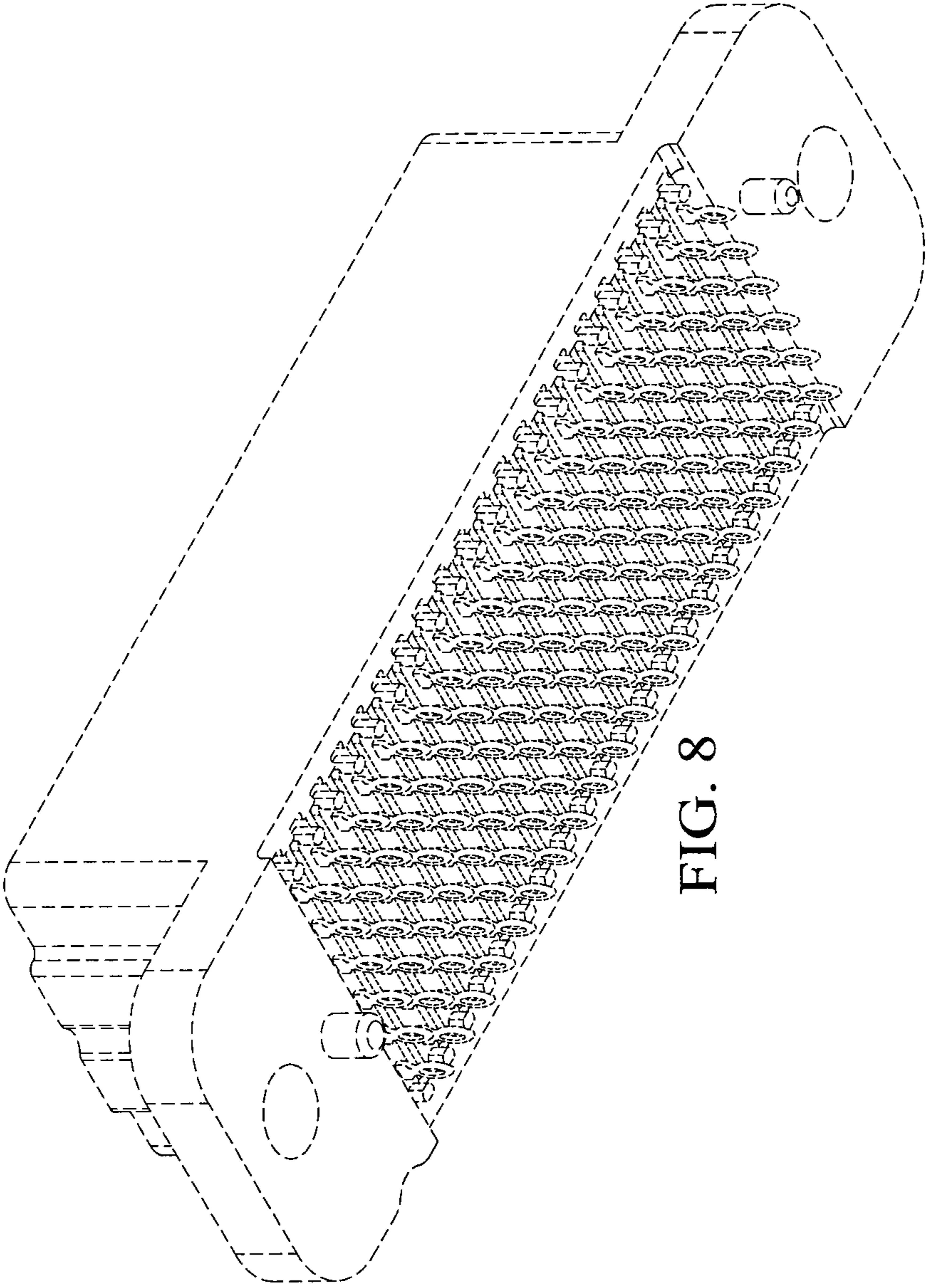

FIG. 8