



US00D704585S

(12) **United States Design Patent**
Kuo

(10) **Patent No.:** **US D704,585 S**

(45) **Date of Patent:** **** May 13, 2014**

(54) **PORTION OF A TRAFFIC CONE**

(71) Applicant: **Wen-Nan Kuo**, Kaohsiung (TW)

(72) Inventor: **Wen-Nan Kuo**, Kaohsiung (TW)

(**) Term: **14 Years**

(21) Appl. No.: **29/451,820**

(22) Filed: **Apr. 9, 2013**

(51) **LOC (10) Cl.** **10-05**

(52) **U.S. Cl.**
USPC **D10/113.2**

(58) **Field of Classification Search**
USPC D10/109, 113.1–113.4; 116/63 R;
404/9–16; 340/908.1; D3/273;
362/249.02

See application file for complete search history.

(56) **References Cited**

U.S. PATENT DOCUMENTS

- 5,195,453 A * 3/1993 McGibbon, II 116/63 C
- 5,294,924 A * 3/1994 Dydzyk 340/908.1
- D435,724 S * 1/2001 Huang D3/273
- 7,997,764 B1 * 8/2011 Nielson 362/249.02

* cited by examiner

Primary Examiner — George D Kirschbaum

(74) *Attorney, Agent, or Firm* — C. G. Mersereau; Nikolai & Mersereau, P.A.

(57) **CLAIM**

The ornamental design for a portion of a traffic cone, as shown and described.

DESCRIPTION

FIG. 1 is a top perspective view of a portion of a traffic cone, showing my new design;
 FIG. 2 is a front view thereof;
 FIG. 3 is a rear view thereof;
 FIG. 4 is a left view thereof;
 FIG. 5 is a right view thereof;
 FIG. 6 is a top view thereof;
 FIG. 7 is a bottom view thereof;
 FIG. 8 is a bottom perspective view thereof;
 FIG. 9 is an enlarged perspective view of the portion of the traffic cone of FIG. 1;
 FIG. 10 is an enlarged plan view of the portion of the traffic cone of FIG. 1;
 FIG. 11 is another enlarged perspective view of the portion of the traffic cone of FIG. 1; and,
 FIG. 12 is an enlarged perspective view of a part of the portion of a traffic cone of FIG. 11.
 The broken lines are for illustrative purposes only and form no part of the claimed design.

1 Claim, 11 Drawing Sheets

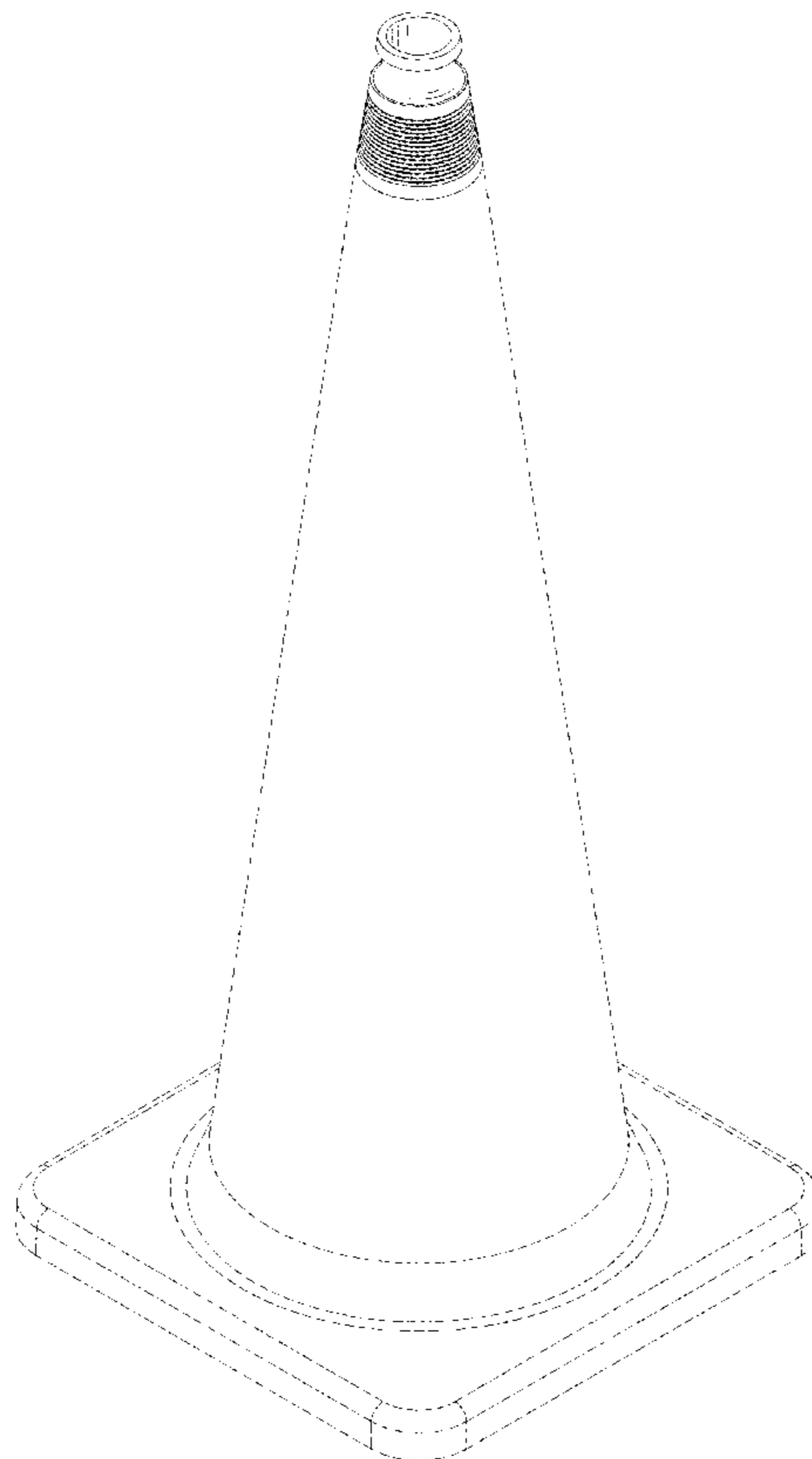

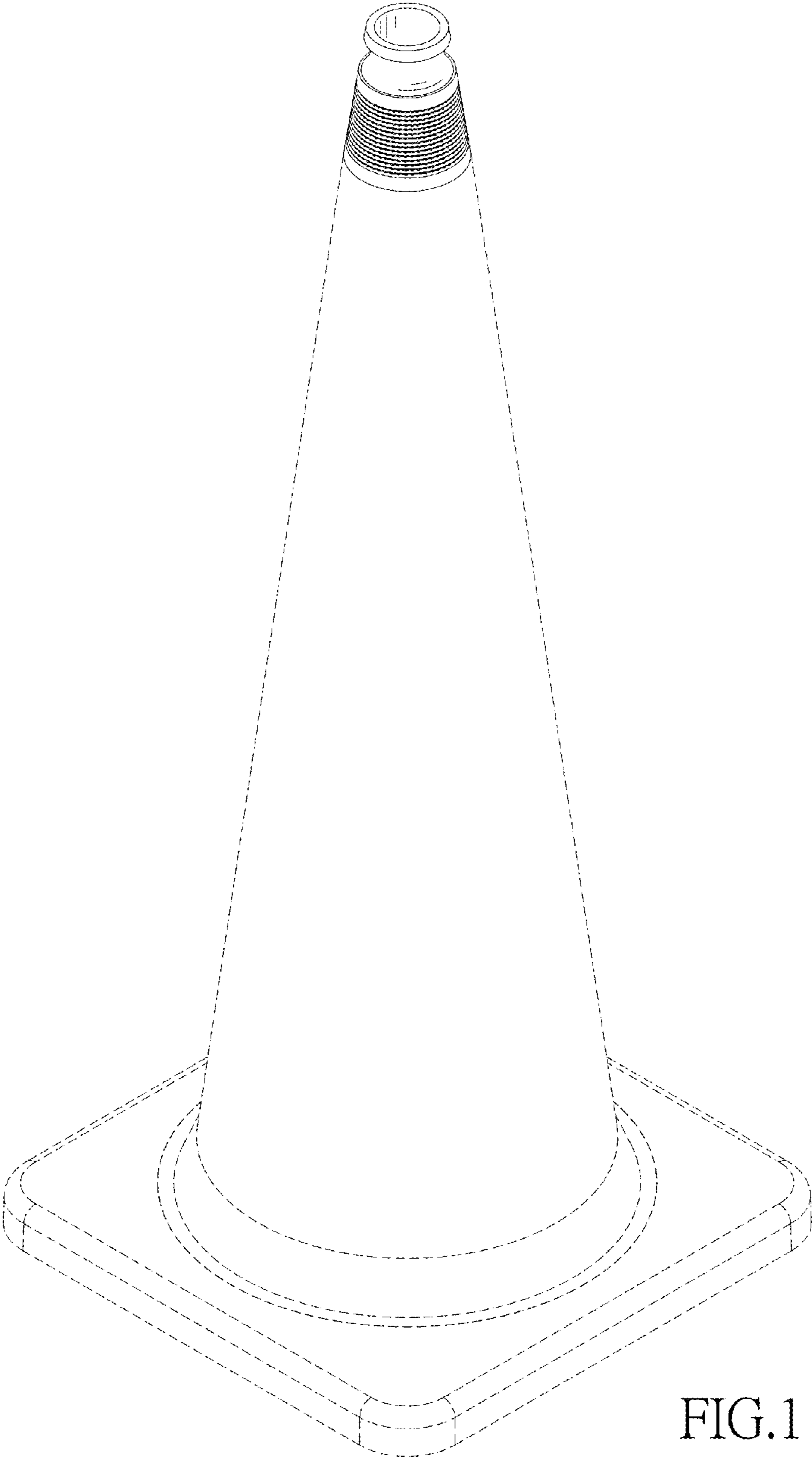

FIG. 1

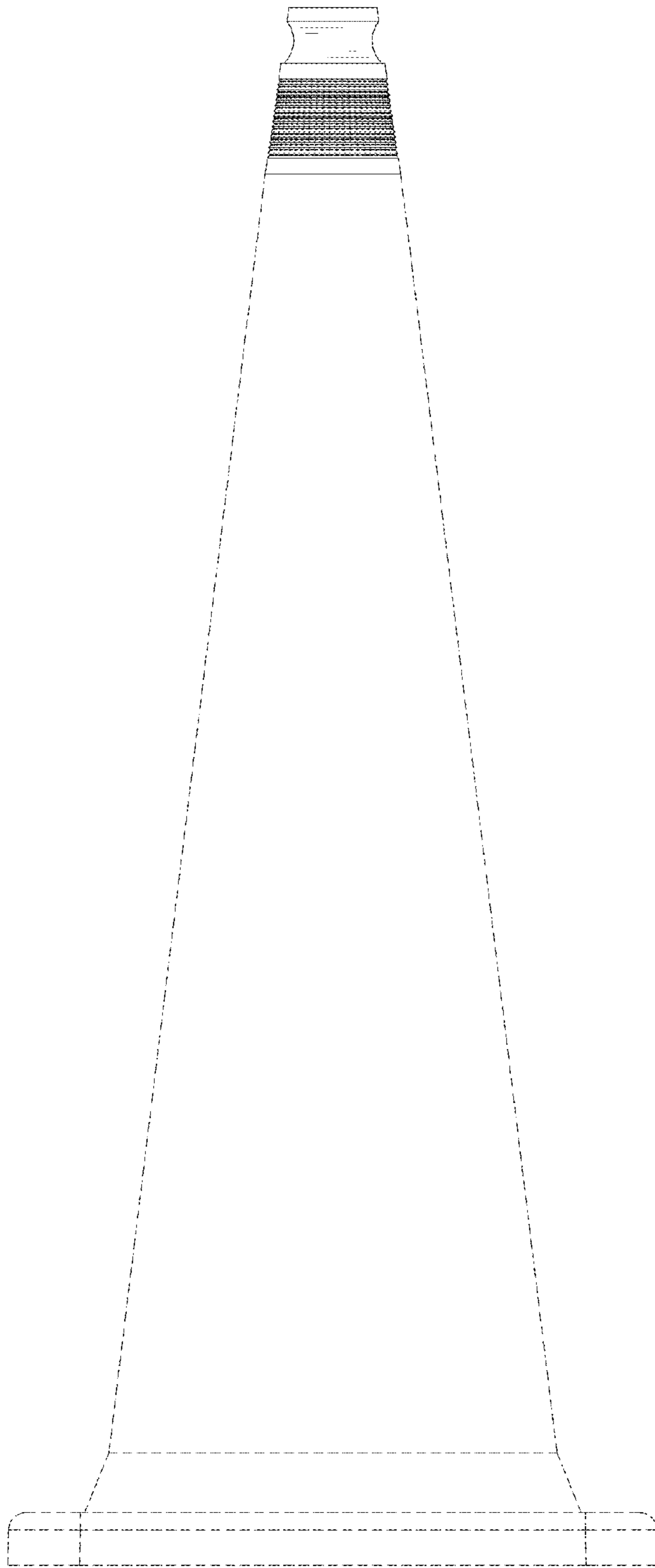

FIG.2

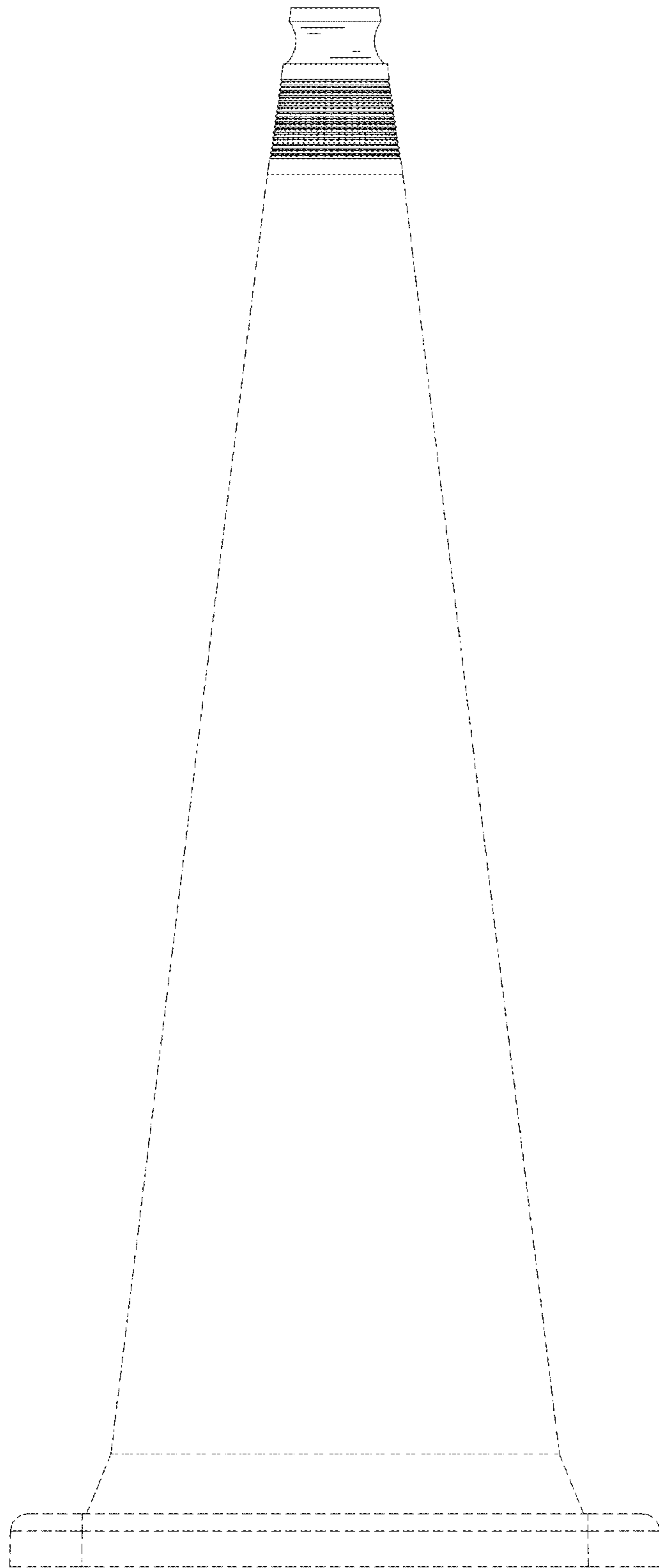

FIG.3

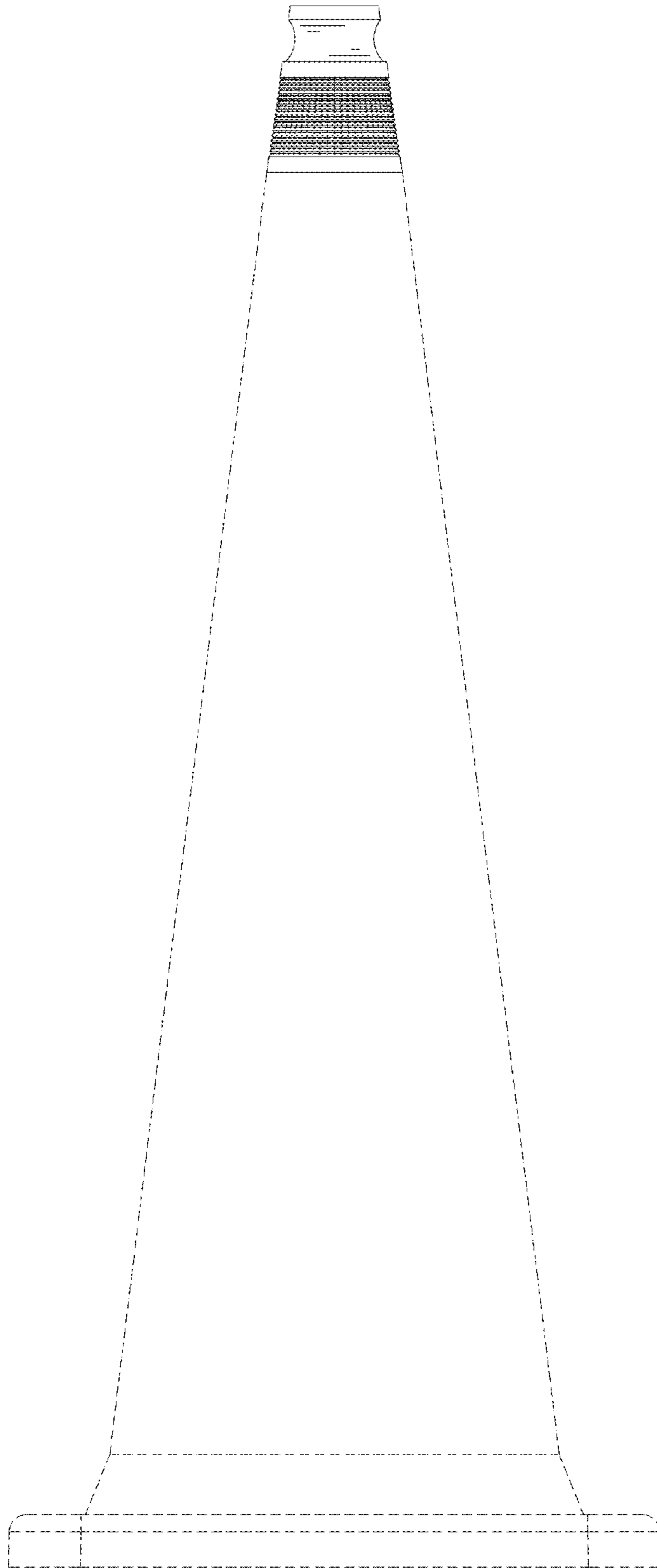

FIG.4

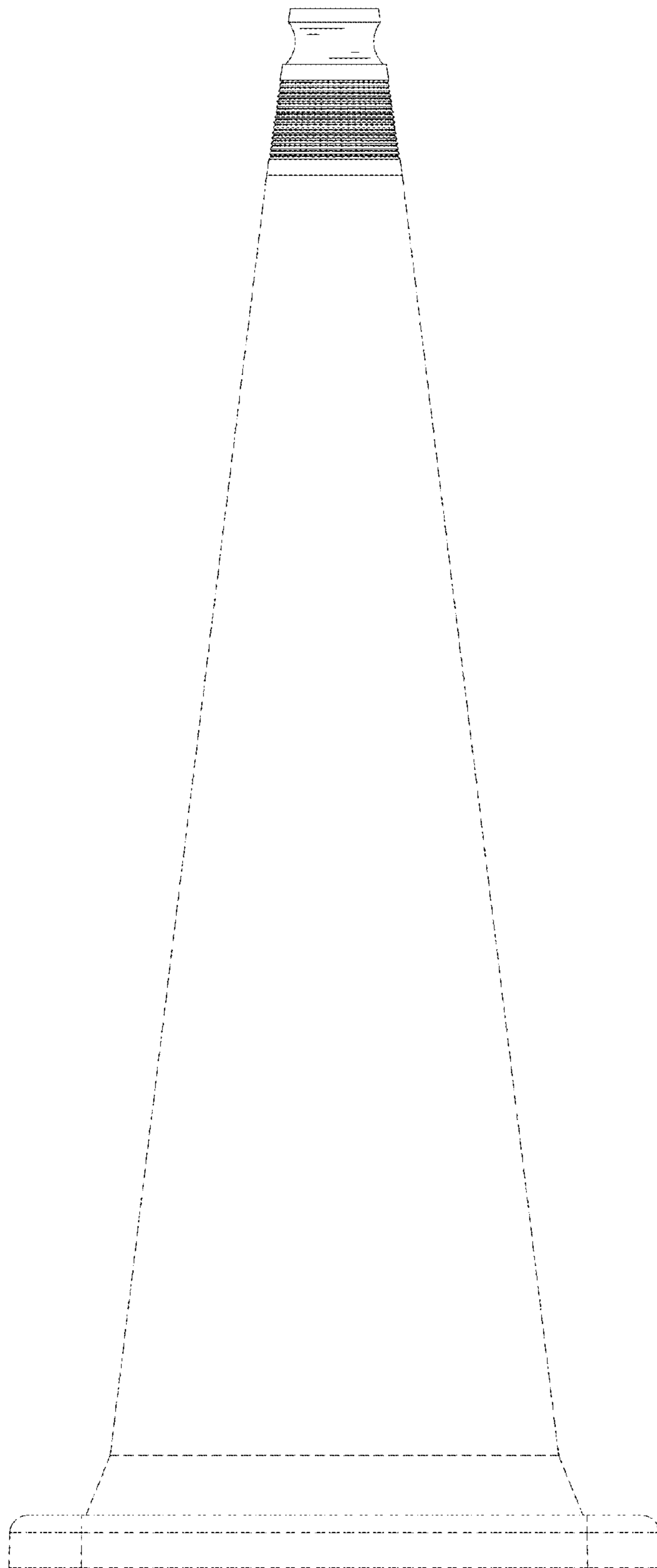

FIG.5

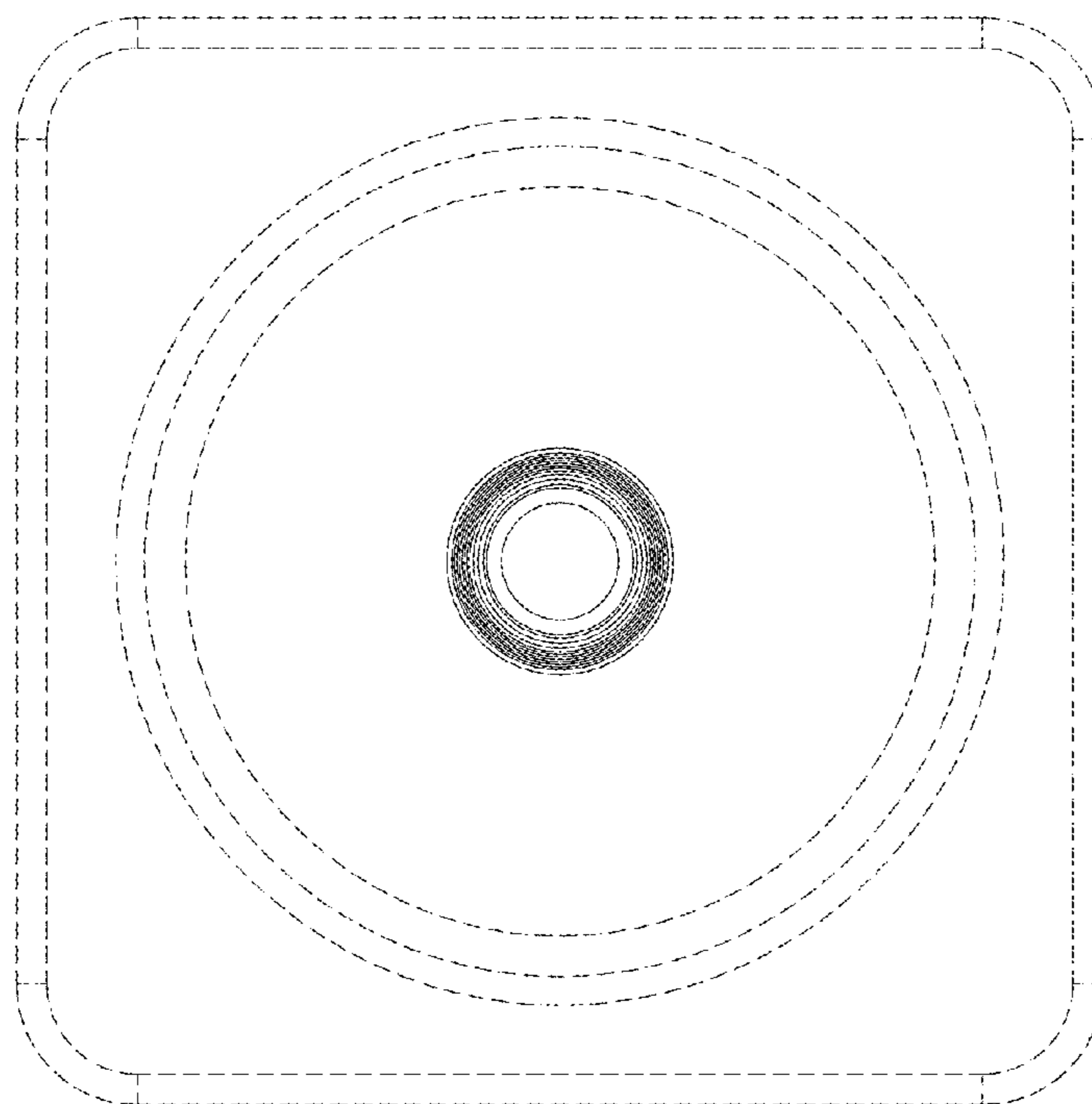

FIG. 6

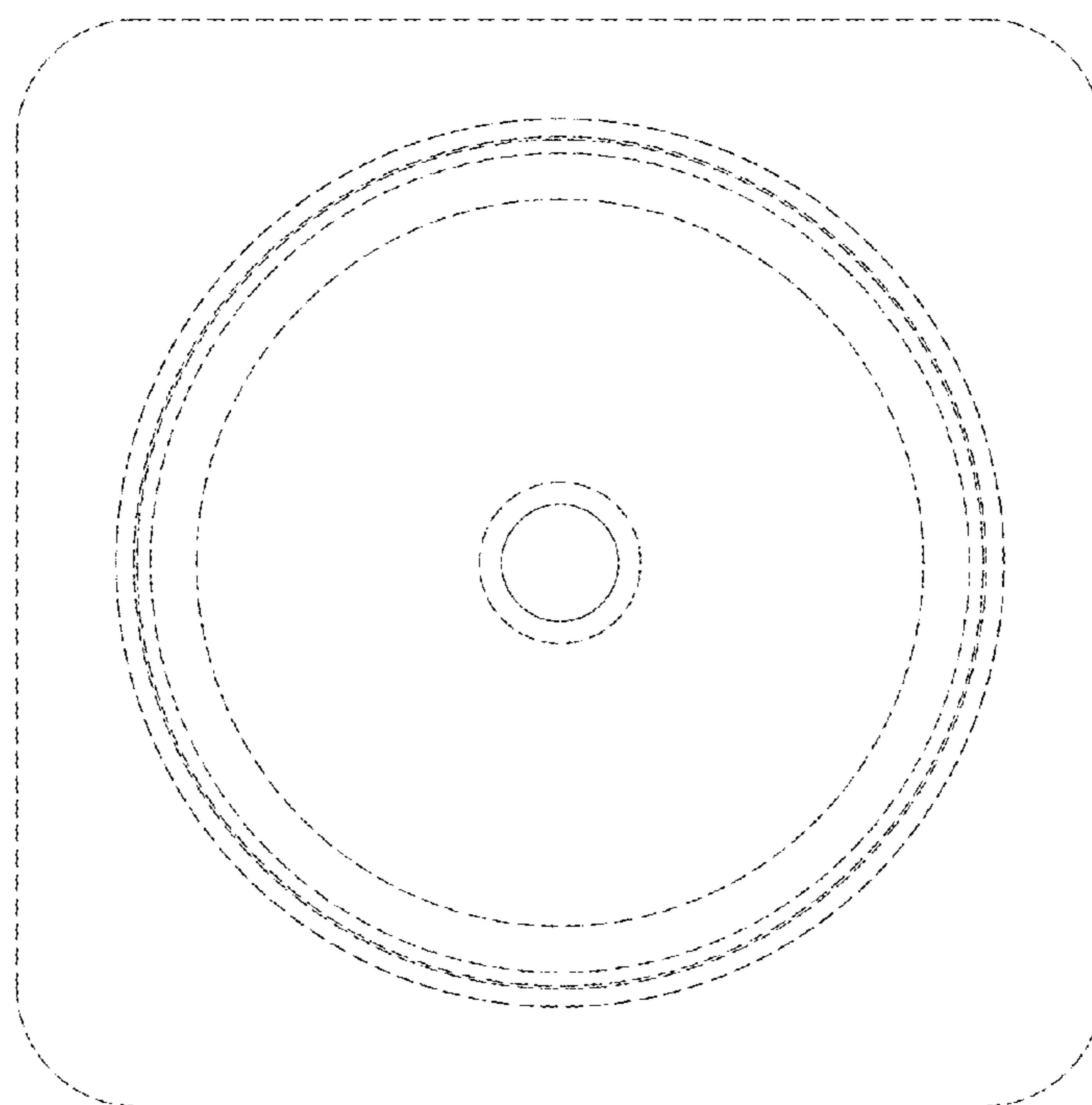

FIG. 7

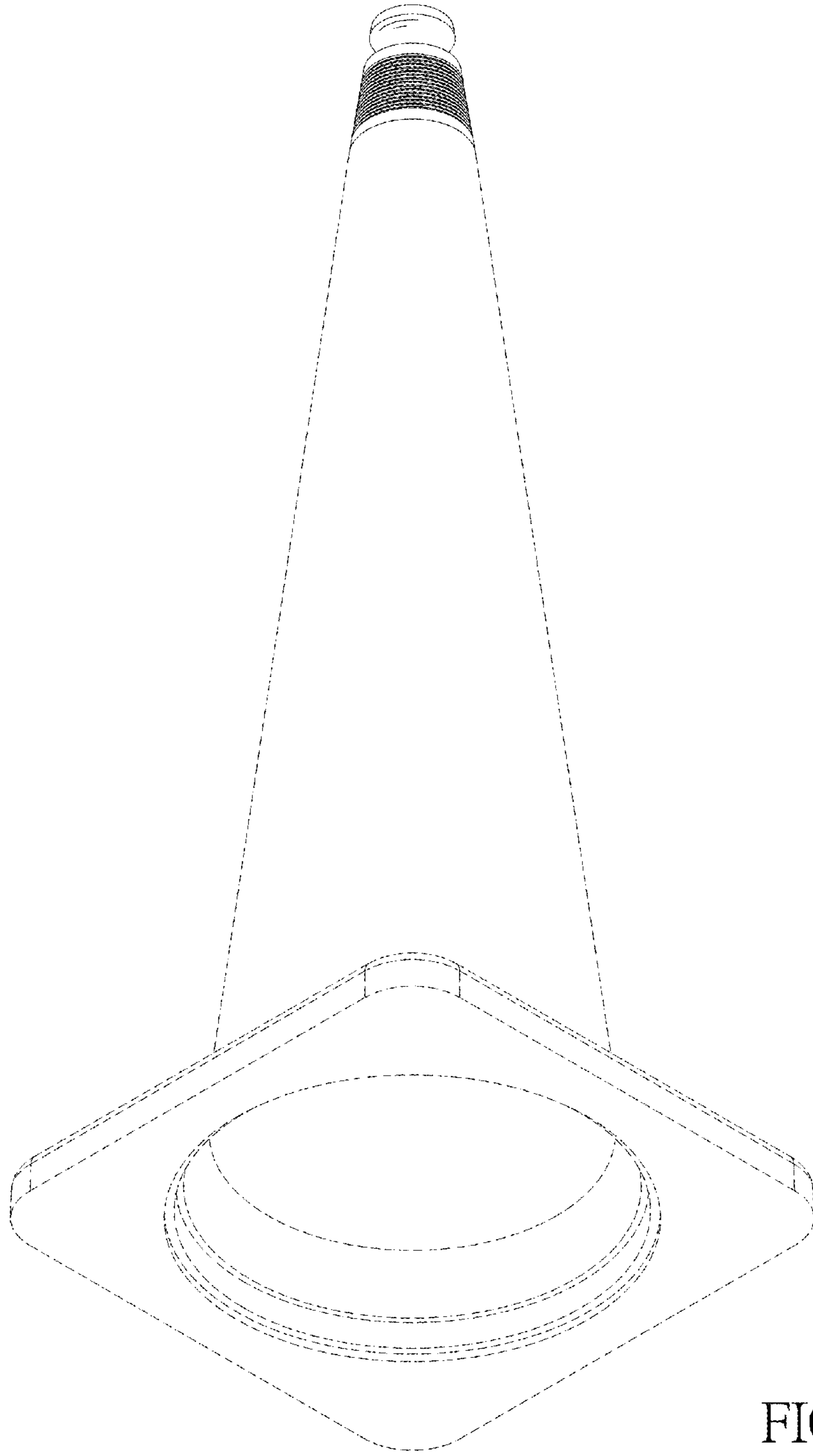

FIG.8

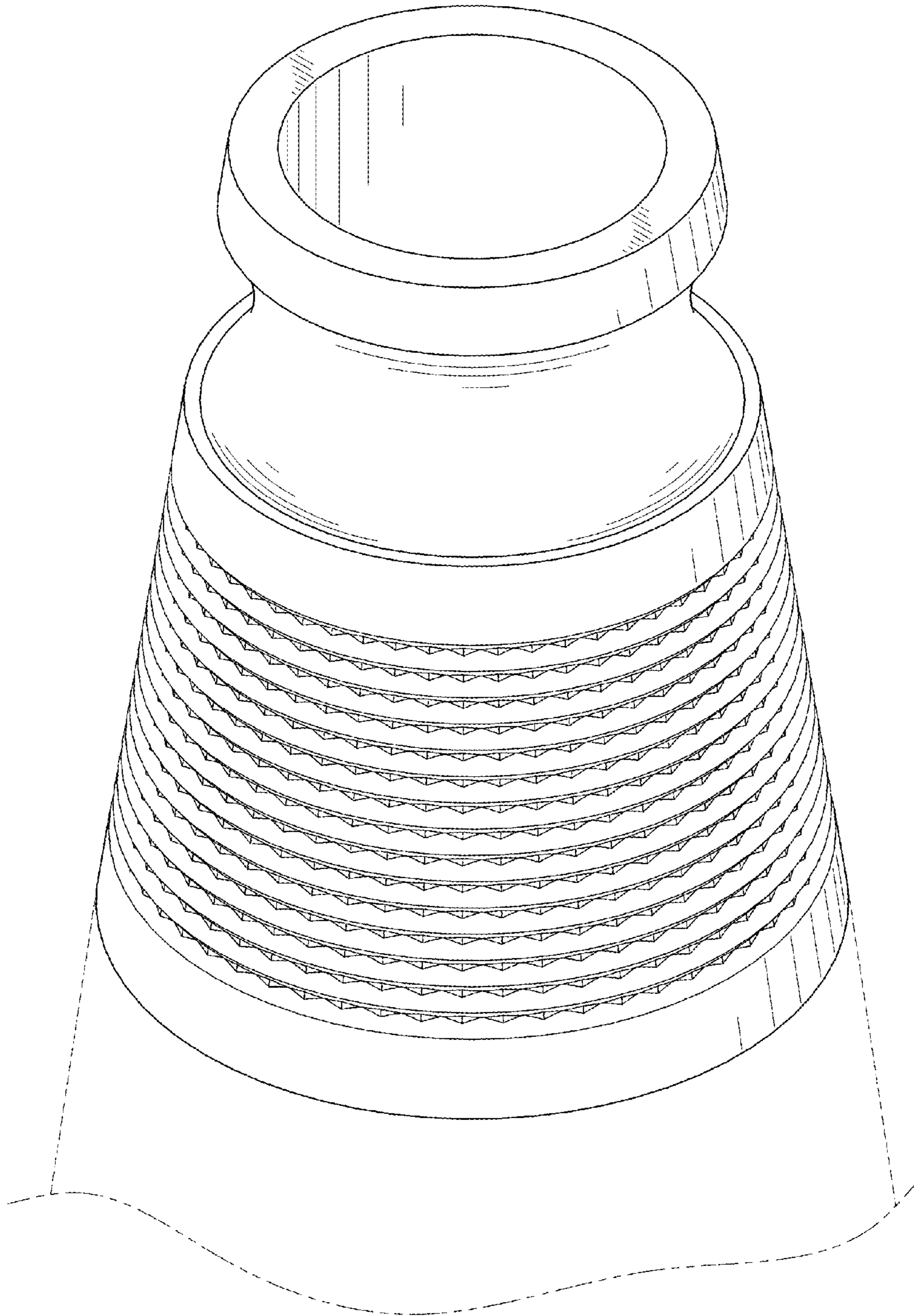

FIG. 9

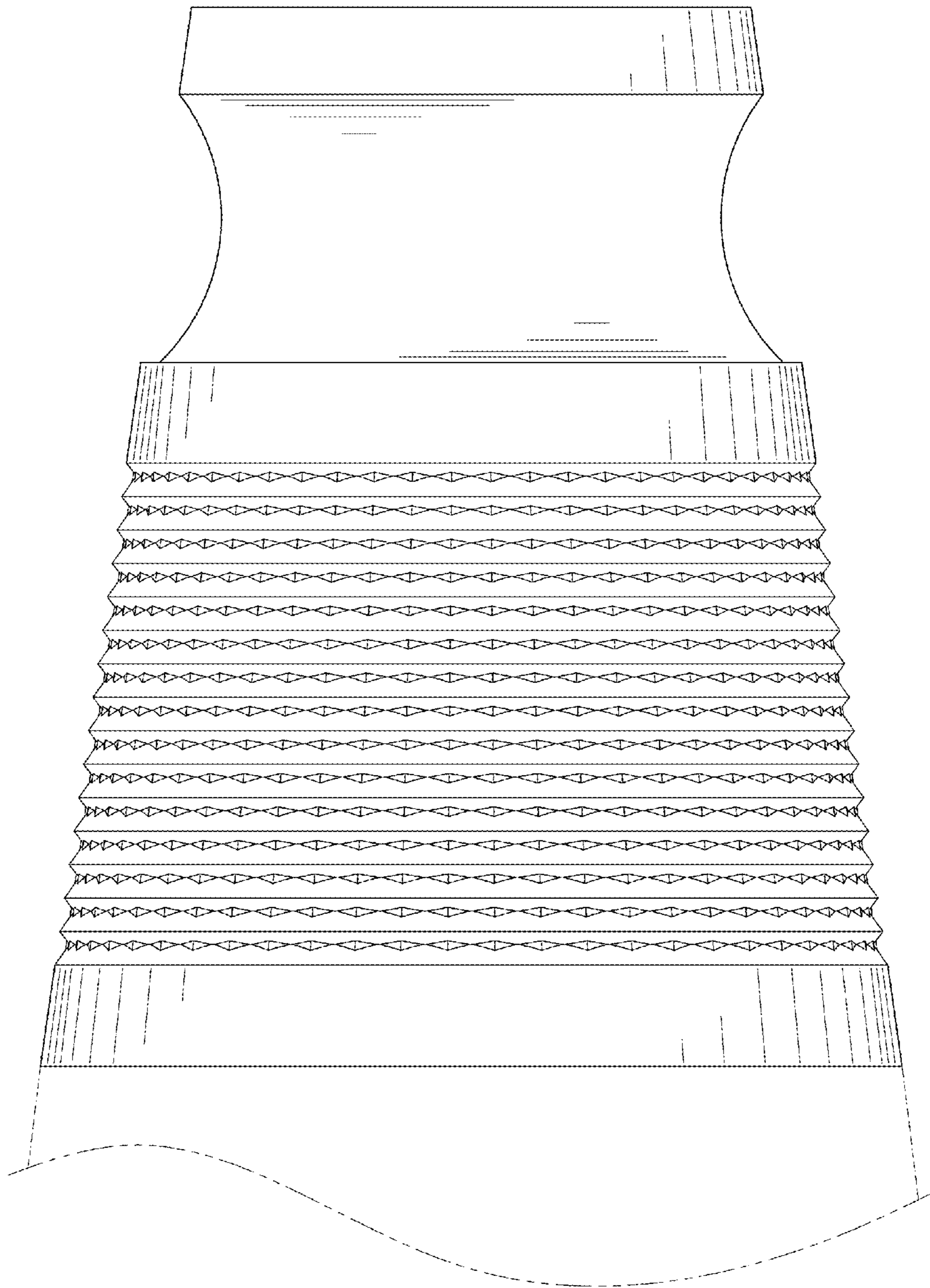

FIG.10

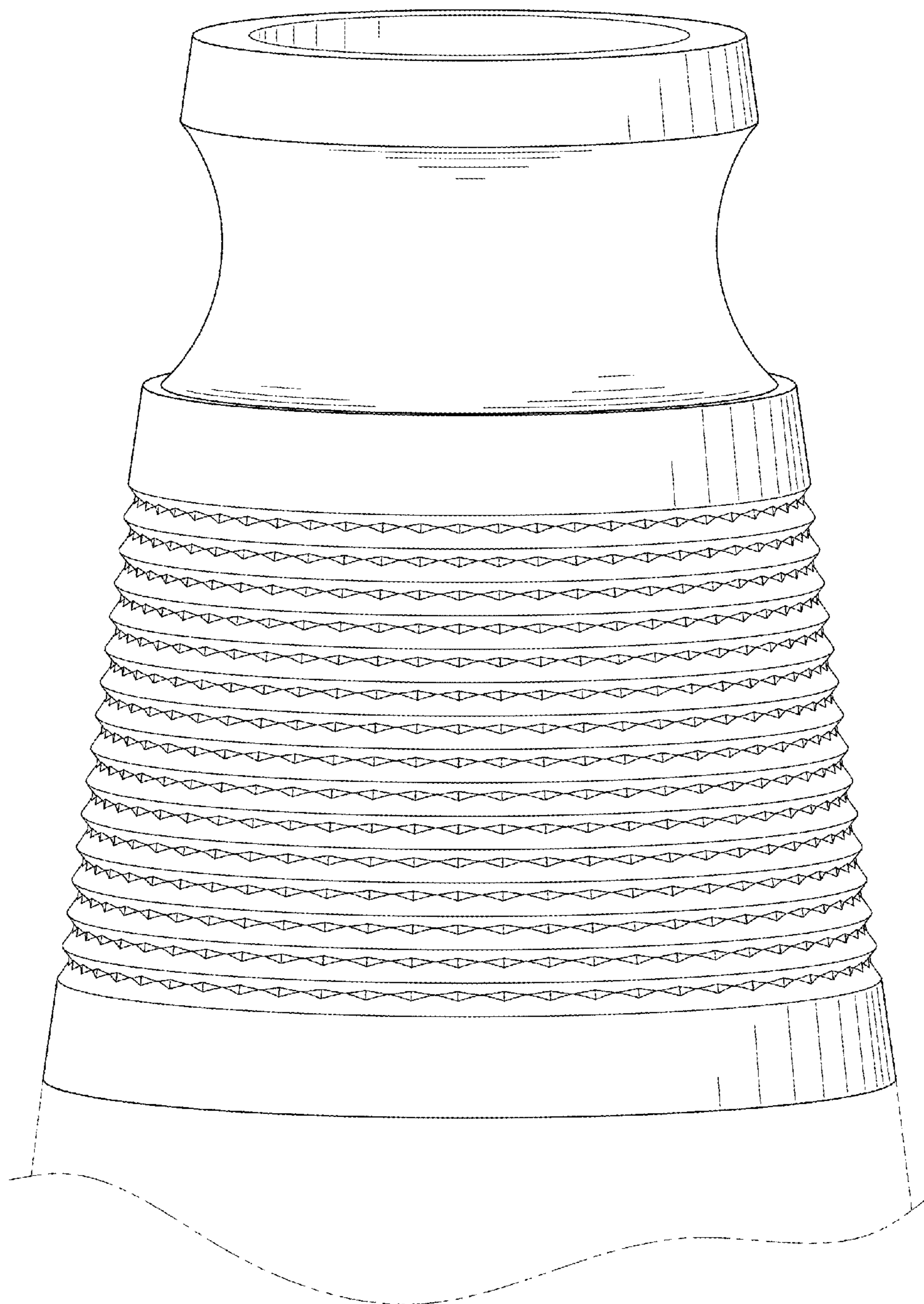

FIG.11

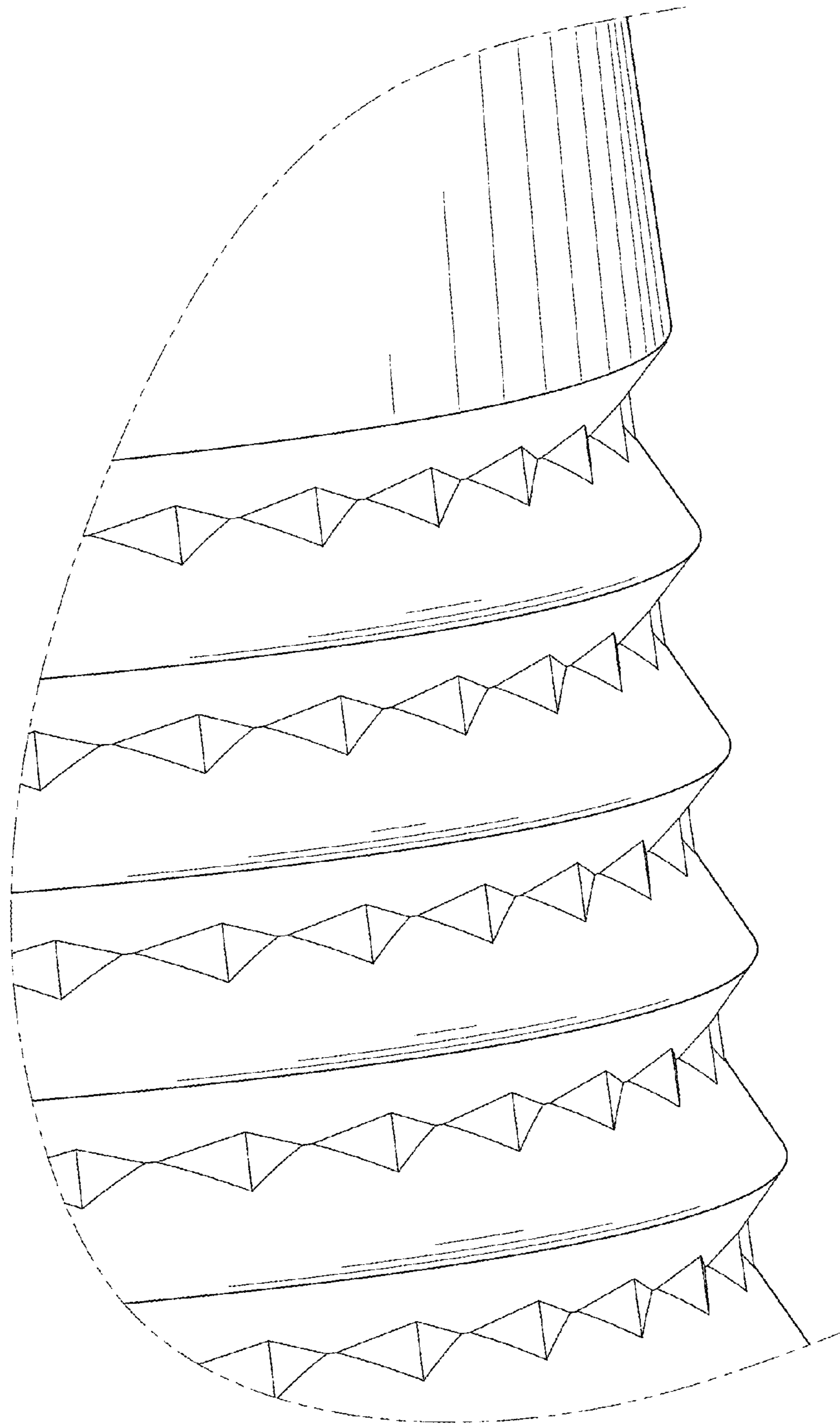

FIG. 12