



US00D704553S

(12) **United States Design Patent**  
**Cassens et al.**

(10) **Patent No.:** **US D704,553 S**

(45) **Date of Patent:** **\*\* May 13, 2014**

(54) **PACKAGING FOR FOOD PRODUCT**

(75) Inventors: **Martha E. Cassens**, Chicago, IL (US);  
**Stuart M. Leslie**, Larchmont, NY (US);  
**Jason C. Billig**, Mount Vernon, NY  
(US); **Thomas Anthony Lucio**, Bronx,  
NY (US)

(73) Assignee: **The Hillshire Brands Company**,  
Chicago, IL (US)

(\*\*) Term: **14 Years**

(21) Appl. No.: **29/431,711**

(22) Filed: **Sep. 10, 2012**

(51) **LOC (10) Cl.** ..... **09-07**

(52) **U.S. Cl.**  
USPC ..... **D9/434**

(58) **Field of Classification Search**  
CPC ..... B65D 29/02; B65D 85/804; B65D 1/22;  
B65D 85/8043; B65D 1/42  
USPC ..... D9/424-429, 434, 415, 418, 629, 414,  
D9/431, 756, 759; 206/461-471; D7/396.1  
See application file for complete search history.

(56) **References Cited**

U.S. PATENT DOCUMENTS

3,522,877 A	8/1970	Phillips, Jr.	
3,558,330 A	1/1971	Widiger et al.	
3,616,487 A	11/1971	Dearth	
3,651,930 A	3/1972	Artz	
3,692,175 A	9/1972	Hordler	
D227,979 S *	7/1973	Bird	D9/429
3,751,341 A	8/1973	Seitz et al.	
3,800,998 A	4/1974	Gask	
4,202,465 A	5/1980	McLaren	
4,382,513 A	5/1983	Schirmer et al.	
4,656,068 A	4/1987	Raines	
4,775,076 A	10/1988	Horvath	
4,813,543 A	3/1989	Goldberg	
4,889,731 A	12/1989	Williams, Jr.	

D309,105 S *	7/1990	Fisher et al.	D9/425
4,956,212 A	9/1990	Bekele	
5,114,108 A	5/1992	Olschansky	
5,277,920 A	1/1994	Weaver, Jr.	
5,318,787 A	6/1994	Brauner et al.	
5,330,777 A	7/1994	Mize et al.	
5,345,069 A	9/1994	Grindrod	
5,405,629 A	4/1995	Marnocha et al.	

(Continued)

*Primary Examiner* — Susan Bennett Hattan

*Assistant Examiner* — Brett Miller

(74) *Attorney, Agent, or Firm* — AlbertDhand LLP

(57) **CLAIM**

We claim the ornamental design for a packaging for food product, as shown and described.

**DESCRIPTION**

FIG. 1 is a perspective view of a first embodiment of packaging for food product, showing our new design; FIG. 2 is a bottom view thereof; FIG. 3 is a top view thereof; FIG. 4 is a right side view thereof; FIG. 5 is a left side view thereof; FIG. 6 is a front side view thereof; FIG. 7 is a rear side view thereof; FIG. 8 is a top perspective view of a second embodiment of packaging for food product; FIG. 9 is a bottom view thereof; FIG. 10 is a top view thereof; FIG. 11 is a right side view thereof; FIG. 12 is a left side view thereof; FIG. 13 is a front side view thereof; and, FIG. 14 is a rear side view thereof.

The dash-dot boundary line(s) defines the boundary of the claimed design and forms no part of the claimed design. The broken lines in the drawings form no part of the claimed design and are only for illustrative purposes, and/or to show environmental structure.

**1 Claim, 14 Drawing Sheets**

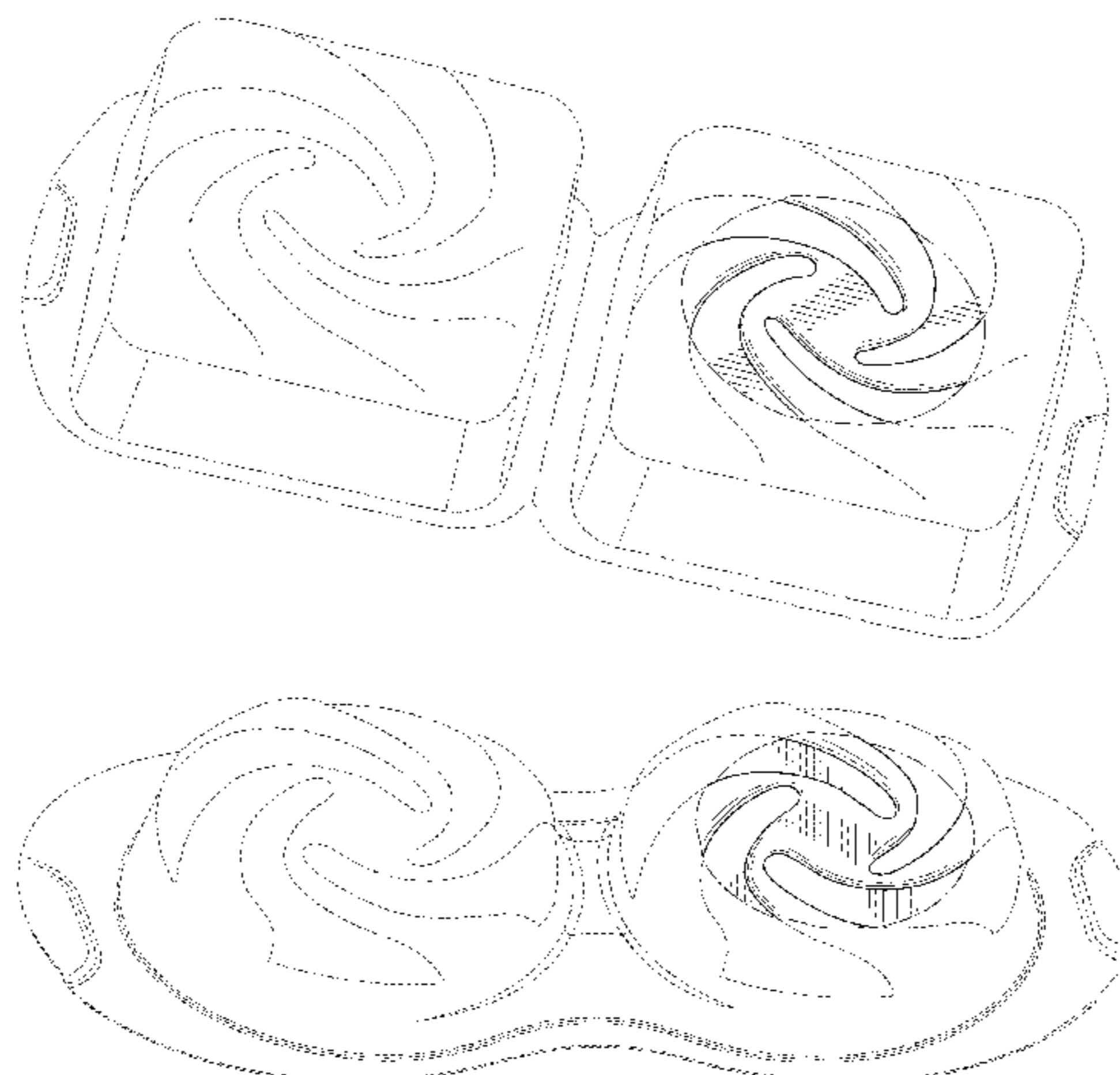

(56)

**References Cited**

U.S. PATENT DOCUMENTS

5,421,473	A	6/1995	McCrossen		
5,543,104	A	8/1996	Stratford et al.		
5,586,677	A	12/1996	Foos		
5,607,709	A	3/1997	Fritz et al.		
5,657,874	A	8/1997	Hustad et al.		
5,782,376	A	7/1998	Brauner et al.		
5,897,011	A	4/1999	Brilliant et al.		
5,908,111	A *	6/1999	Purdy .....	206/461	
5,916,615	A	6/1999	Brady et al.		
5,935,697	A	8/1999	Gasse et al.		
5,989,610	A	11/1999	Ruzek		
D420,285	S *	2/2000	Sagan et al. ....	D9/429	
6,042,862	A	3/2000	Kocher et al.		
6,119,862	A	9/2000	Childress		
D440,490	S *	4/2001	Lizzio .....	D9/428	
D447,910	S *	9/2001	Brown .....	D7/396.1	
D457,781	S *	5/2002	Brown .....	D7/396.1	
D468,201	S *	1/2003	Huber .....	D9/428	
6,572,909	B1	6/2003	Bagwell et al.		
6,598,740	B1	7/2003	Wiegers		
6,616,998	B2	9/2003	Greer et al.		
6,667,082	B2	12/2003	Bamore et al.		
6,669,046	B1	12/2003	Sawada et al.		
6,670,023	B2	12/2003	Mueller		
6,672,473	B2	1/2004	Torniainen et al.		
6,769,227	B2	8/2004	Mumpower et al.		
6,861,127	B2	3/2005	Glawe et al.		
D509,109	S *	9/2005	Vovan .....	D7/602	
6,979,494	B2	12/2005	Berrier et al.		
7,056,593	B2	6/2006	Kennedy et al.		
7,205,016	B2	4/2007	Garwood		
7,261,219	B2	8/2007	Tucker et al.		
7,415,428	B2	8/2008	Garwood		
D587,995	S *	3/2009	Studee .....	D9/424	
7,549,551	B2	6/2009	Tyberghein		
7,575,770	B2	8/2009	Garwood		
7,671,308	B2	3/2010	Kreisman et al.		
7,726,483	B2	6/2010	Ramanujam et al.		
7,731,997	B2	6/2010	Castellanos et al.		
7,802,695	B2	9/2010	Baker et al.		
D629,683	S *	12/2010	Fang .....	D9/429	
7,862,318	B2	1/2011	Middleton et al.		
7,882,974	B2	2/2011	Evans et al.		
7,993,692	B2	8/2011	Finley et al.		
D644,924	S *	9/2011	Lin .....	D9/429	
8,025,179	B2	9/2011	Miller et al.		
D673,849	S *	1/2013	Barbier .....	D9/429	
2003/0138653	A1	7/2003	Rieblinger et al.		
2003/0170359	A1	9/2003	Garwood		
2003/0183637	A1	10/2003	Zappa et al.		
2003/0203799	A1	10/2003	VandenHeuvel et al.		
2003/0215551	A1	11/2003	Garwood		
2004/0185154	A1	9/2004	Garwood		
2005/0077297	A1	4/2005	Marshburn et al.		
2005/0150891	A1	7/2005	Schalk et al.		
2006/0068063	A1	3/2006	Zerfas et al.		
2006/0147588	A1	7/2006	Garwood		
2006/0191935	A1	8/2006	Tuszkiewicz et al.		
2007/0116805	A1	5/2007	Castellanos et al.		
2008/0113133	A1	5/2008	Fackler et al.		
2008/0248162	A1	10/2008	Cook et al.		
2009/0159483	A1	6/2009	Hinze et al.		
2009/0194451	A1	8/2009	Leiner et al.		
2009/0234042	A1	9/2009	Luinstra		
2009/0291174	A1	11/2009	Lewis		
2010/0065562	A1	3/2010	Vovan		
2010/0176122	A1	7/2010	Tuszkiewicz et al.		
2010/0255162	A1	10/2010	Becraft et al.		
2010/0307116	A1	12/2010	Fisher		
2011/0012291	A1	1/2011	Middleton et al.		
2011/0056949	A1	3/2011	Reiterer et al.		
2011/0086141	A1	4/2011	Strilich et al.		
2011/0240644	A1	10/2011	Kimmell et al.		
2011/0247961	A1	10/2011	Mondini		

\* cited by examiner

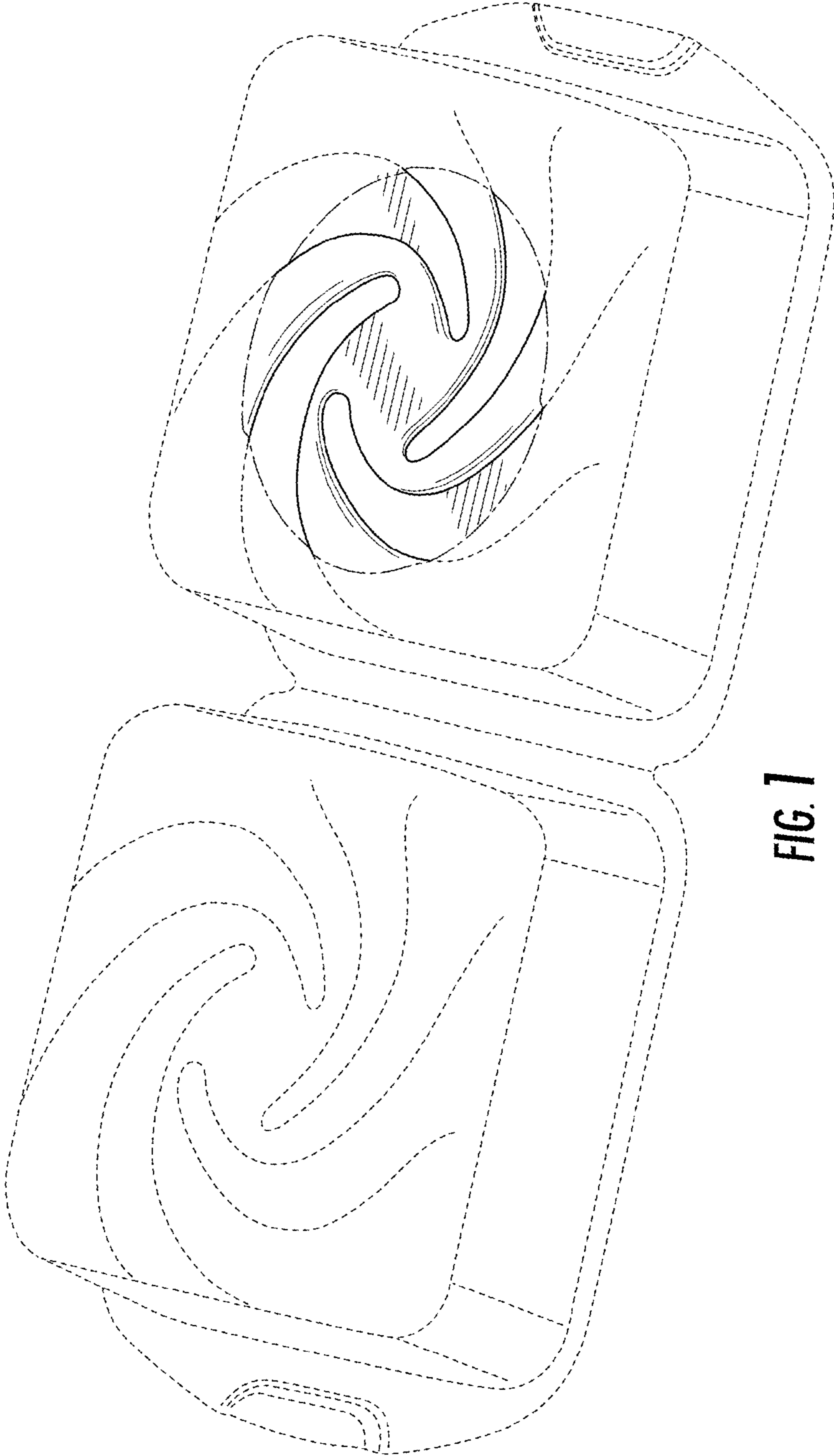

FIG. 1

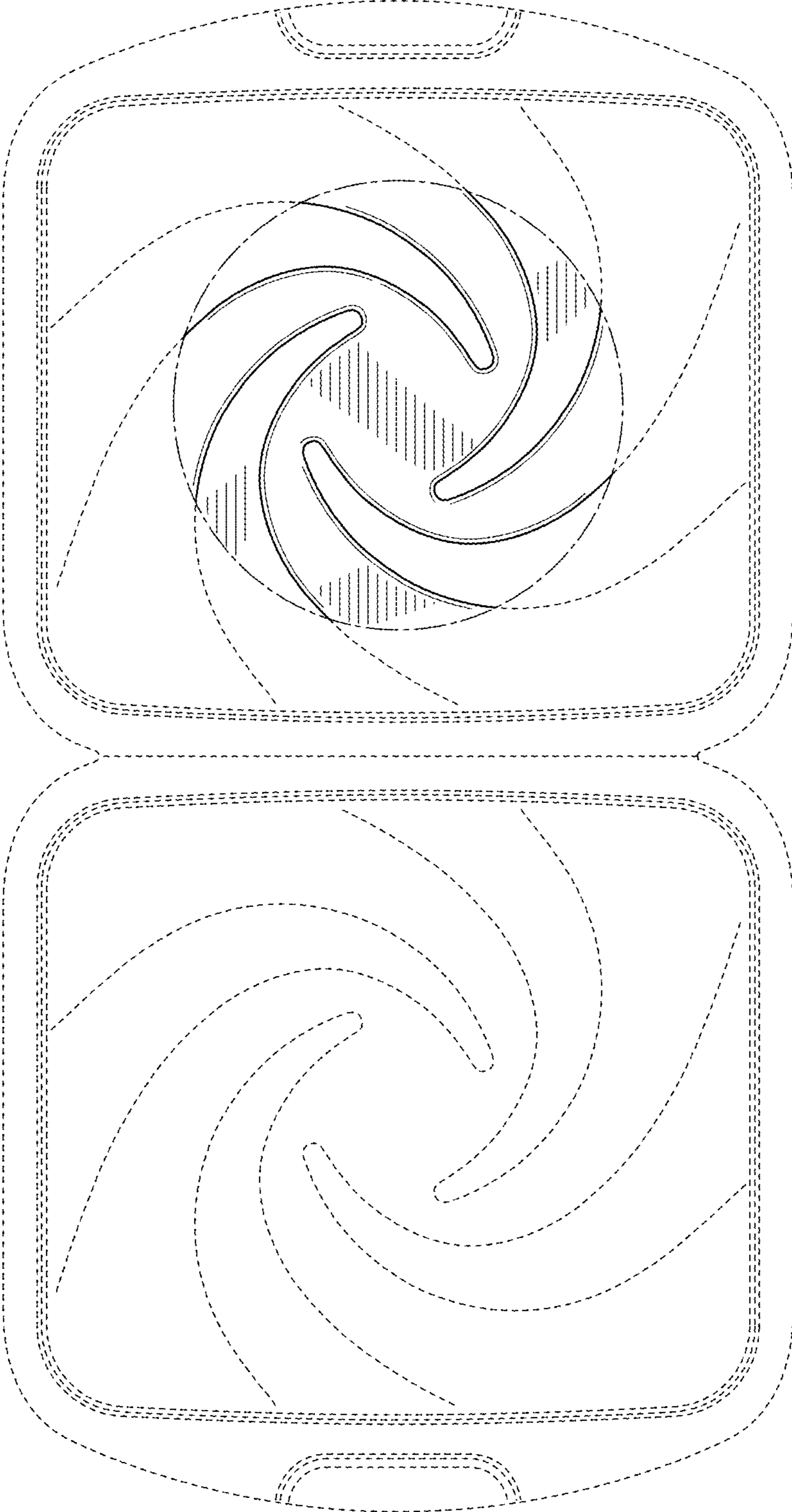

FIG. 2

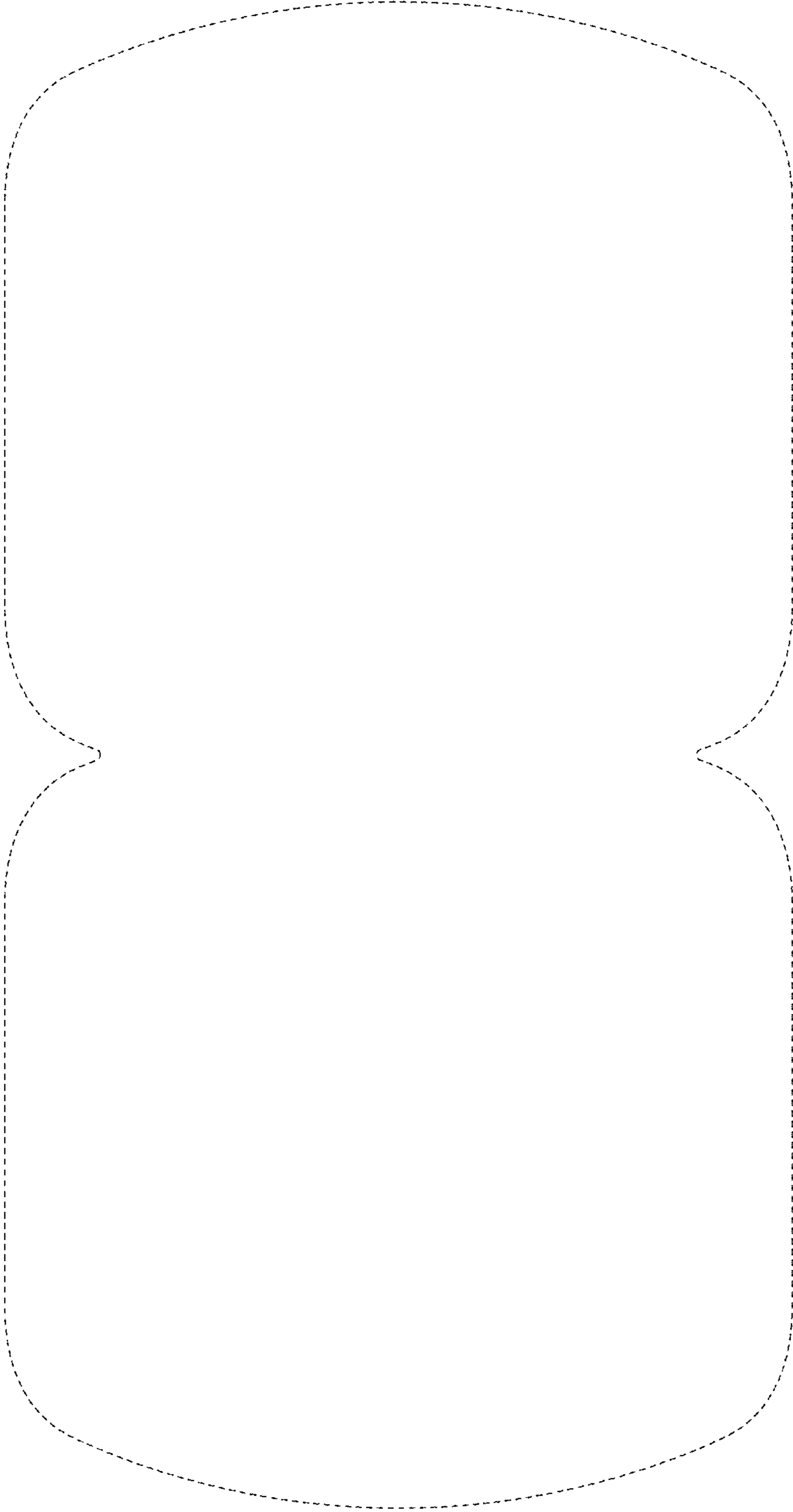

FIG. 3

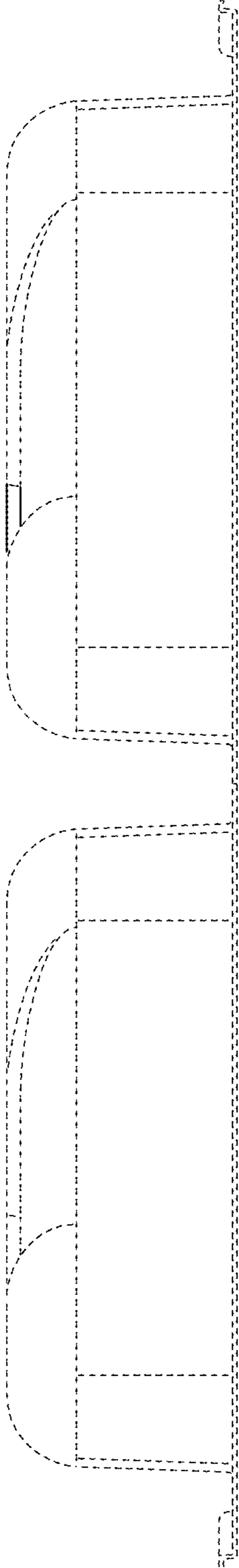
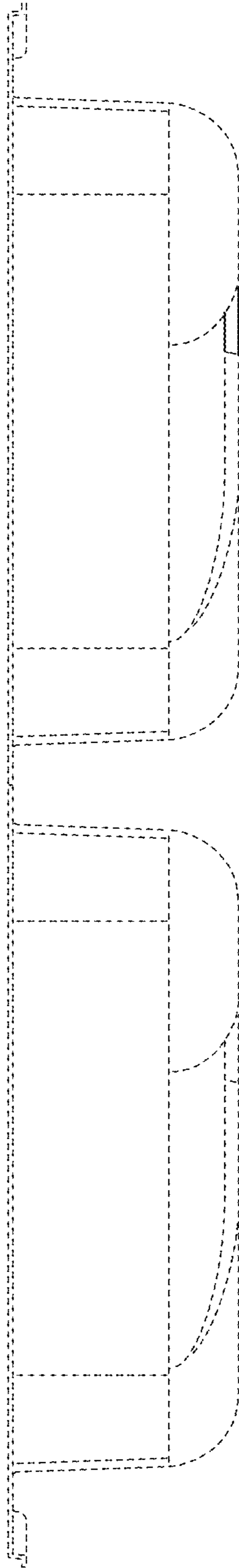
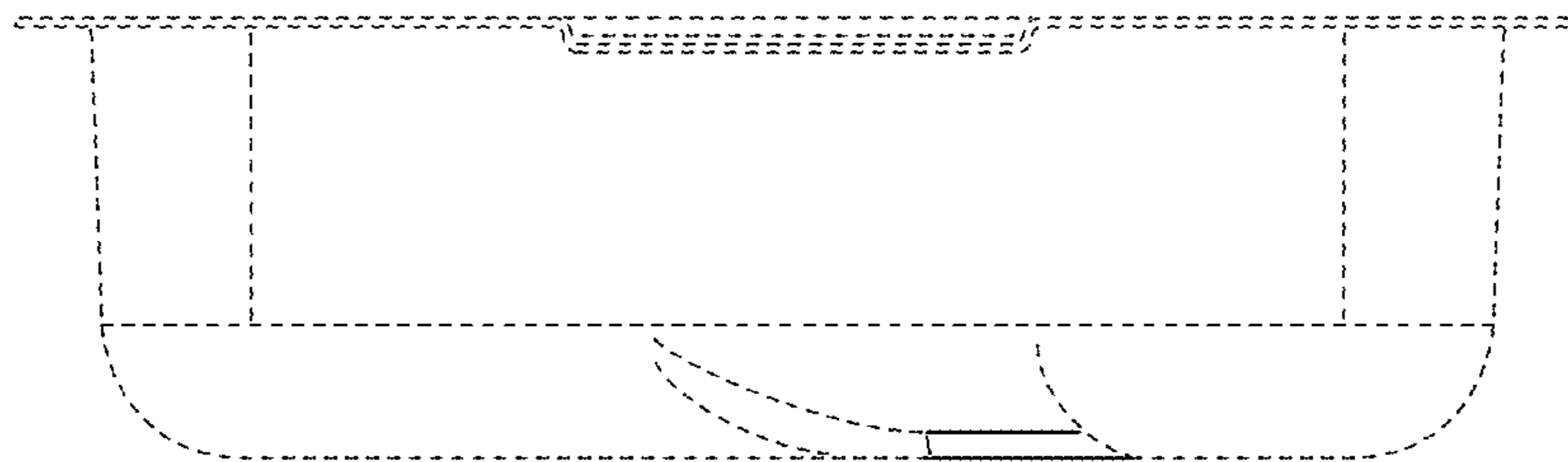

FIG. 4

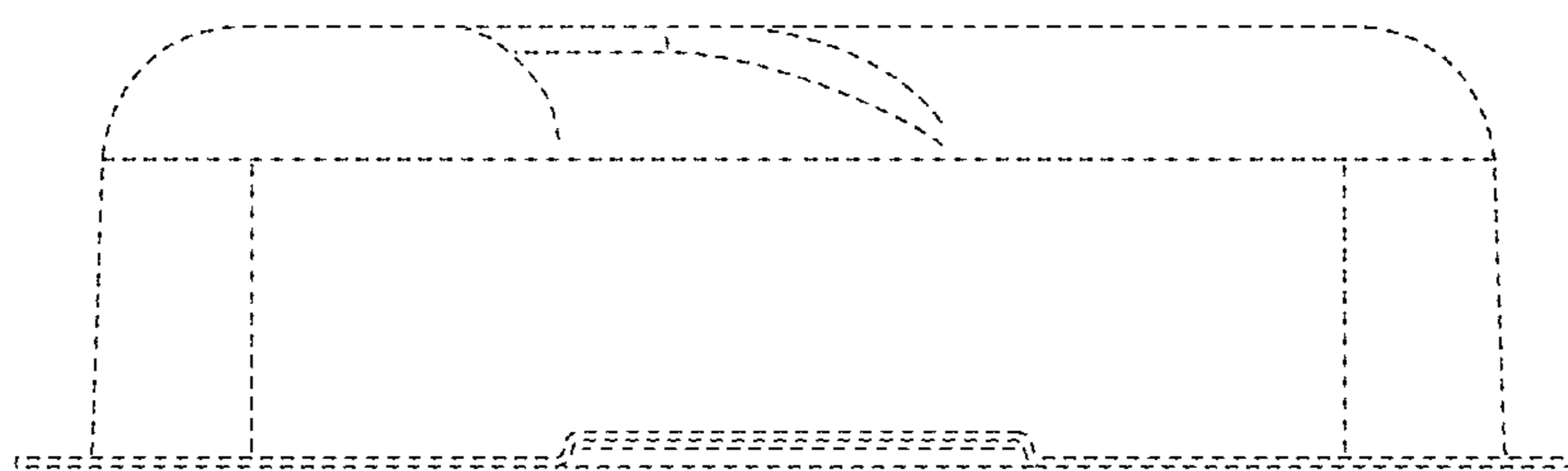

**FIG. 5**



**FIG. 6**





**FIG. 7**

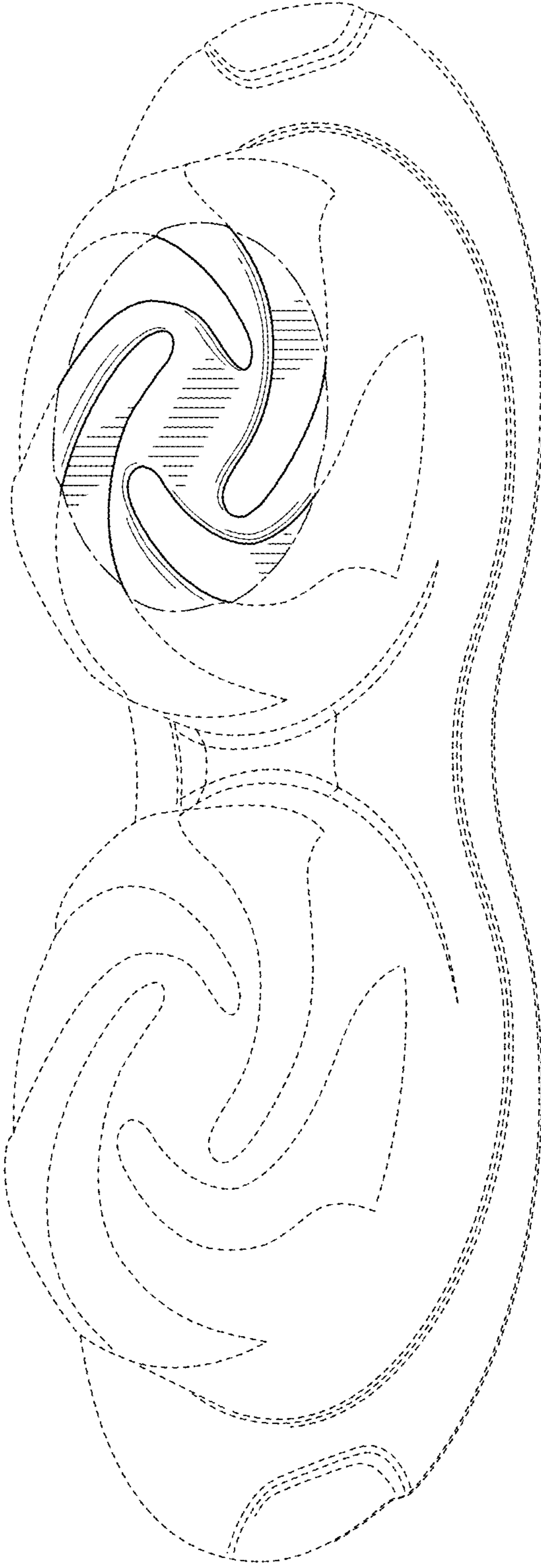
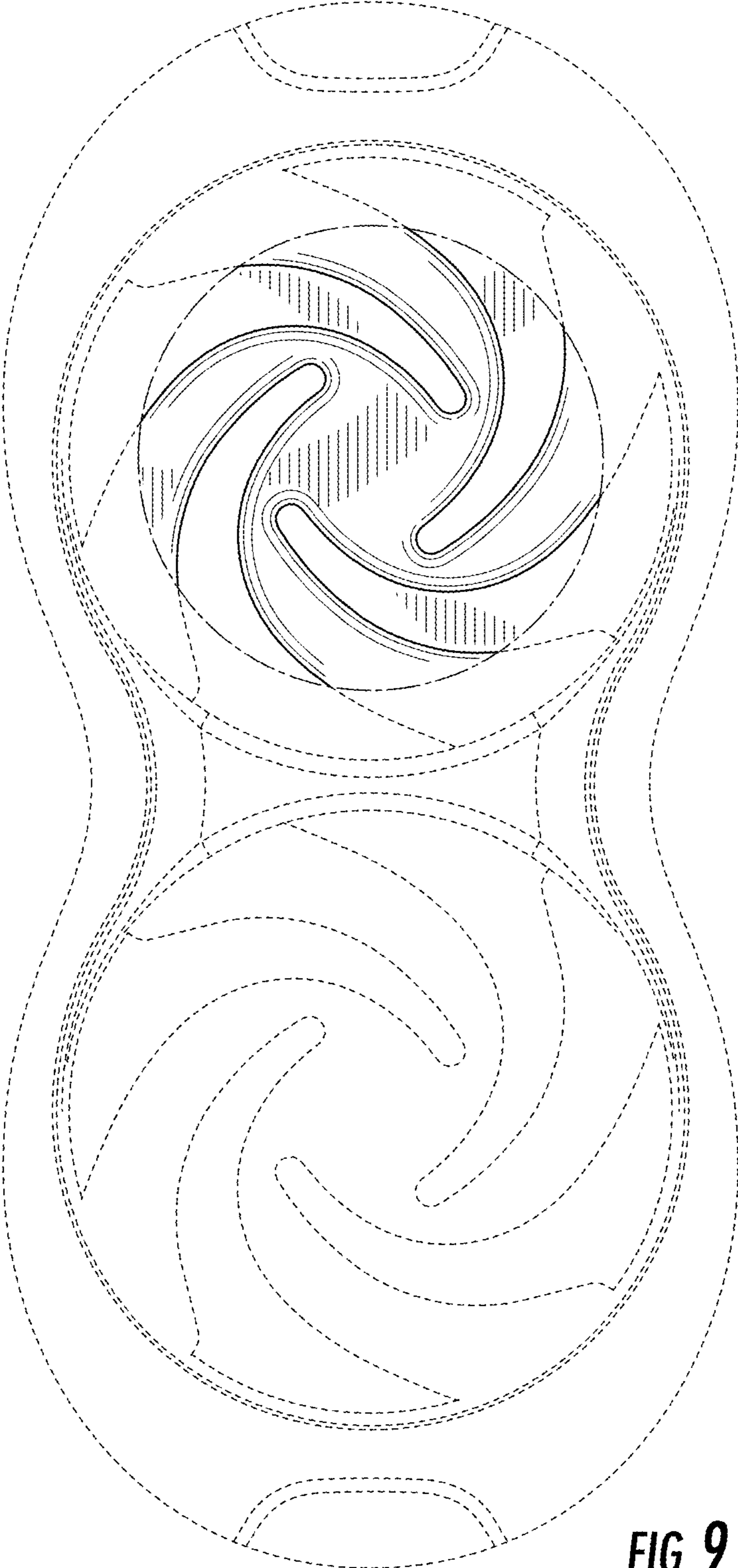
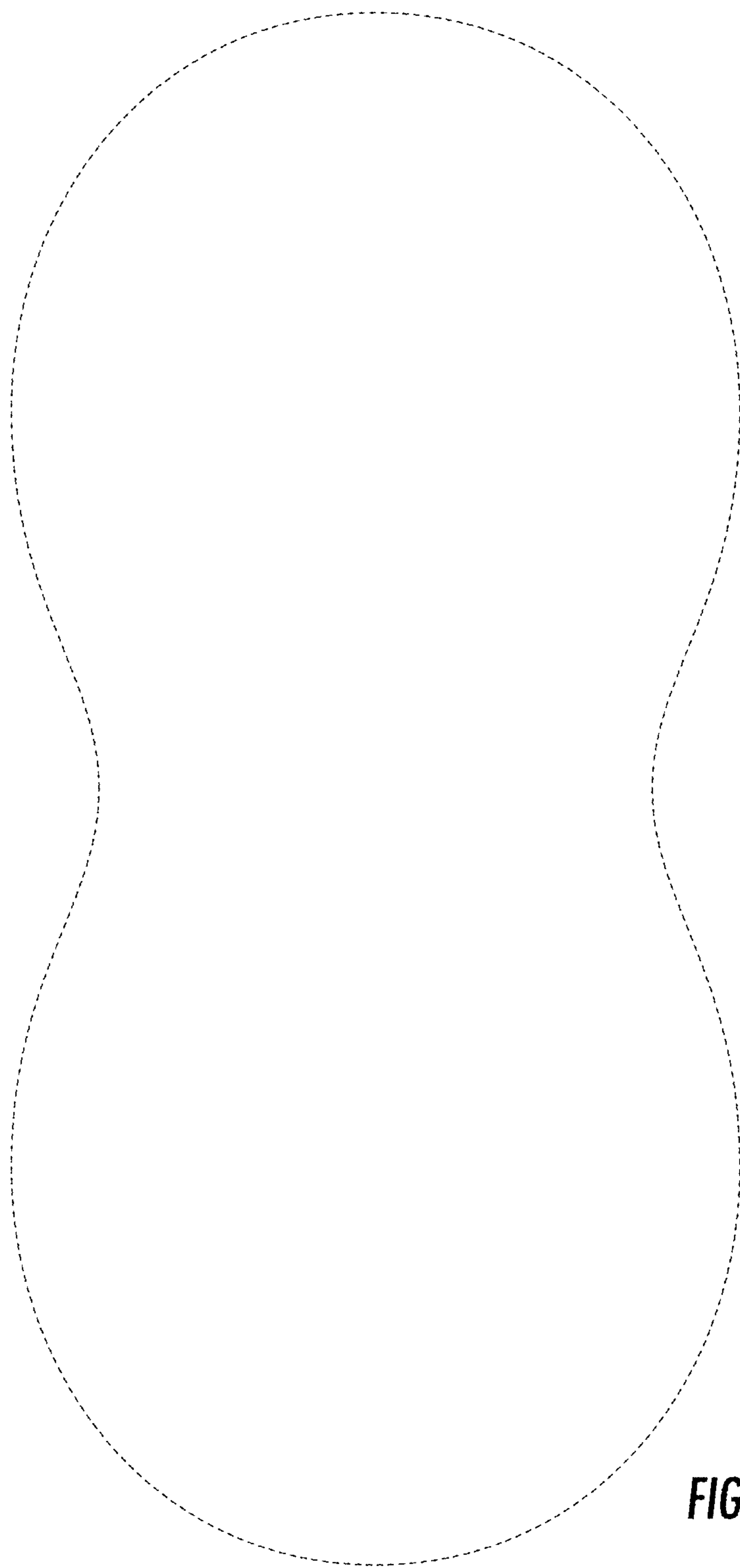

FIG. 8



**FIG. 9**



**FIG. 10**

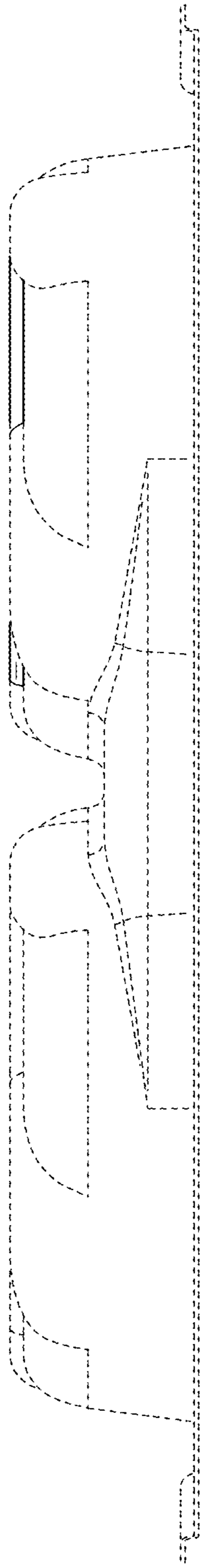

**FIG. 11**

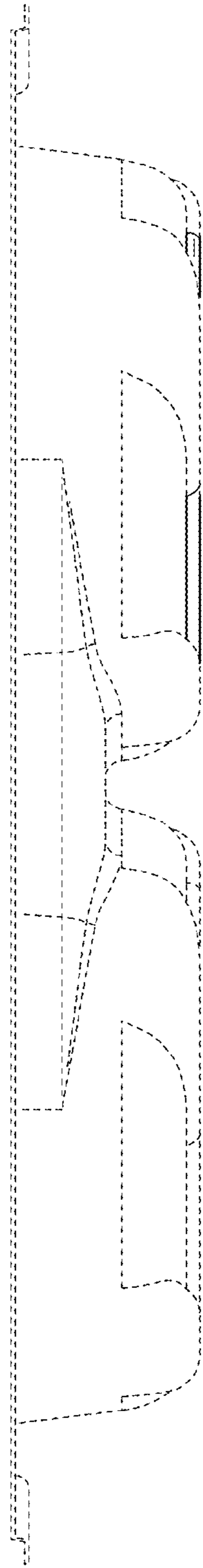

**FIG. 12**

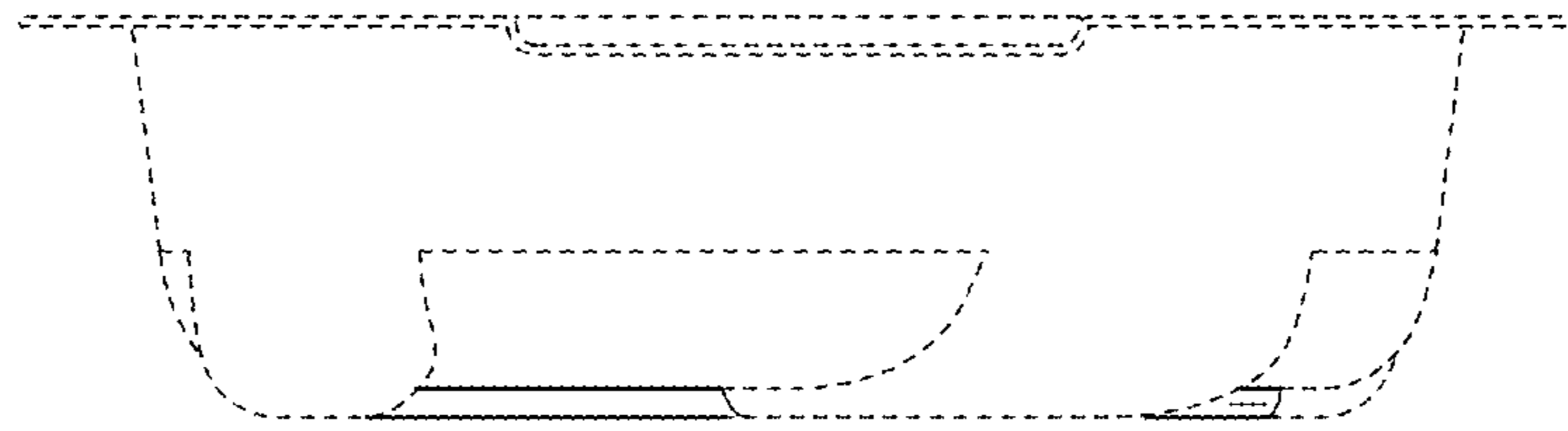

**FIG. 13**

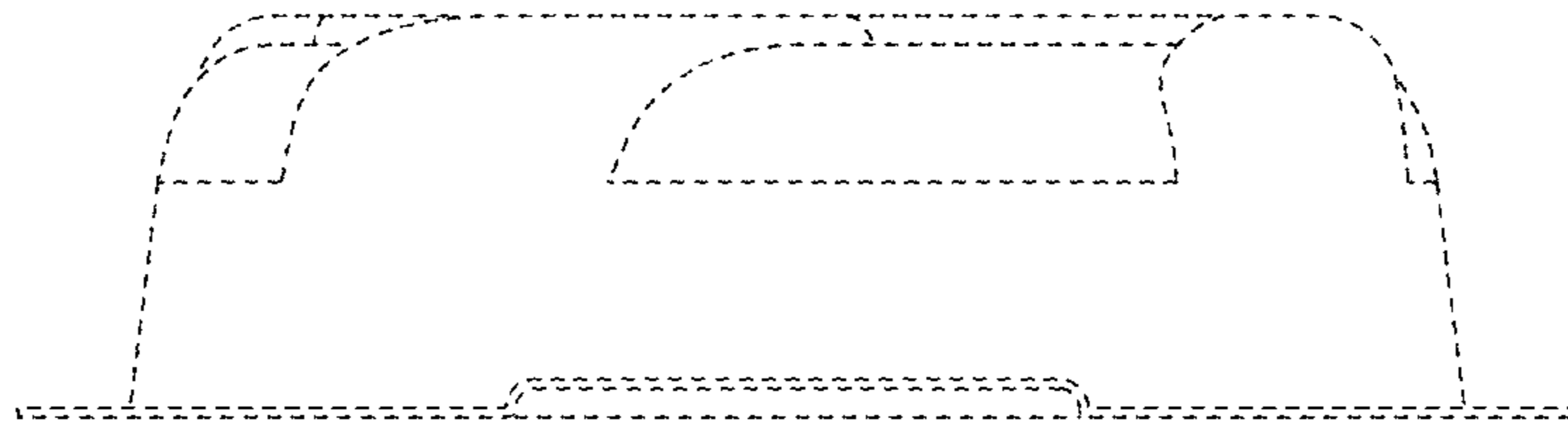

**FIG. 14**