



US00D704470S

(12) **United States Design Patent**
Welborn

(10) **Patent No.:** **US D704,470 S**

(45) **Date of Patent:** **** May 13, 2014**

(54) **CHAIR**

(71) Applicant: **Robert Edley Welborn**, Santa Fe, NM
(US)

(72) Inventor: **Robert Edley Welborn**, Santa Fe, NM
(US)

(**) Term: **14 Years**

(21) Appl. No.: **29/433,500**

(22) Filed: **Oct. 1, 2012**

(51) **LOC (10) Cl.** **06-01**

(52) **U.S. Cl.**
USPC **D6/379**

(58) **Field of Classification Search**
USPC D6/334-336, 370, 371-373, 374, 376,
D6/379, 380, 716, 716.1, 716.2, 716.3,
D6/716.4; 297/440.2, 440.22, 445.1,
297/446.1, 452.18, 447.2, 448.1

See application file for complete search history.

(56) **References Cited**

U.S. PATENT DOCUMENTS

D141,839 S * 7/1945 Risom D6/374
D165,788 S * 1/1952 Risom D6/379

* cited by examiner

Primary Examiner — Mimosa De

(74) *Attorney, Agent, or Firm* — Ostrolenk Faber LLP

(57) **CLAIM**

The ornamental design for a chair, as shown and described.

DESCRIPTION

FIG. 1 is a perspective view of a chair showing my new design;

FIG. 2 is a top view thereof;

FIG. 3 is a front view thereof;

FIG. 4 is a side view thereof, the opposite side view being a mirror image thereof;

FIG. 5 is a rear view thereof; and

FIG. 6 is a bottom view thereof.

FIG. 7 is a perspective view of another embodiment of a chair showing my design;

FIG. 8 is a top view thereof;

FIG. 9 is a front view thereof;

FIG. 10 is a side view thereof, the opposite side view being a mirror image thereof;

FIG. 11 is a rear view thereof; and,

FIG. 12 is a bottom view thereof.

The broken lines show environmental matter that forms no part of the claimed design. The stippling provided on the seat and chair back illustrates contrasting appearance of these portions of the design with respect to those portions that do not include stippling.

1 Claim, 6 Drawing Sheets

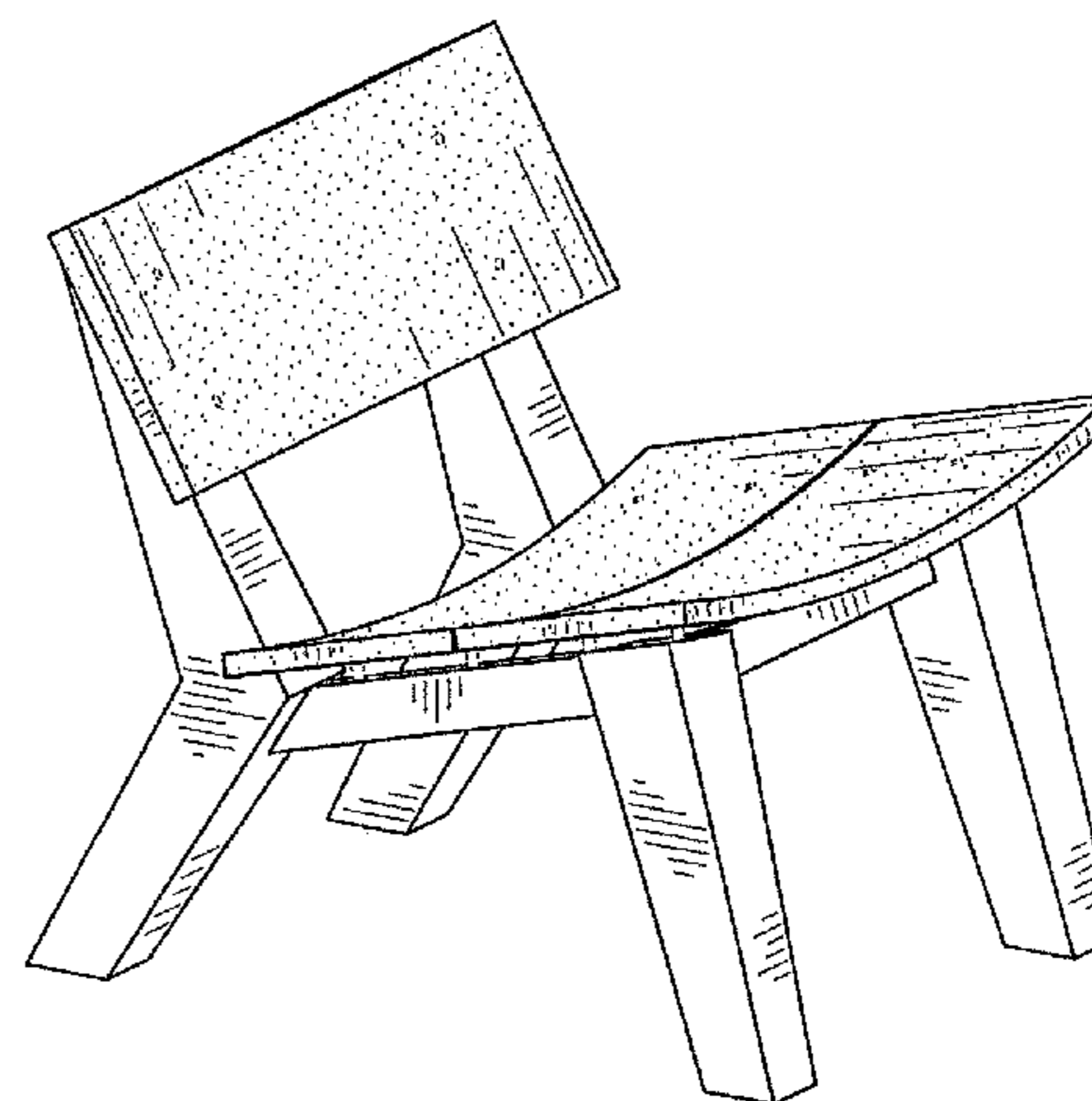
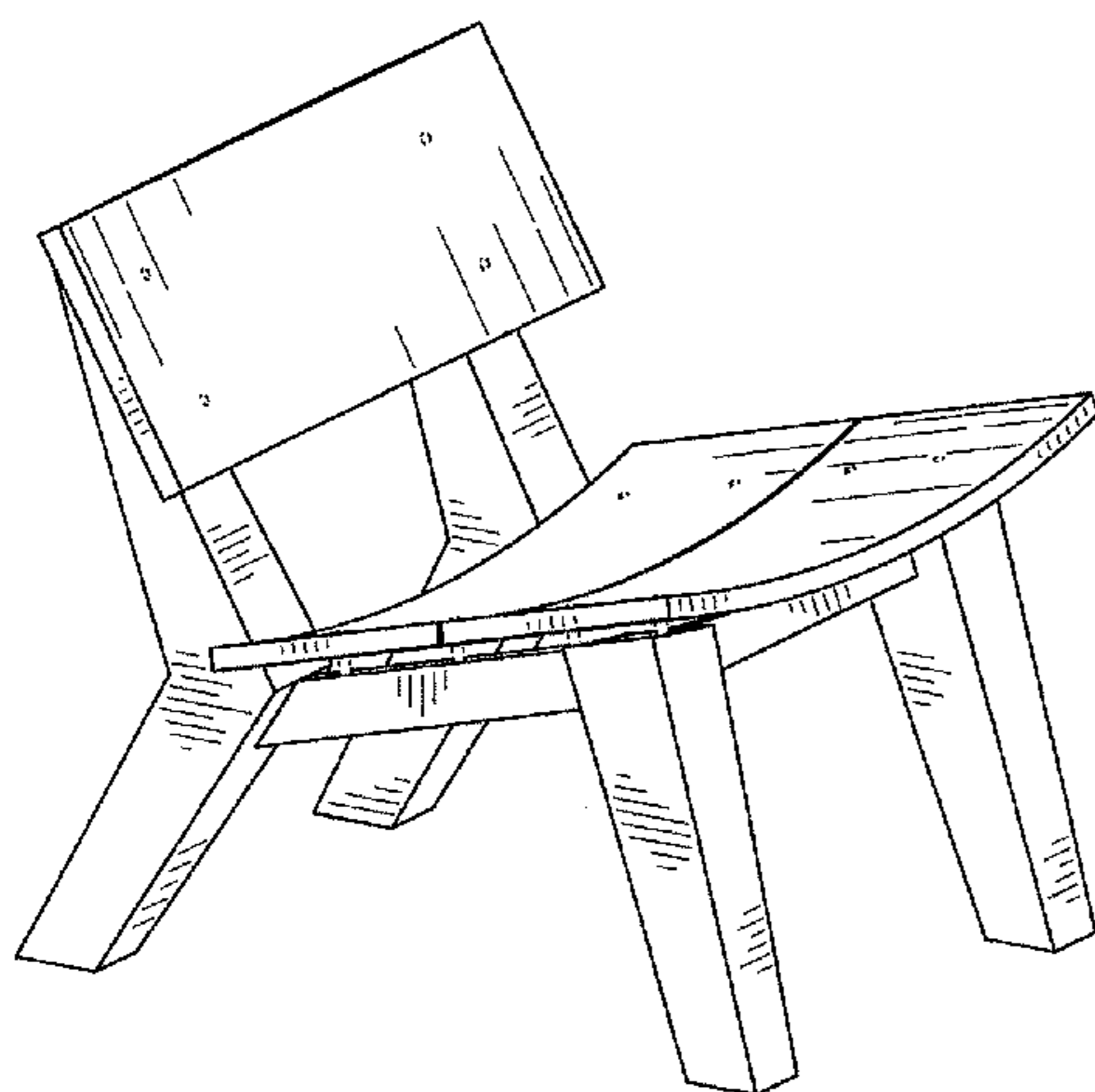

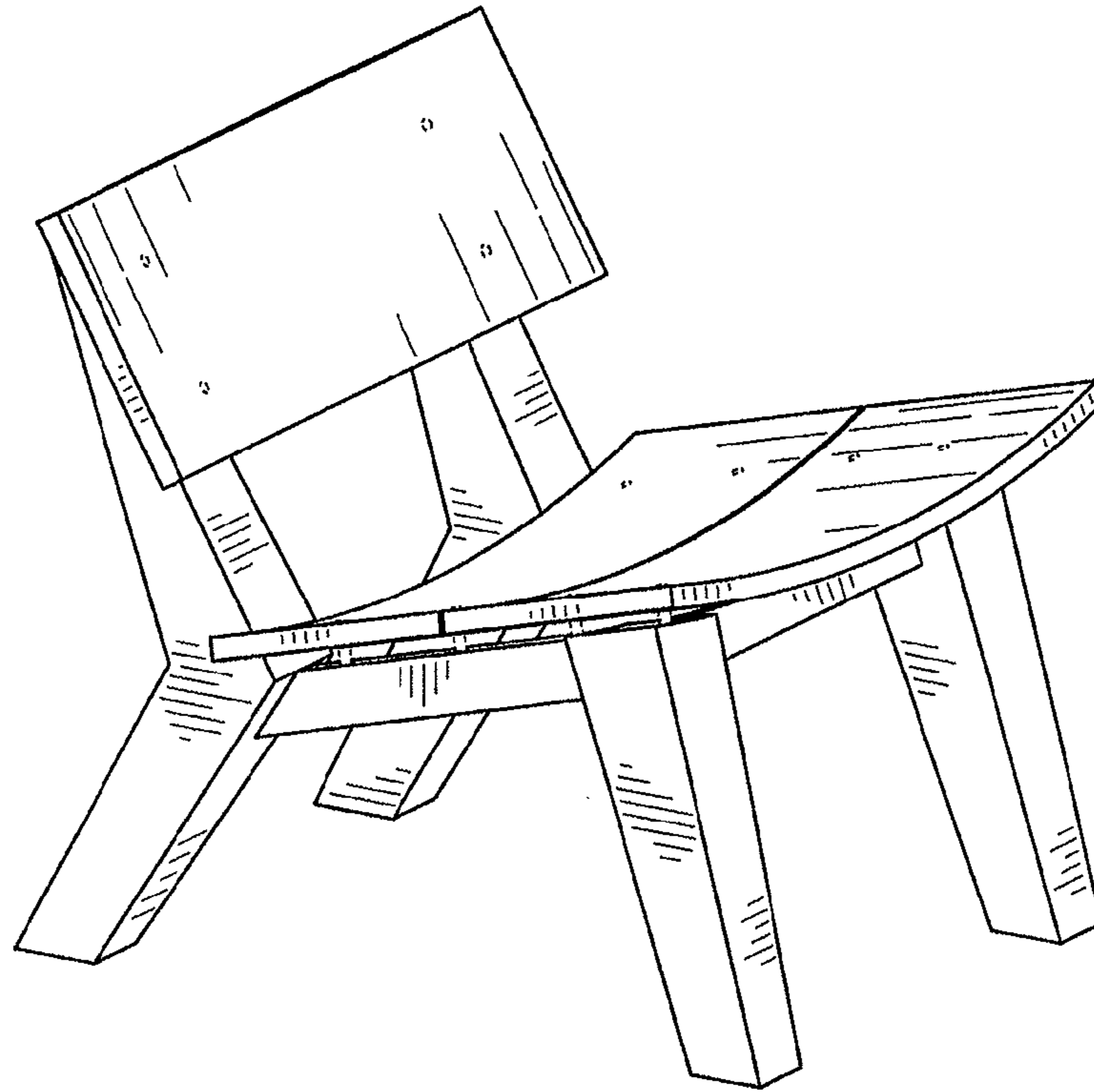

FIG. 1

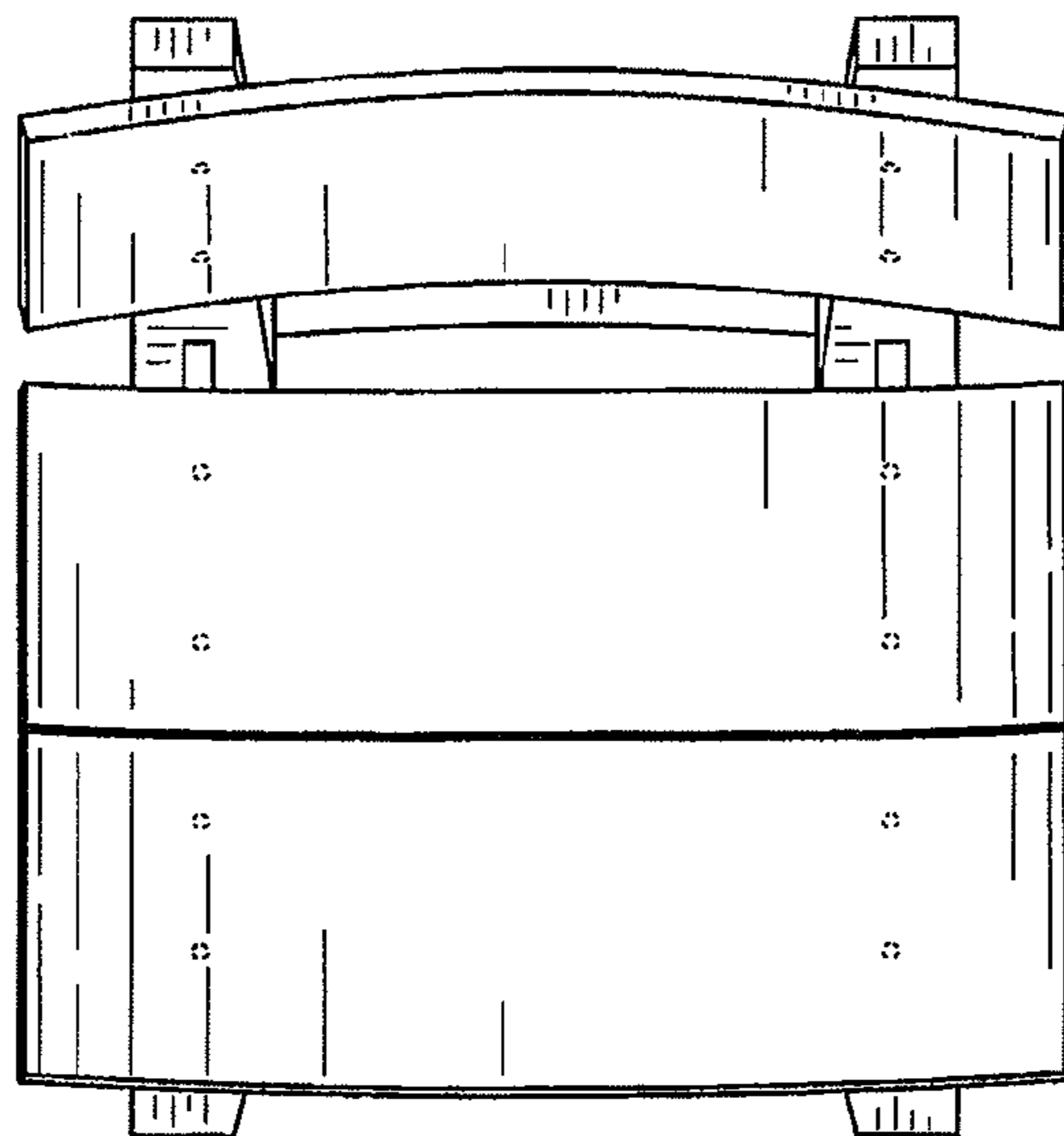

FIG. 2

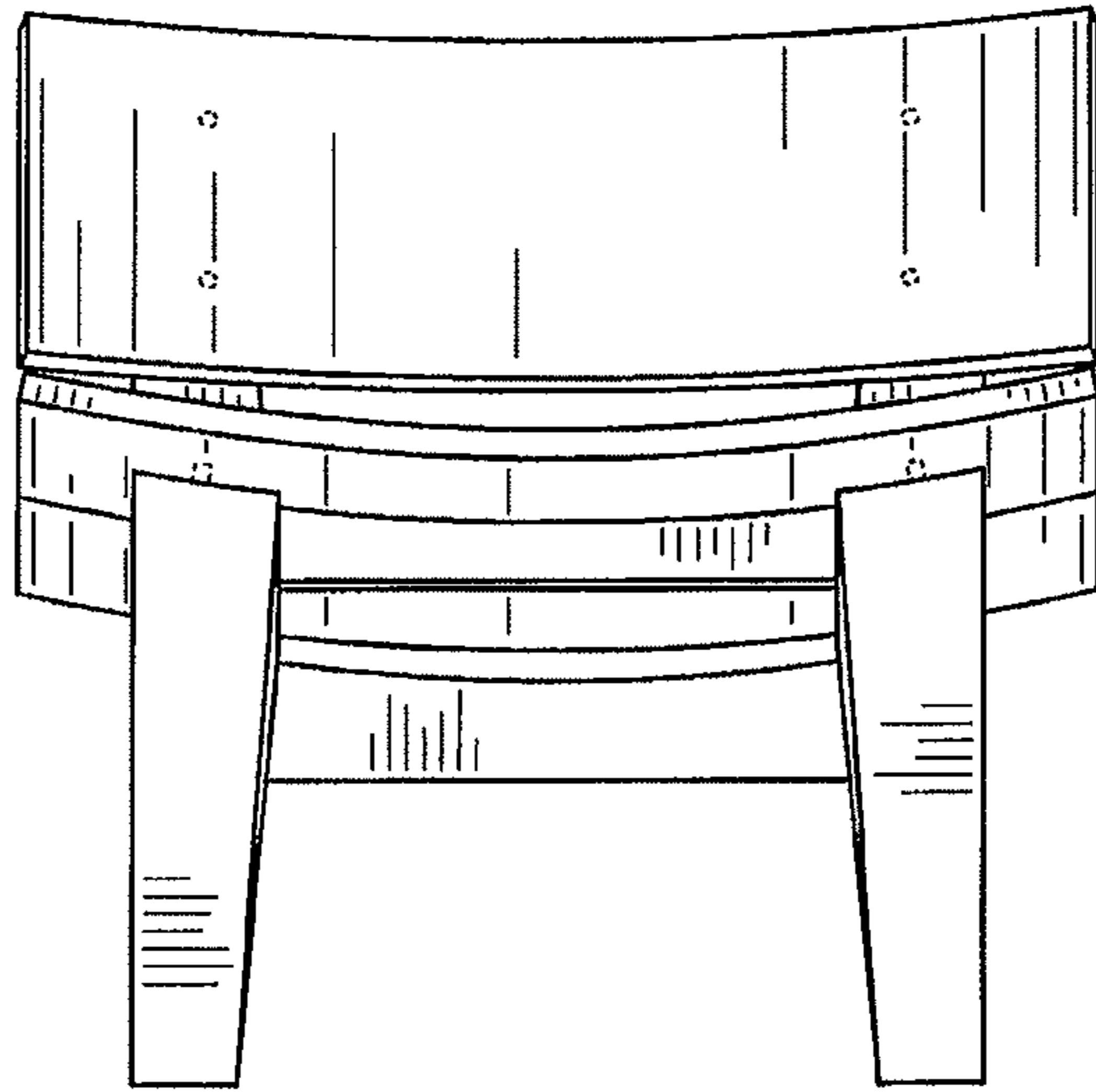

FIG. 3

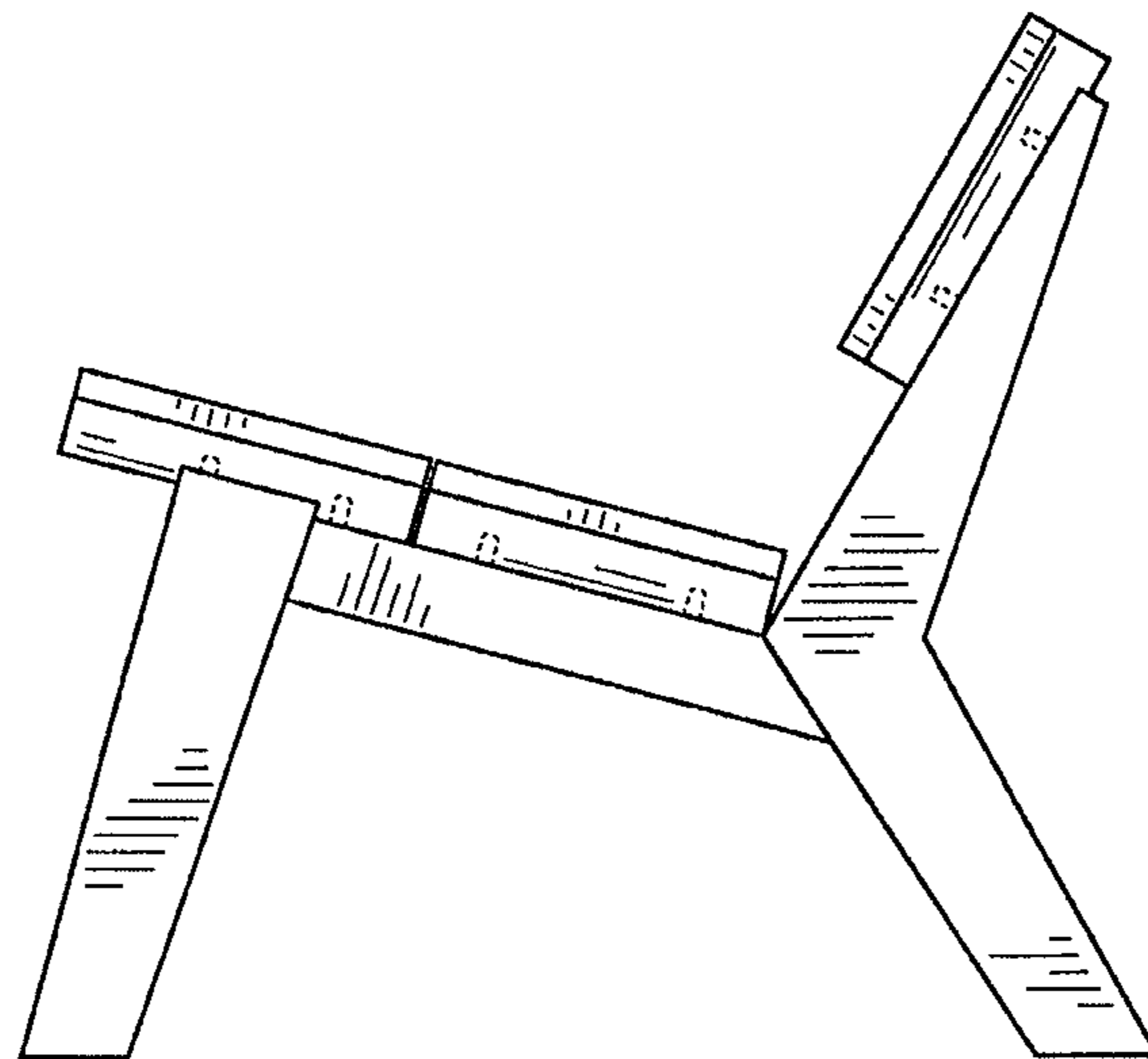

FIG. 4

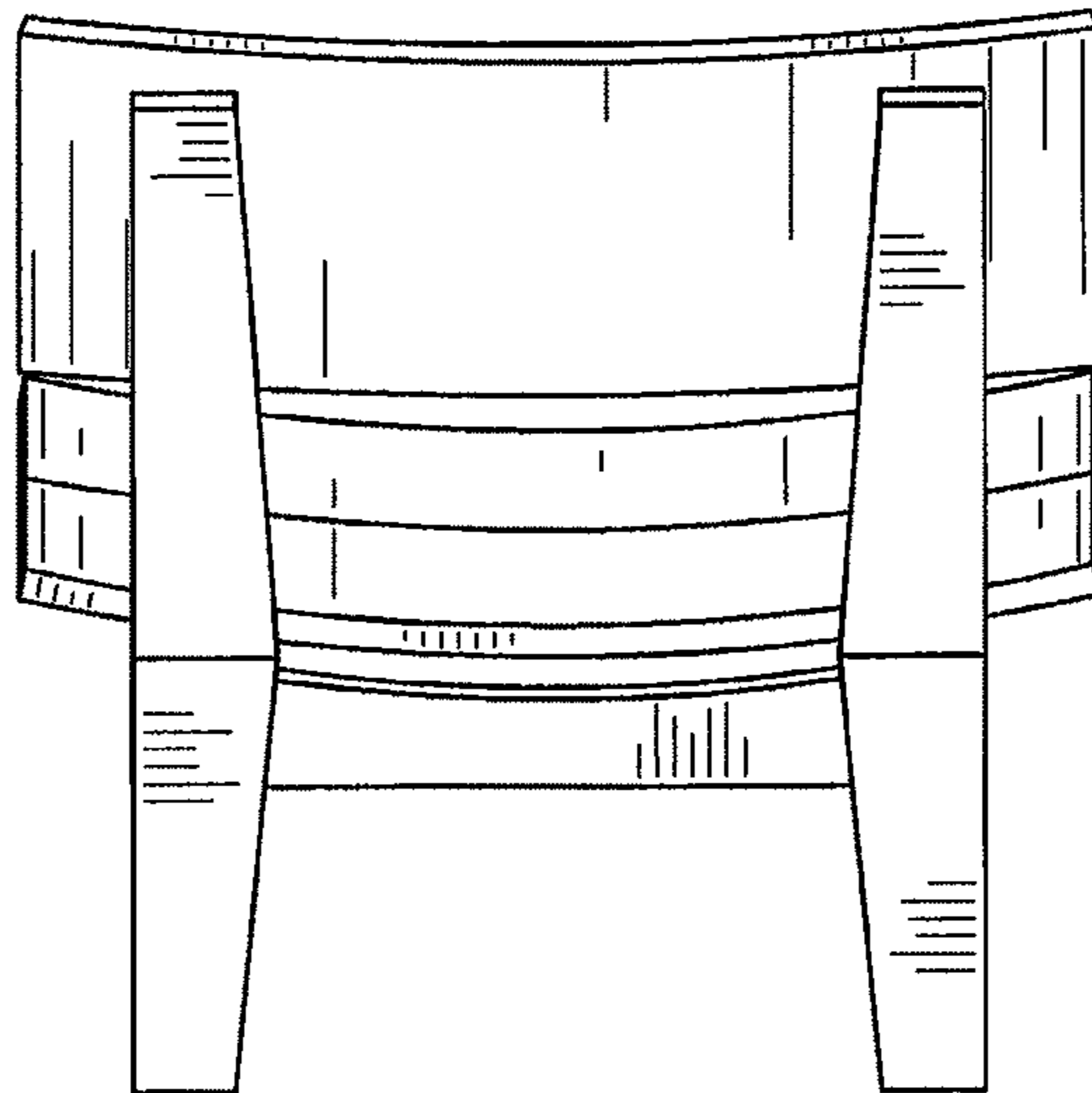

FIG. 5

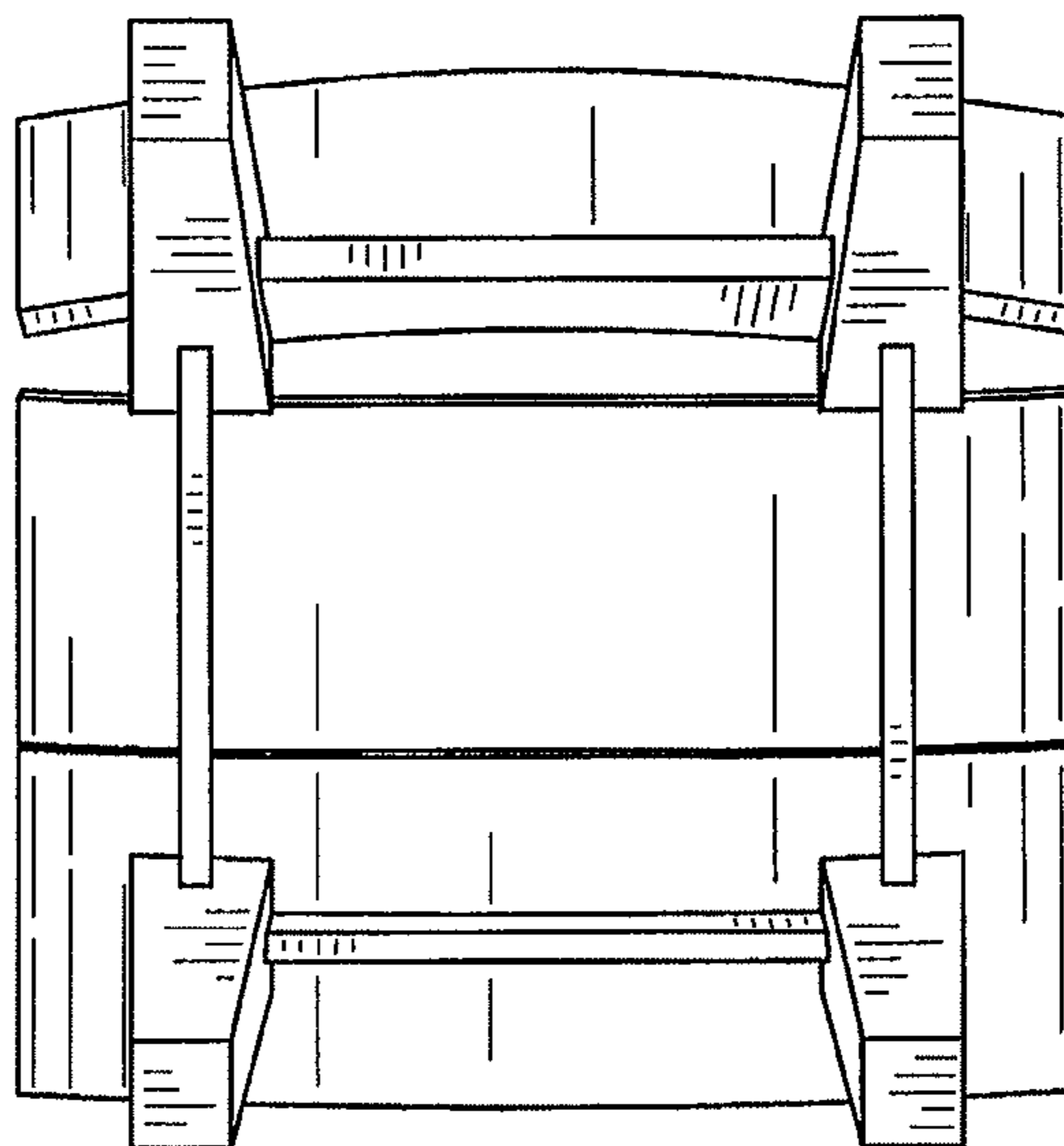

FIG. 6

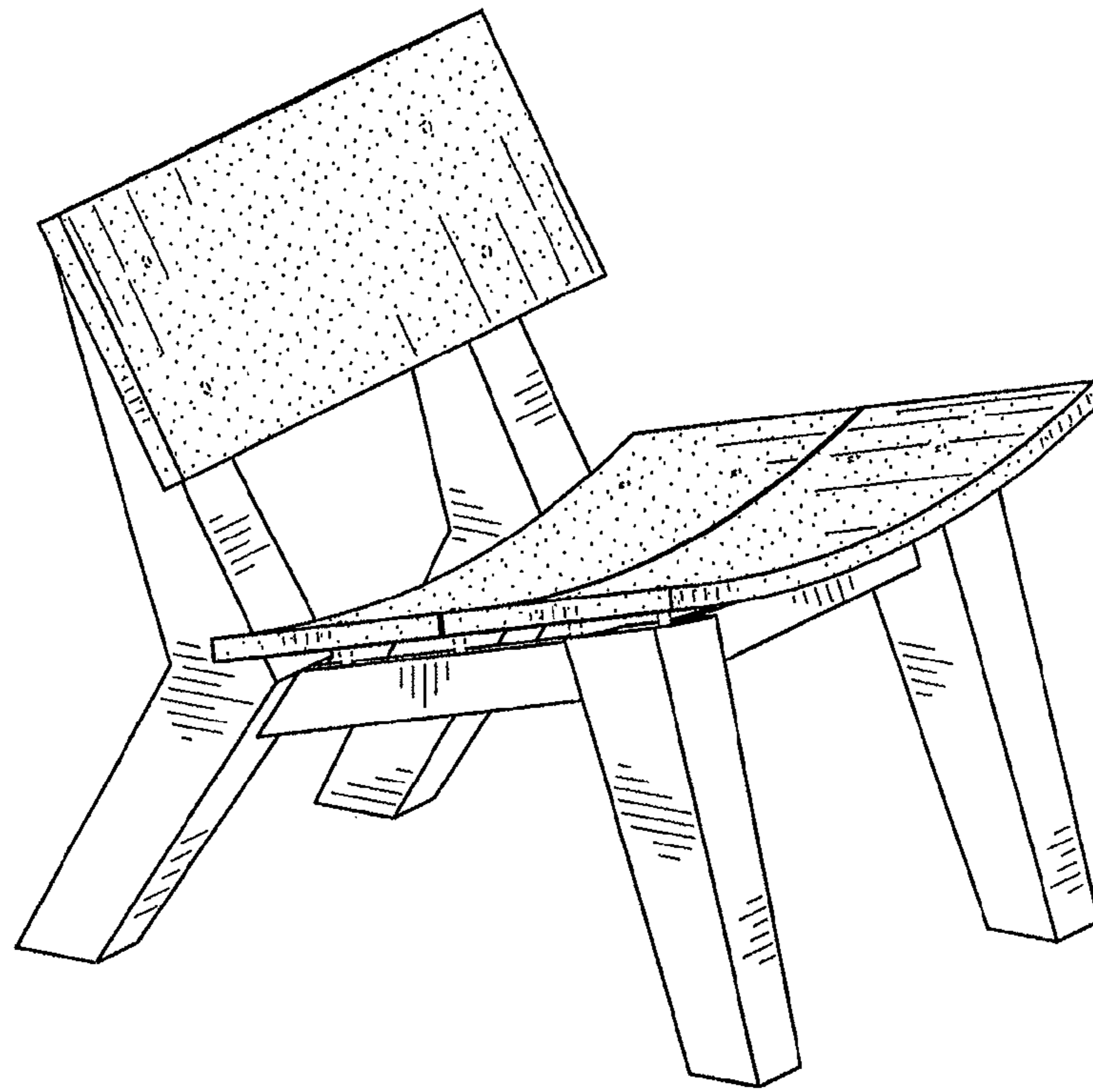

FIG. 7

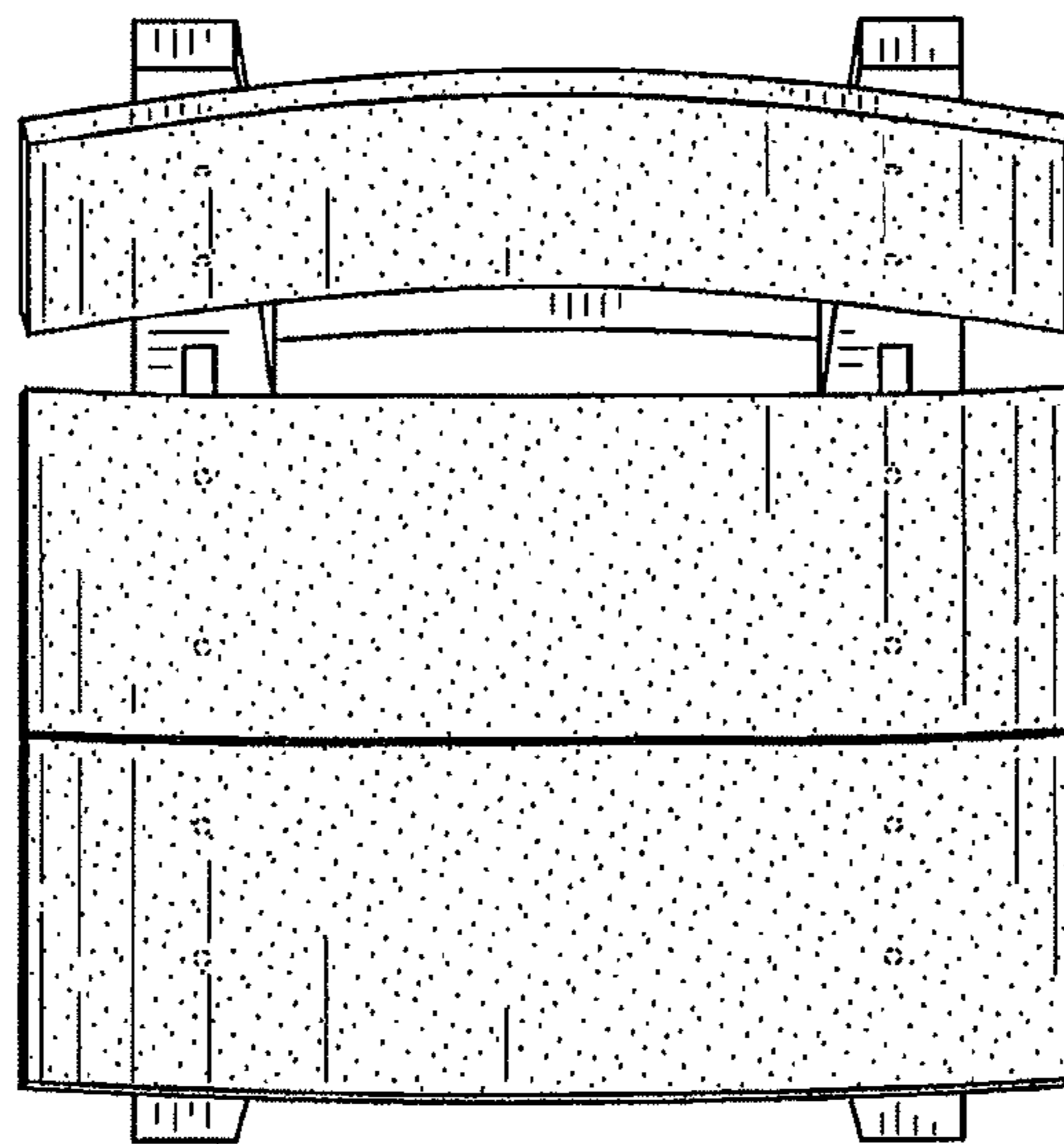

FIG. 8

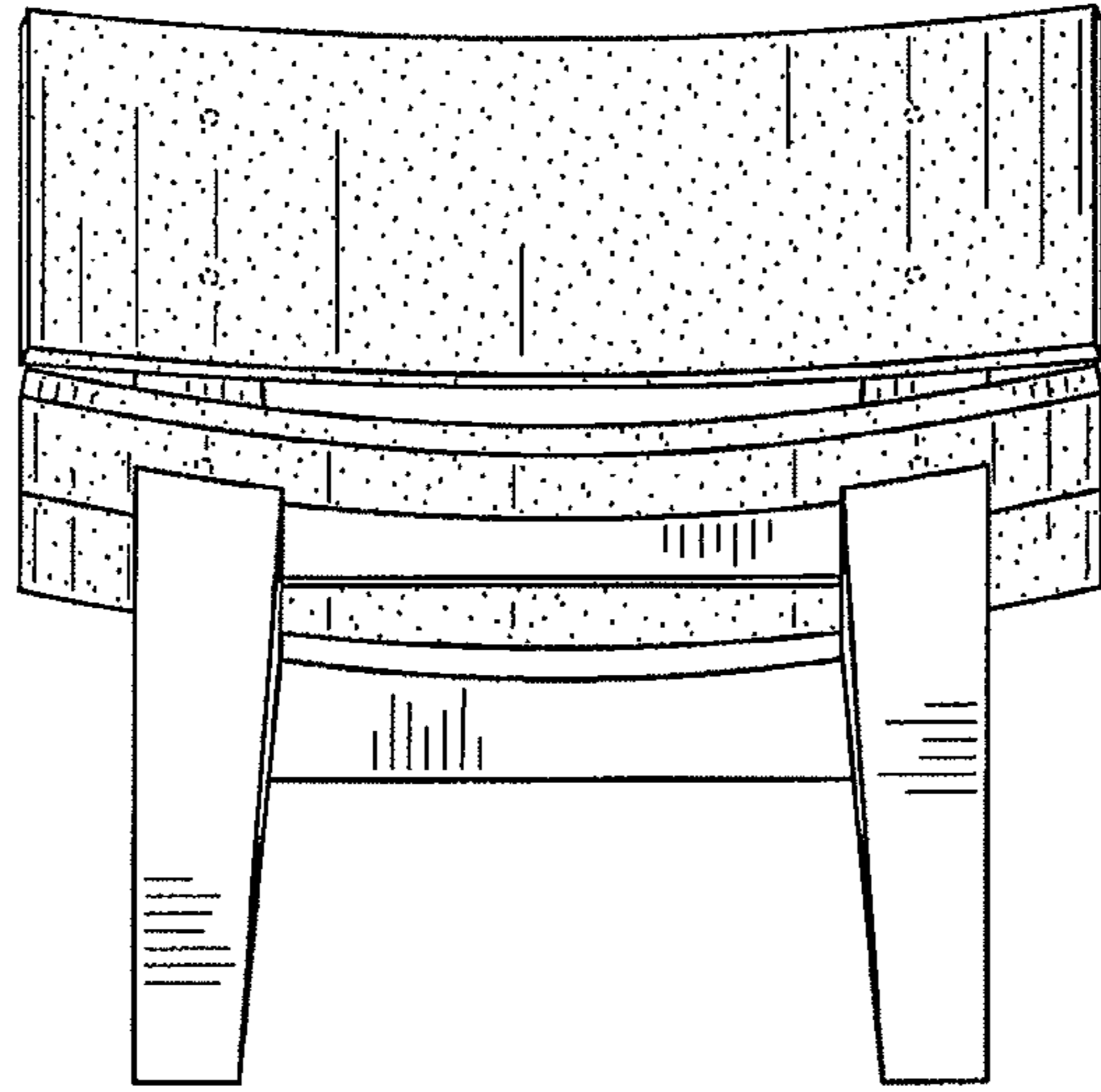

FIG. 9

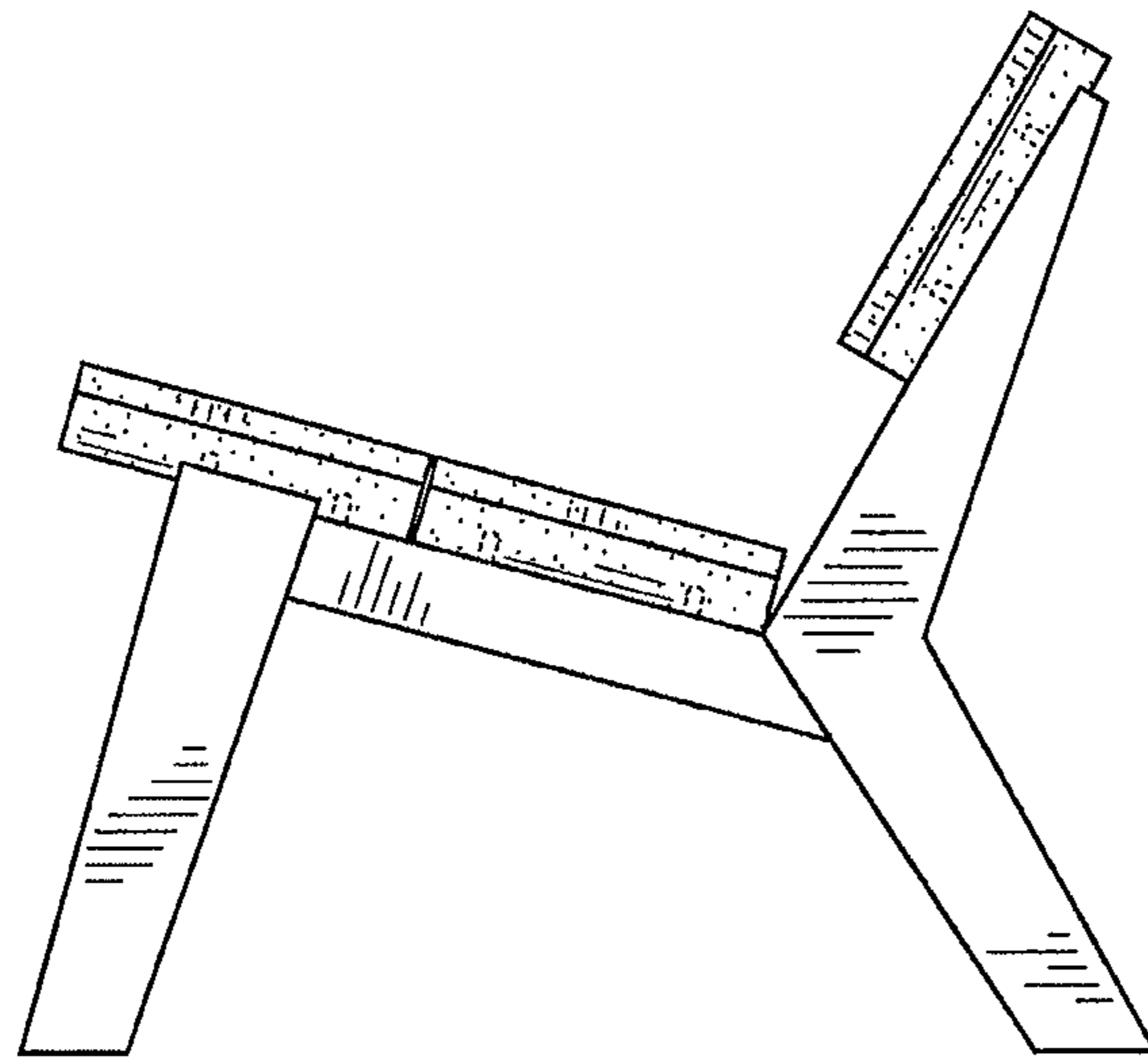

FIG. 10

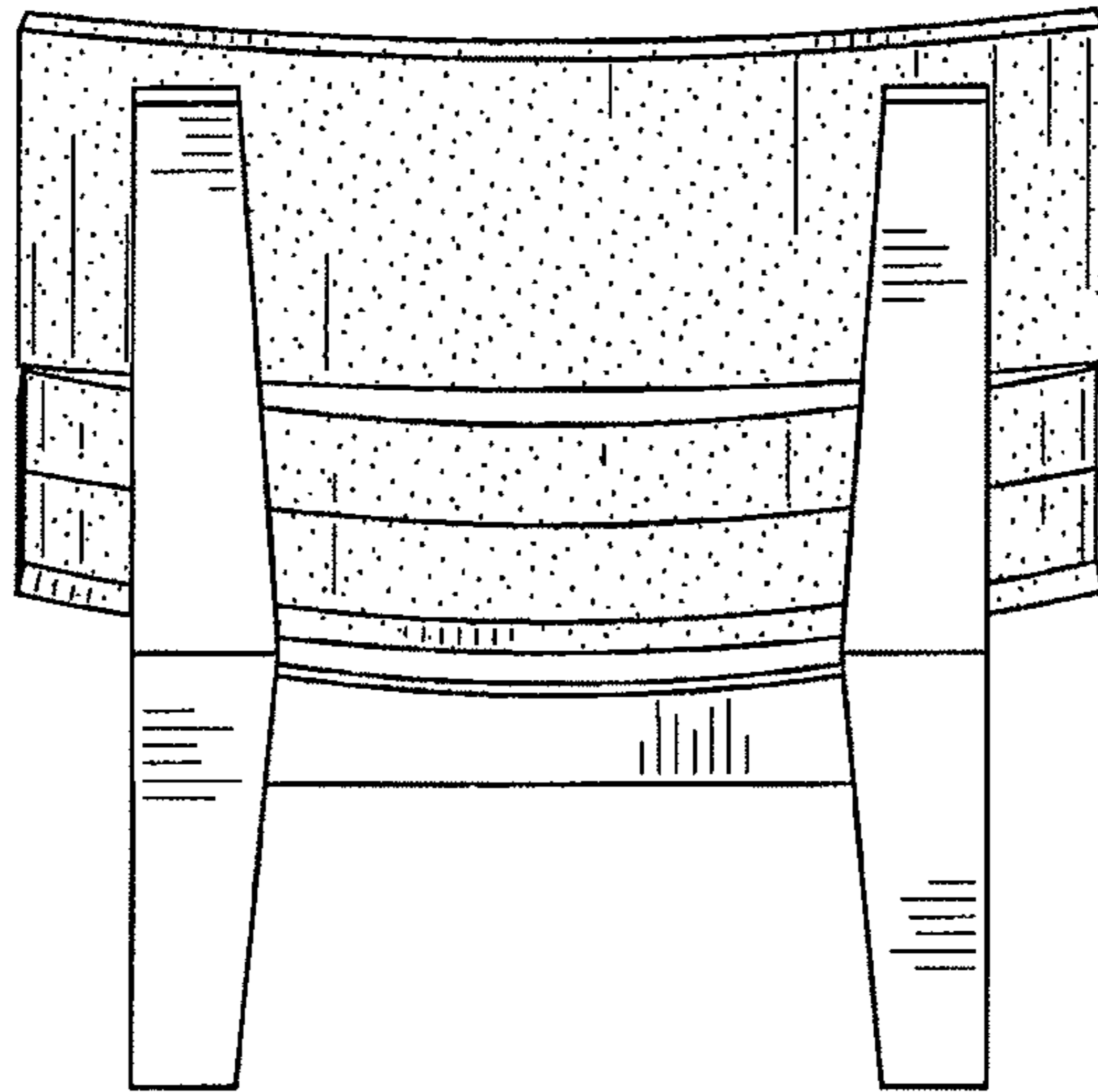

FIG. 11

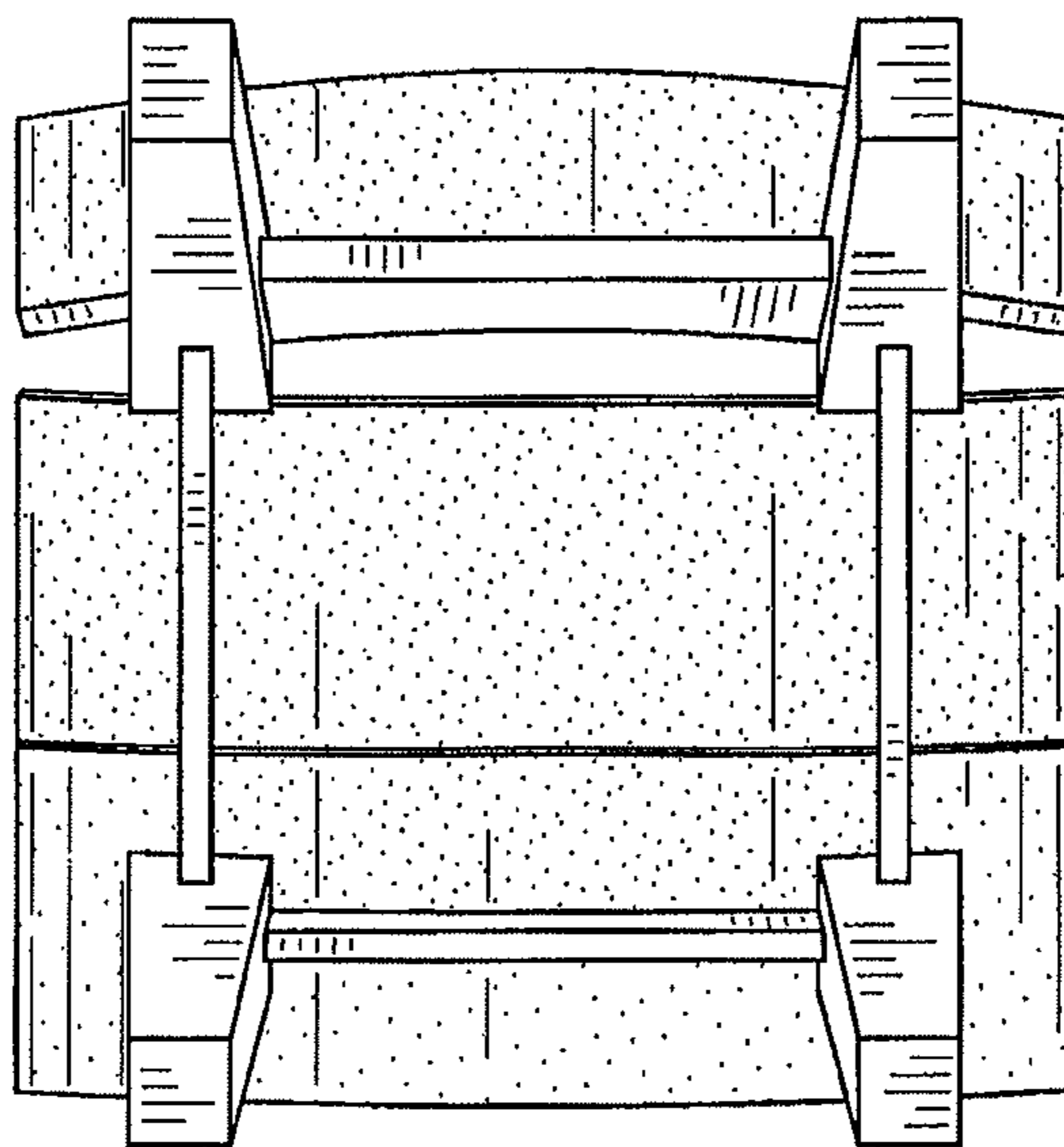

FIG. 12