



US00D704326S

(12) **United States Design Patent**
Formica et al.

(10) **Patent No.:** **US D704,326 S**
(45) **Date of Patent:** **** May 6, 2014**

(54) **POSITIVE AIRWAY PRESSURE (PAP)
DELIVERY DEVICE**

(75) Inventors: **Justin John Formica**, Voyager Point (AU); **Jose Ignacio Romagnoli**, Redfern (AU); **Allan Freas Velzy**, Burlingame, CA (US); **Michael Murillo**, Menlo Park, CA (US); **Michael Stephen Cheung**, Burlingame, CA (US); **Thomas M. Dair**, New York City, NY (US)

(73) Assignee: **ResMed Limited**, Bella Vista (AU)

(**) Term: **14 Years**

(21) Appl. No.: **29/410,998**

(22) Filed: **Jan. 13, 2012**

(51) **LOC (10) Cl.** **29-02**

(52) **U.S. Cl.**
USPC **D24/110.1**

(58) **Field of Classification Search**
USPC D24/110, 110.1, 110.4, 110.5;
128/203.12, 204.18, 205.25, 207.13,
128/207.17, 207.18

See application file for complete search history.

(56) **References Cited**

U.S. PATENT DOCUMENTS

D424,689 S * 5/2000 Monnich D24/110.5
6,302,102 B1 * 10/2001 Giroux et al. 128/201.11

(Continued)

Primary Examiner — Ian Simmons

Assistant Examiner — Richelle G Shelton

(74) *Attorney, Agent, or Firm* — Nixon & Vanderhye P.C.

(57) **CLAIM**

The ornamental design for a positive airway pressure (PAP) delivery device, as shown and described.

DESCRIPTION

FIG. 1 is a front perspective view of a positive airway pressure (PAP) delivery device according to a first embodiment of our new ornamental design;

FIG. 2 is a front view thereof;
FIG. 3 is a rear view thereof;
FIG. 4 is a top view thereof;
FIG. 5 is a bottom view thereof;
FIG. 6 is a right side view thereof;
FIG. 7 is a left side view thereof;
FIG. 8 is detail 8 of FIG. 1 shown on an enlarged scale;
FIG. 9 is a front perspective view of a positive airway pressure (PAP) delivery device according to a second embodiment of our new ornamental design;
FIG. 10 is a front view thereof;
FIG. 11 is a rear view thereof;
FIG. 12 is a top view thereof;
FIG. 13 is a bottom view thereof;
FIG. 14 is a right side view thereof;
FIG. 15 is a left side view thereof;
FIG. 16 is reference view thereof, similar to FIG. 9, but shown with an unclaimed model patient's head where the tube wraps around the side of the patient's head;
FIG. 17 is a front perspective view of a positive airway pressure (PAP) delivery device according to a third embodiment of our new ornamental design;
FIG. 18 is a front view thereof;
FIG. 19 is a rear view thereof;
FIG. 20 is a top view thereof;
FIG. 21 is a bottom view thereof;
FIG. 22 is a right side view thereof;
FIG. 23 is a left side view thereof;
FIG. 24 is a front perspective view of a positive airway pressure (PAP) delivery device according to a fourth embodiment of our new ornamental design;
FIG. 25 is a front view thereof;
FIG. 26 is a rear view thereof;
FIG. 27 is a top view thereof;
FIG. 28 is a bottom view thereof;
FIG. 29 is a right side view thereof;
FIG. 30 is a left side view thereof; and,
FIG. 31 is reference view thereof, similar to FIG. 24, but shown with an unclaimed model patient's head where the tube wraps around the side of the patient's head.
The broken line showing at the end of the tube and in the interior of the mask is included for the purpose of illustrating environmental structure and forms no part of the claimed design.
The use of different shading and stippling, e.g., FIGS. 1-8, has been used to indicate contrast.

1 Claim, 25 Drawing Sheets

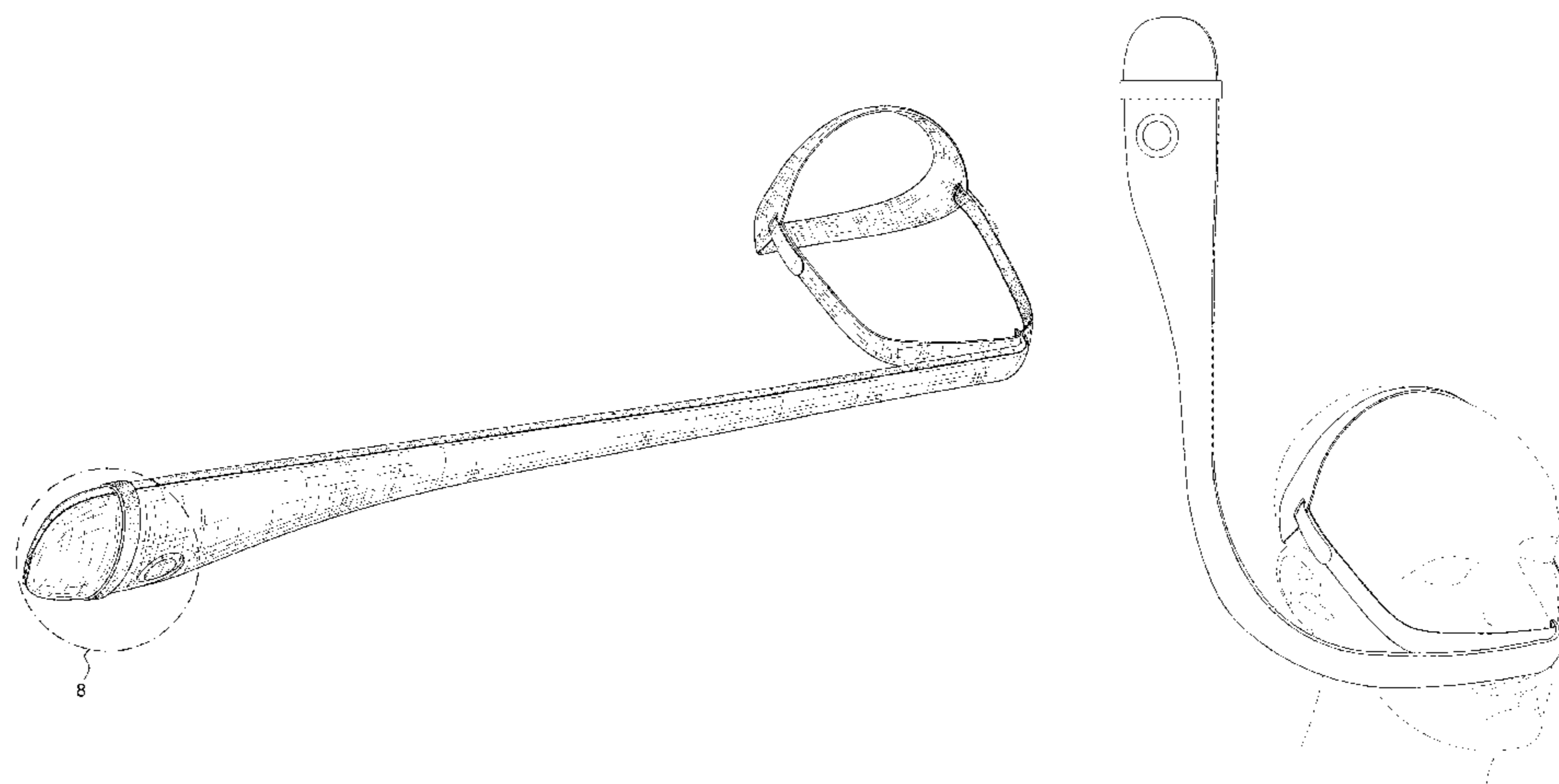

(56)

References Cited

U.S. PATENT DOCUMENTS

D559,977 S *	1/2008	Ball	D24/110.4				
2009/0217929 A1 *	9/2009	Kwok et al.	128/204.18				
2009/0223518 A1 *	9/2009	Kwok et al.	128/205.25				
2010/0132716 A1 *	6/2010	Selvarajan et al.	128/207.18				
2010/0229868 A1 *	9/2010	Rummery et al.	128/205.25				
2010/0307502 A1 *	12/2010	Rummery et al.	128/205.25				

* cited by examiner

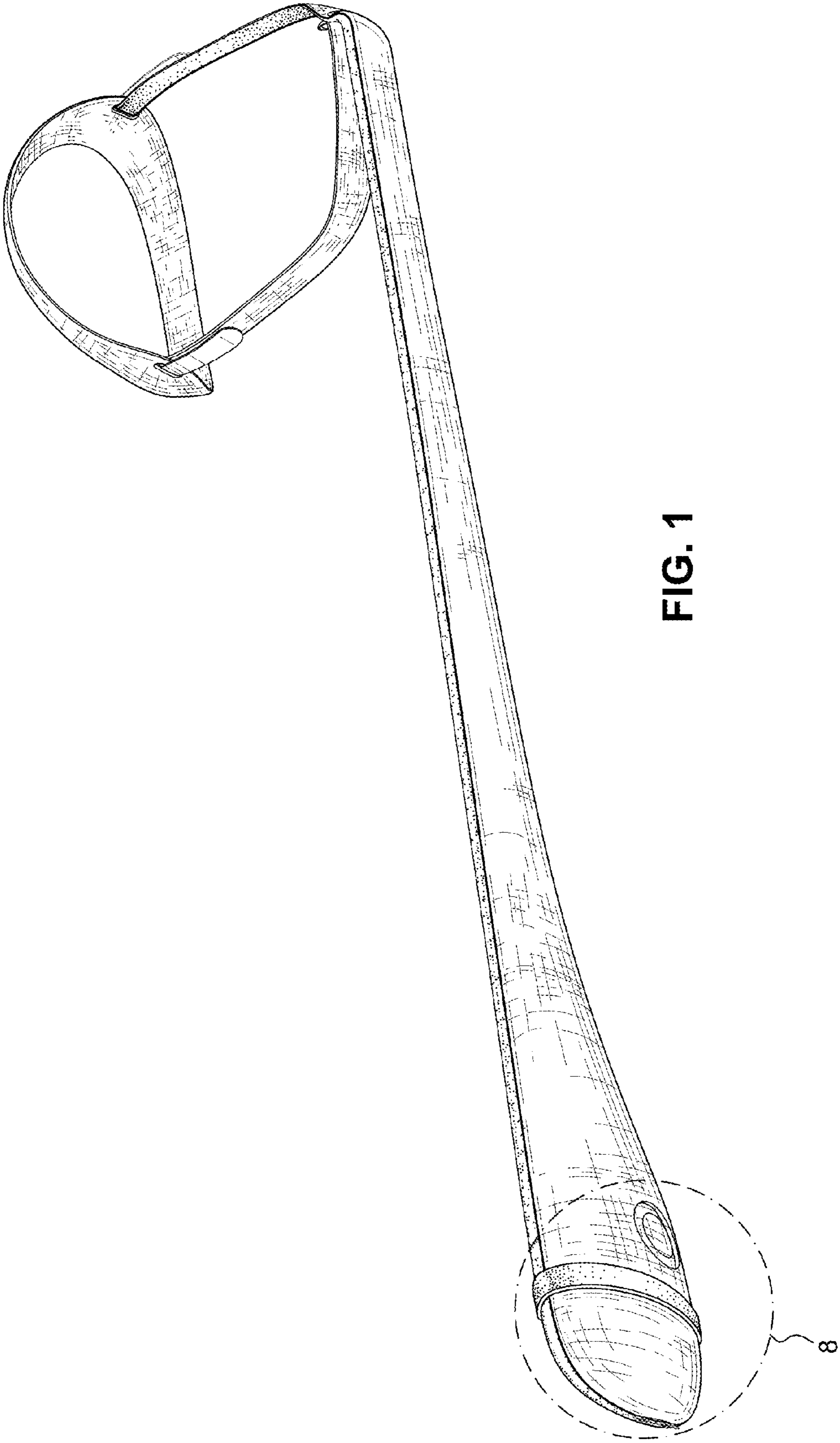

FIG. 1

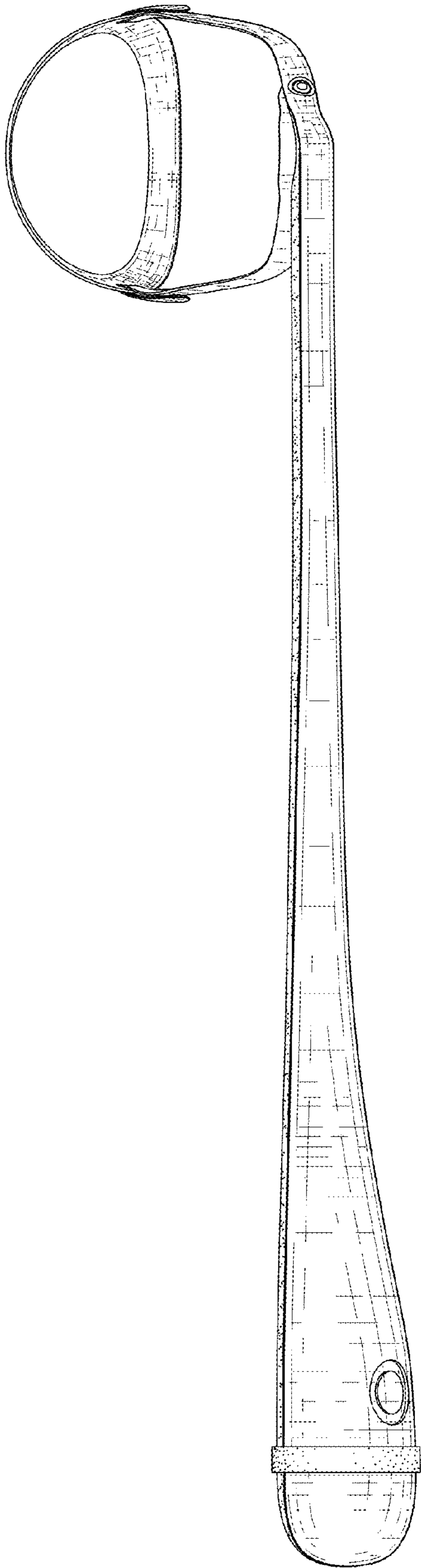

FIG. 2

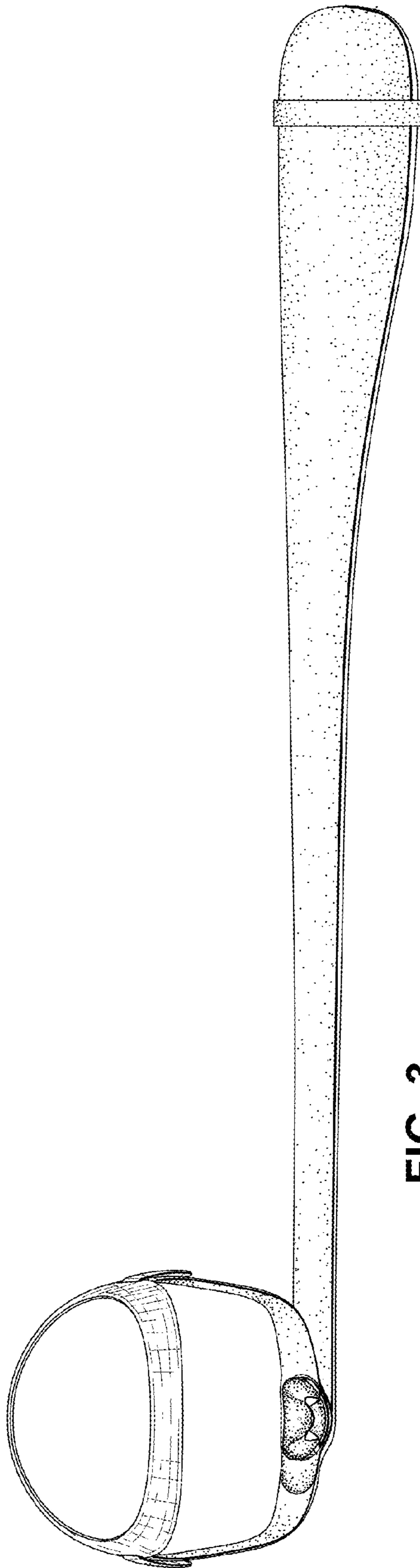

FIG. 3

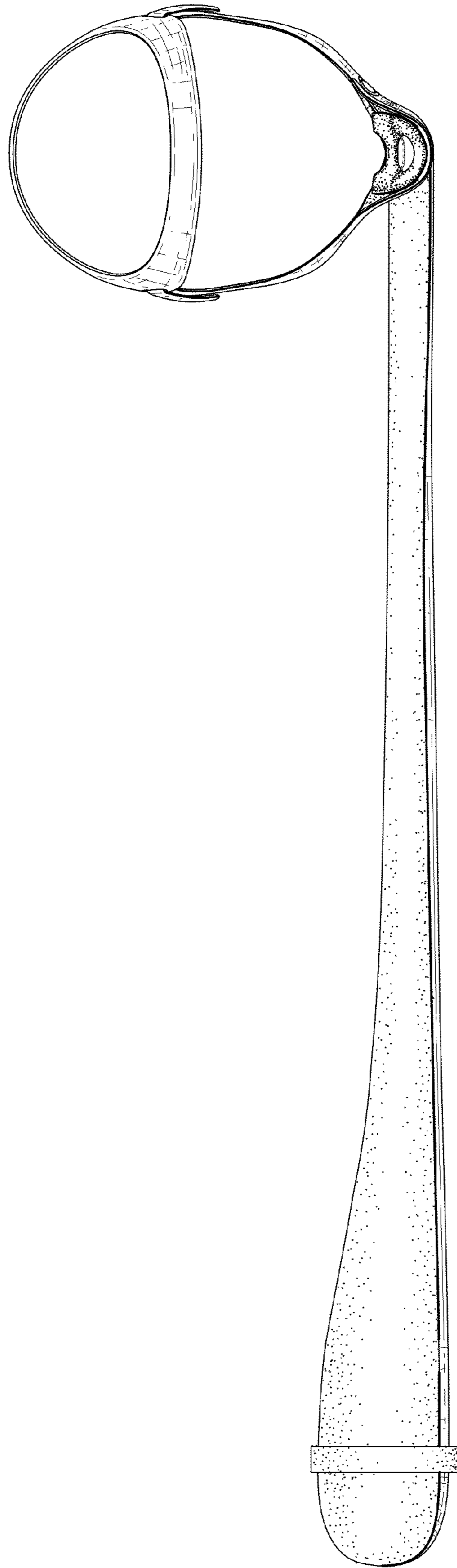

FIG. 4

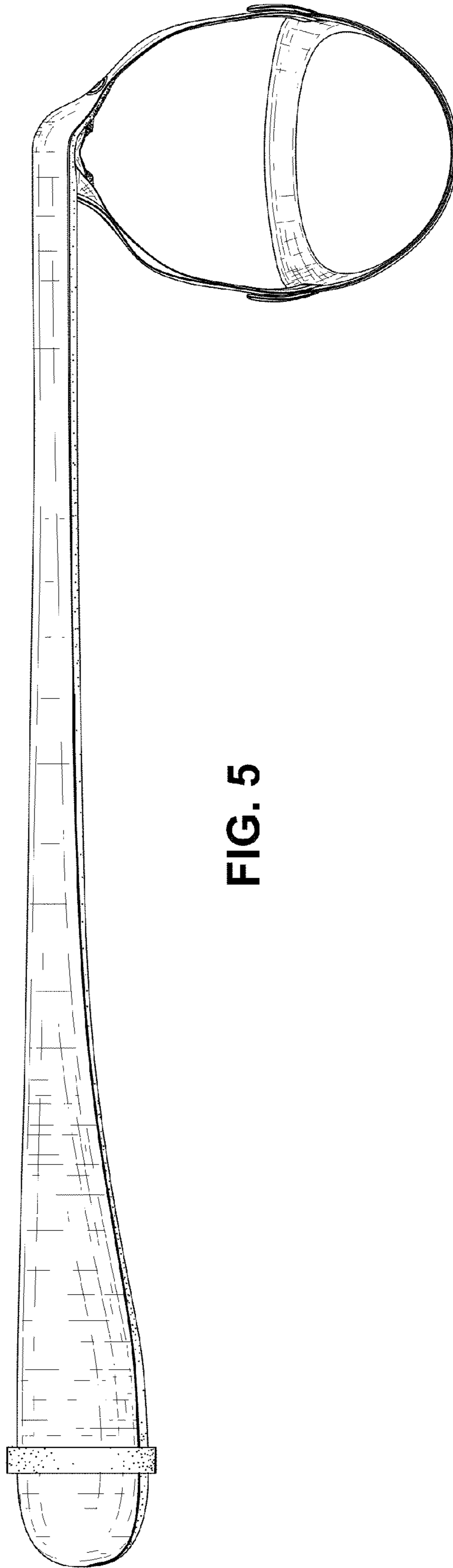

FIG. 5

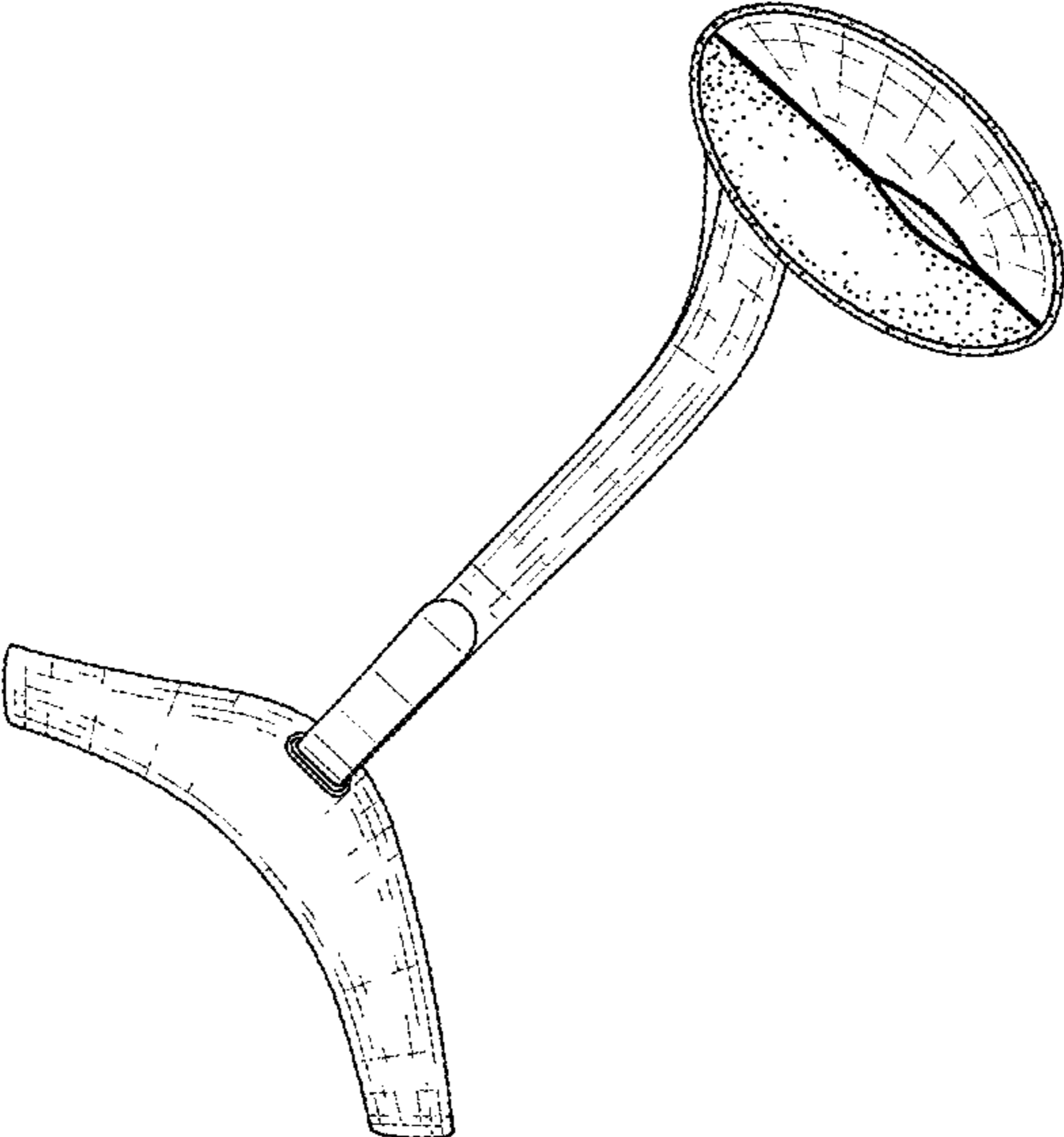

FIG. 7

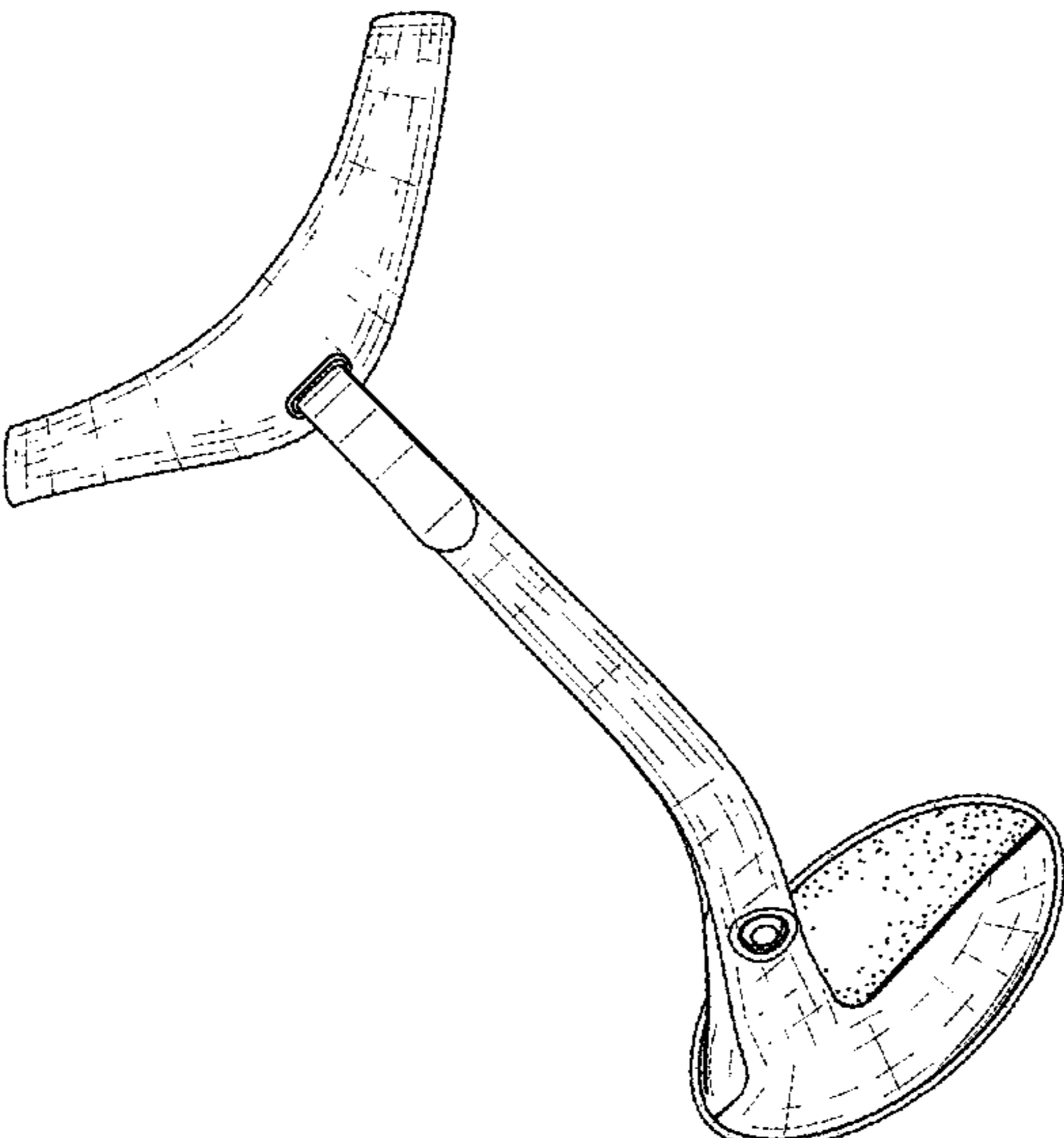

FIG. 6

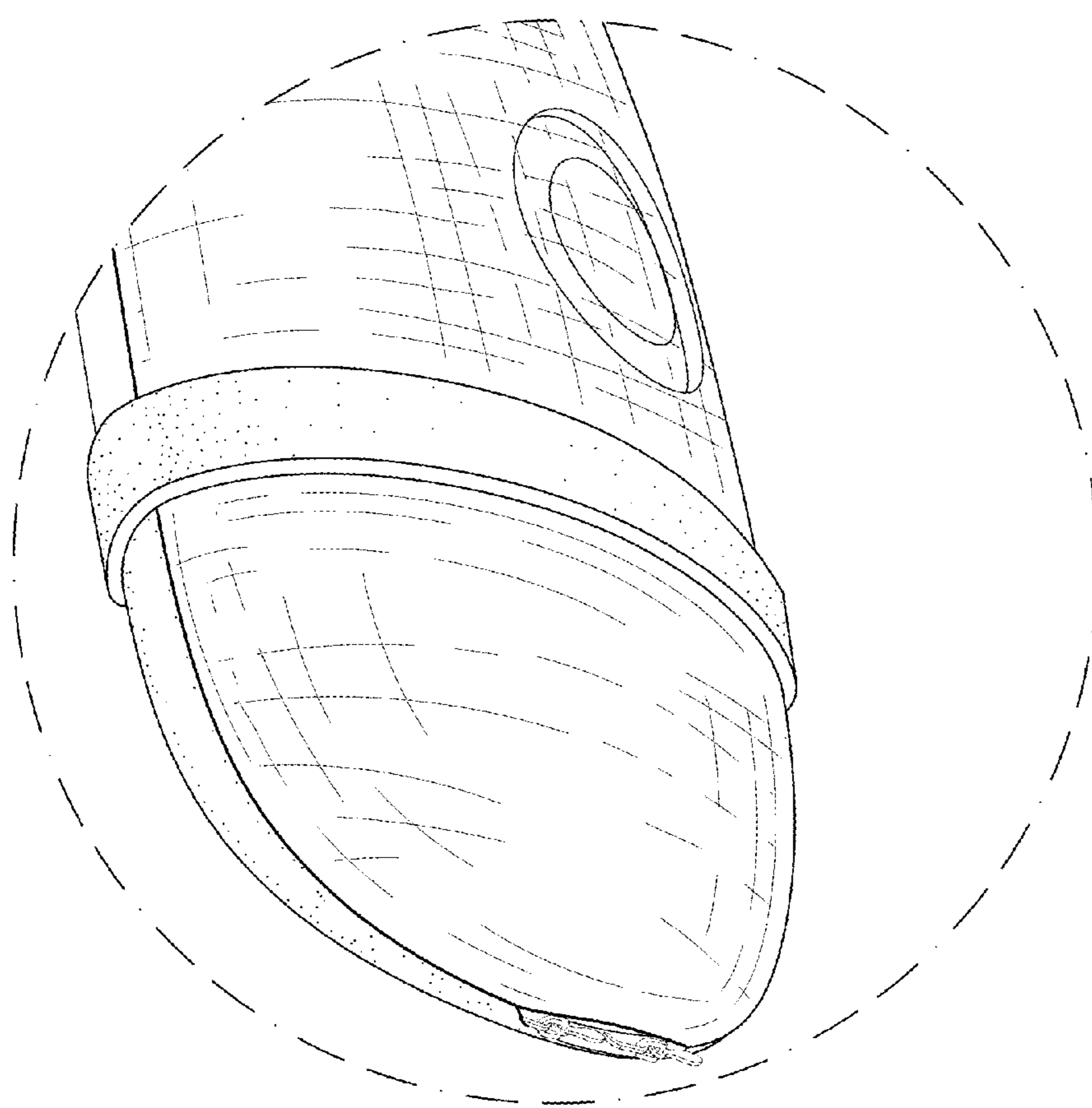

FIG. 8

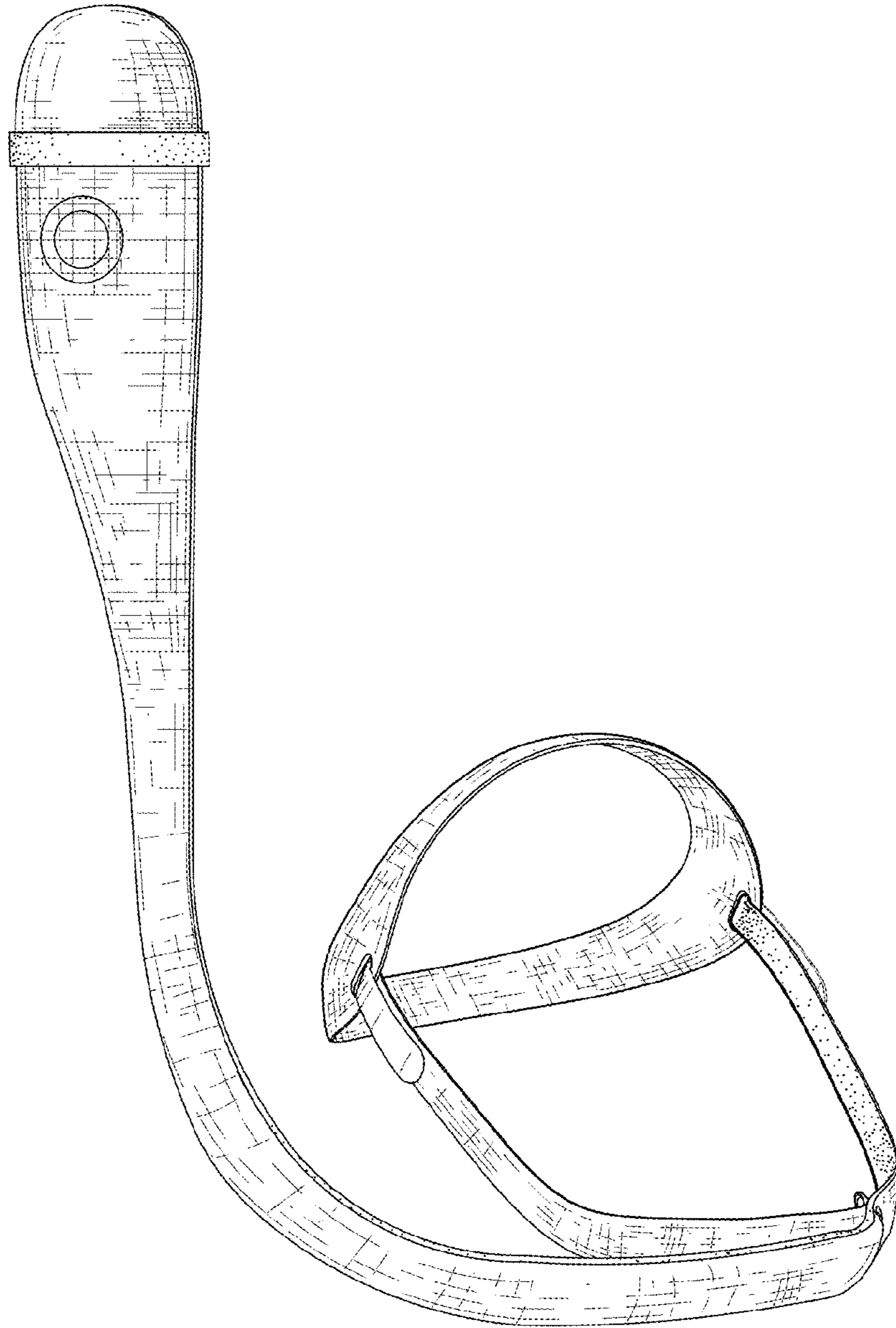

FIG. 9

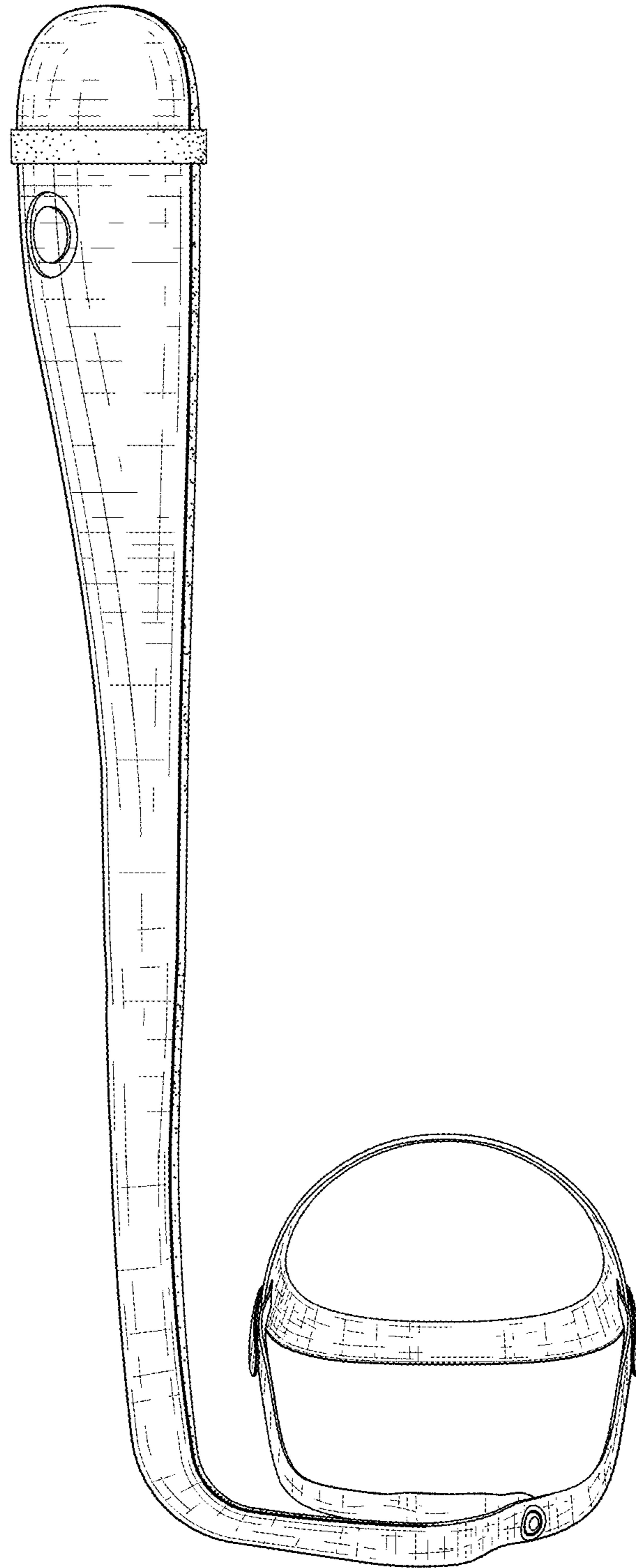

FIG. 10



FIG. 11

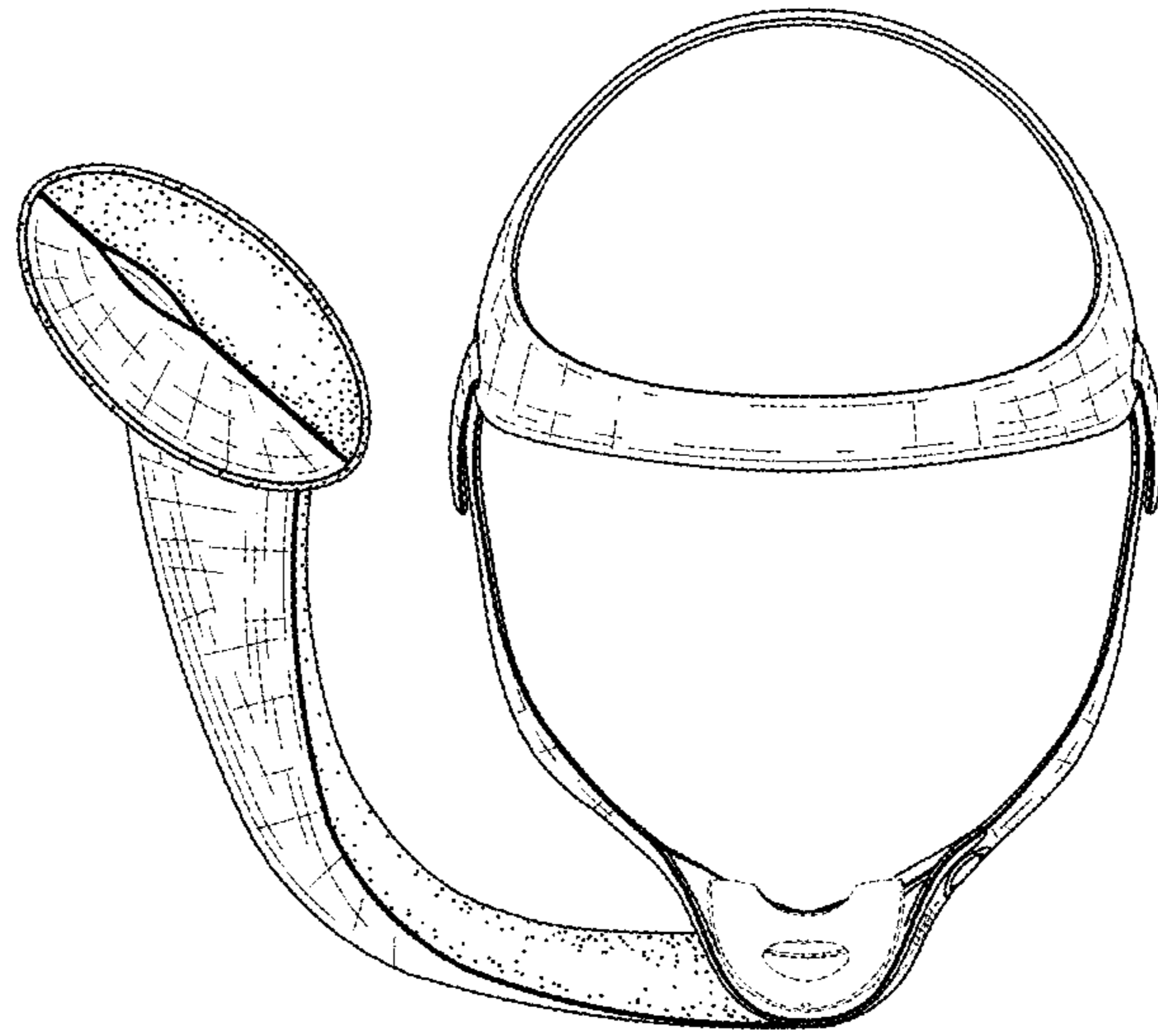

FIG. 12

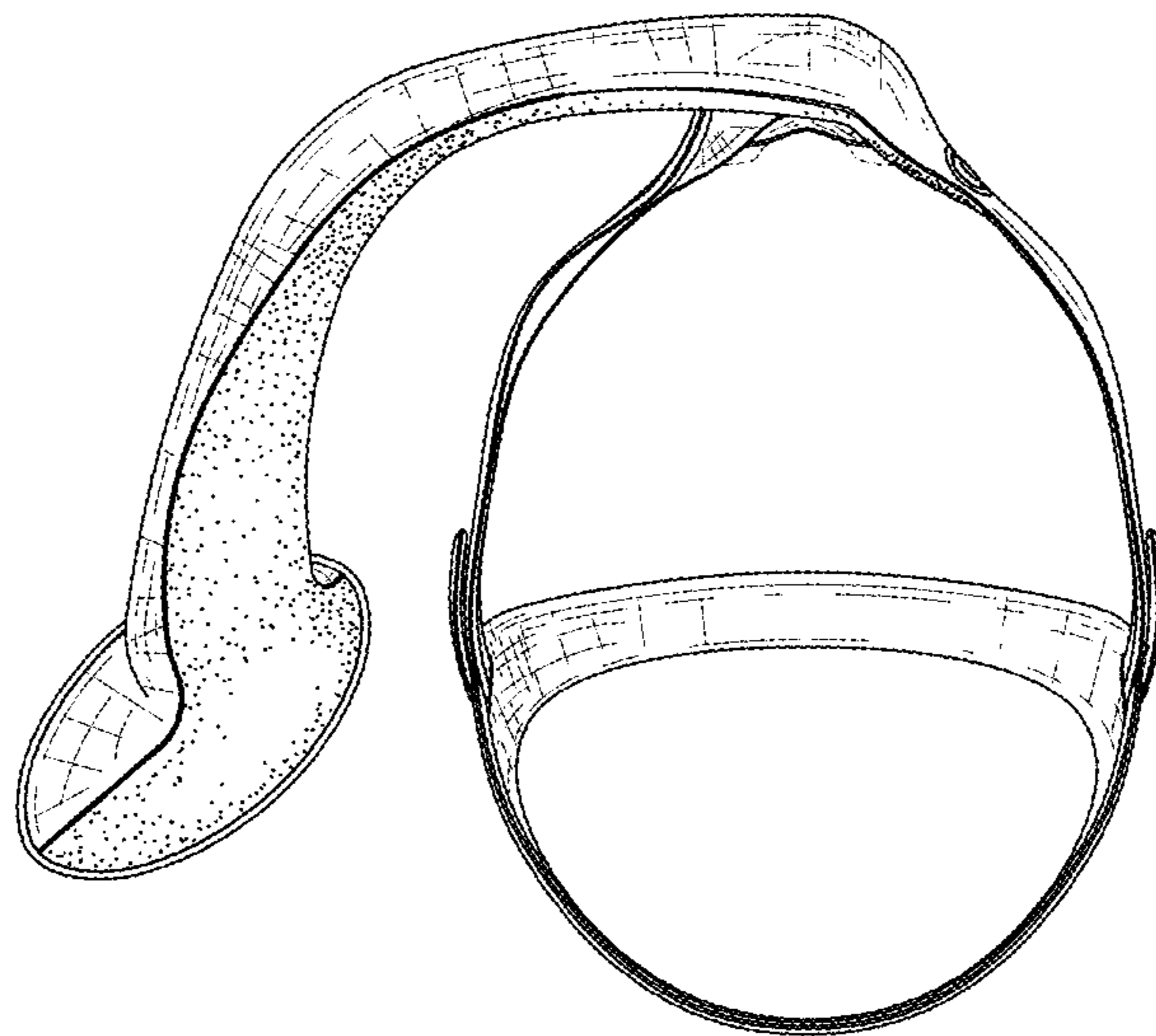

FIG. 13

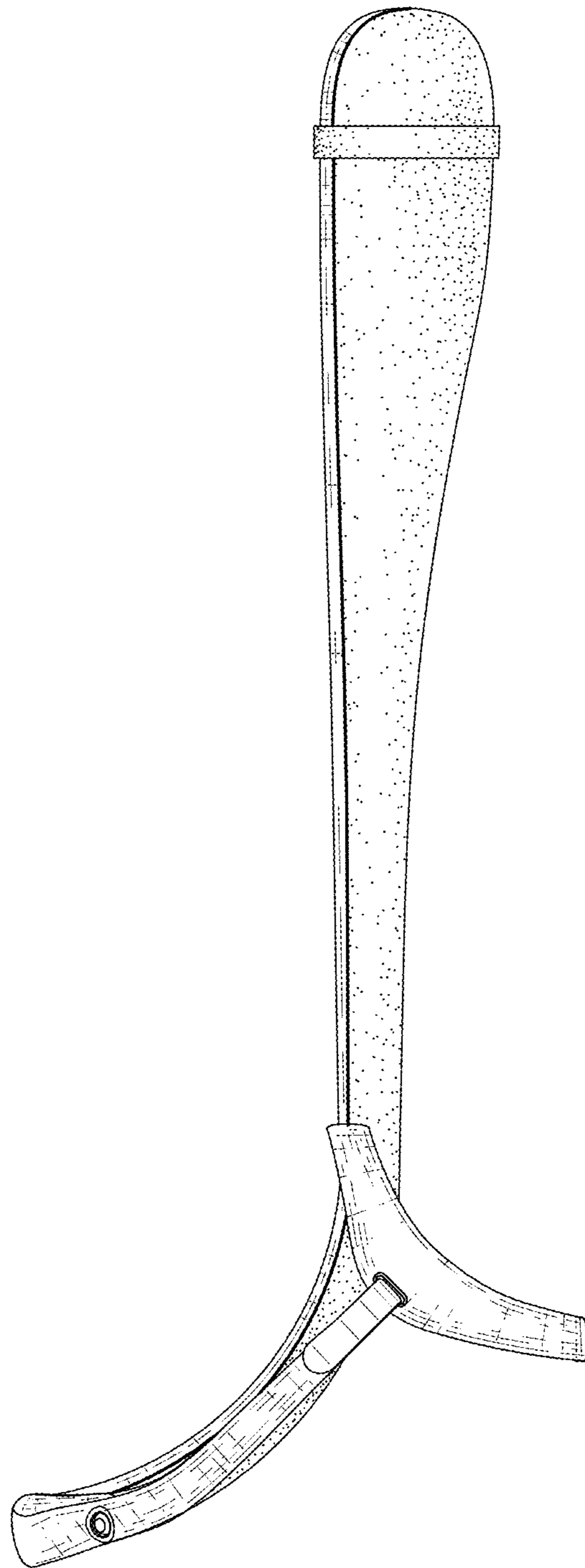

FIG. 14

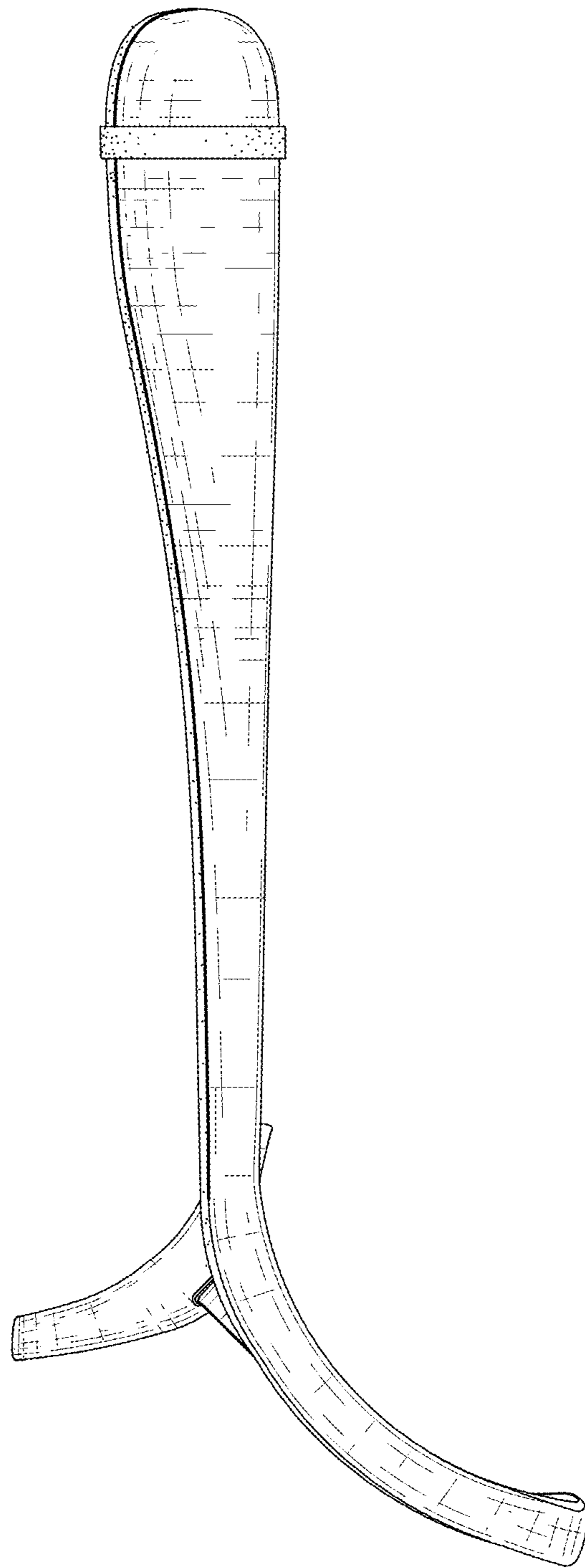

FIG. 15

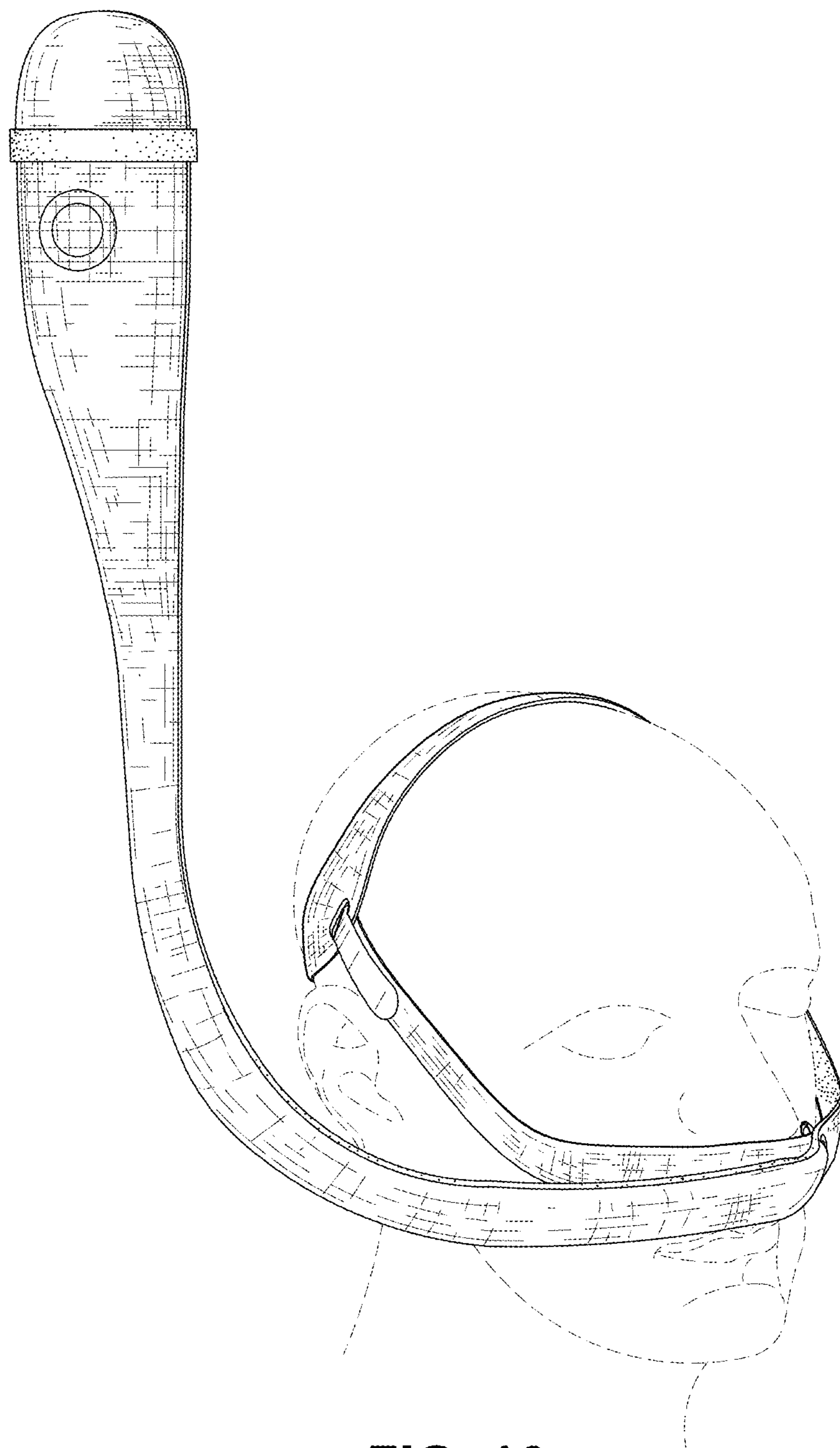

FIG. 16

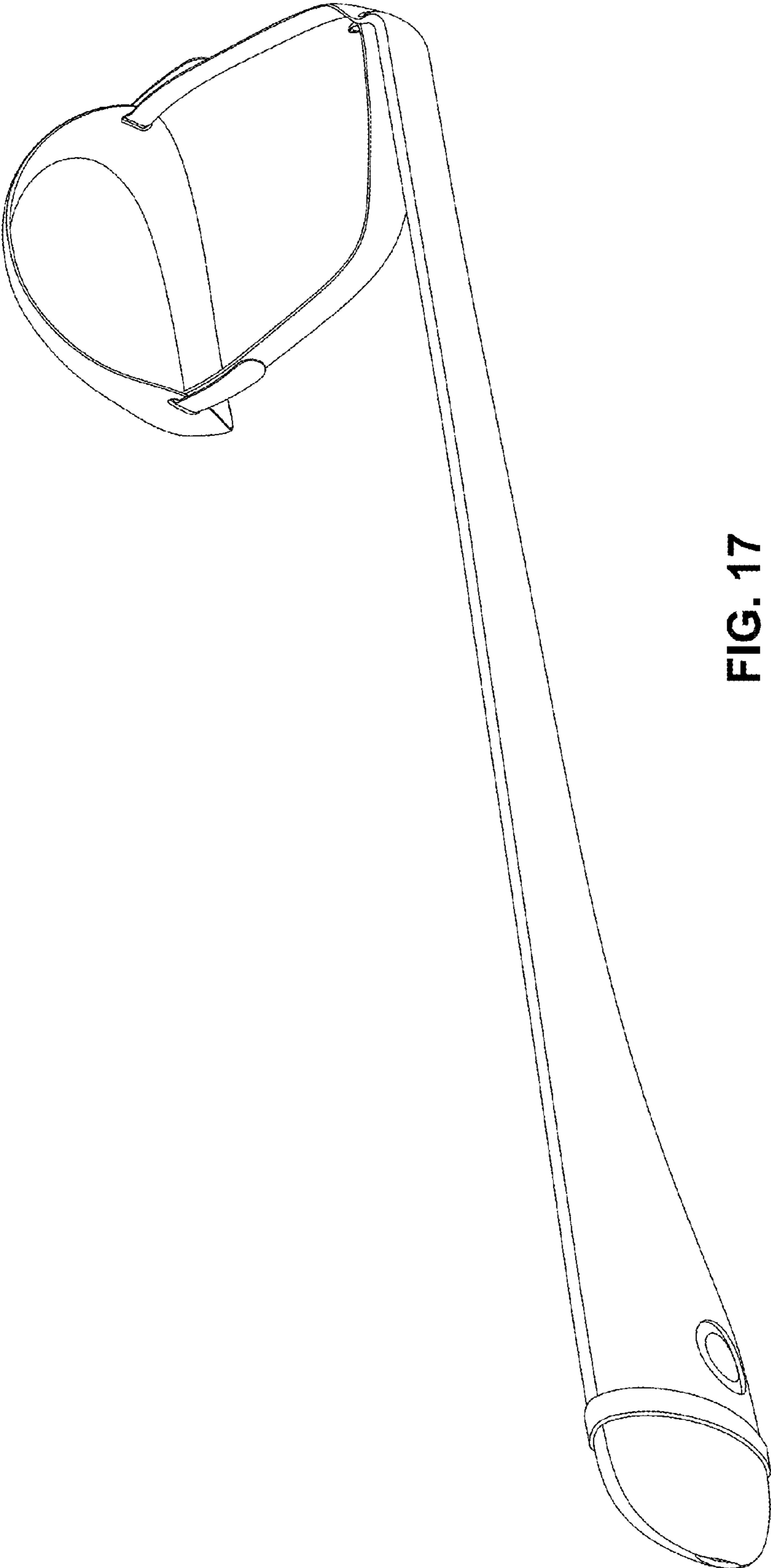

FIG. 17

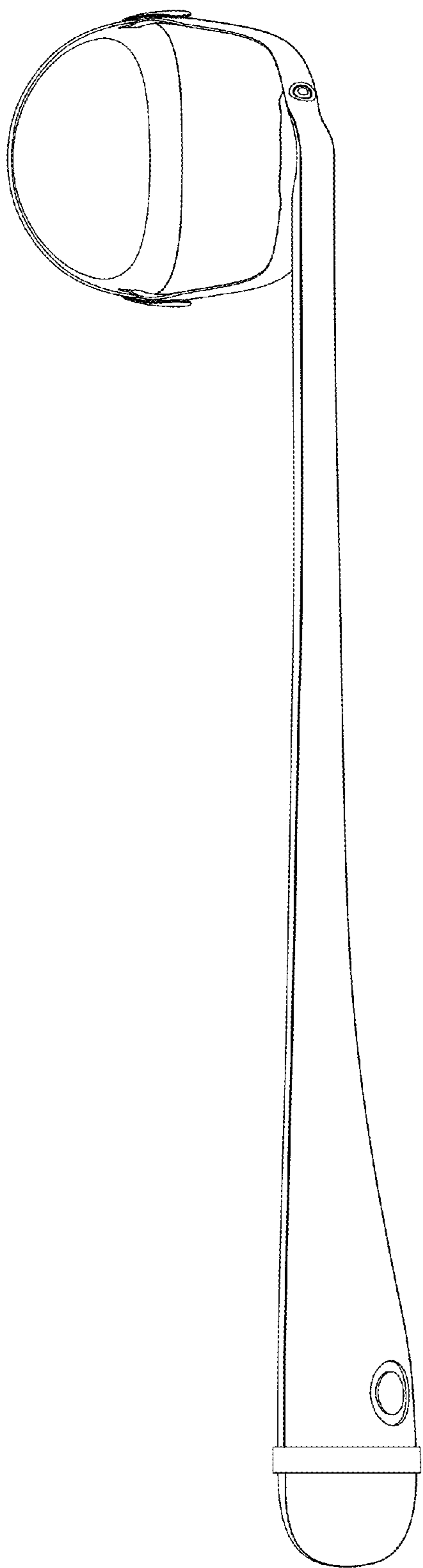

FIG. 18

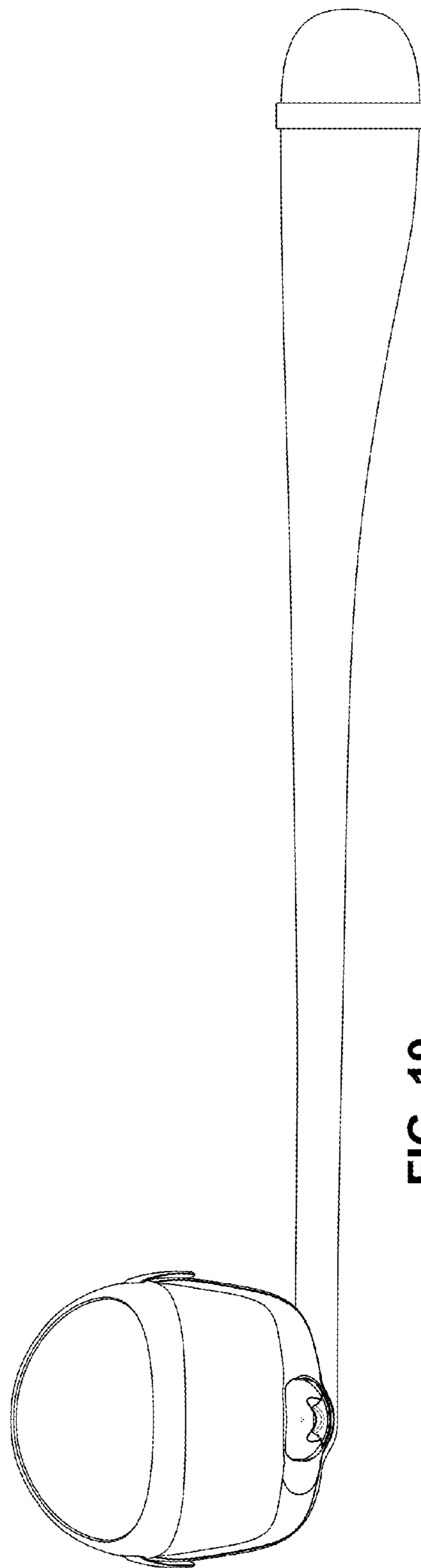

FIG. 19

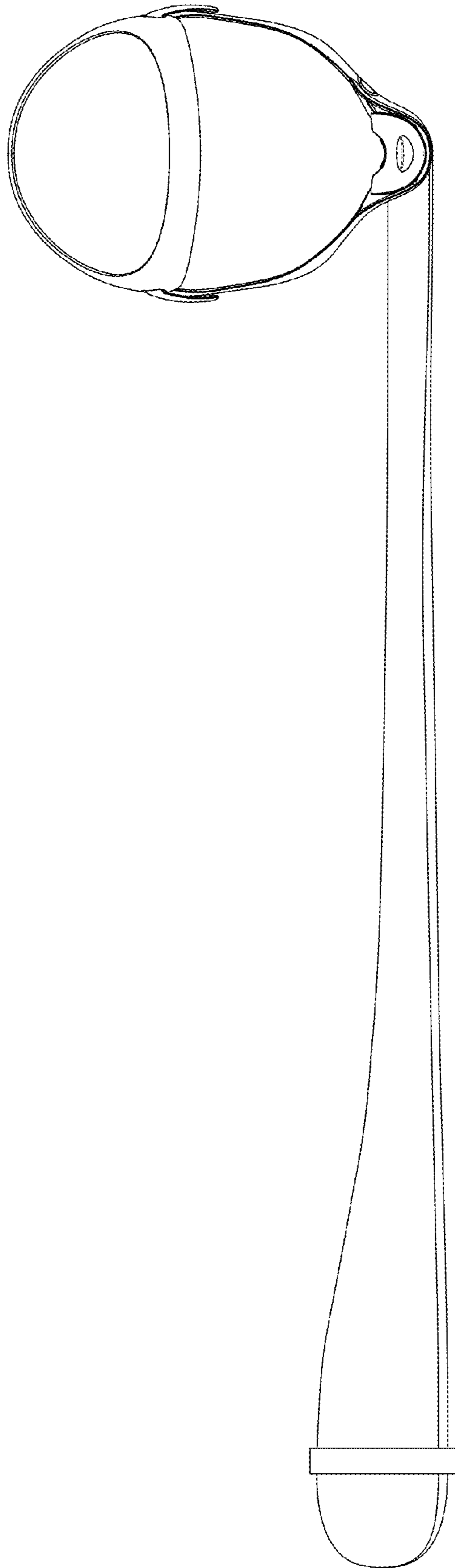

FIG. 20

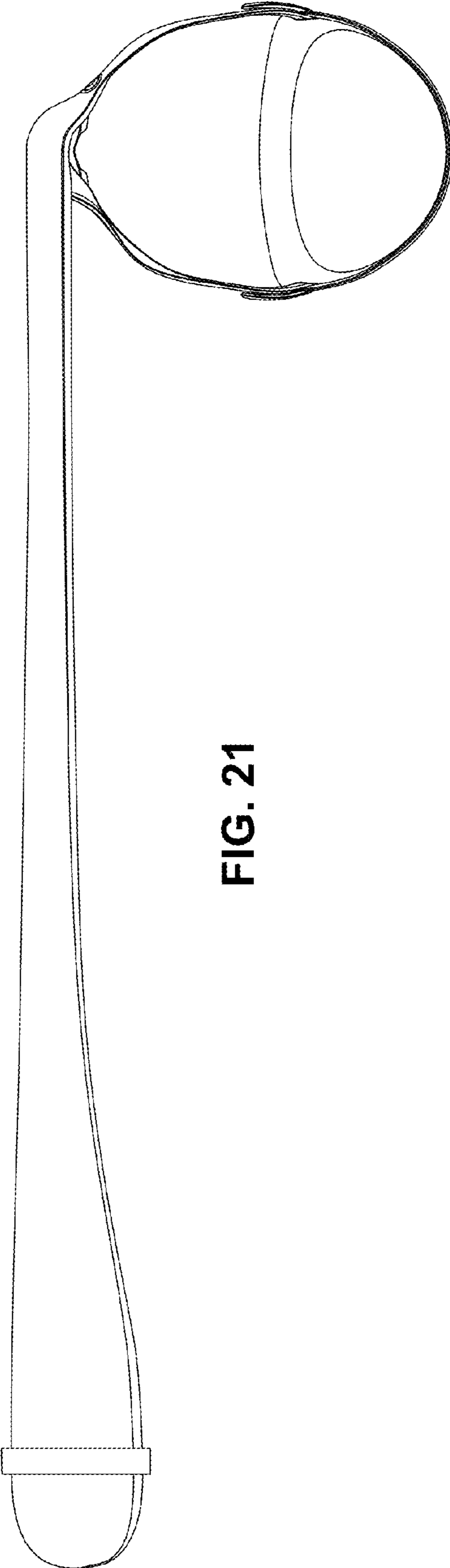

FIG. 21

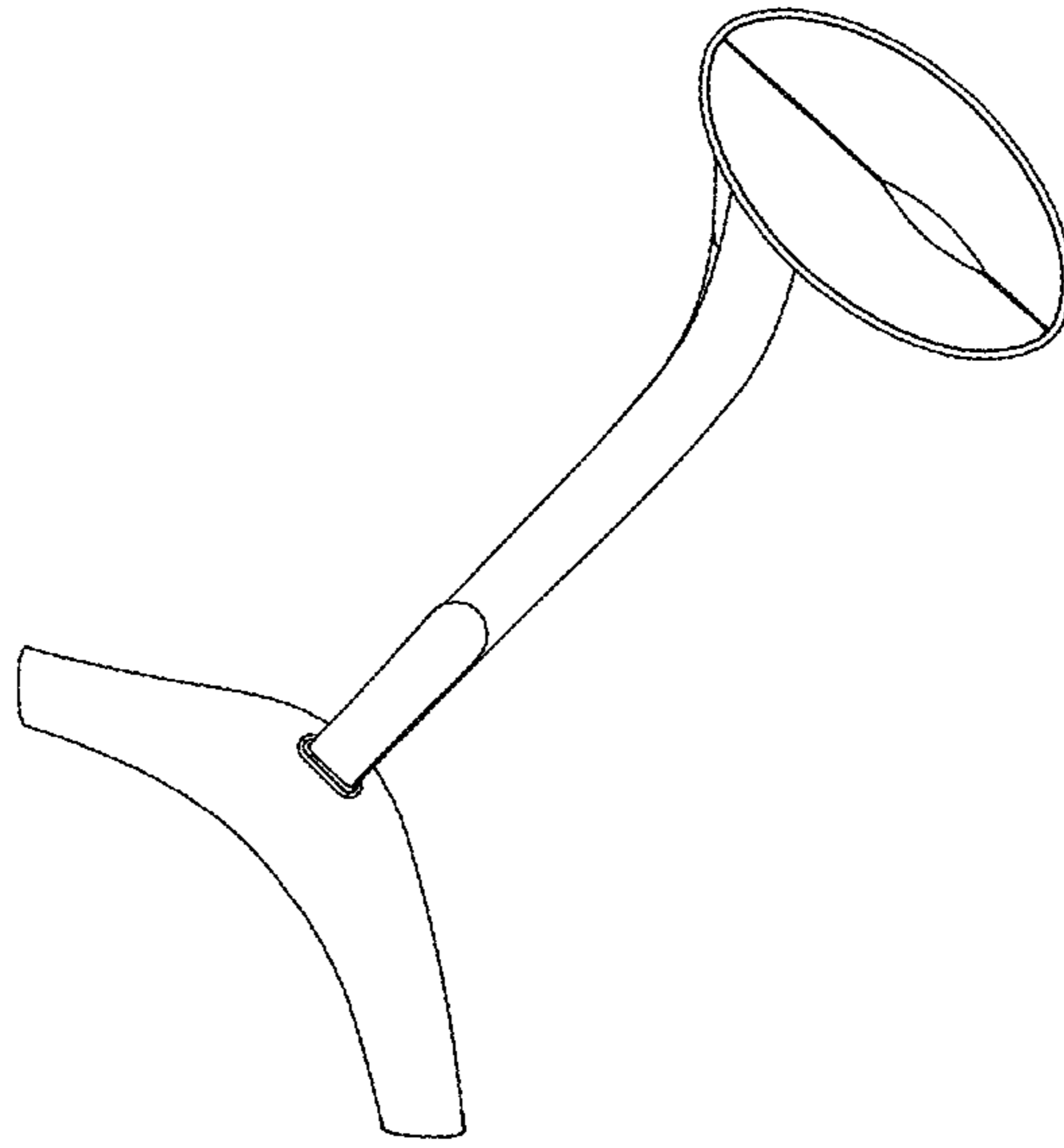

FIG. 23

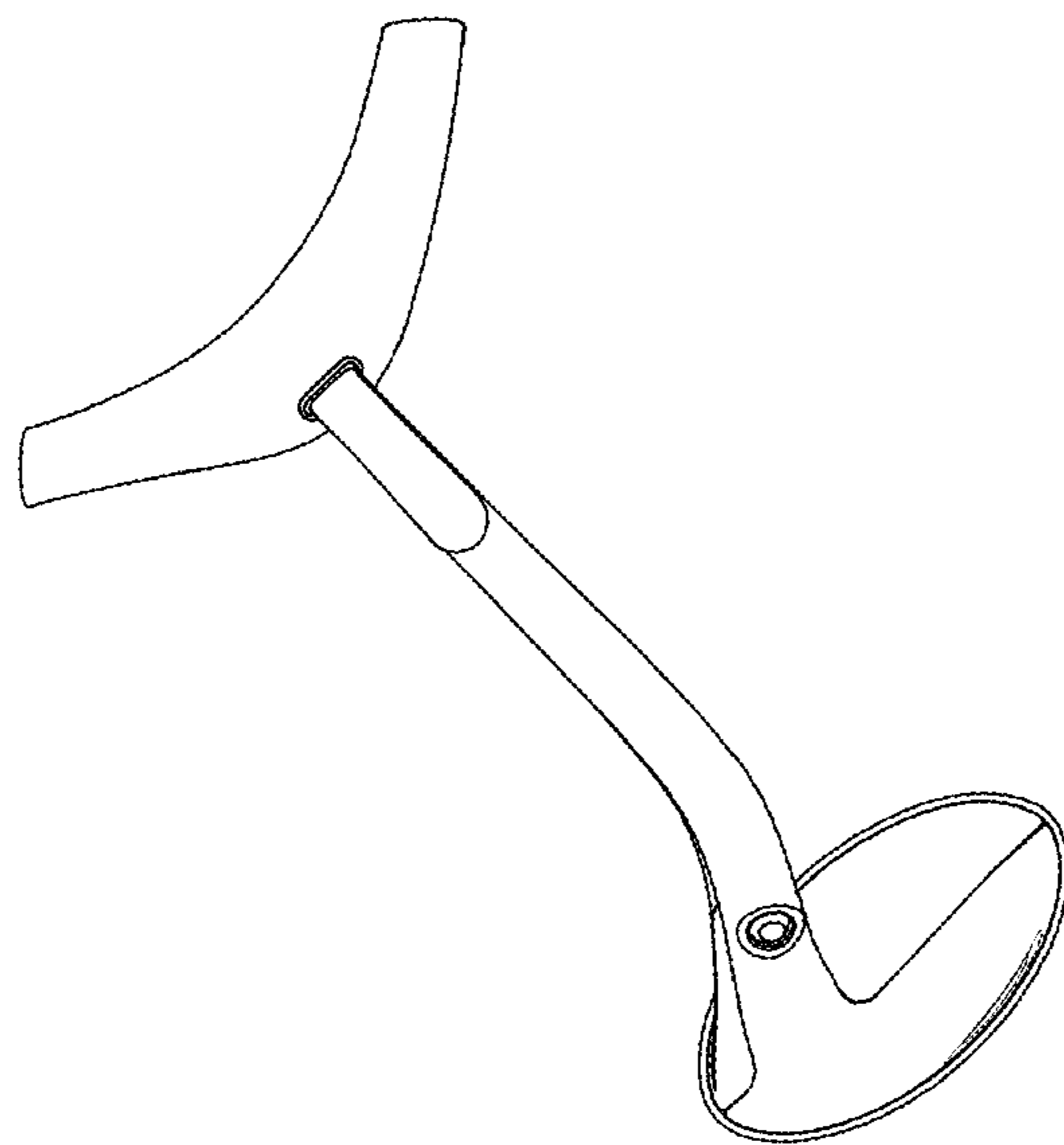

FIG. 22

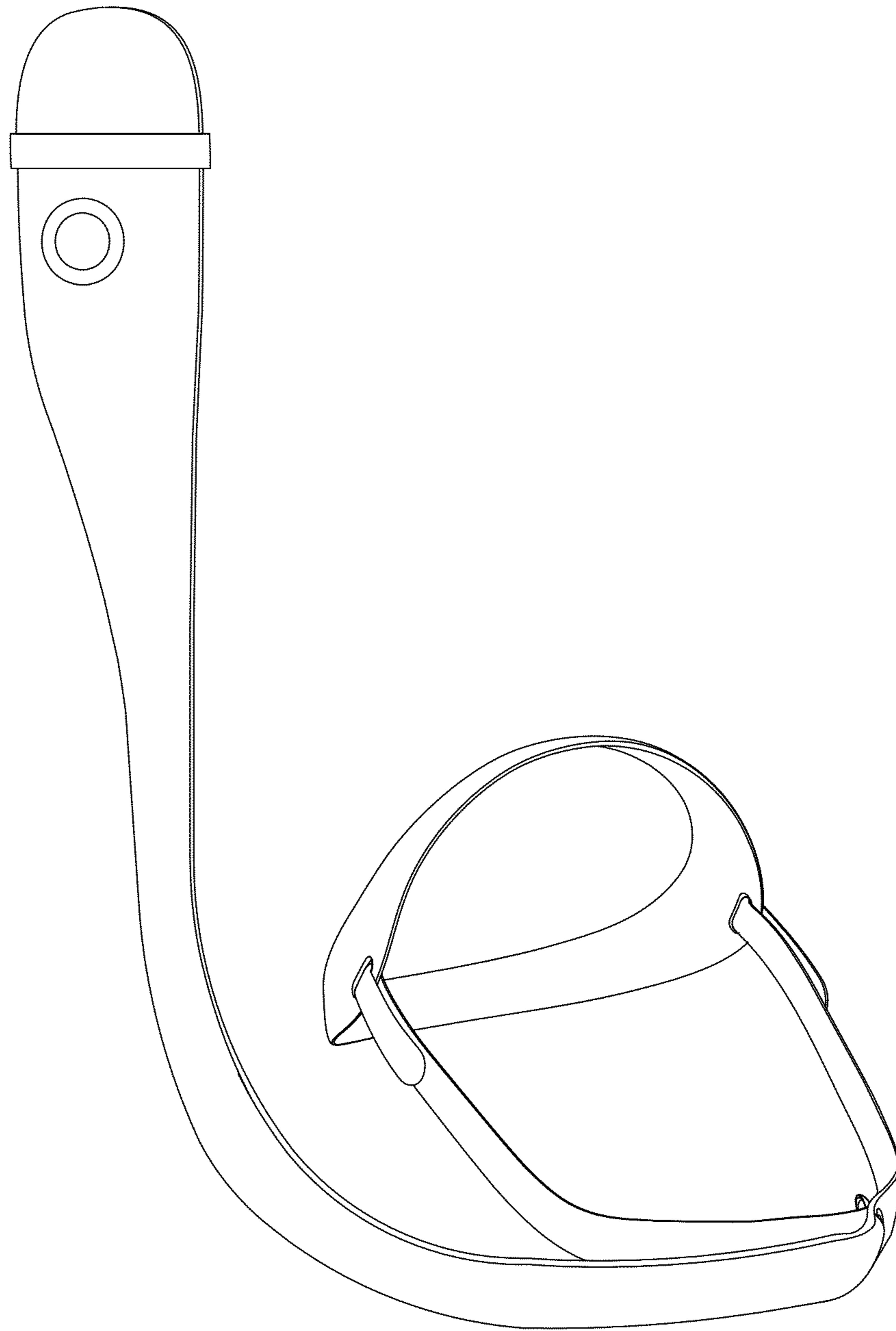

FIG. 24

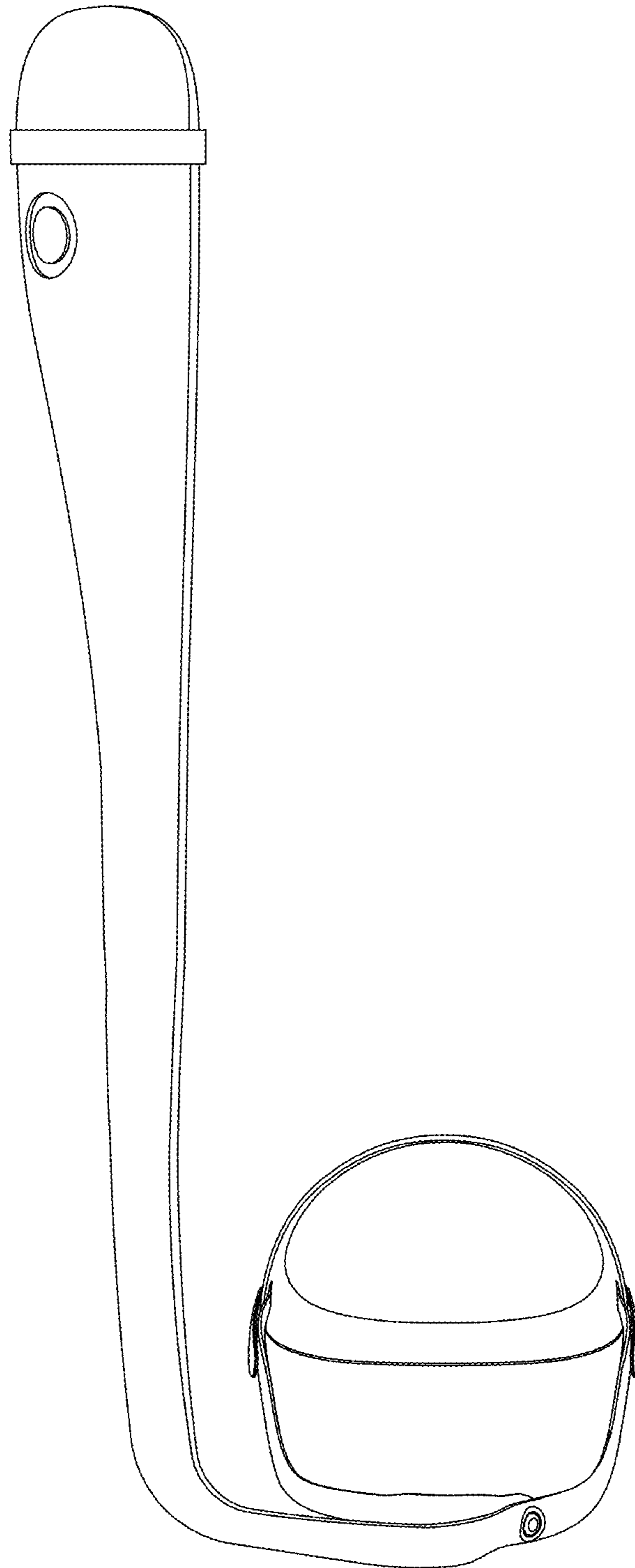

FIG. 25

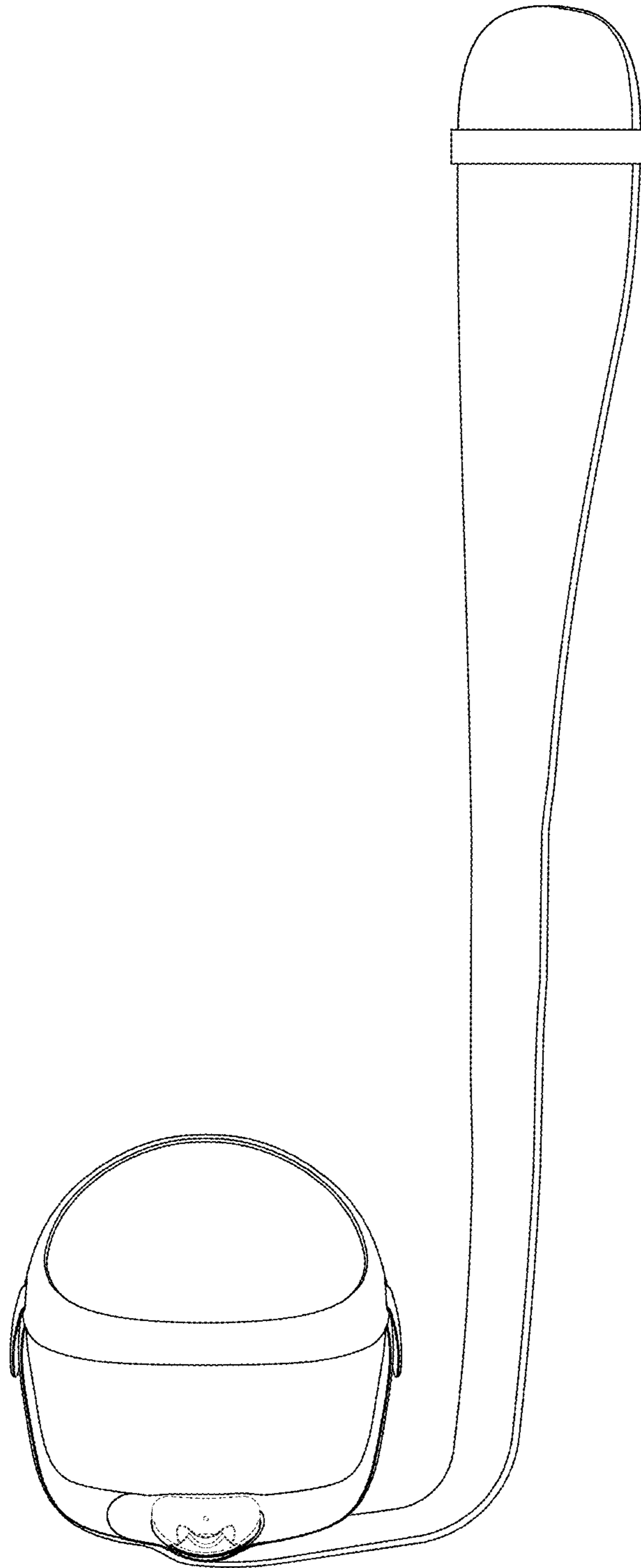

FIG. 26

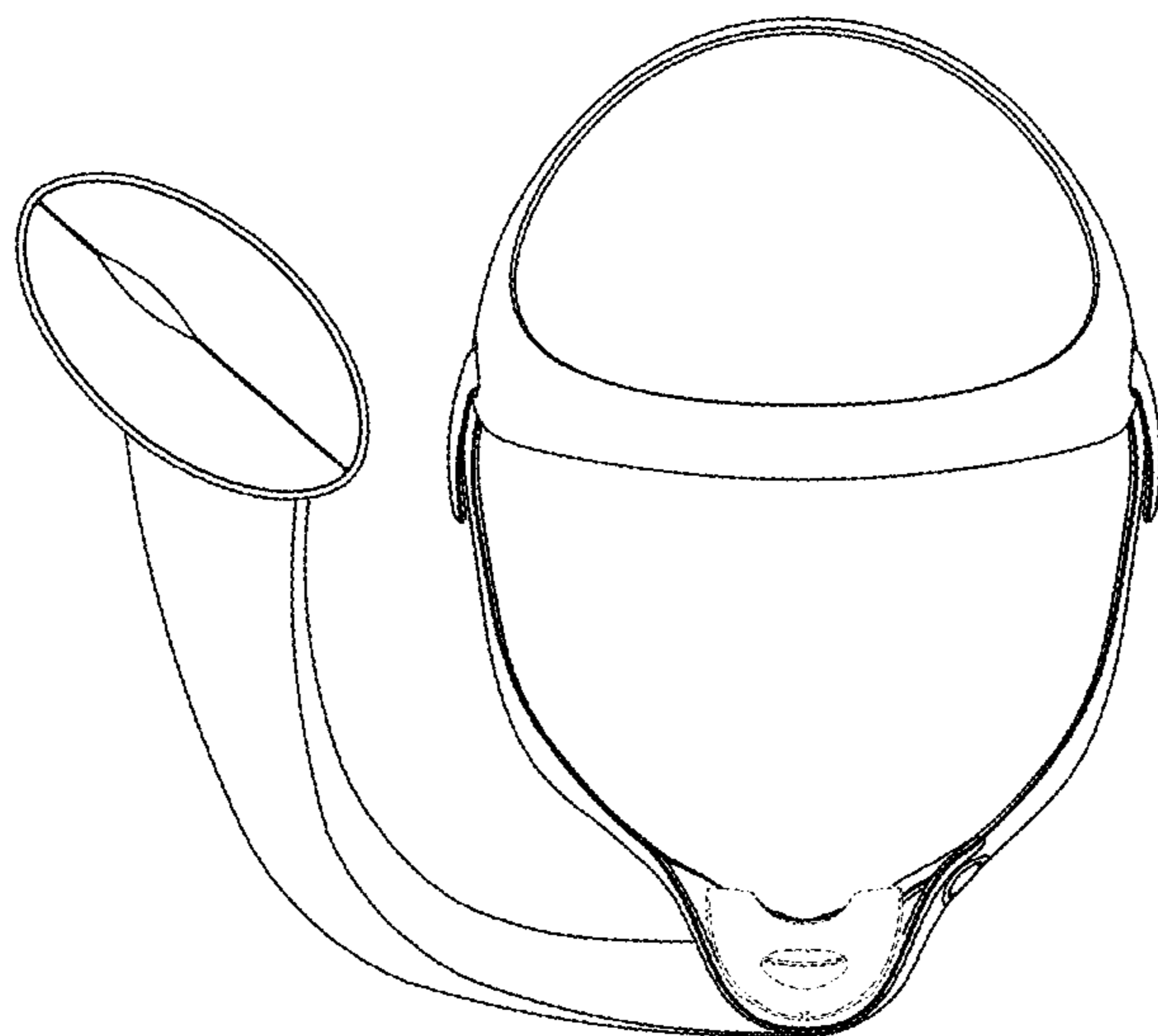

FIG. 27

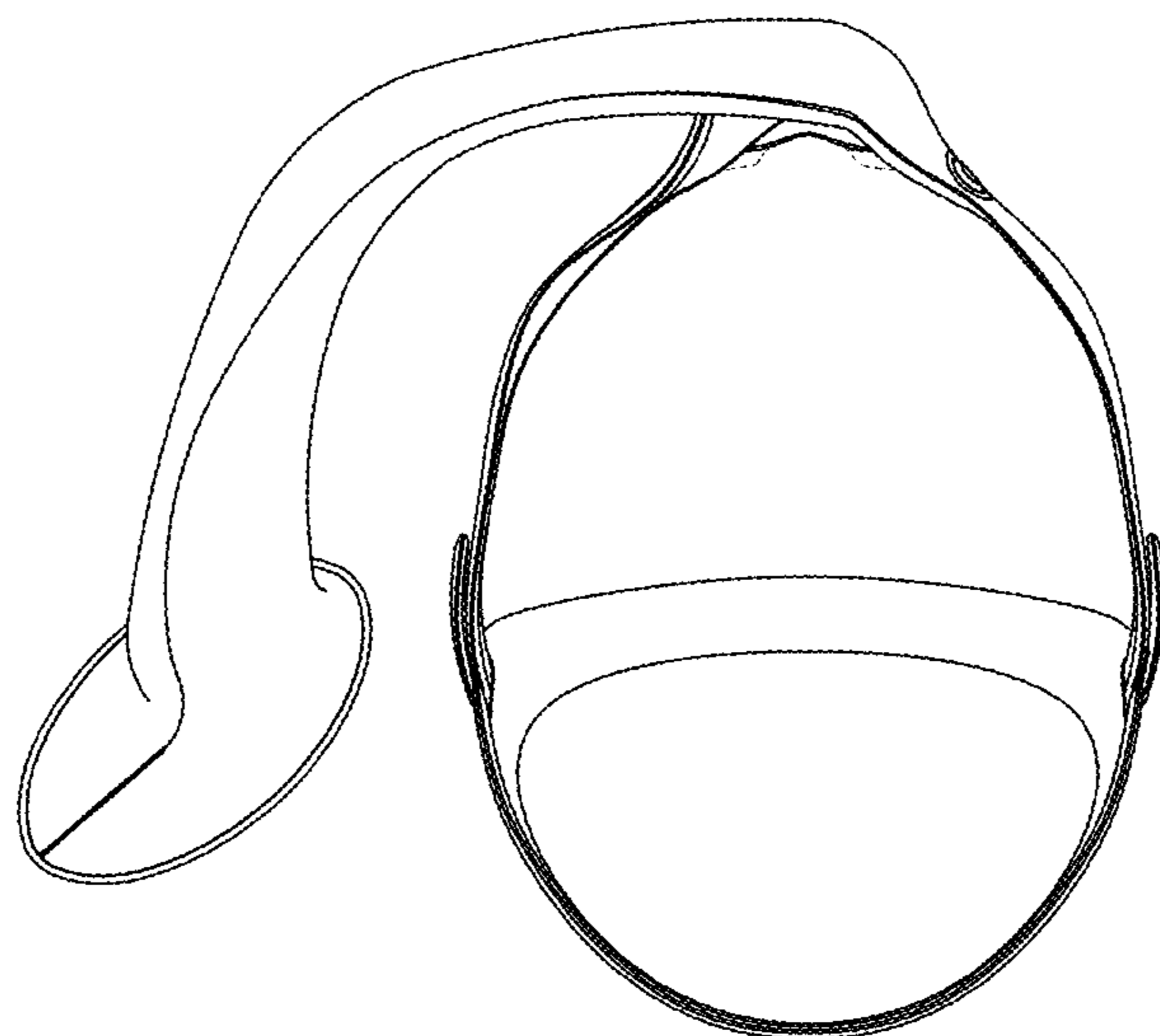

FIG. 28

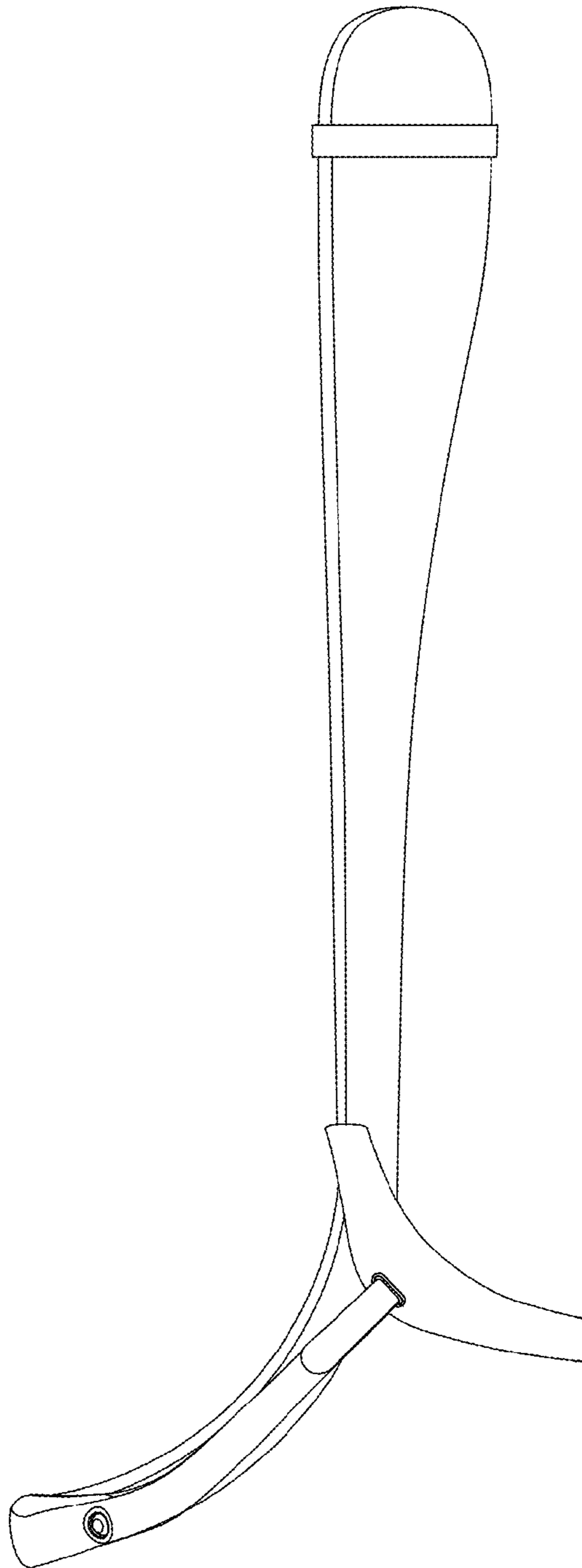

FIG. 29

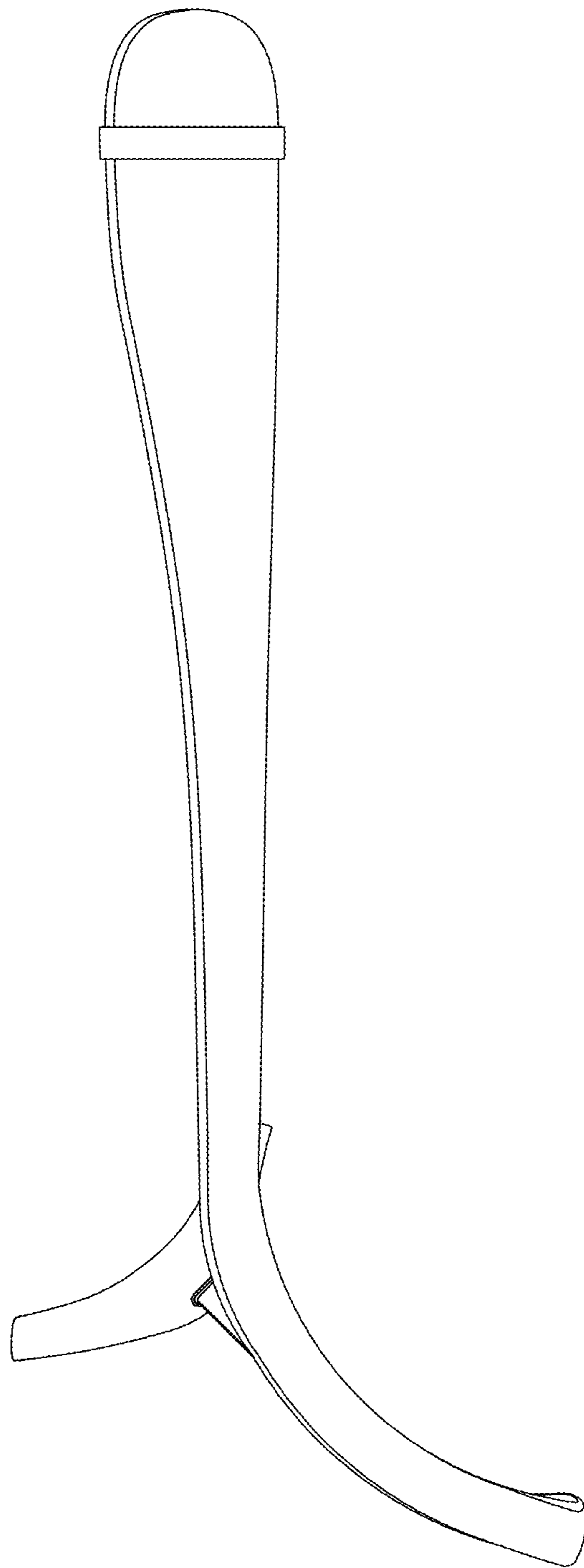

FIG. 30



FIG. 31