



US00D704306S

(12) **United States Design Patent**
Watson et al.

(10) **Patent No.:** **US D704,306 S**

(45) **Date of Patent:** **** May 6, 2014**

(54) **INJECTION LANCE PLATE**

Primary Examiner — Cynthia Ramirez

(75) Inventors: **Vaughn Ryan Watson**, Frisco, TX (US);
Russell Todd Bryan, Arlington, TX (US)

(74) *Attorney, Agent, or Firm* — Fulbright & Jaworski LLP

(73) Assignee: **Peerless Mfg. Co.**, Dallas, TX (US)

(57) **CLAIM**

The ornamental design for an injection lance plate, as shown and described.

(**) Term: **14 Years**

(21) Appl. No.: **29/429,283**

(22) Filed: **Aug. 8, 2012**

DESCRIPTION

(51) **LOC (10) Cl.** **23-01**

(52) **U.S. Cl.**

USPC **D23/249**

(58) **Field of Classification Search**

USPC D23/233–237, 244–249; 251/286, 174,
251/181, 180, 175, 192; 137/624.11,
137/624.12, 624.13, 624.16, 624.21

See application file for complete search history.

FIG. 1 is a front perspective view of the injection lance plate showing our new design;
FIG. 2 is a front view thereof;
FIG. 3 is a rear view thereof;
FIG. 4 is a right edge view thereof;
FIG. 5 is a left edge view thereof;
FIG. 6 is a top view thereof;
FIG. 7 is a bottom view thereof;
FIG. 8 is a front perspective view of a second embodiment thereof;
FIG. 9 is a front view of the second embodiment thereof;
FIG. 10 is a rear view of the second embodiment thereof;
FIG. 11 is a right edge view of the second embodiment thereof;
FIG. 12 is a left edge view of the second embodiment thereof;
FIG. 13 is a top view of the second embodiment thereof; and,
FIG. 14 is a bottom view of the second embodiment thereof.

(56) **References Cited**

U.S. PATENT DOCUMENTS

D198,886 S *	8/1964	Gifford	D23/244
D236,723 S *	9/1975	Scheffler	D23/246
D309,175 S *	7/1990	Hastings et al.	D23/245
D353,188 S *	12/1994	Jackson et al.	D23/245
D620,556 S *	7/2010	Hillhouse et al.	D23/235
D694,857 S *	12/2013	Au	D23/233

* cited by examiner

1 Claim, 8 Drawing Sheets

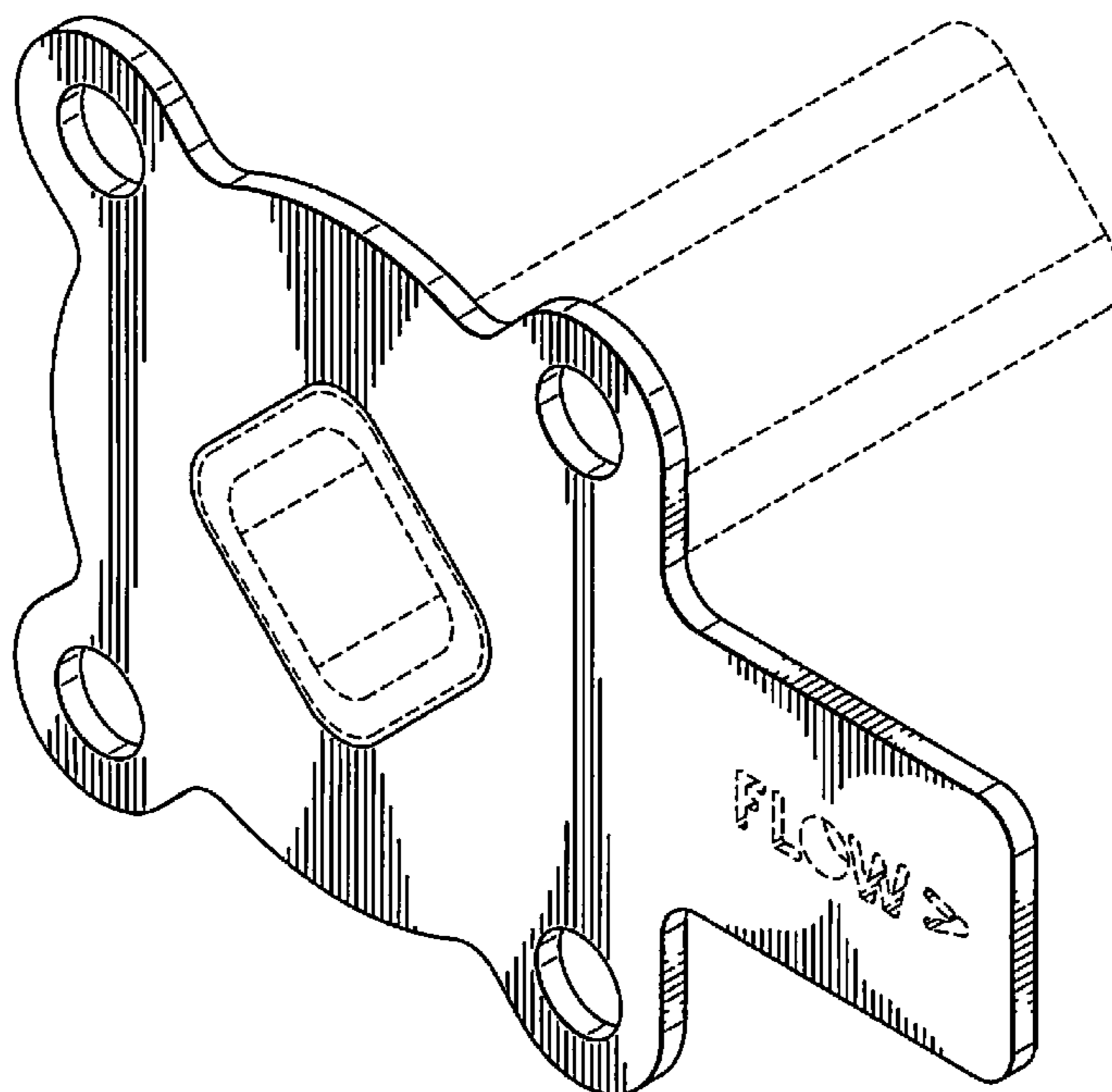

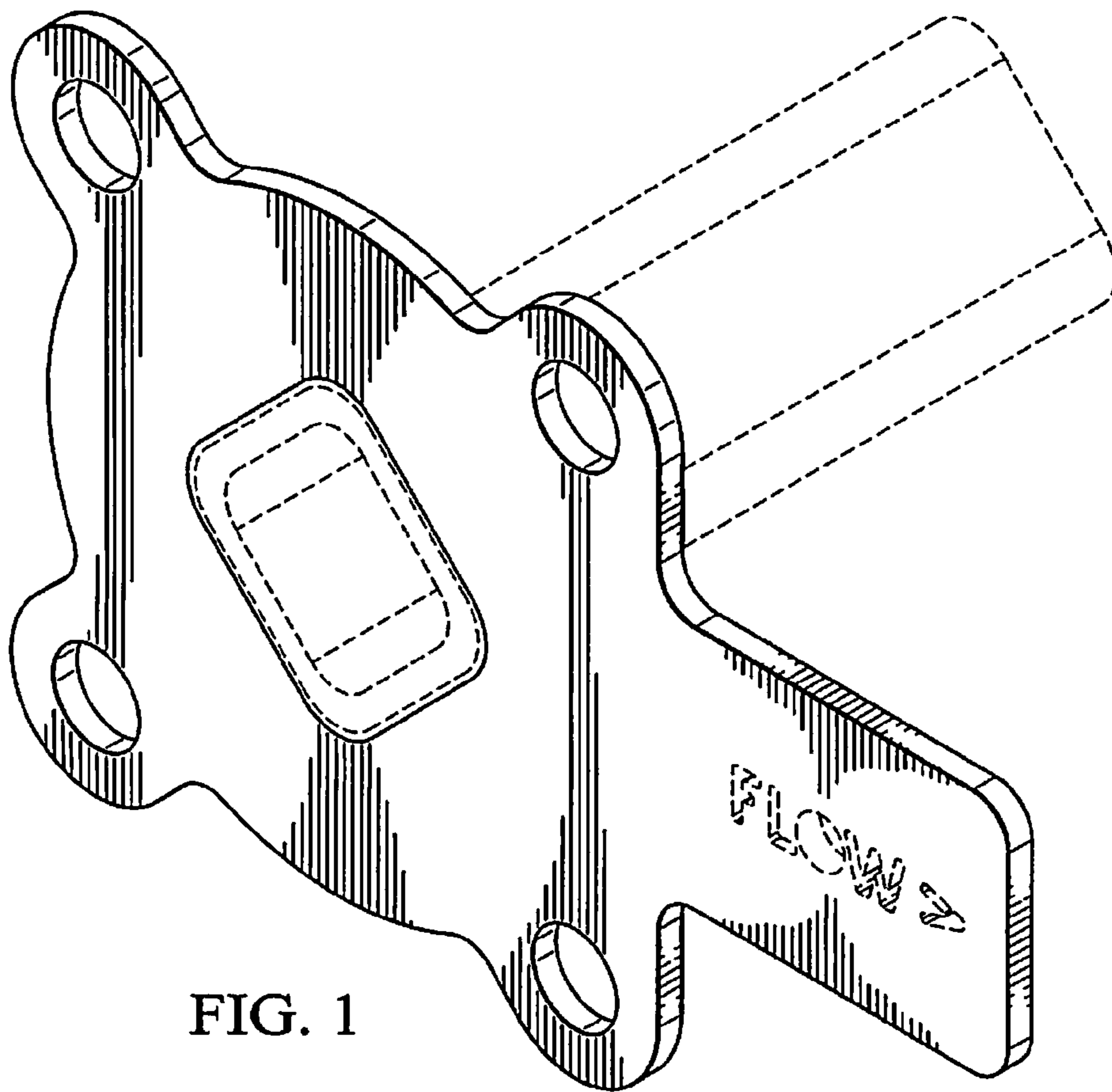

FIG. 1

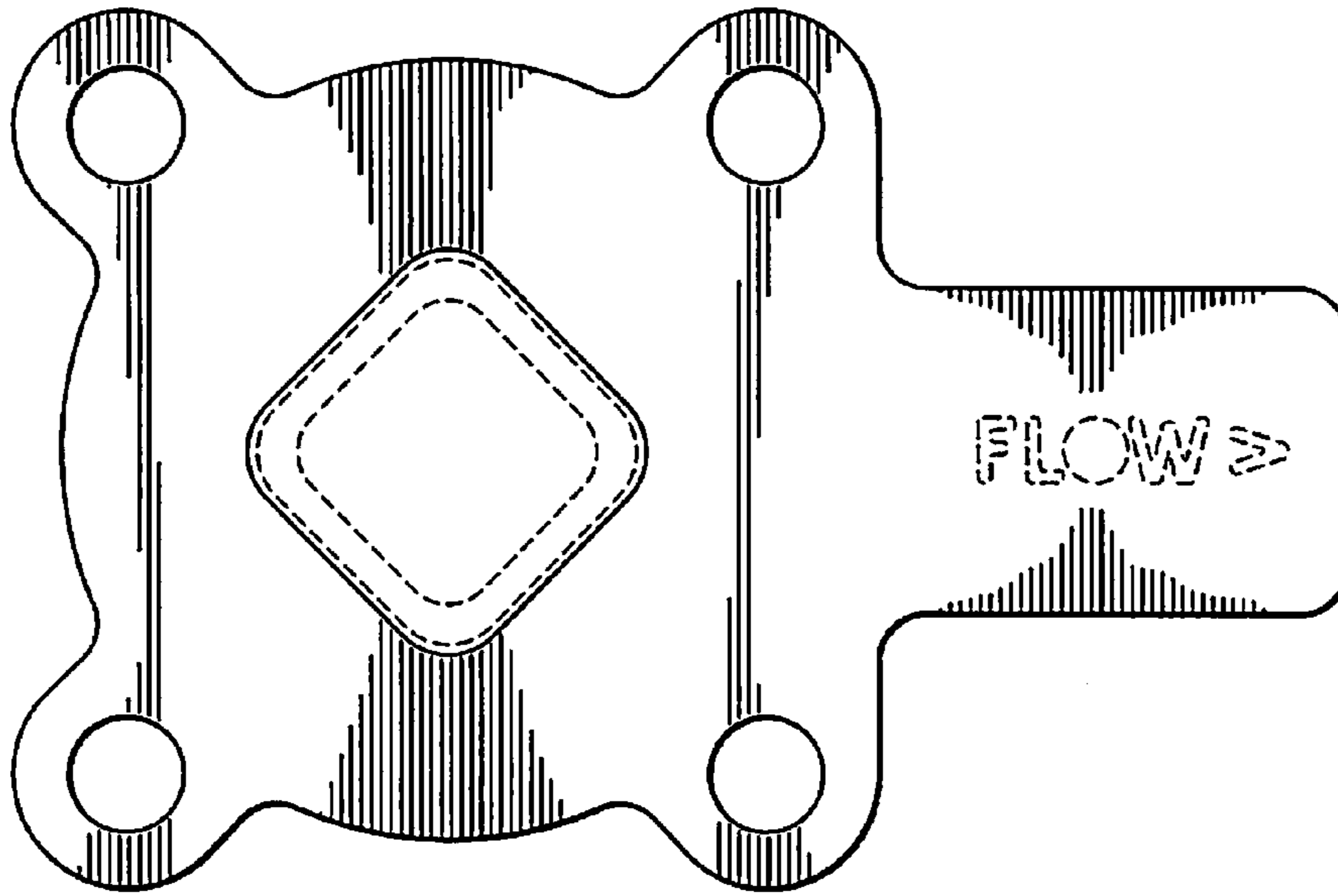

FIG. 2

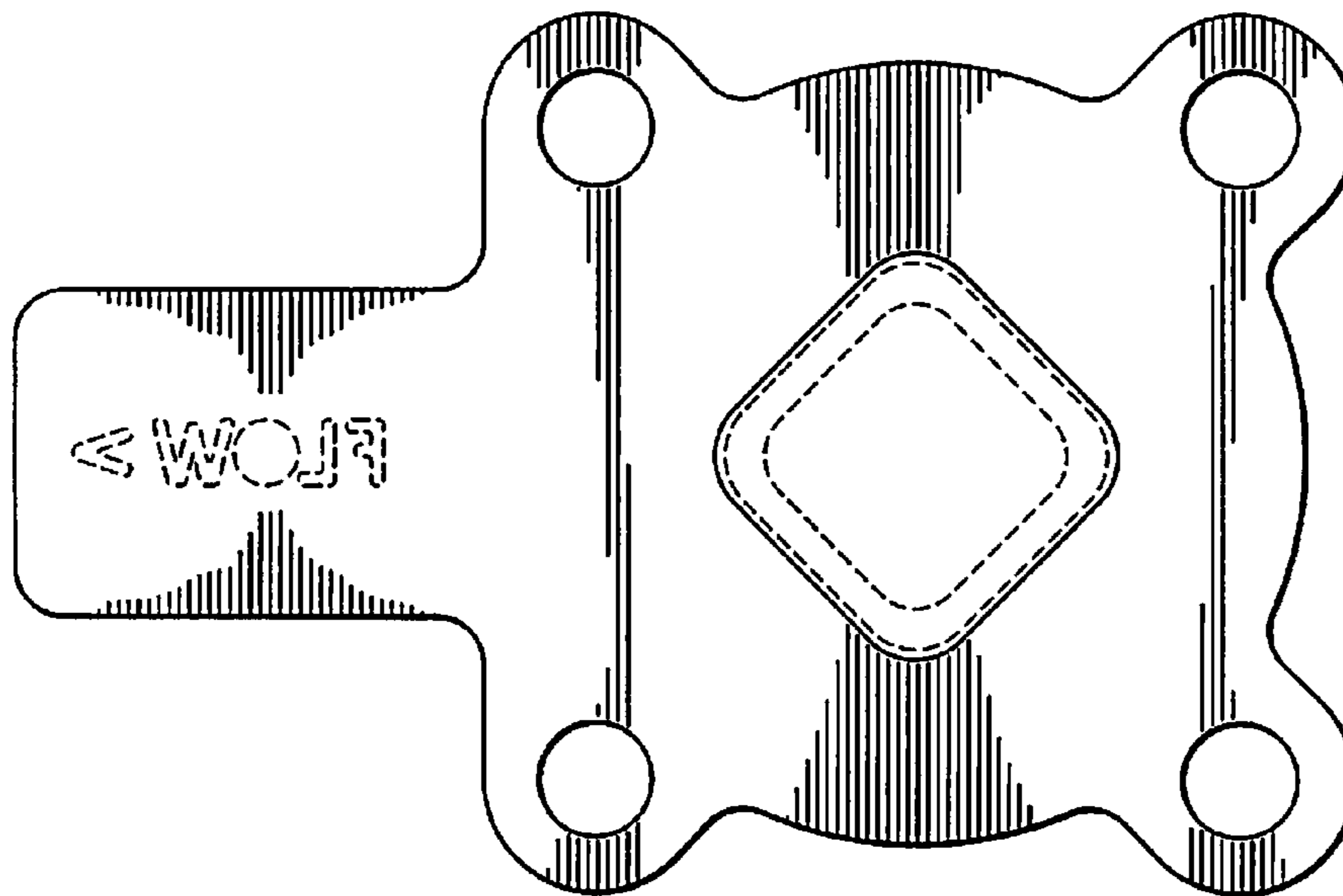

FIG. 3

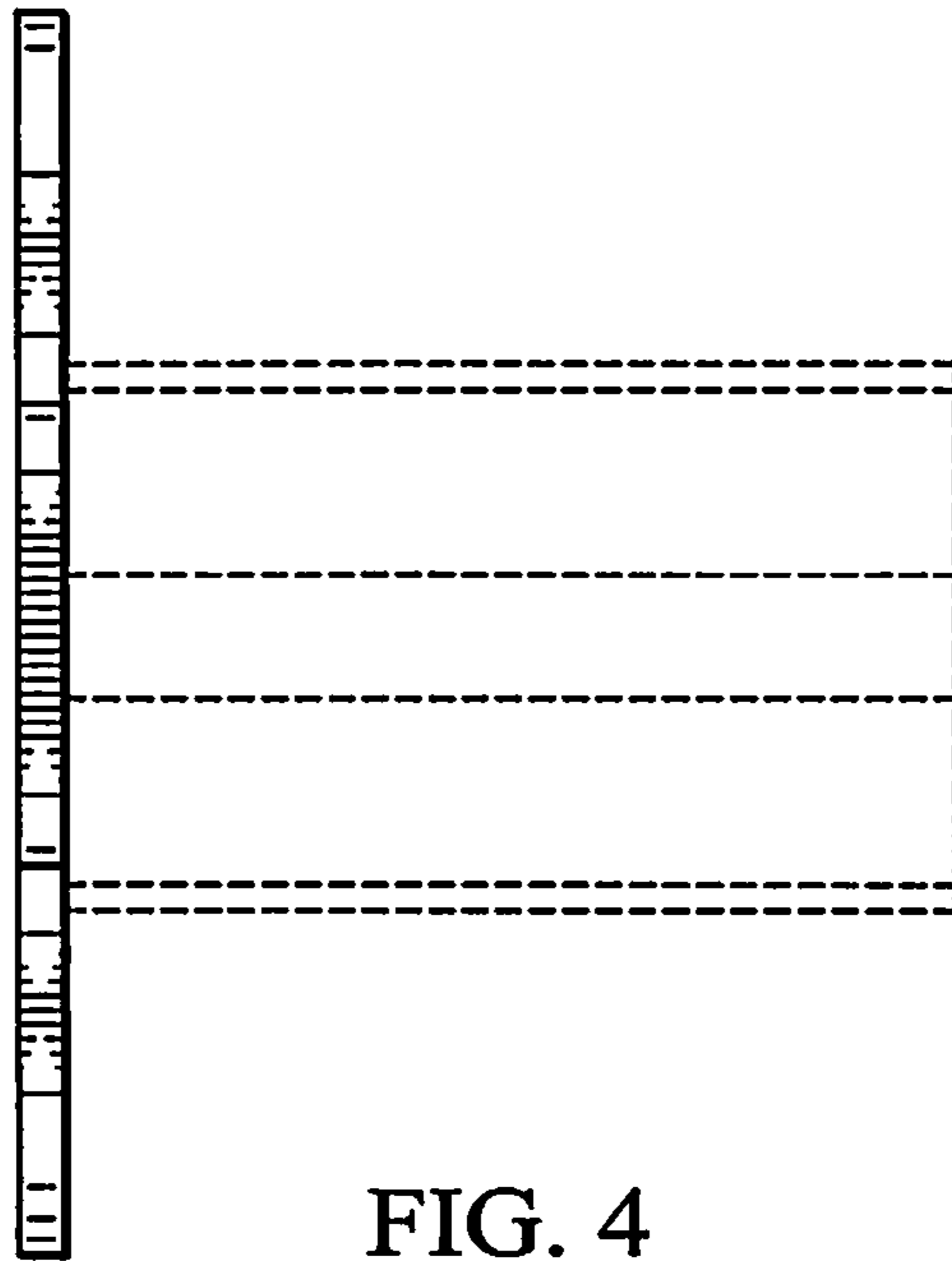

FIG. 4

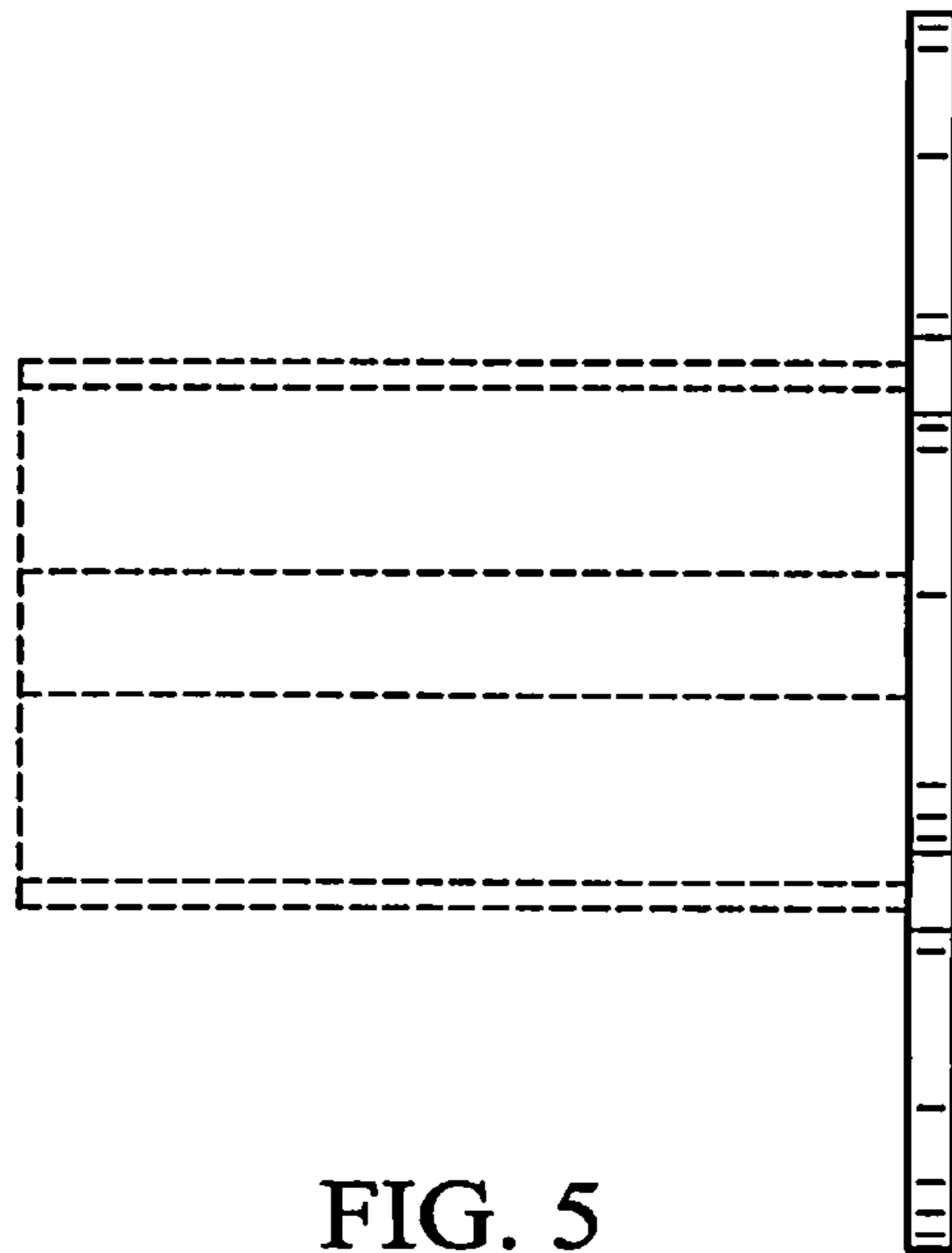

FIG. 5

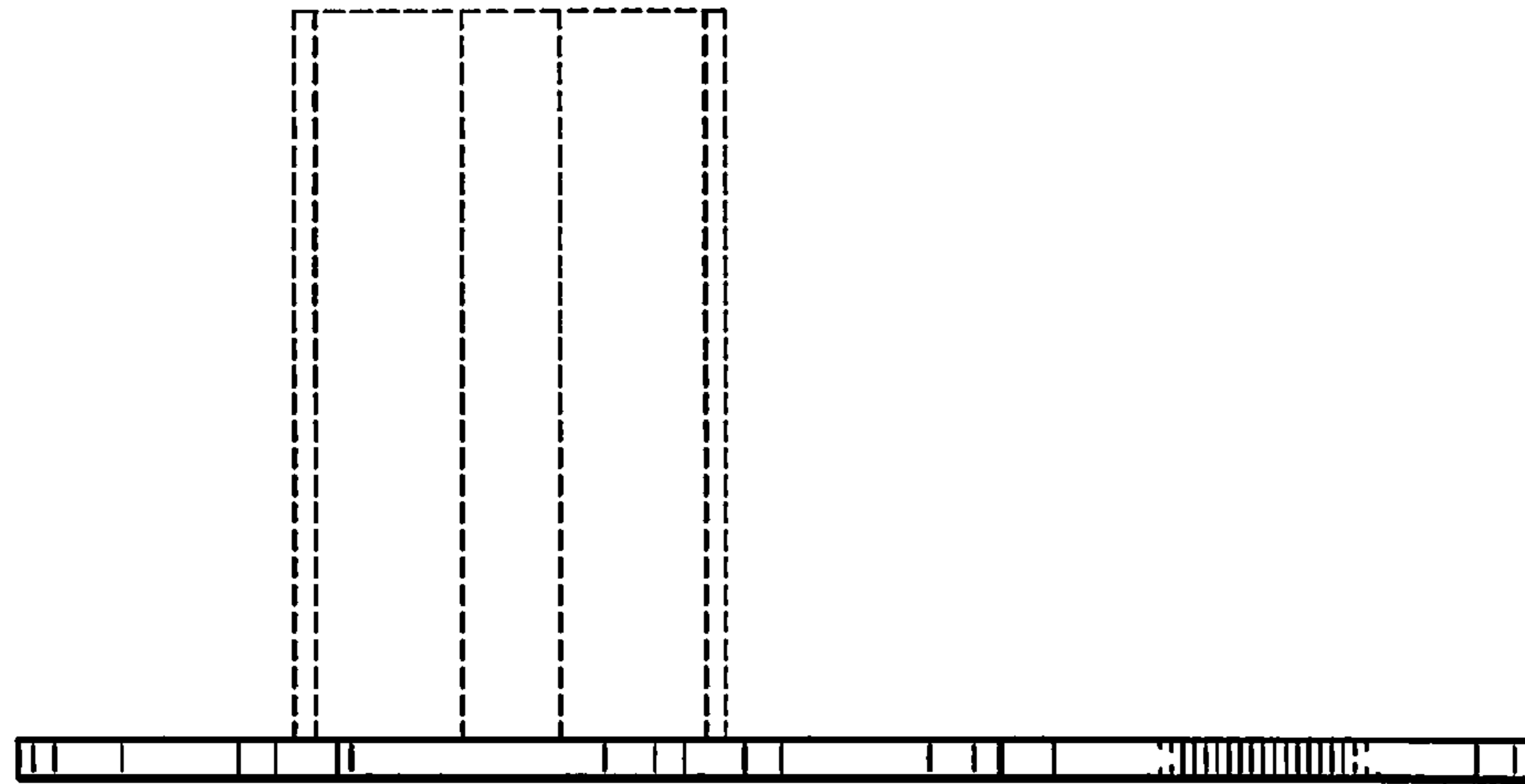

FIG. 6

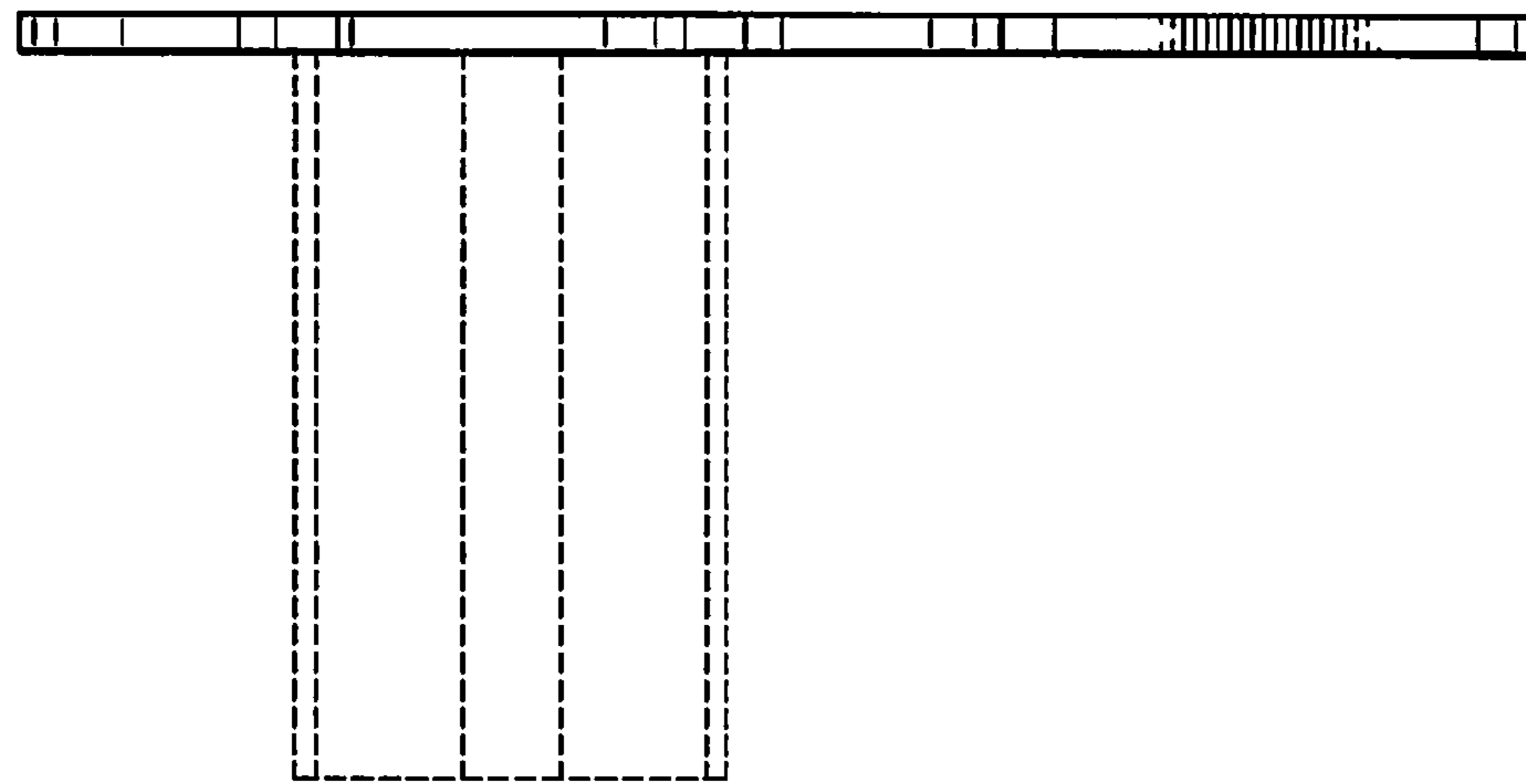

FIG. 7

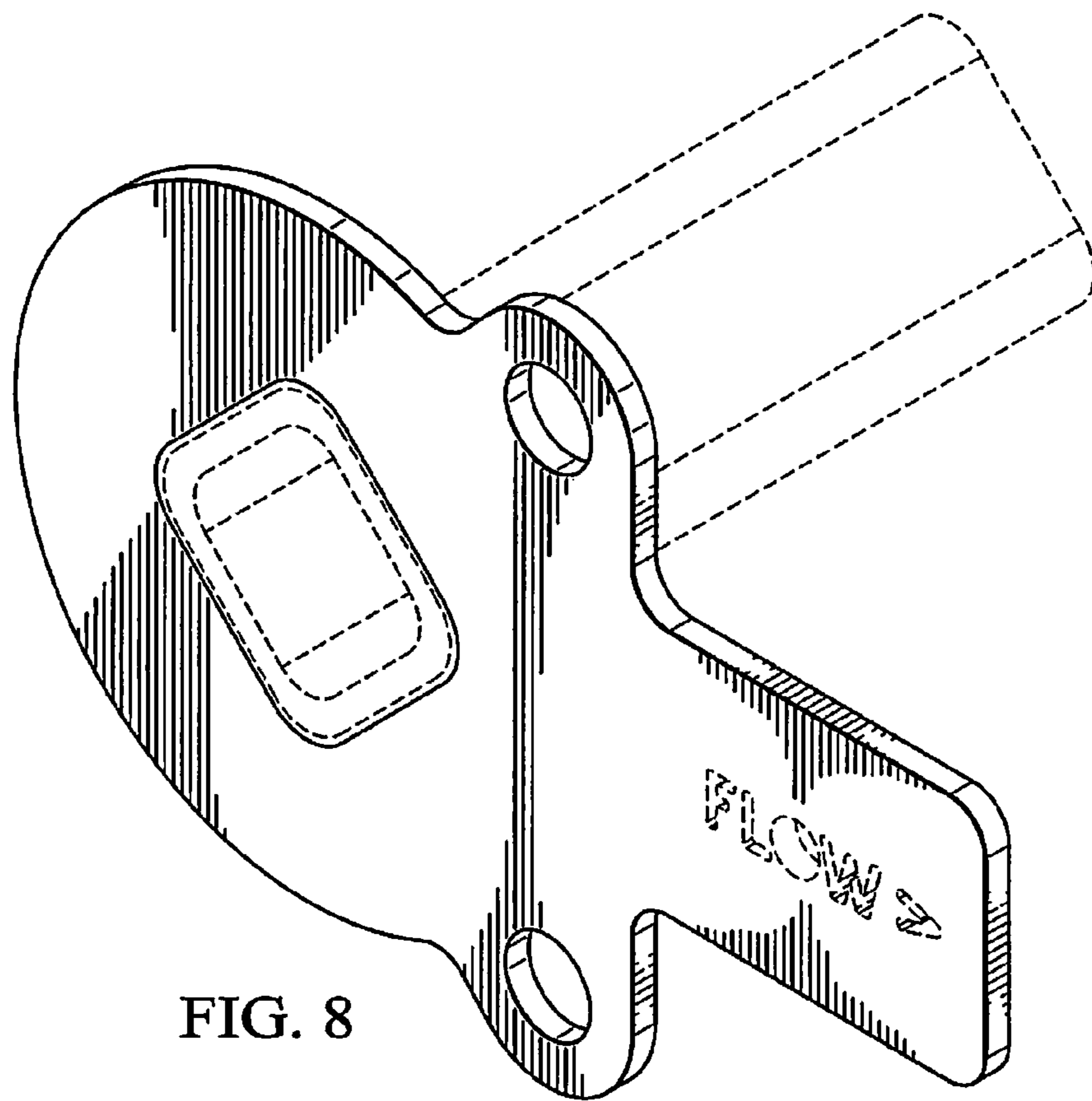

FIG. 8

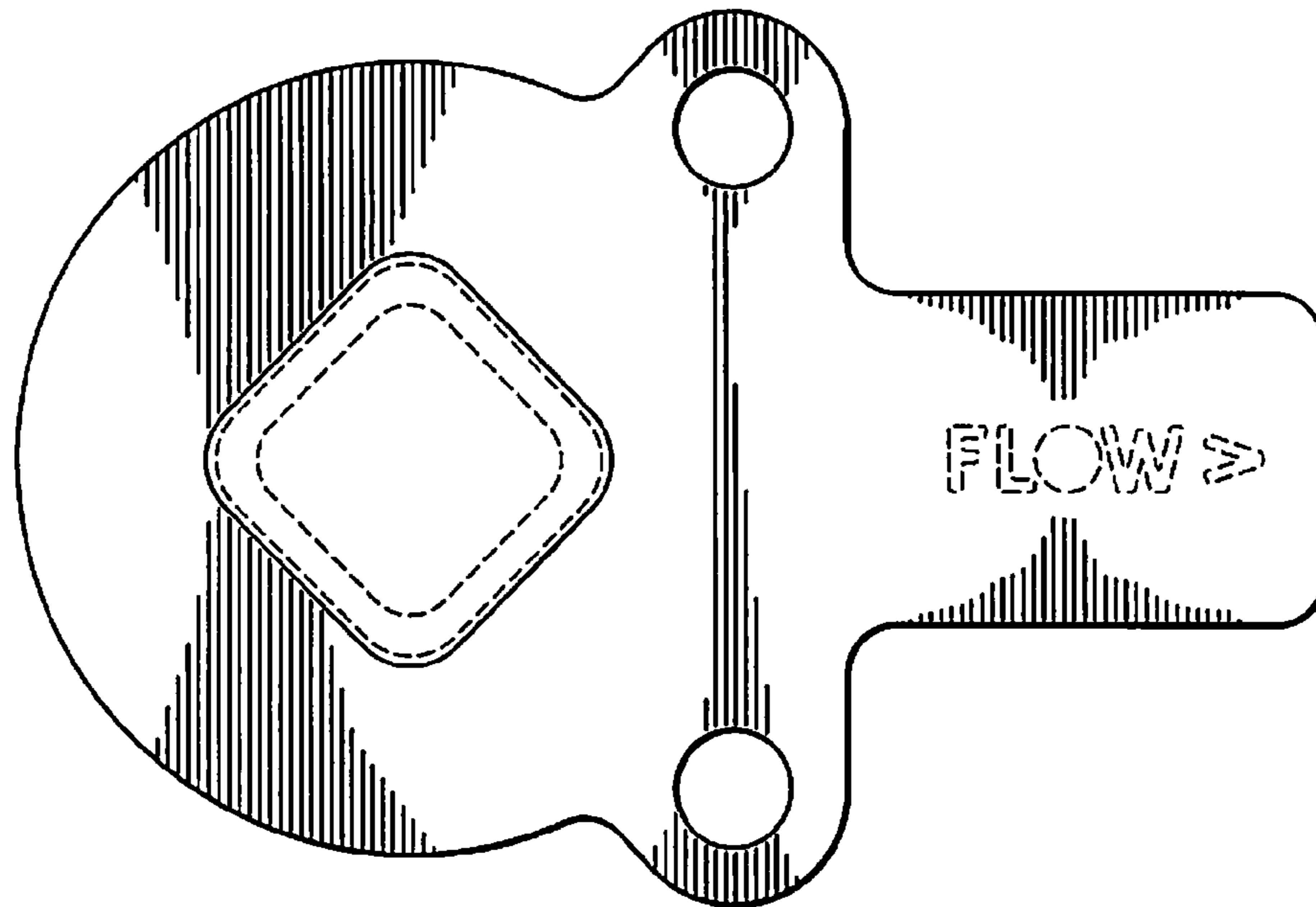

FIG. 9

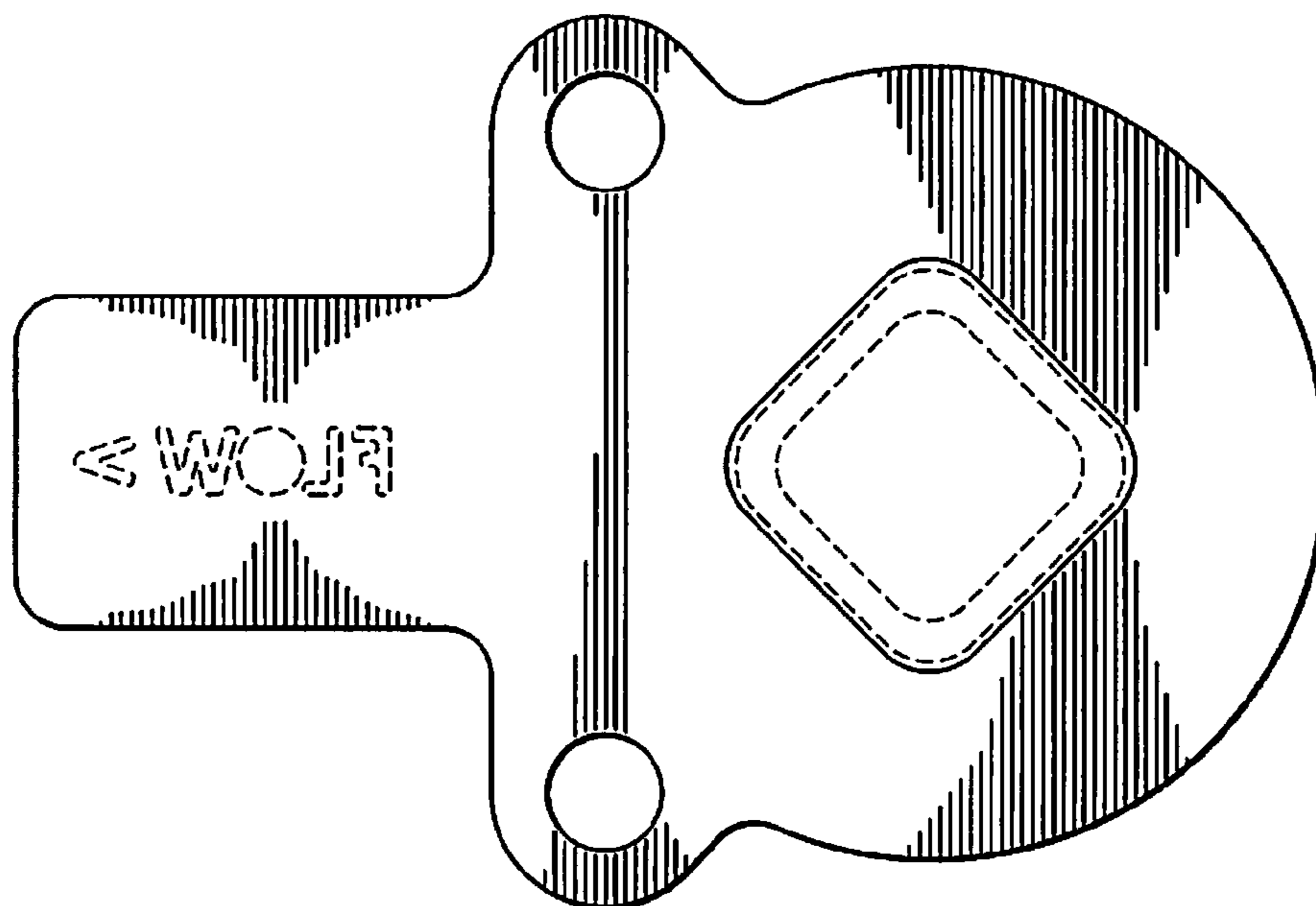

FIG. 10

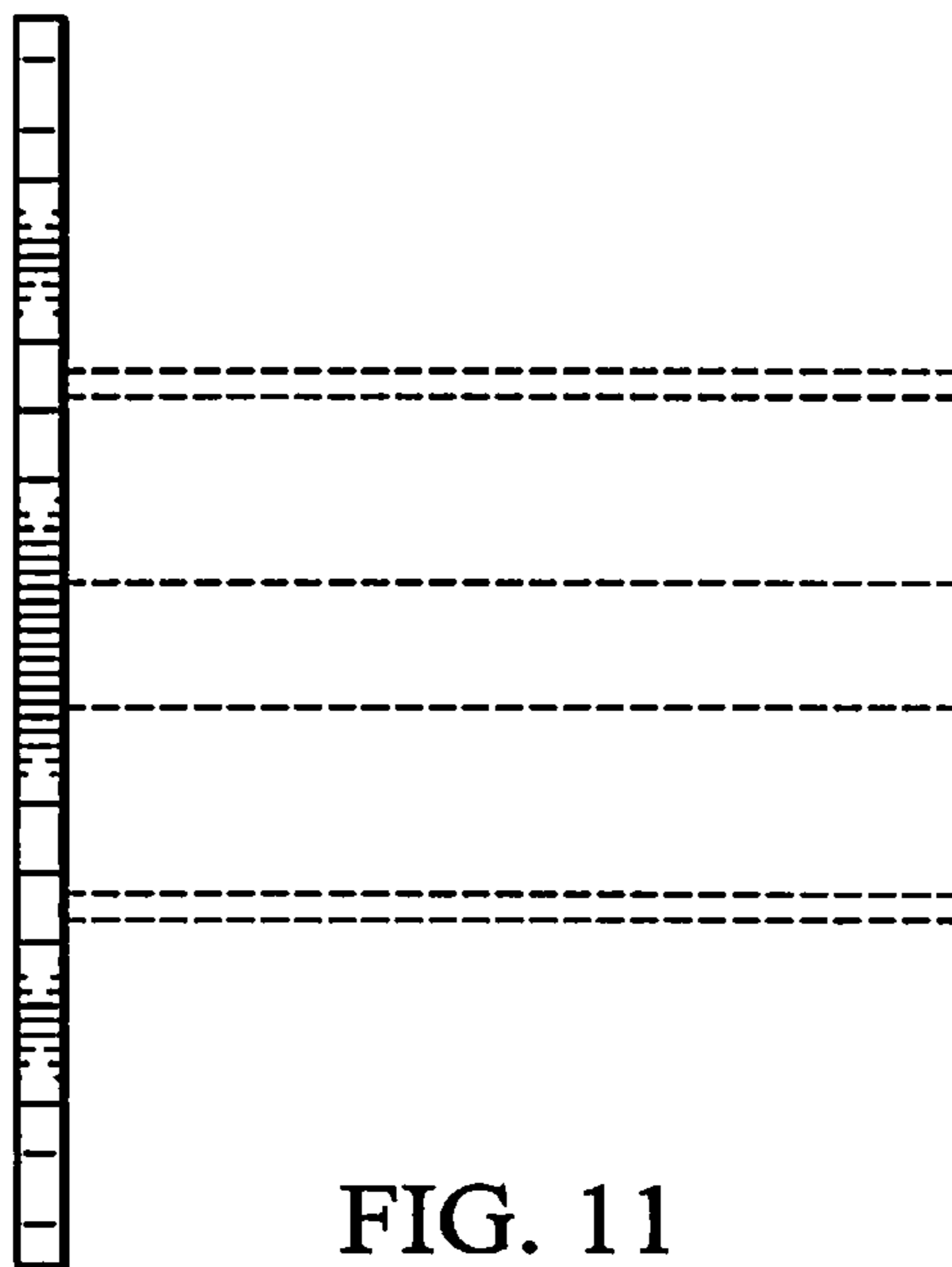

FIG. 11

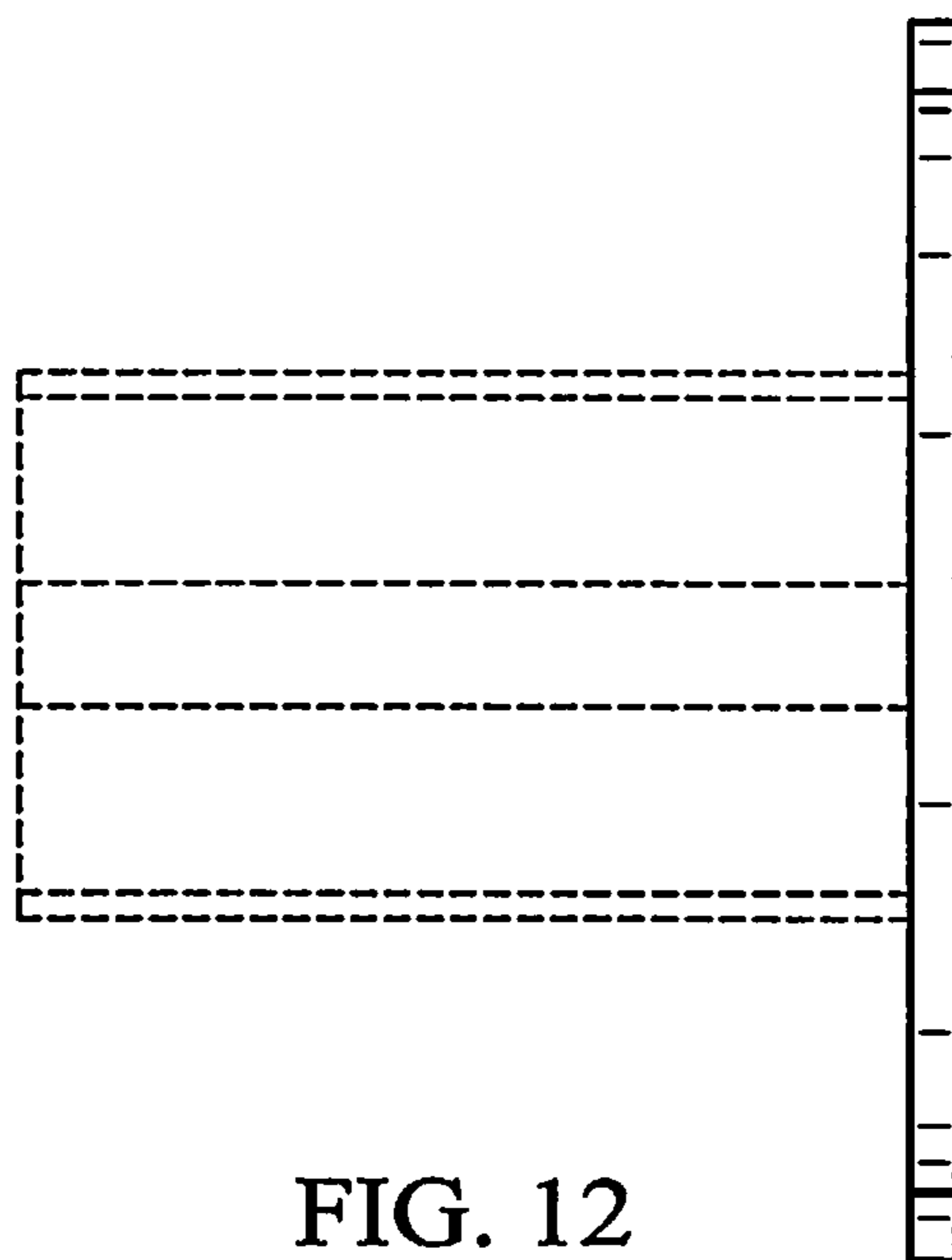

FIG. 12

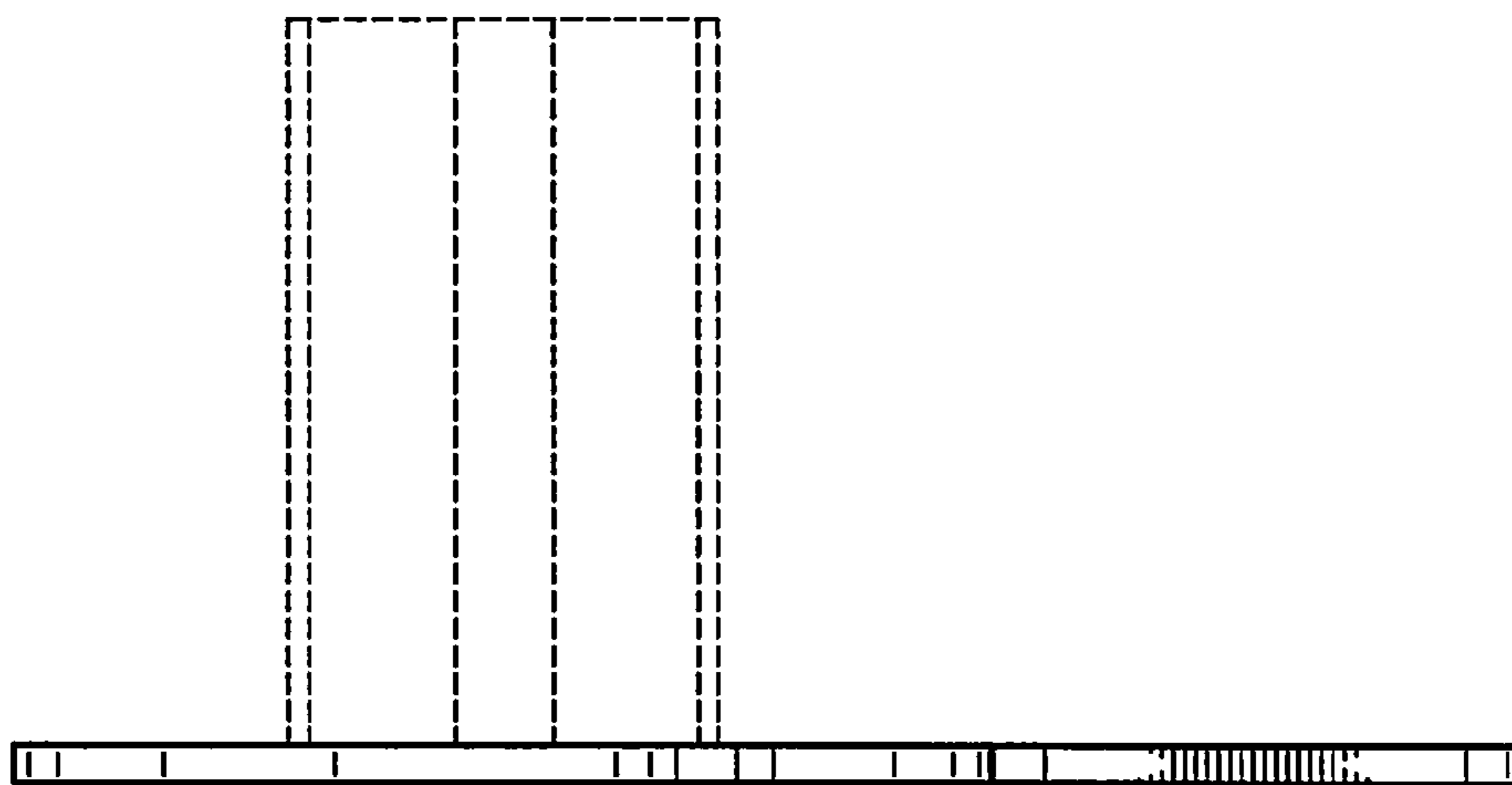

FIG. 13

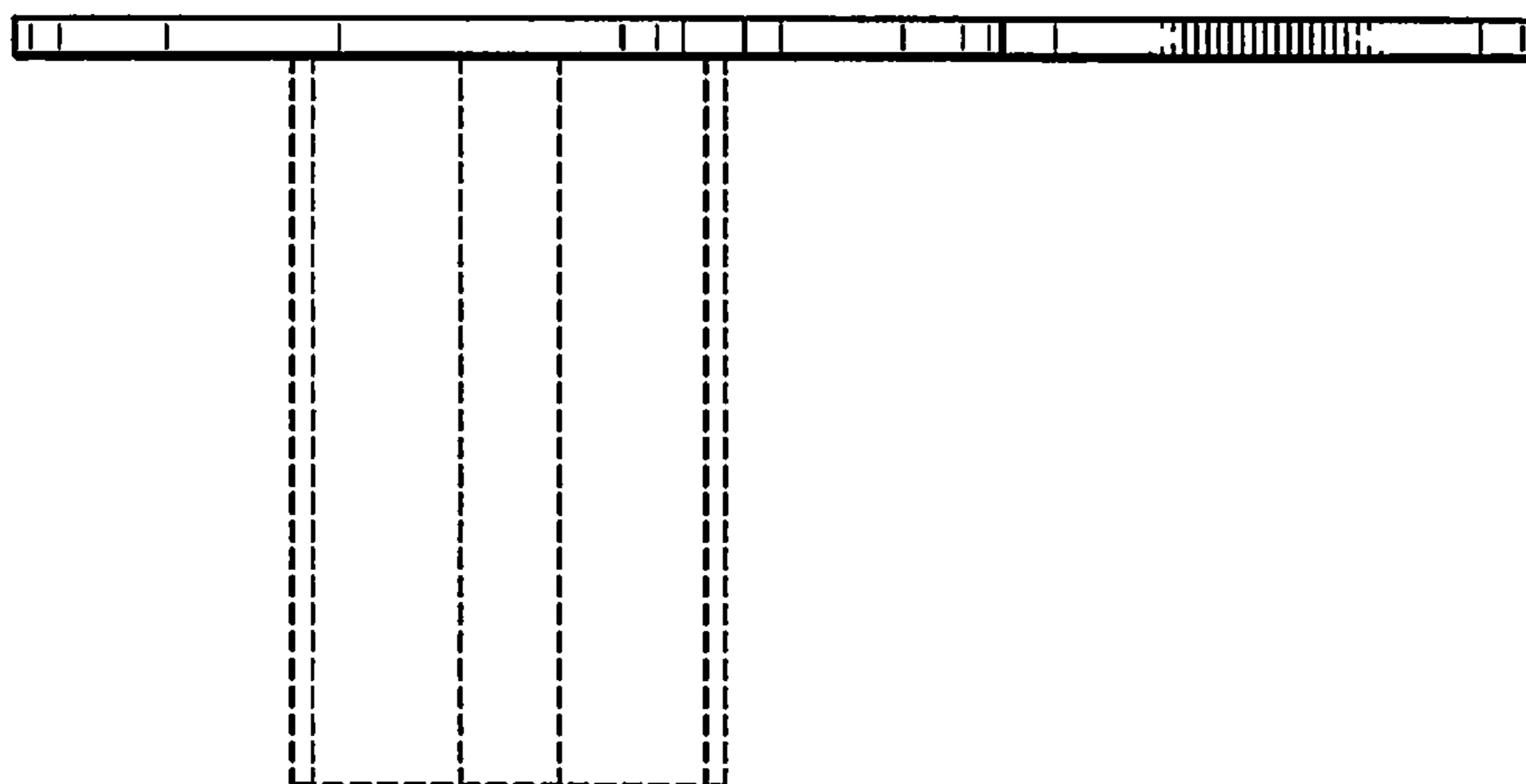

FIG. 14