



US00D704287S

(12) **United States Design Patent**  
**Tang et al.**

(10) **Patent No.:** **US D704,287 S**

(45) **Date of Patent:** **\*\* May 6, 2014**

(54) **PUTTER HEAD**

(71) Applicant: **Callaway Golf Company**, Carlsbad, CA (US)

(72) Inventors: **Larry G. Tang**, Carlsbad, CA (US);  
**Augustin W. Rollinson**, Carlsbad, CA (US); **Christopher Koske**, Vista, CA (US)

(73) Assignee: **Callaway Golf Company**, Carlsbad, CA (US)

(\*\*) Term: **14 Years**

(21) Appl. No.: **29/454,404**

(22) Filed: **May 9, 2013**

(51) **LOC (10) Cl.** ..... **21-02**

(52) **U.S. Cl.**  
USPC ..... **D21/742**

(58) **Field of Classification Search**  
USPC ..... D21/736-746, 759; 473/324-331,  
473/340-341, 251-256

See application file for complete search history.

(56) **References Cited**

**U.S. PATENT DOCUMENTS**

D458,656 S *	6/2002	Tang et al.	.....	D21/738
D485,323 S *	1/2004	Wagner et al.	.....	D21/744
D572,780 S *	7/2008	Rollinson	.....	D21/744
D592,717 S *	5/2009	Rollinson	.....	D21/742

D619,665 S *	7/2010	Rollinson et al.	.....	D21/742
D641,816 S *	7/2011	Rollinson et al.	.....	D21/744
D650,459 S *	12/2011	Rollinson	.....	D21/746
D688,340 S *	8/2013	Tang et al.	.....	D21/742

\* cited by examiner

*Primary Examiner* — Mitchell Siegel

(74) *Attorney, Agent, or Firm* — Rebecca Hanovice;  
Michael A. Catania; Sonia Lari

(57) **CLAIM**

The ornamental design for a putter head, as shown and described.

**DESCRIPTION**

FIG. 1 is a perspective view of a putter head as claimed herein;  
 FIG. 2 is a right side view thereof;  
 FIG. 3 is a left side view thereof;  
 FIG. 4 is a front elevational view thereof;  
 FIG. 5 is a rear elevational view thereof;  
 FIG. 6 is a top plan view thereof;  
 FIG. 7 is a bottom plan view thereof;  
 FIG. 8 is a perspective view of a second embodiment of a putter head of FIG. 1;  
 FIG. 9 is a right side view of FIG. 8;  
 FIG. 10 is a left side view of FIG. 8;  
 FIG. 11 is a front elevational view of FIG. 8;  
 FIG. 12 is a rear elevational view of FIG. 8;  
 FIG. 13 is a top plan view of FIG. 8; and,  
 FIG. 14 is a bottom plan view of FIG. 8.

The broken lines are included for the purpose of illustration only and form no part of the claimed design.

**1 Claim, 12 Drawing Sheets**

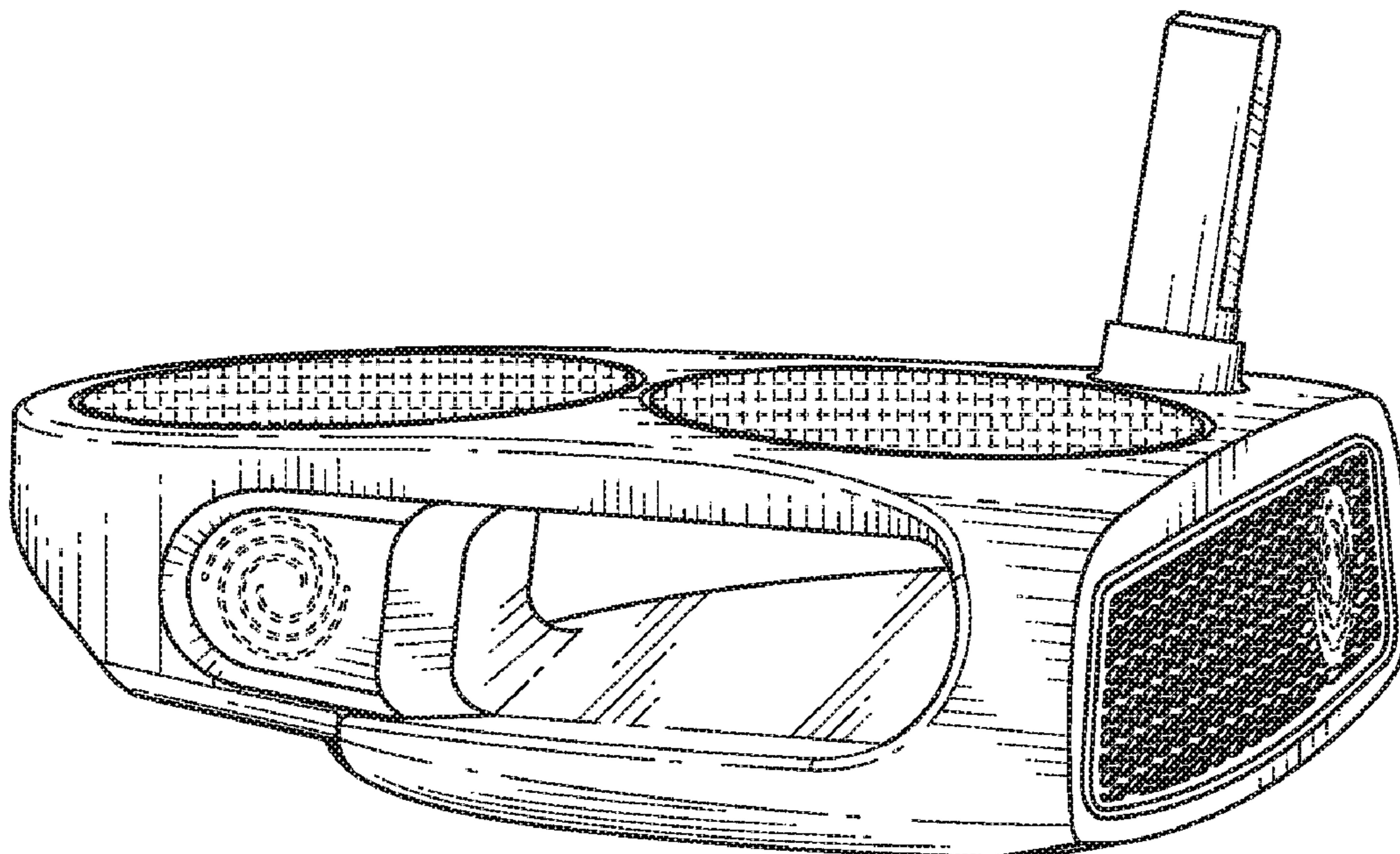

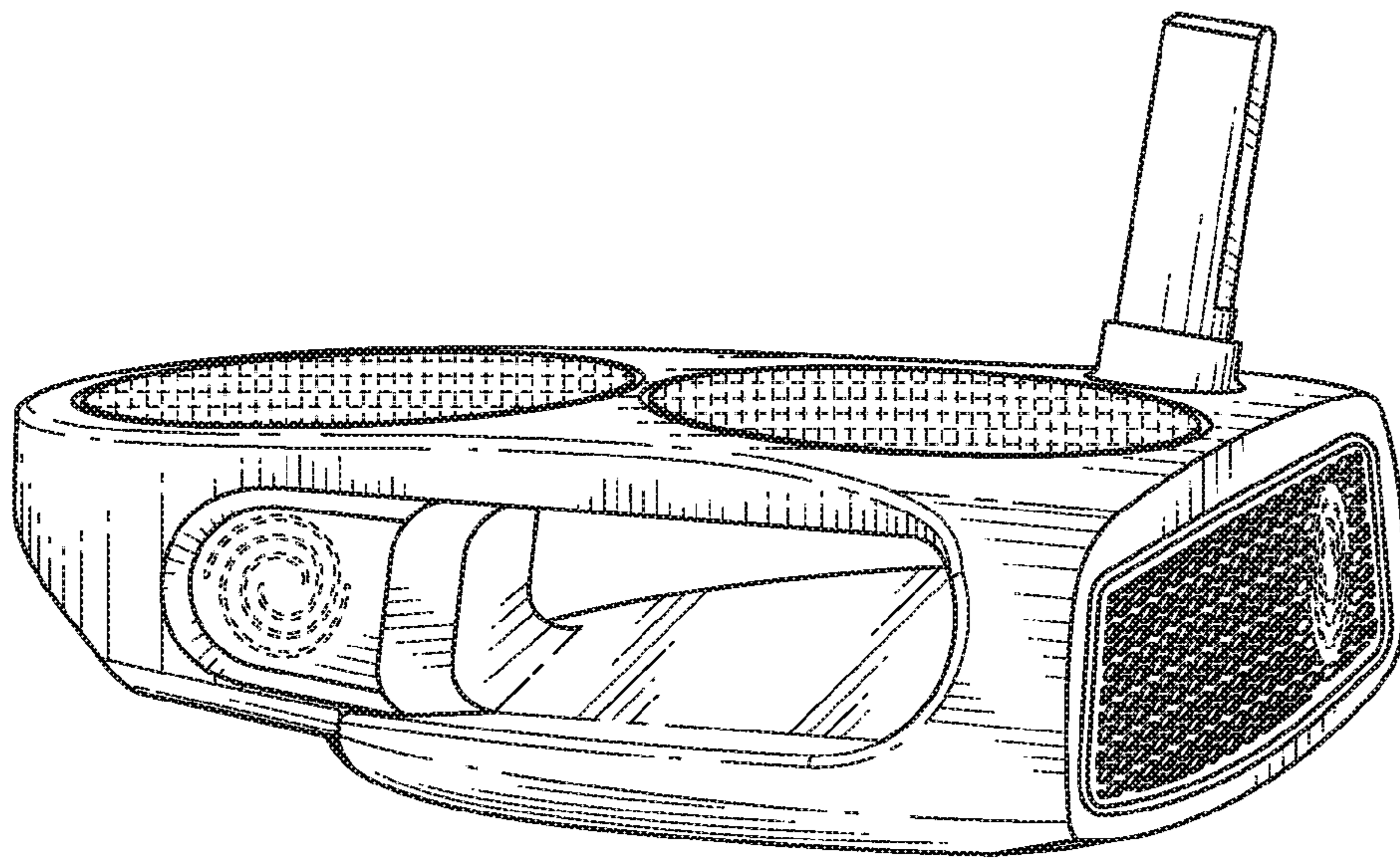

FIG. 1

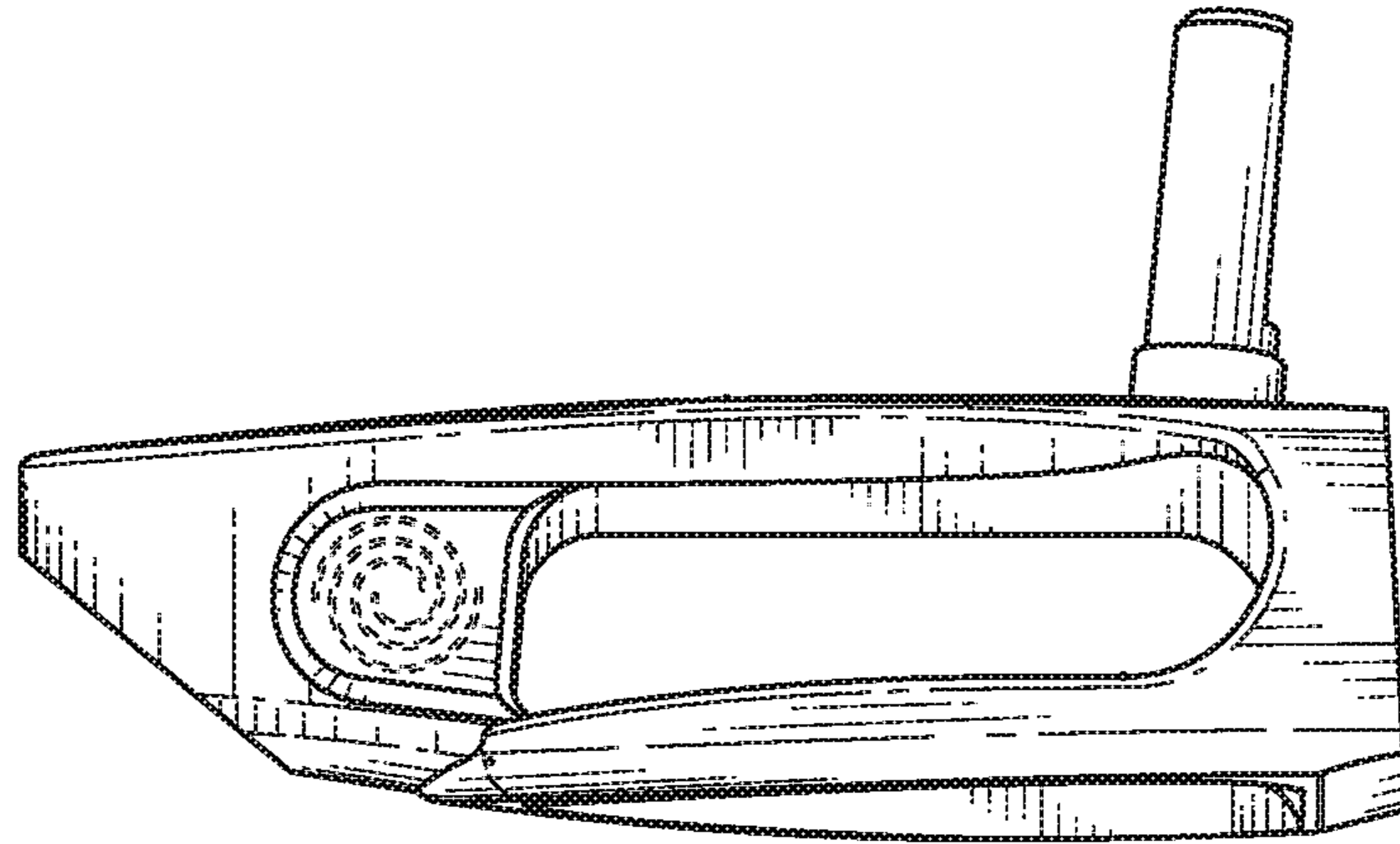

FIG. 2

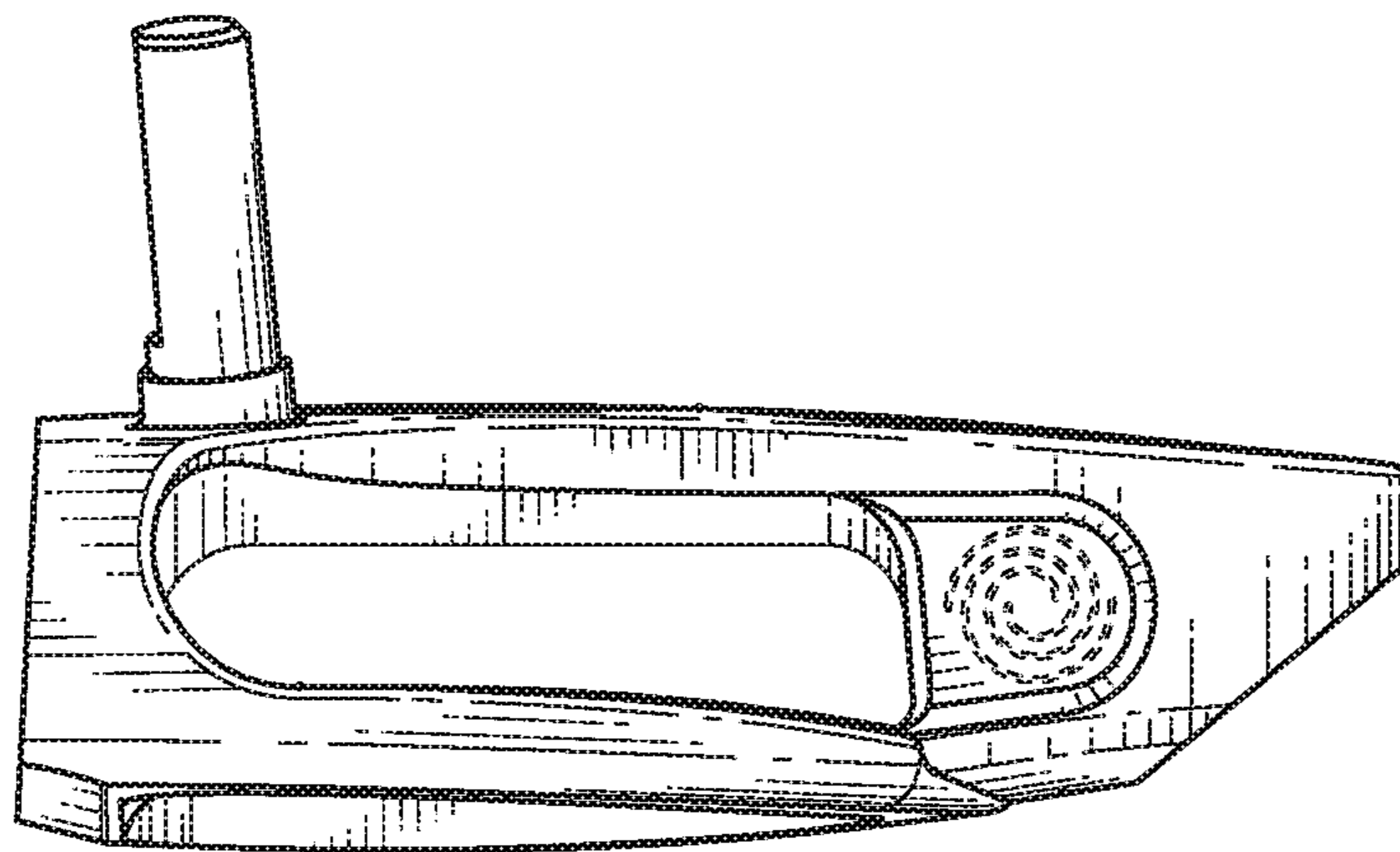

FIG. 3

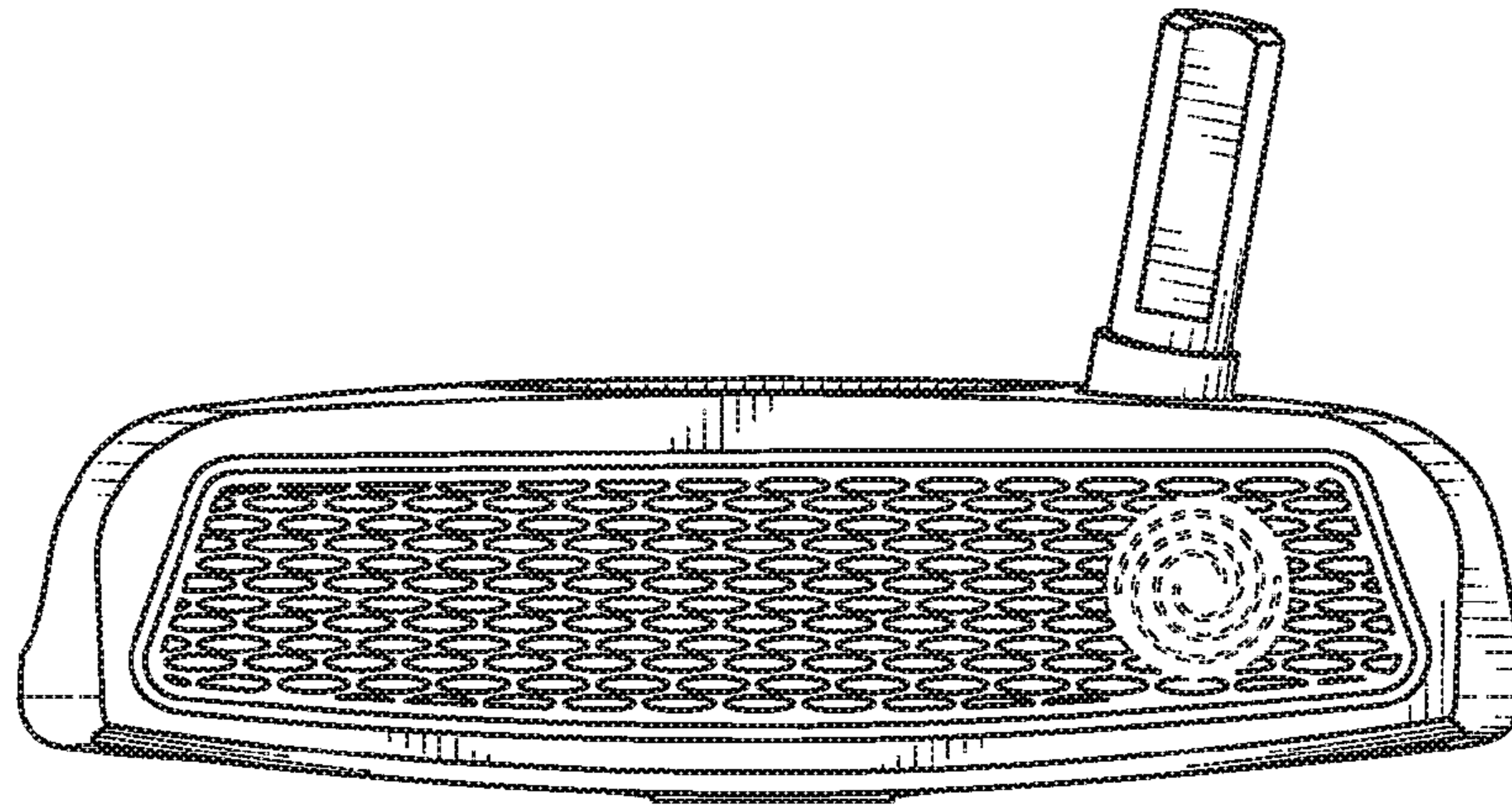

FIG. 4

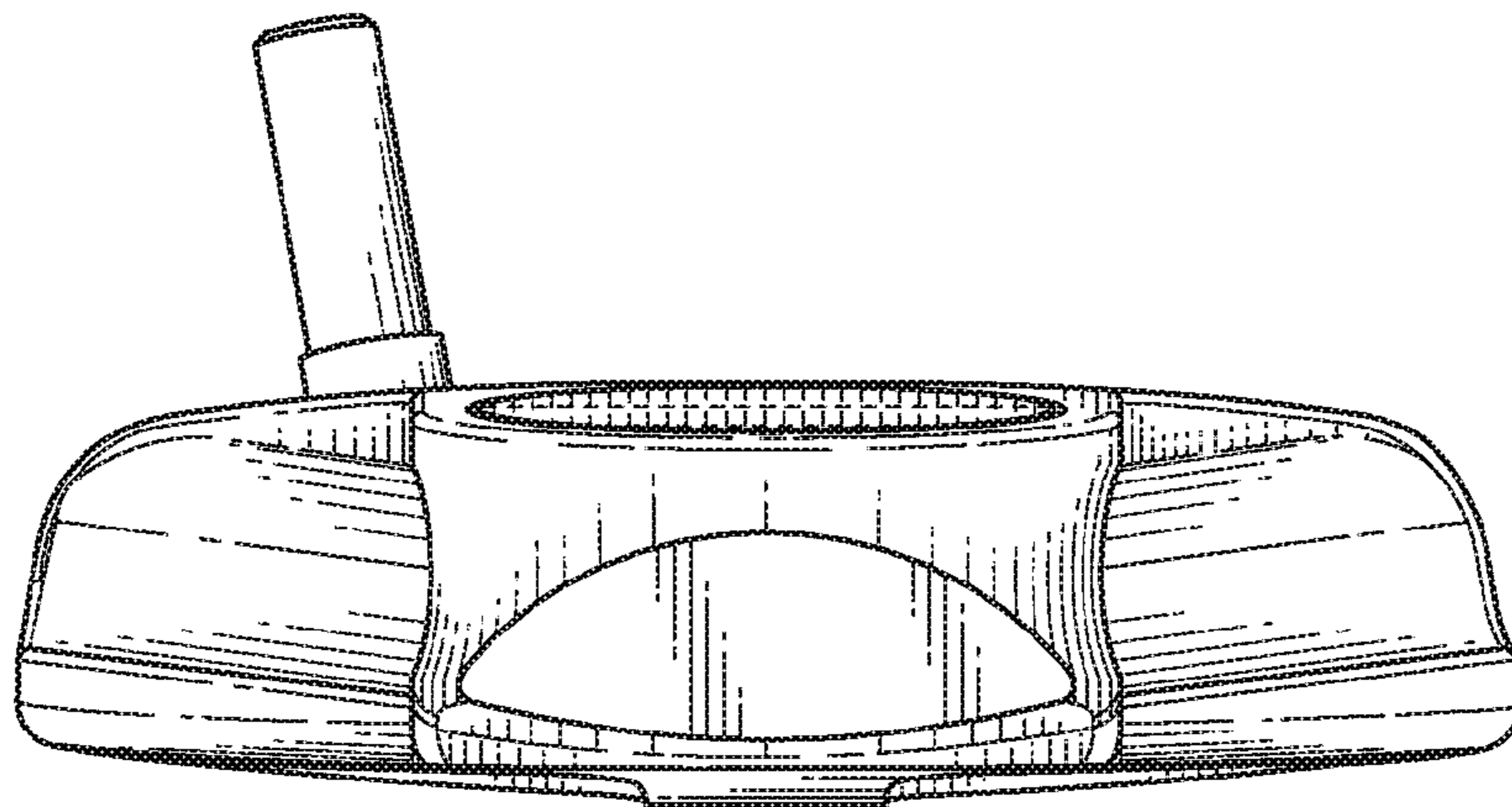

FIG. 5

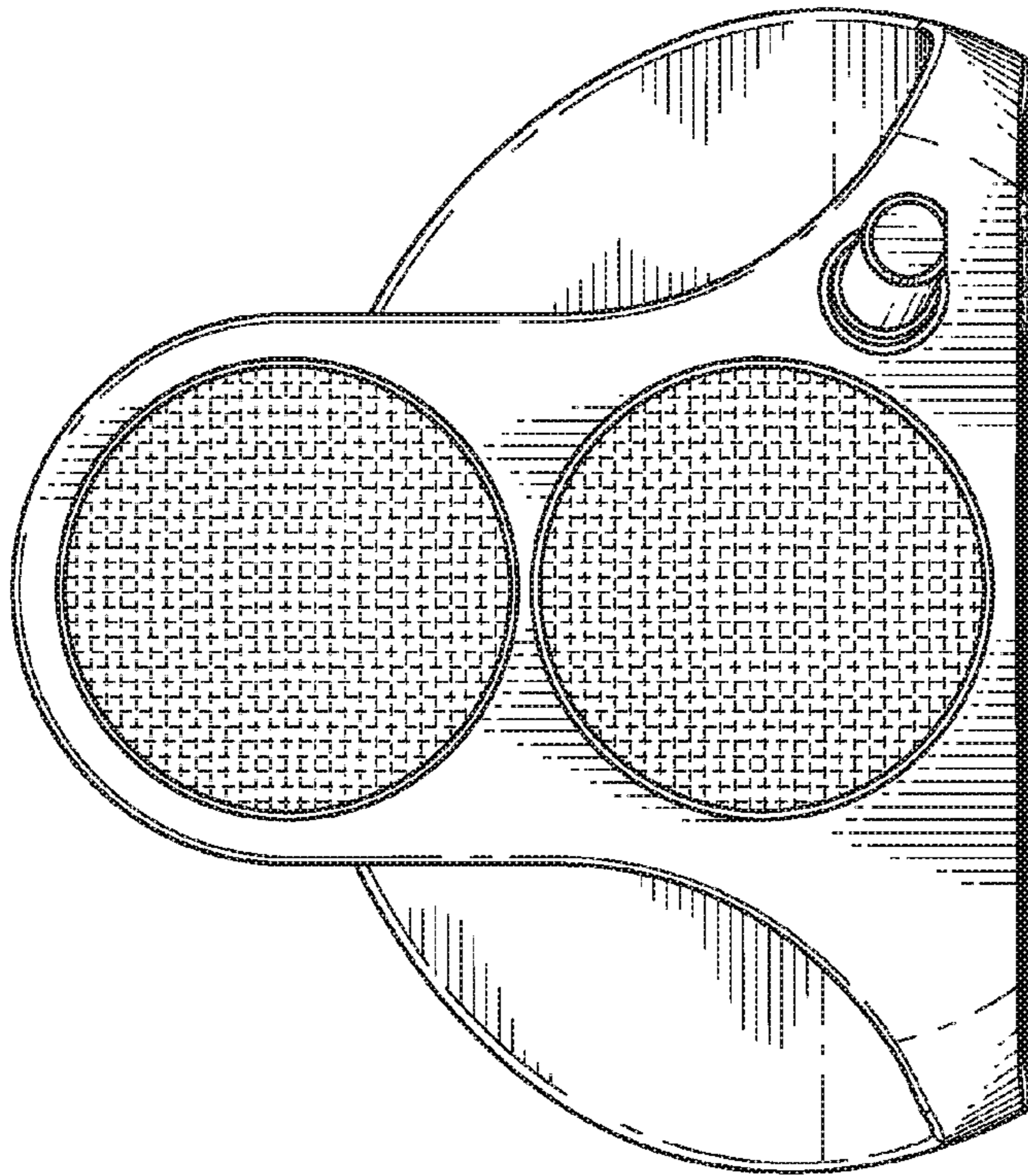

FIG. 6

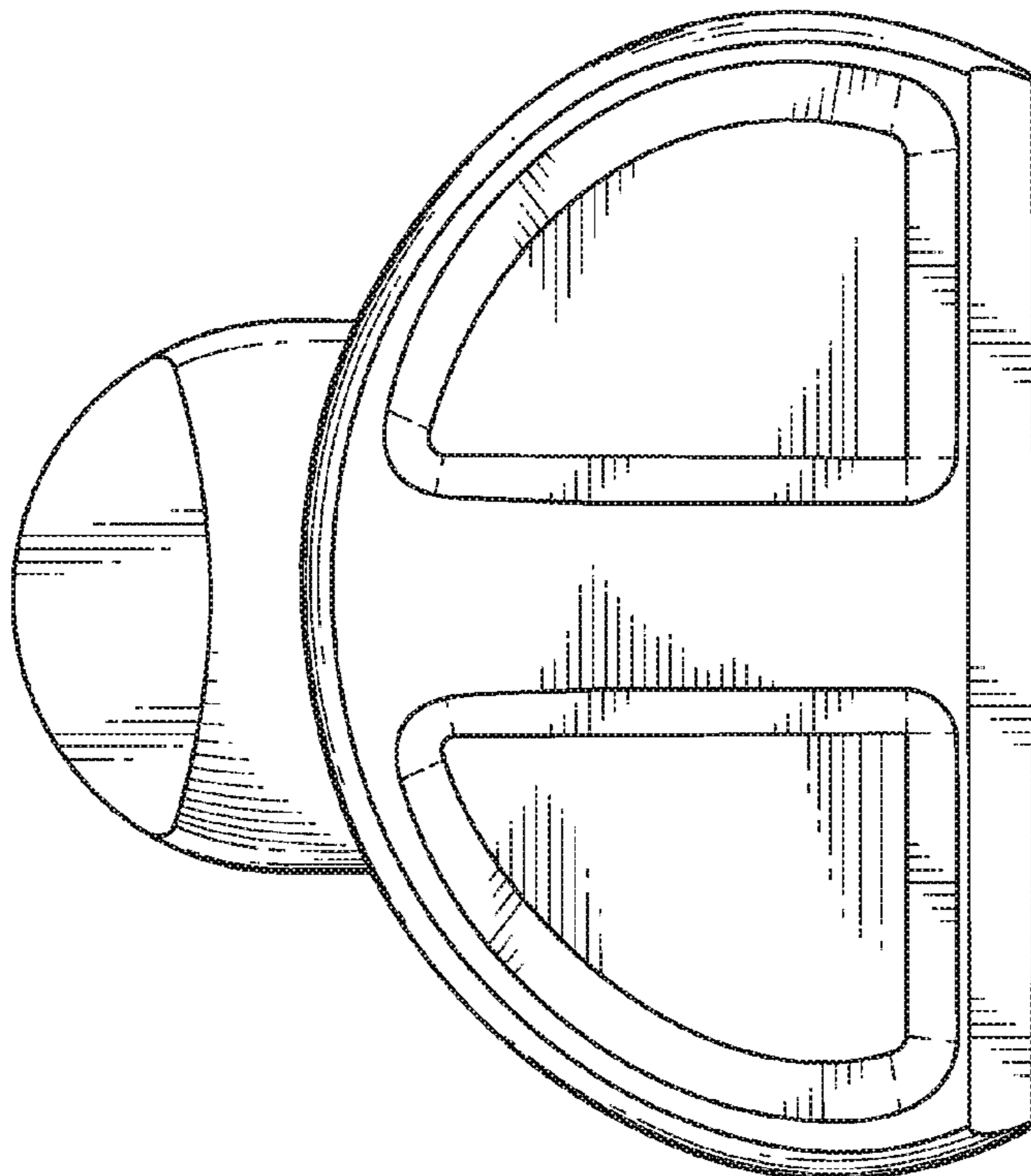

FIG. 7

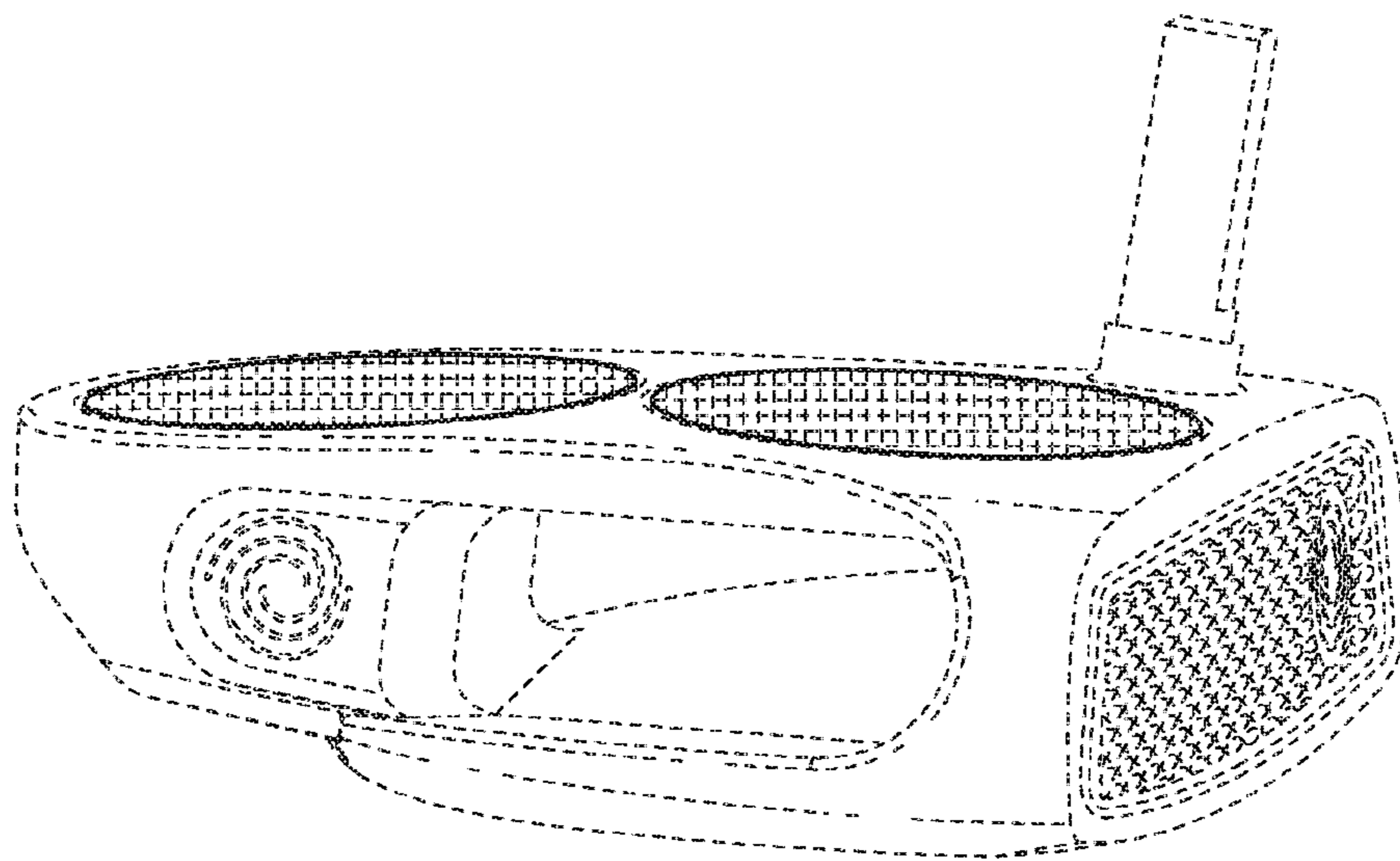

FIG. 8

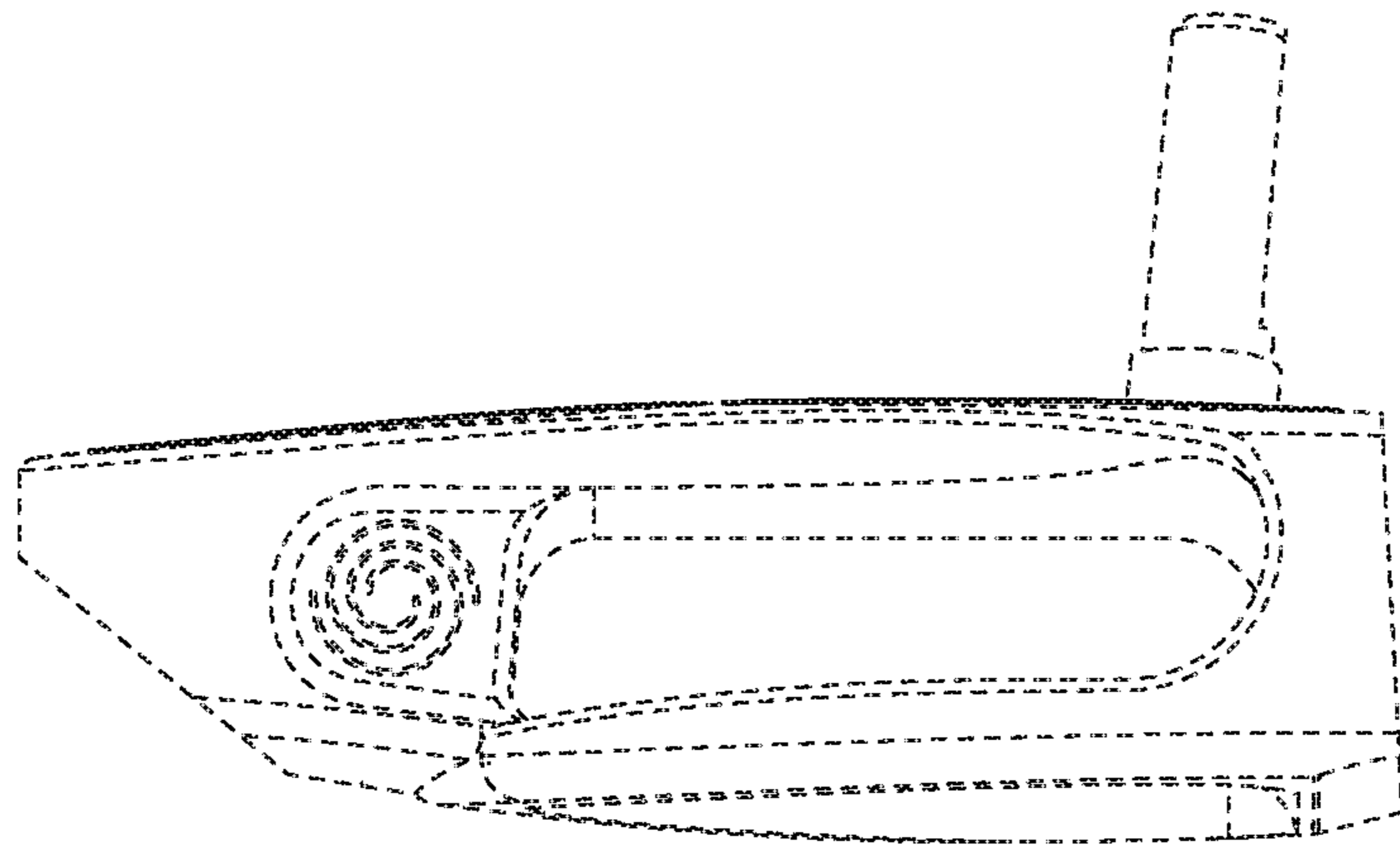

FIG. 9

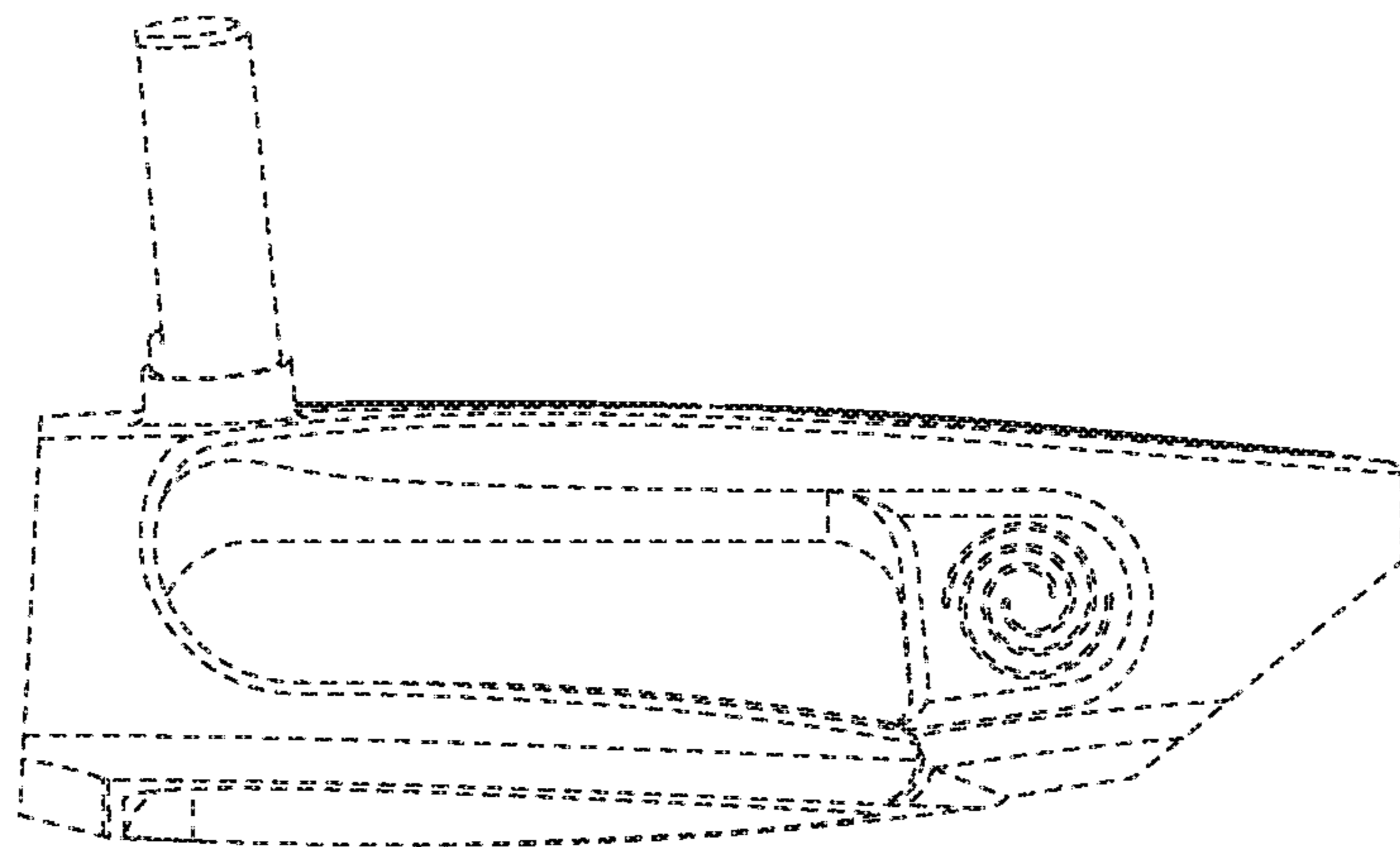

FIG. 10

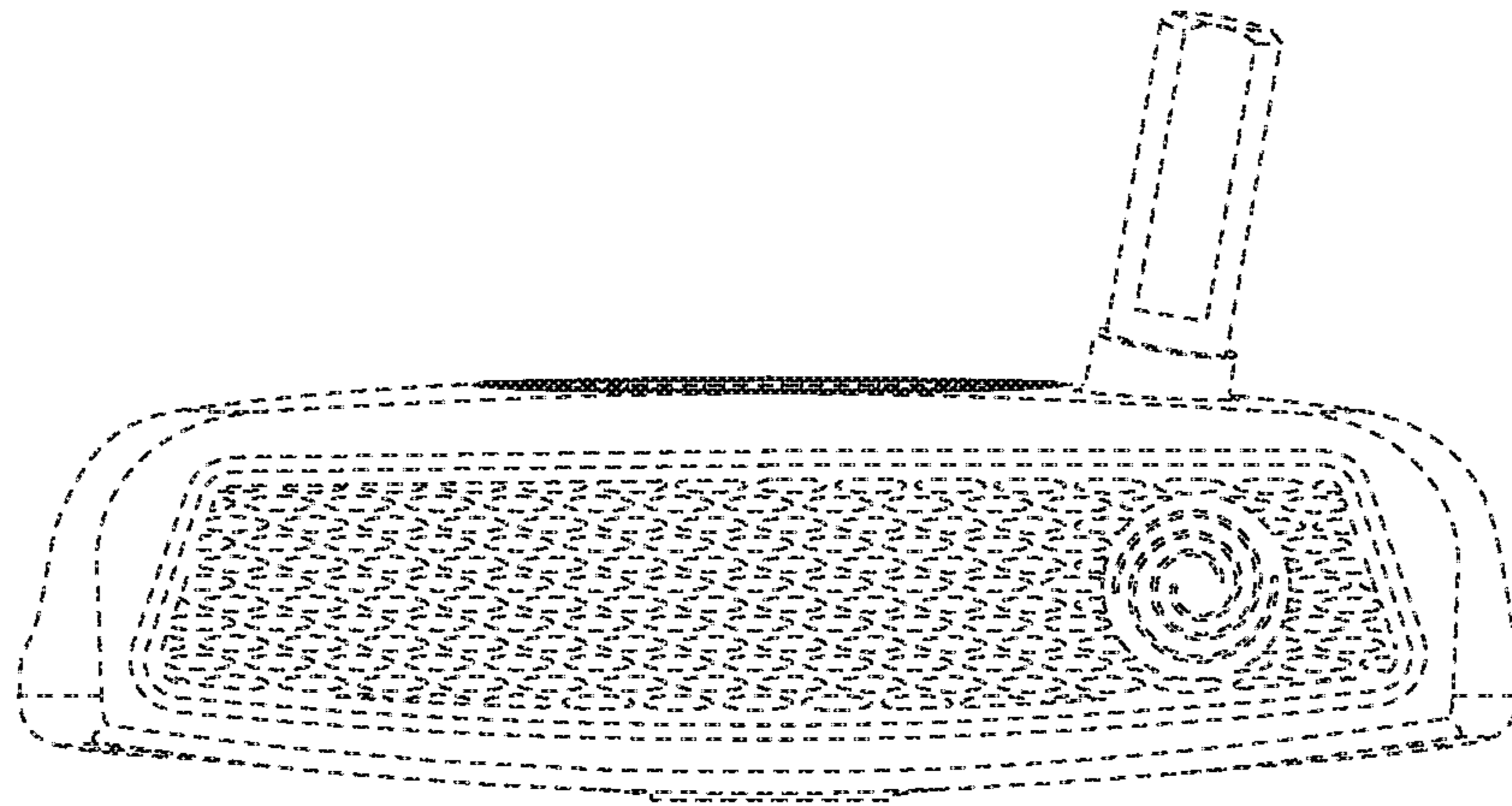

FIG. 11

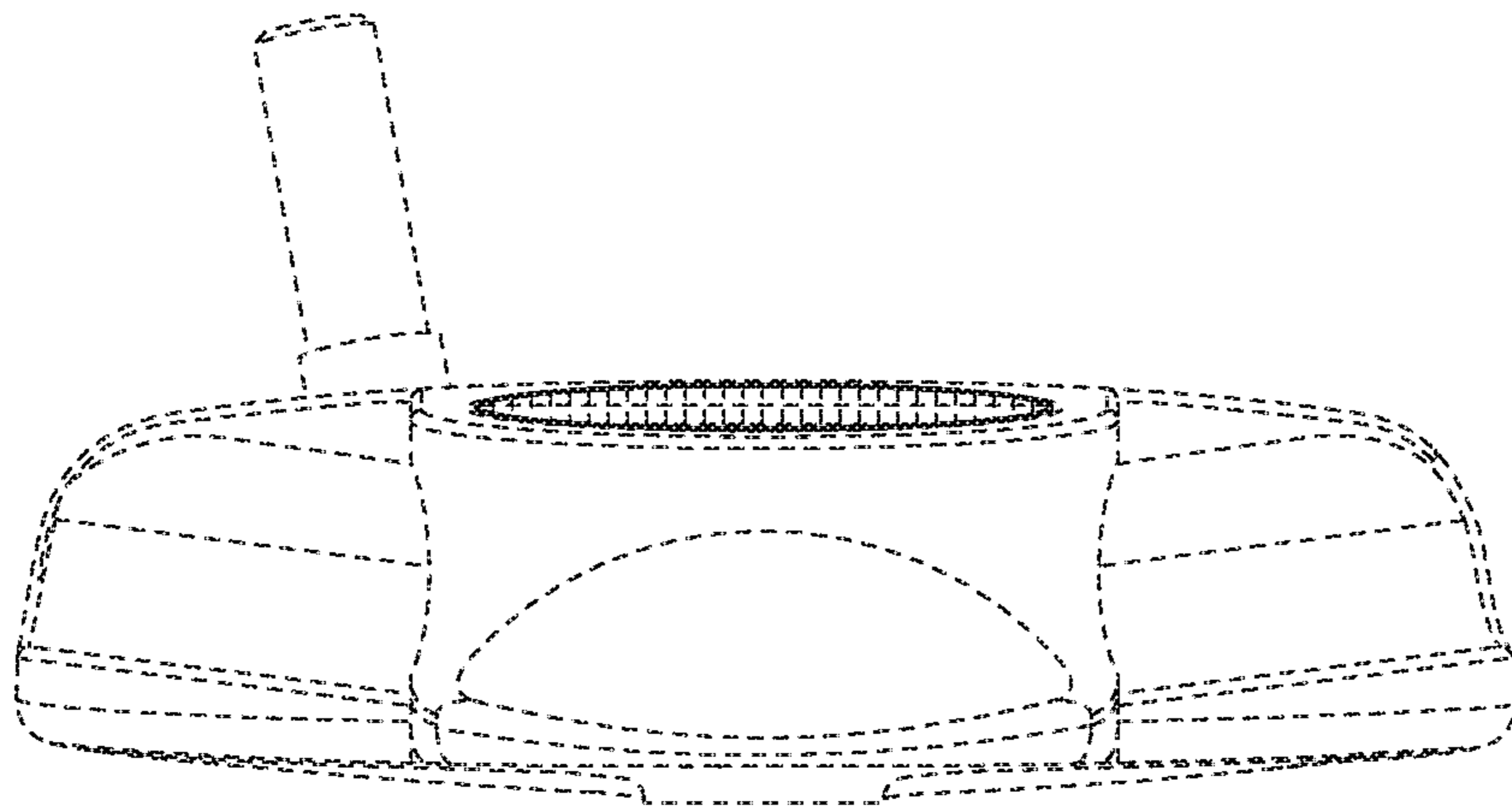

FIG. 12



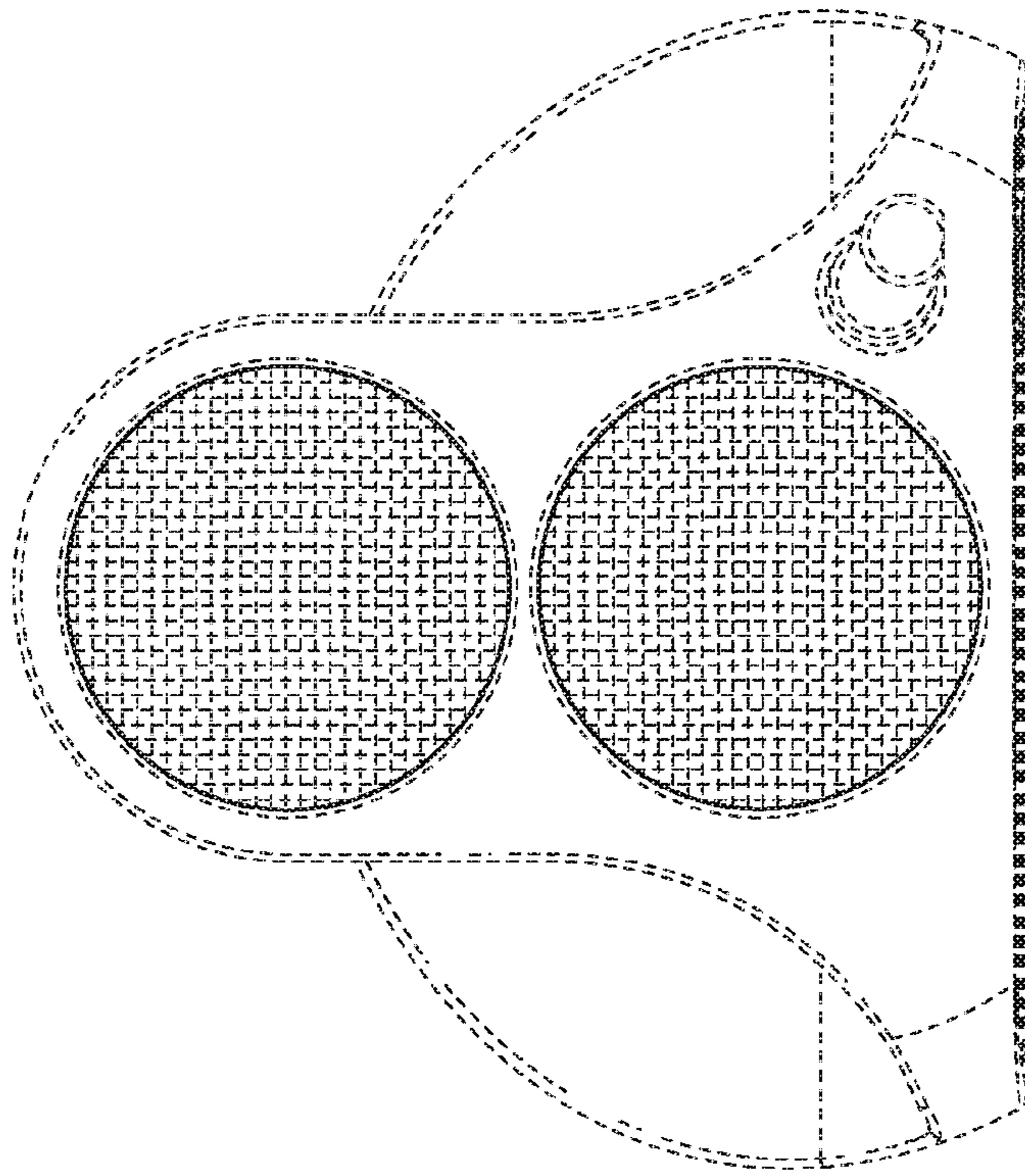

FIG. 13

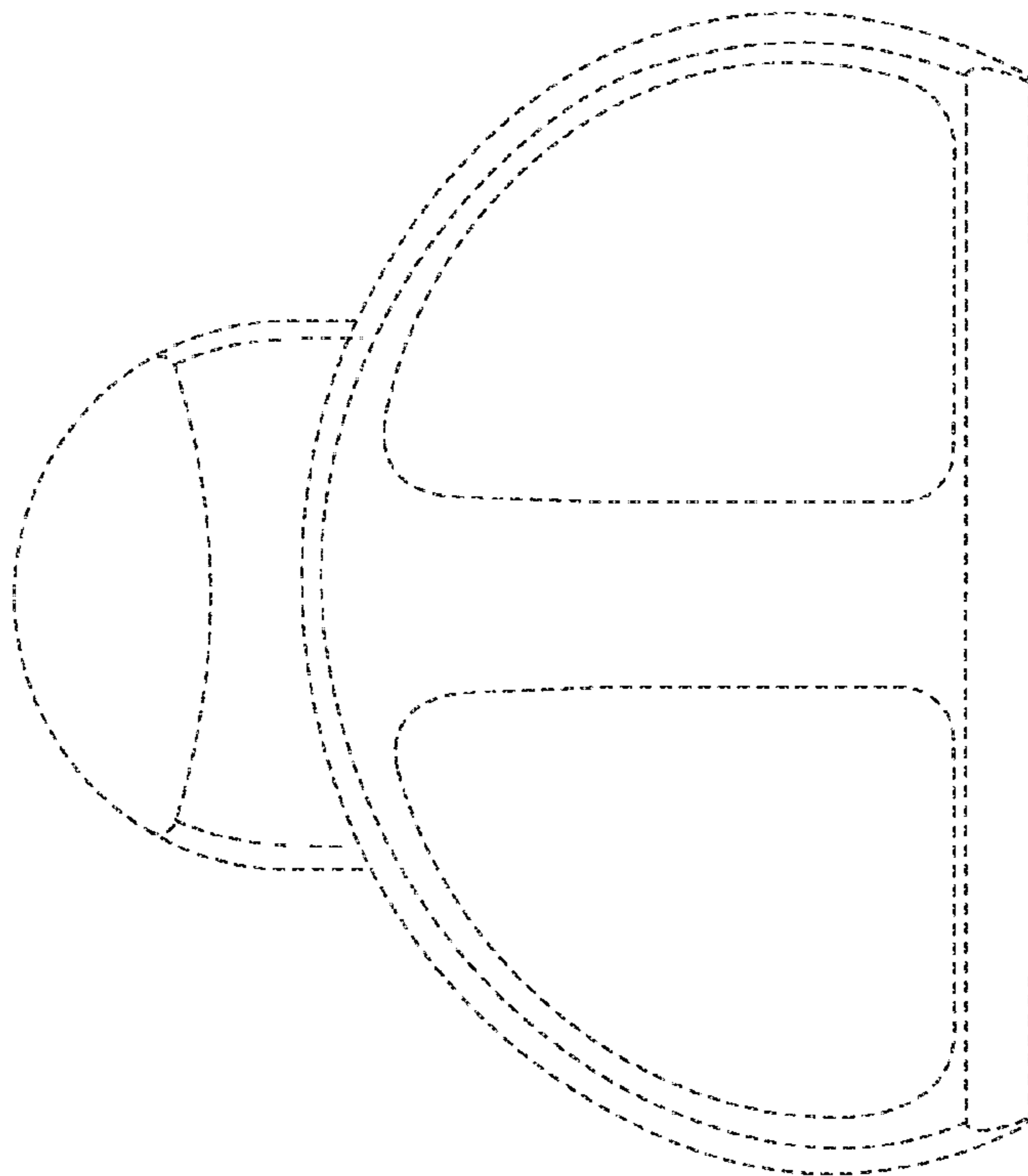

FIG. 14

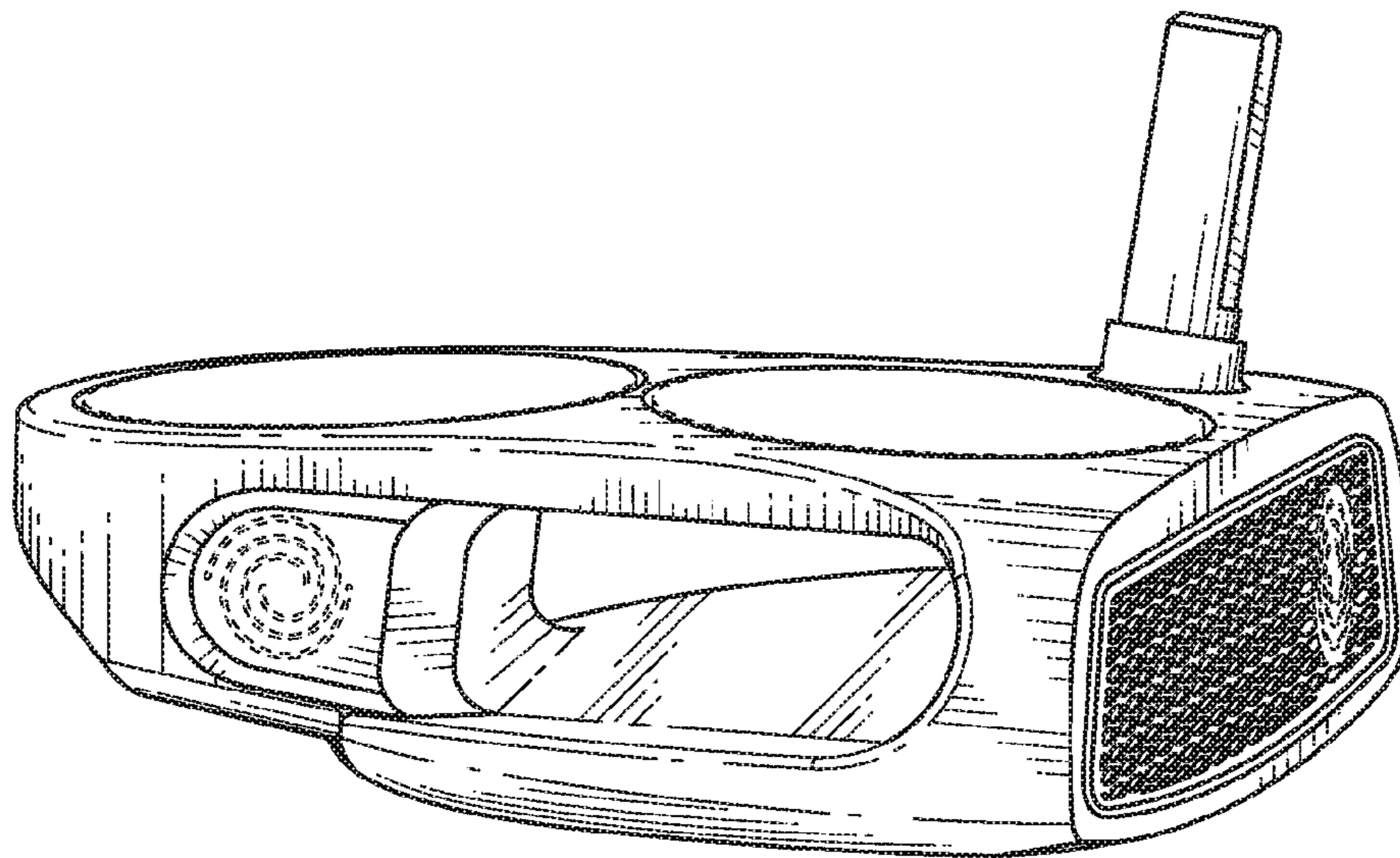

FIG. 15

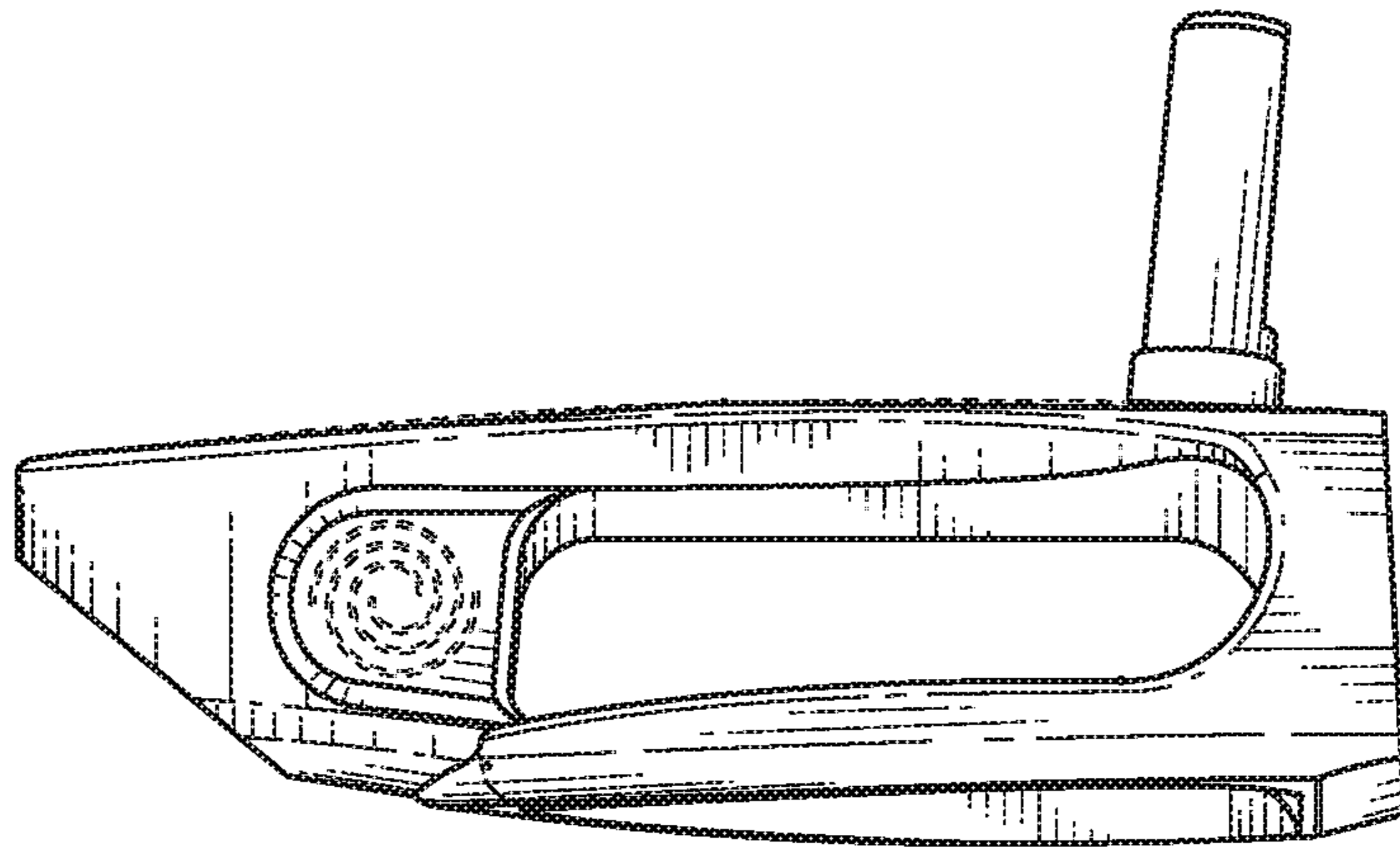

FIG. 16

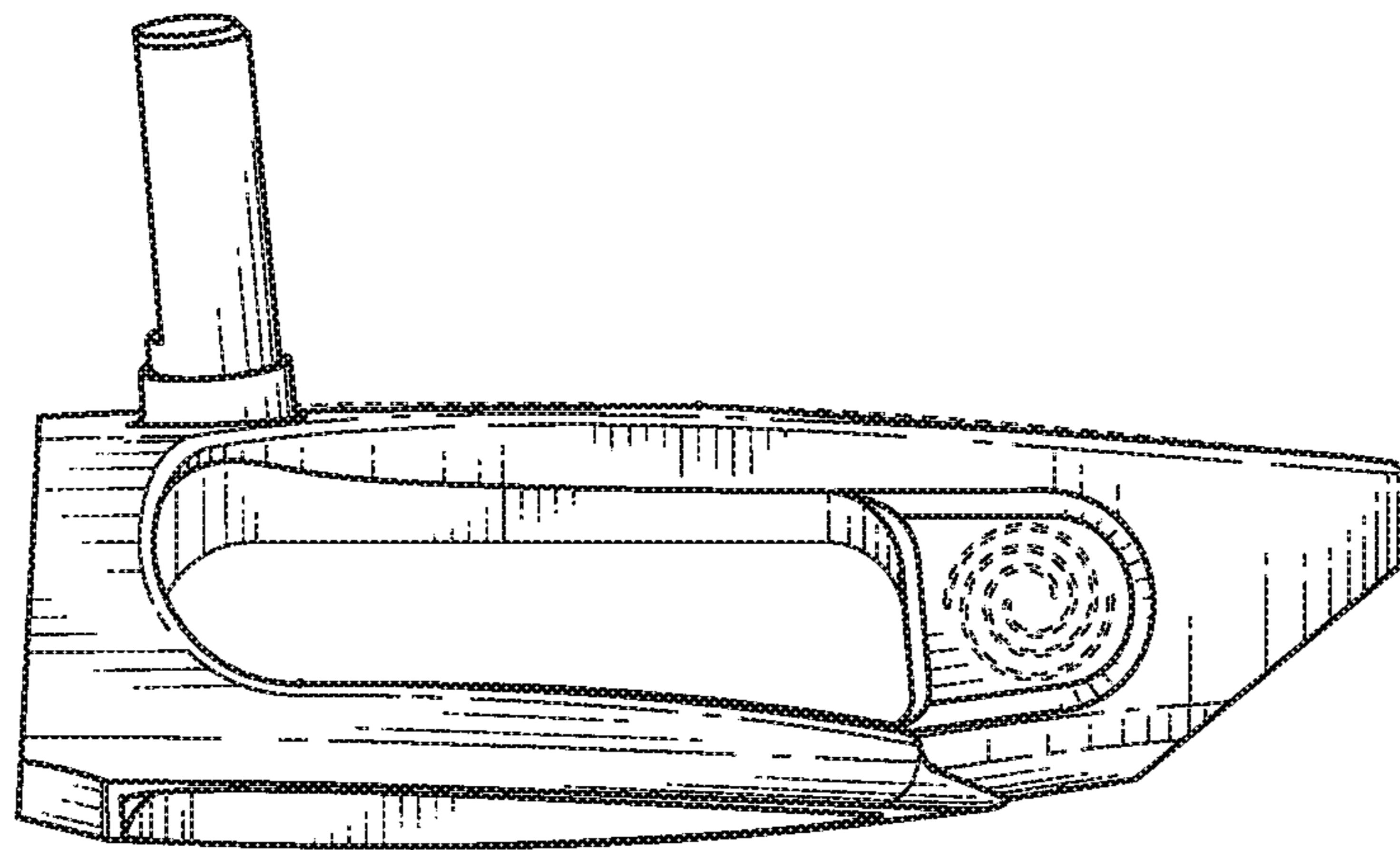

FIG. 17

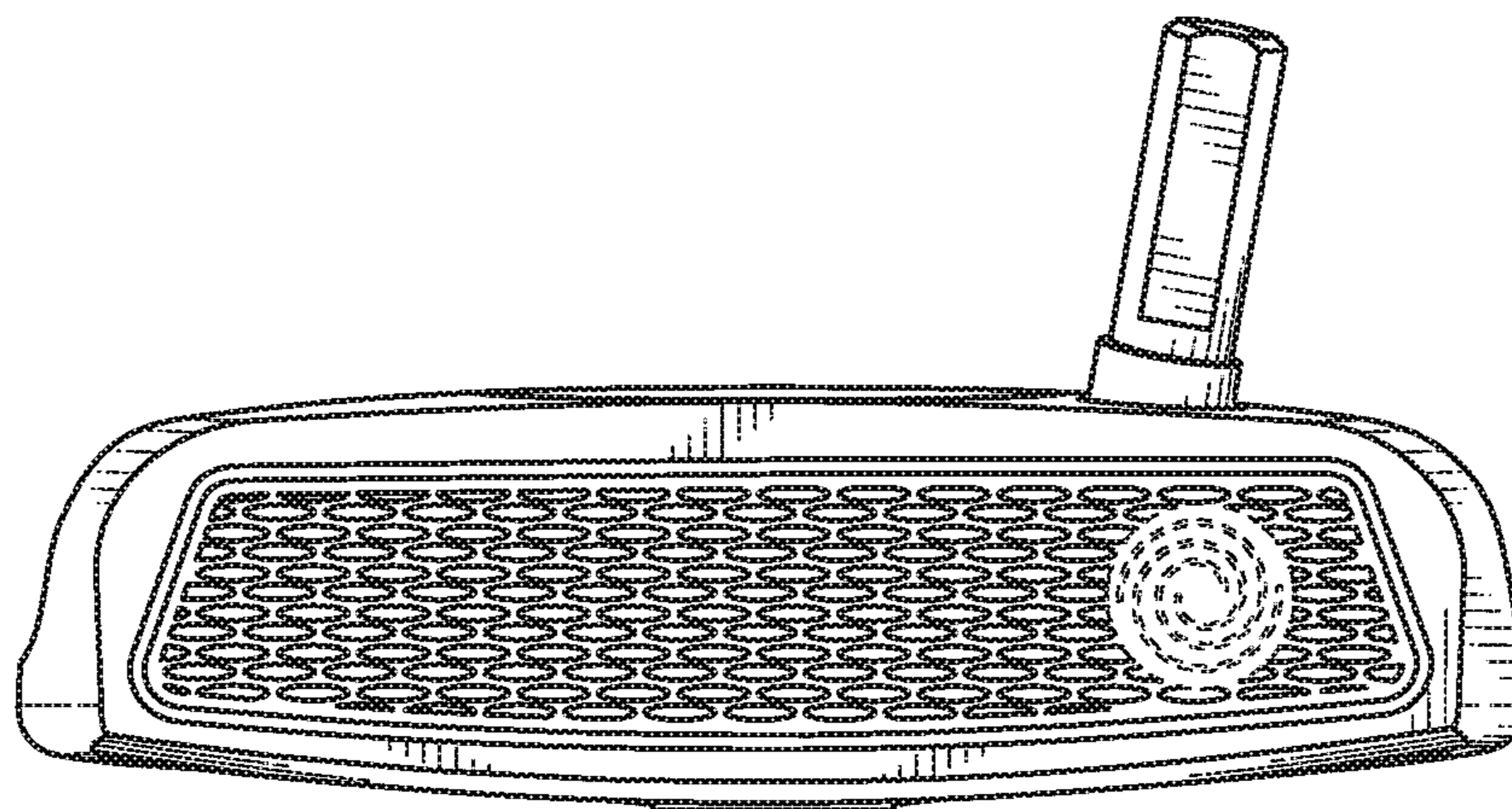

FIG. 18

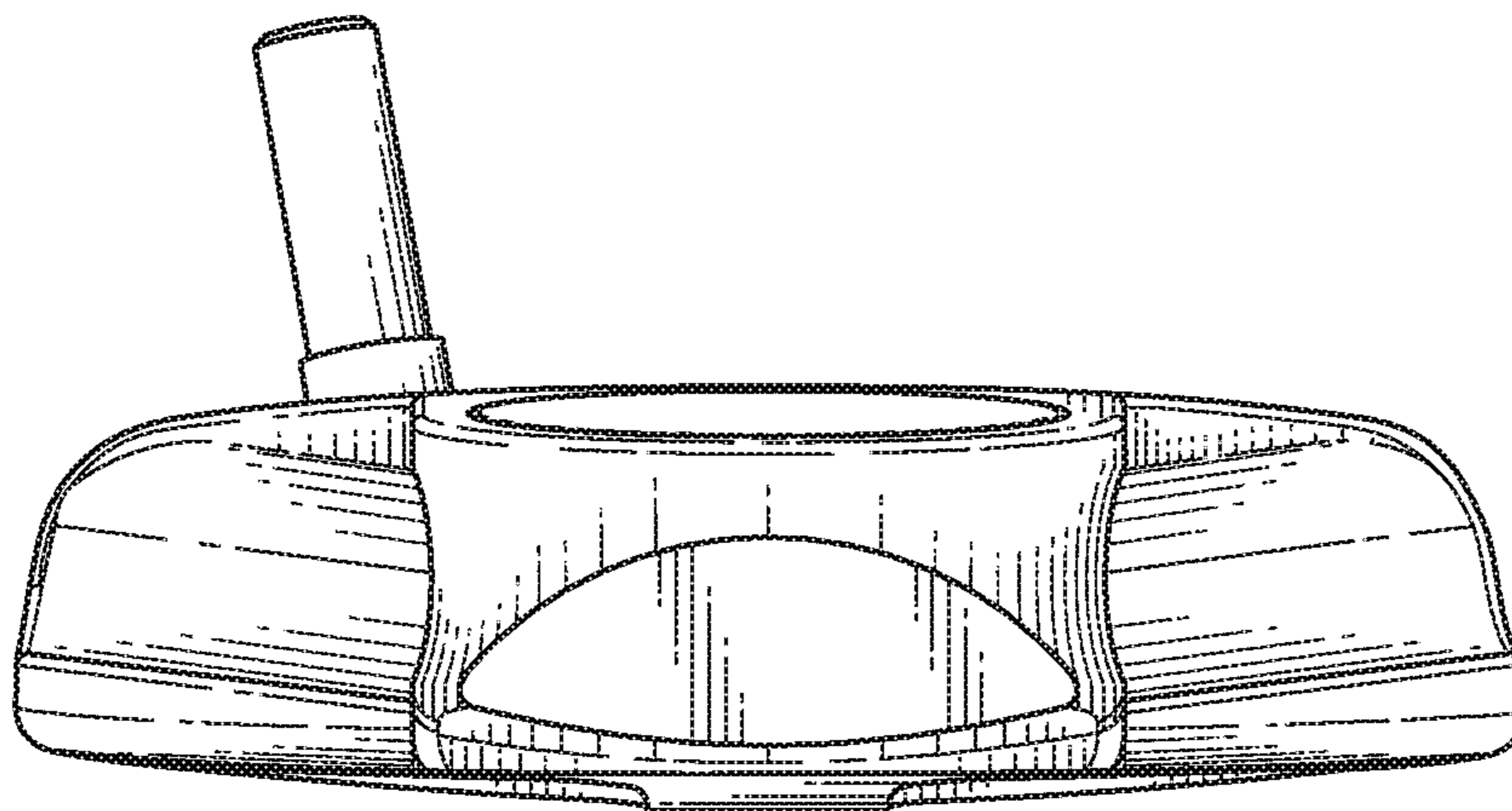

FIG. 19

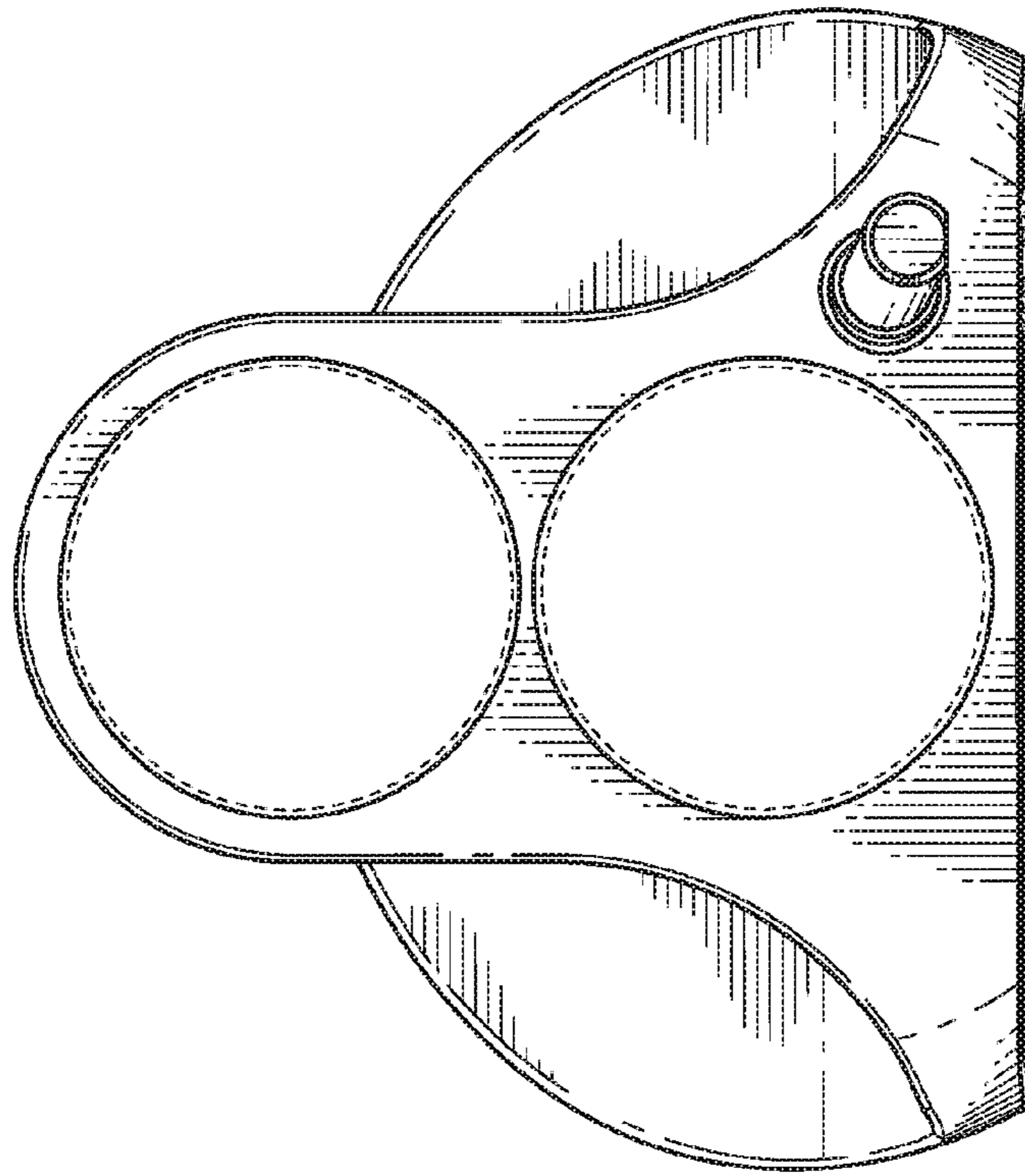

FIG. 20

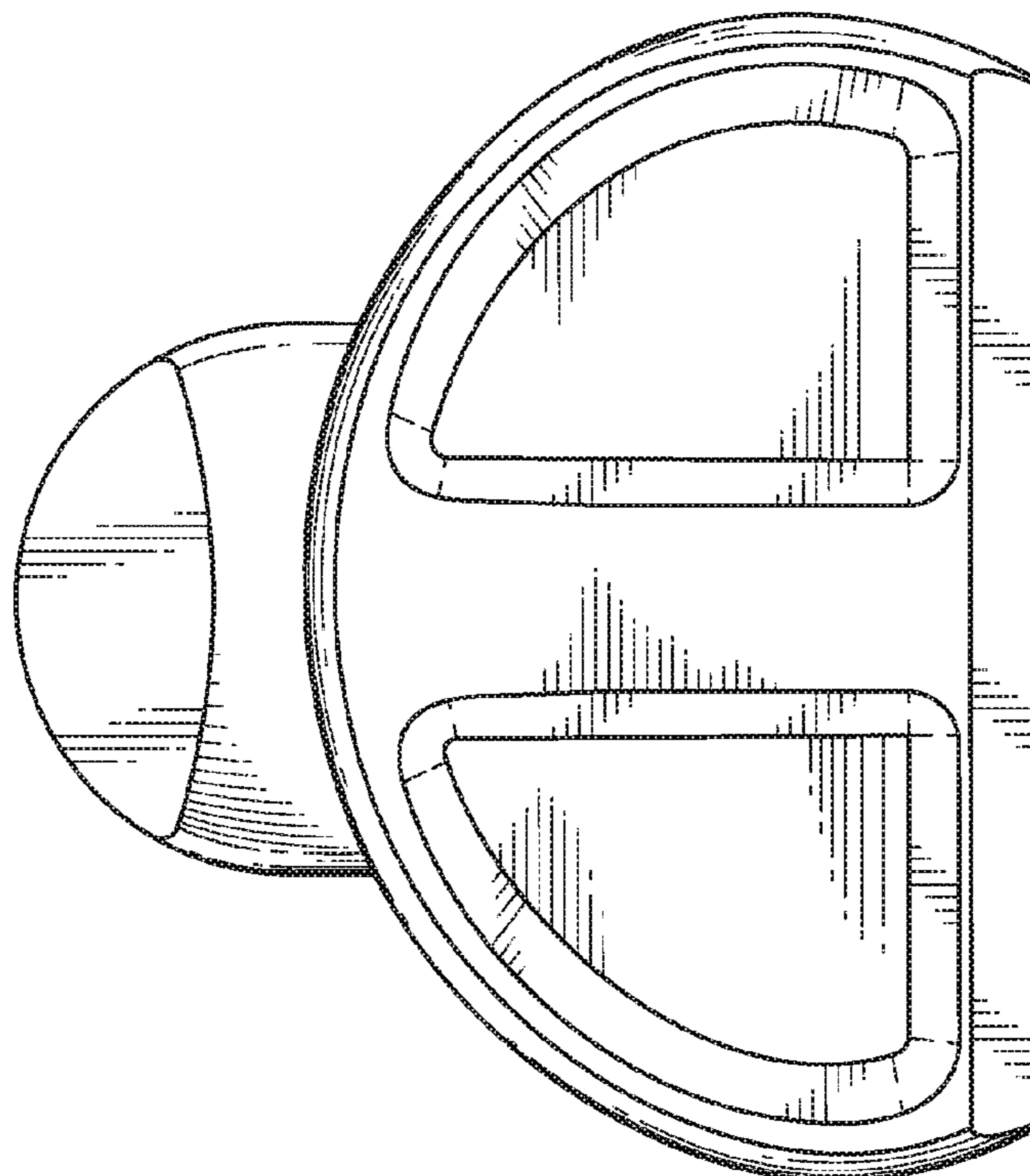

FIG. 21