



US00D704261S

(12) **United States Design Patent**  
**Kim et al.**

(10) **Patent No.:** **US D704,261 S**

(45) **Date of Patent:** **\*\* May 6, 2014**

(54) **PENCIL HOLDER**

(71) Applicant: **LG Hausys, Ltd.**, Seoul (KR)

(72) Inventors: **Tae-Woo Kim**, Yongin-si (KR);  
**Keun-Tae Kim**, Seoul (KR); **Han-Sung Choi**, Seoul (KR)

(73) Assignee: **LG Hausys, Ltd.**, Seoul (KR)

(\*\*) Term: **14 Years**

(21) Appl. No.: **29/454,688**

(22) Filed: **May 13, 2013**

(30) **Foreign Application Priority Data**

Mar. 14, 2013 (KR) ..... 30-2013-0012918

(51) **LOC (10) Cl.** ..... **19-06**

(52) **U.S. Cl.**  
USPC ..... **D19/85**

(58) **Field of Classification Search**

USPC ..... D3/206, 207, 310, 313; D6/672, 682.1,  
D6/682.2; D7/701-708; D19/75, 77-85,  
D19/91, 94, 97, 99, 100, 135; 24/3.6, 3.7;  
206/214, 224, 371; 211/69.1-69.9, 70  
See application file for complete search history.

(56) **References Cited**

**U.S. PATENT DOCUMENTS**

1,092,156 A \* 4/1914 Mathis ..... 206/207  
D233,086 S \* 10/1974 Gismondi ..... D6/416  
3,921,804 A \* 11/1975 Tester ..... 206/531  
D265,126 S \* 6/1982 Beall ..... D24/230  
4,446,982 A \* 5/1984 Corse ..... 220/8  
D300,290 S \* 3/1989 Moberg ..... D7/701  
D301,575 S \* 6/1989 Crawford, Jr. .... D13/119  
D323,447 S \* 1/1992 Booz ..... D7/705

D332,664 S \* 1/1993 Sincock ..... D24/227  
5,617,960 A \* 4/1997 Bishop ..... 211/60.1  
5,725,109 A \* 3/1998 Moulton et al. .... 211/73  
5,860,358 A \* 1/1999 Shriver ..... 99/426  
D408,058 S \* 4/1999 Isaacs ..... D19/85  
5,979,646 A \* 11/1999 Strachan ..... 206/217  
6,019,221 A \* 2/2000 Benja-Athon ..... 206/455  
D538,538 S \* 3/2007 Espinosa ..... D3/313  
D551,036 S \* 9/2007 Tomaszewski ..... D7/701  
D553,902 S \* 10/2007 Barber ..... D7/357  
D597,370 S \* 8/2009 Watkins ..... D7/354  
D621,639 S \* 8/2010 Merrick ..... D6/469  
D636,642 S \* 4/2011 Dulin ..... D7/701  
D647,667 S \* 10/2011 Siklosi ..... D30/133

\* cited by examiner

*Primary Examiner* — Elizabeth Albert

(74) *Attorney, Agent, or Firm* — Lowe Hauptman & Ham, LLP

(57) **CLAIM**

The ornamental design for a pencil holder, as shown and described.

**DESCRIPTION**

FIG. 1 is a perspective view showing the pencil holder claimed in this application.

FIG. 2 is a front view showing the claimed design;

FIG. 3 is a rear view showing the claimed design;

FIG. 4 a left side view showing the claimed design;

FIG. 5 is a right side view showing the claimed design;

FIG. 6 is a top plan view showing the claimed design;

FIG. 7 is a bottom plan view showing the claimed design; and,

FIG. 8 is a reference view showing the claimed design with pencils held therein.

The broken lines showing pencils in FIG. 8 are included to show features in the environment that form no part of the claimed design.

**1 Claim, 8 Drawing Sheets**

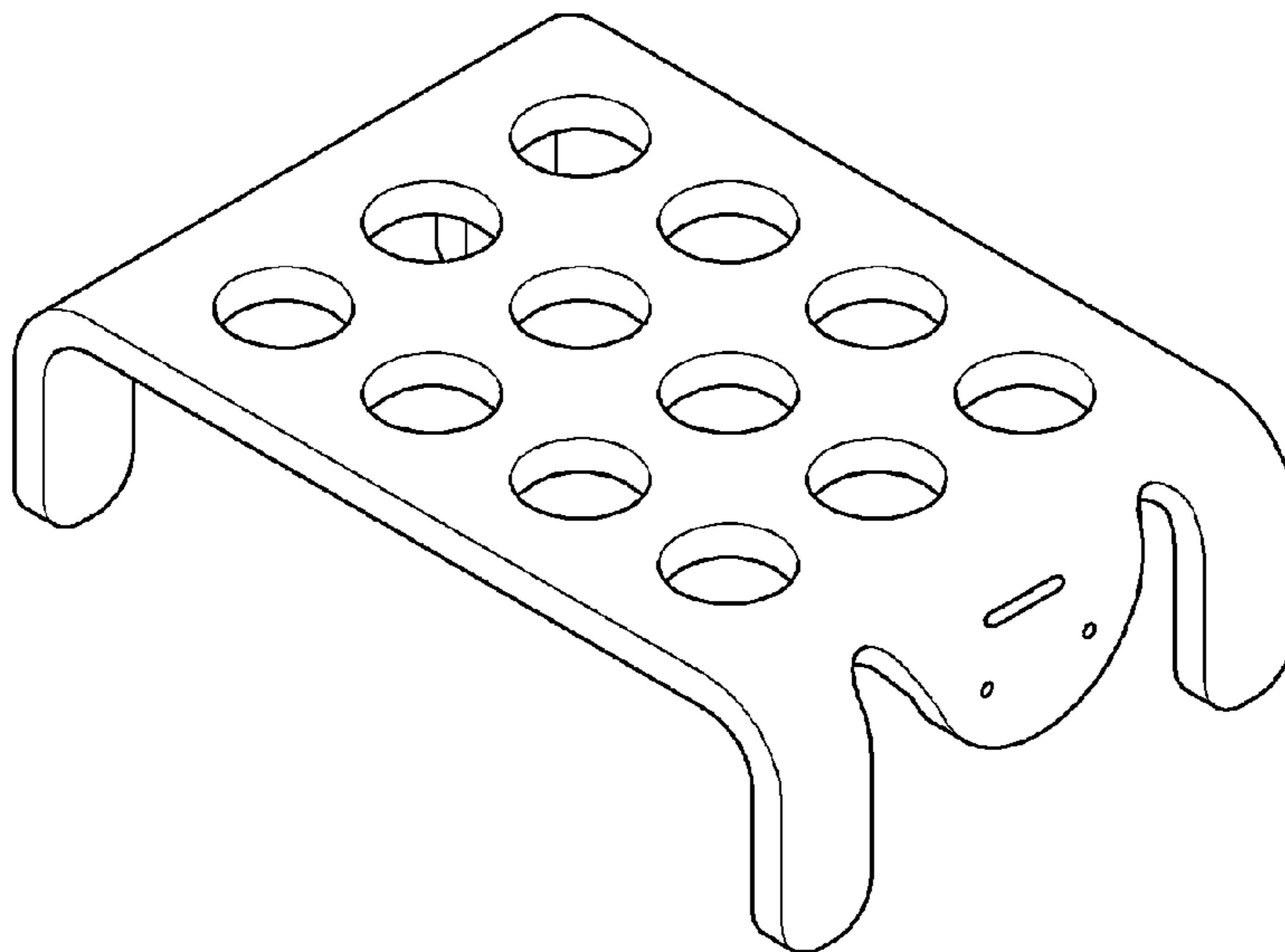

FIG. 1

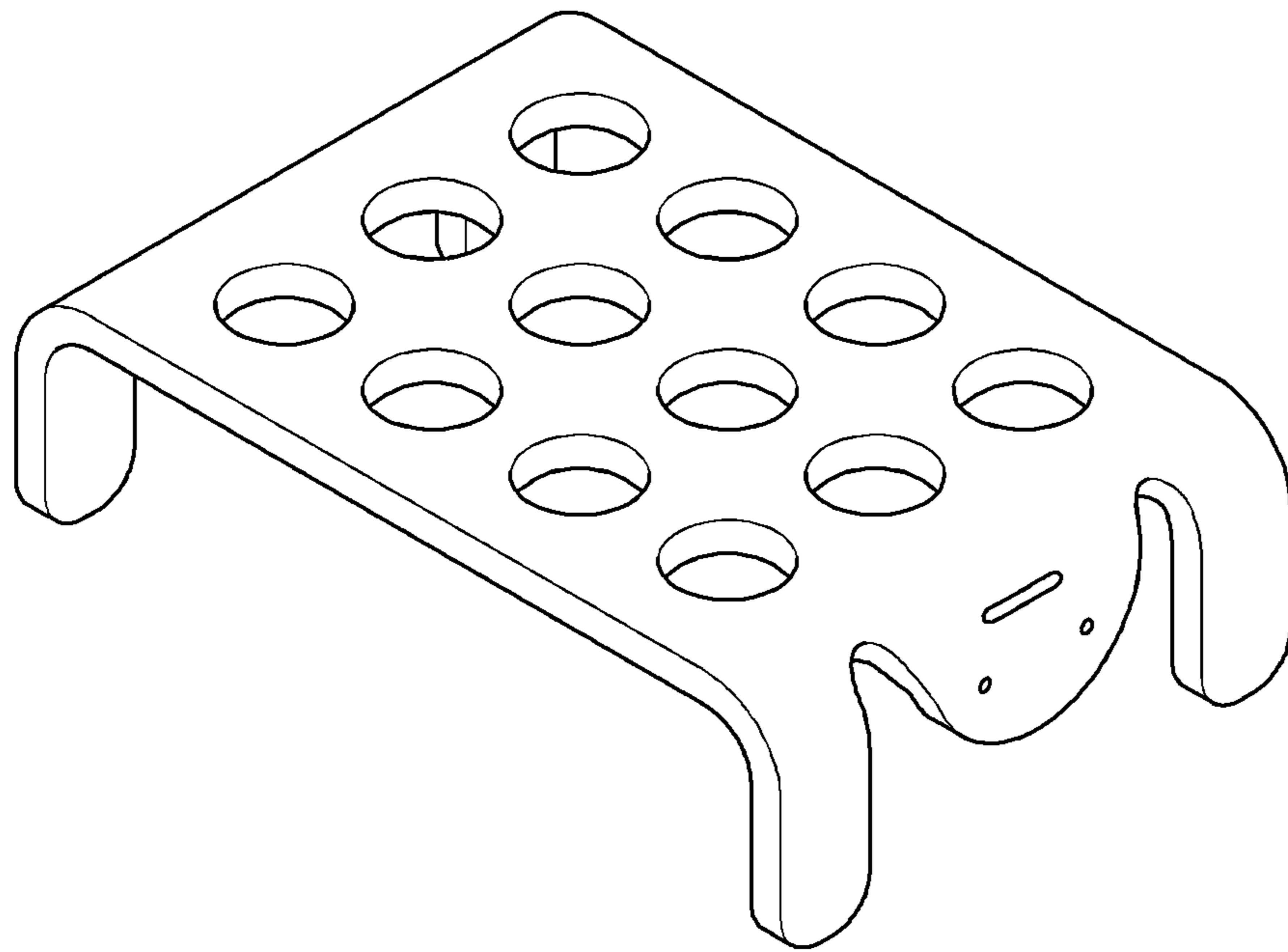

FIG. 2

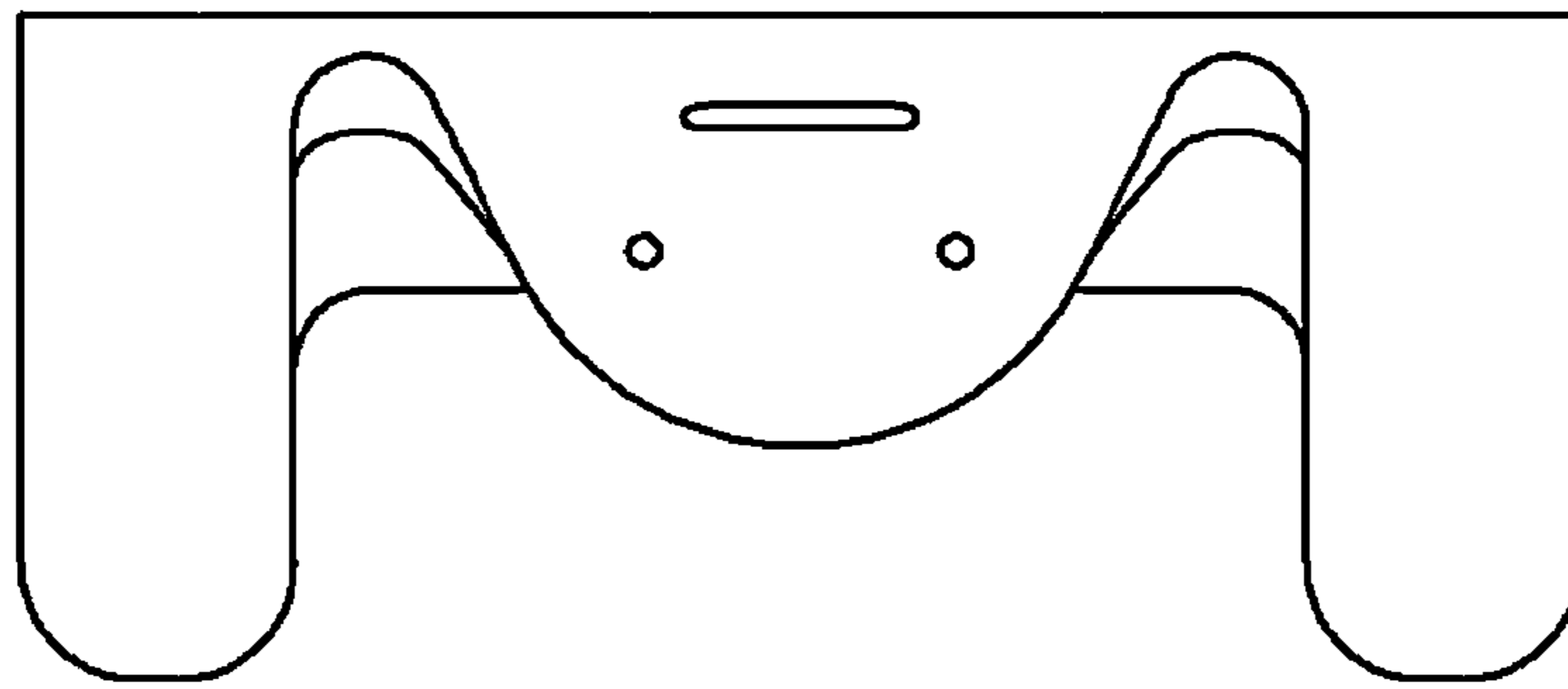
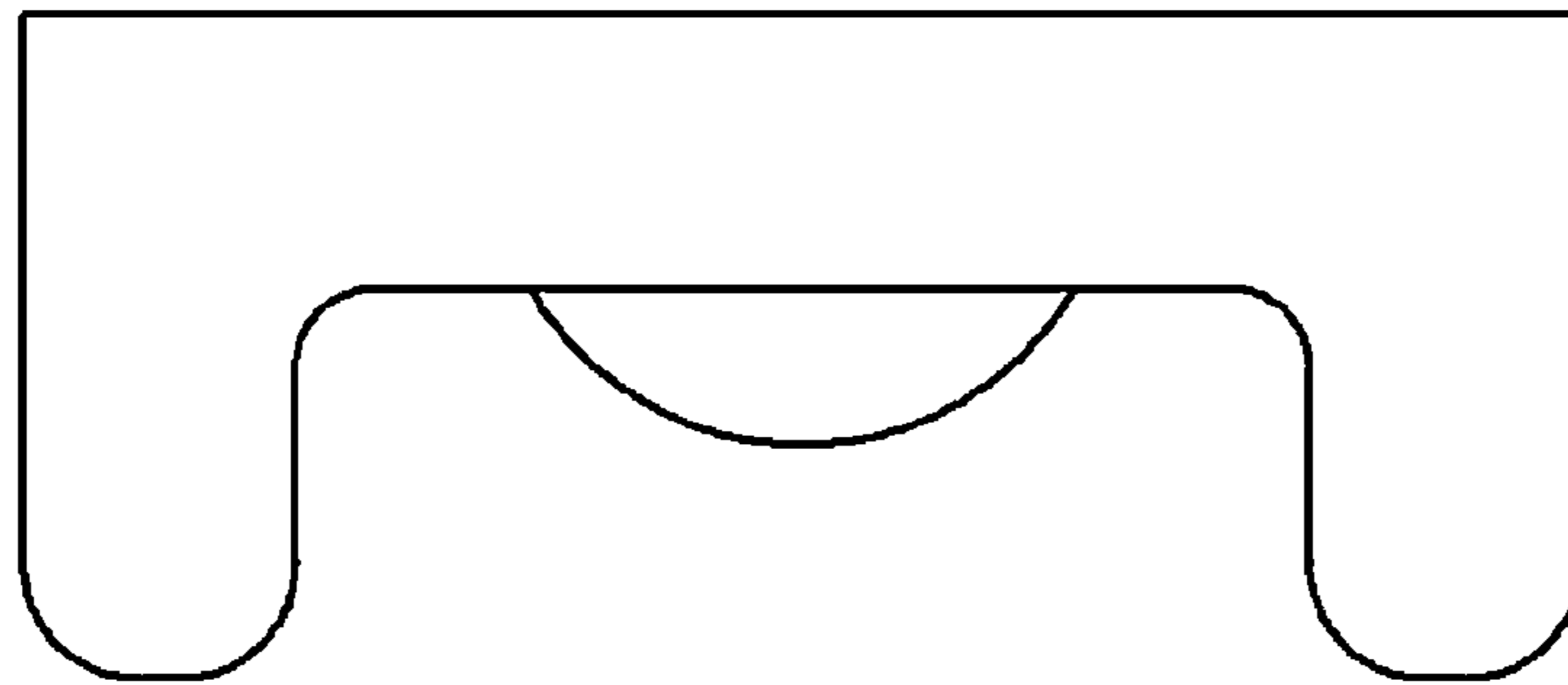
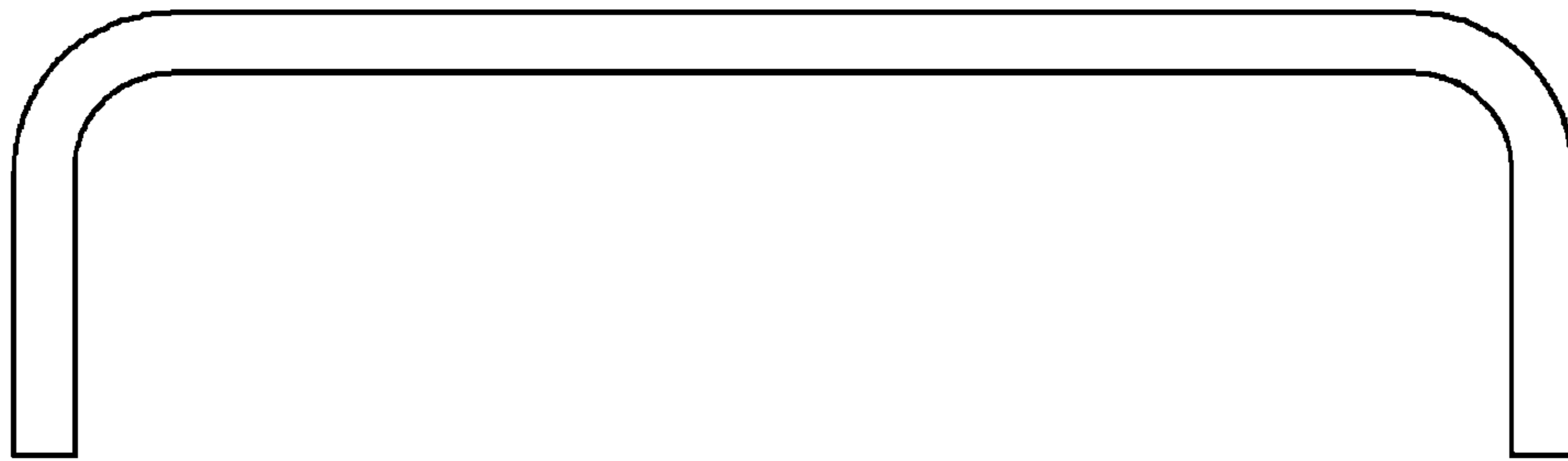

FIG. 3



**FIG. 4**



**FIG. 5**

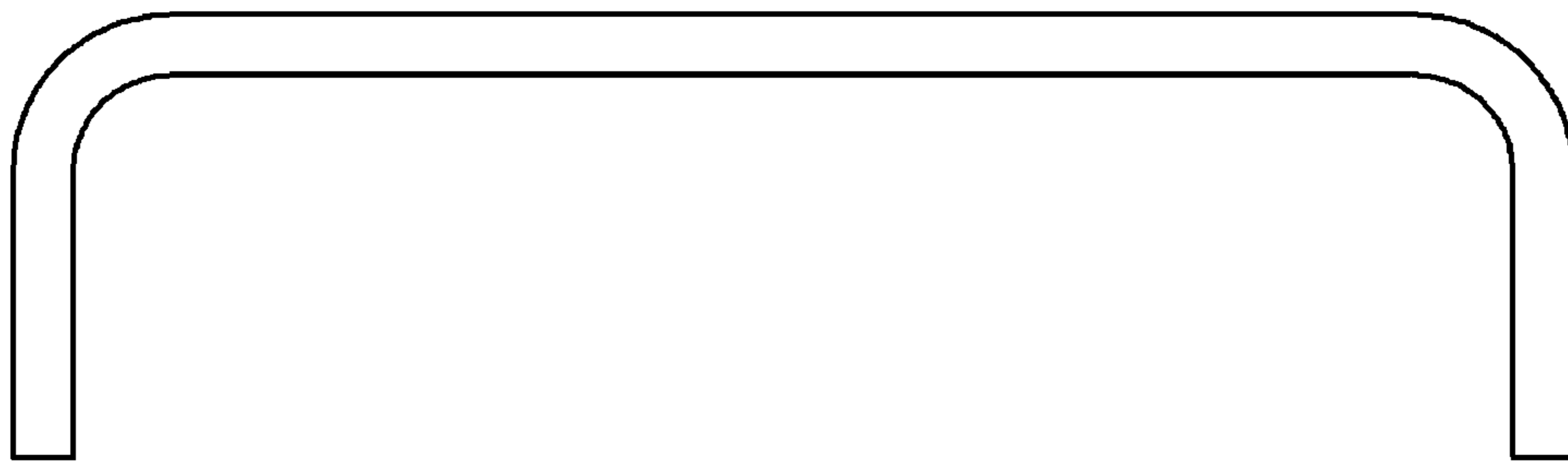

**FIG. 6**

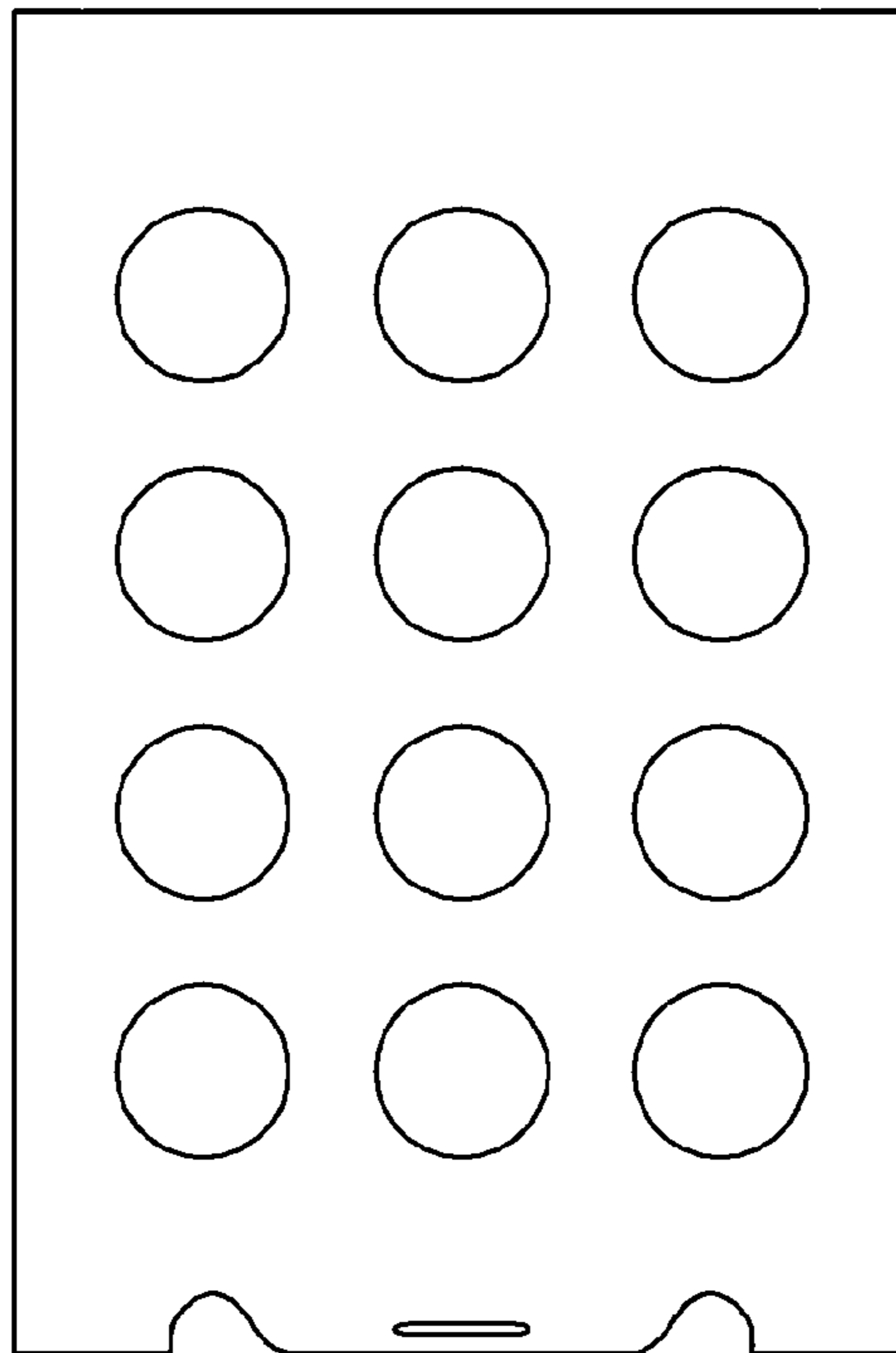

**FIG. 7**

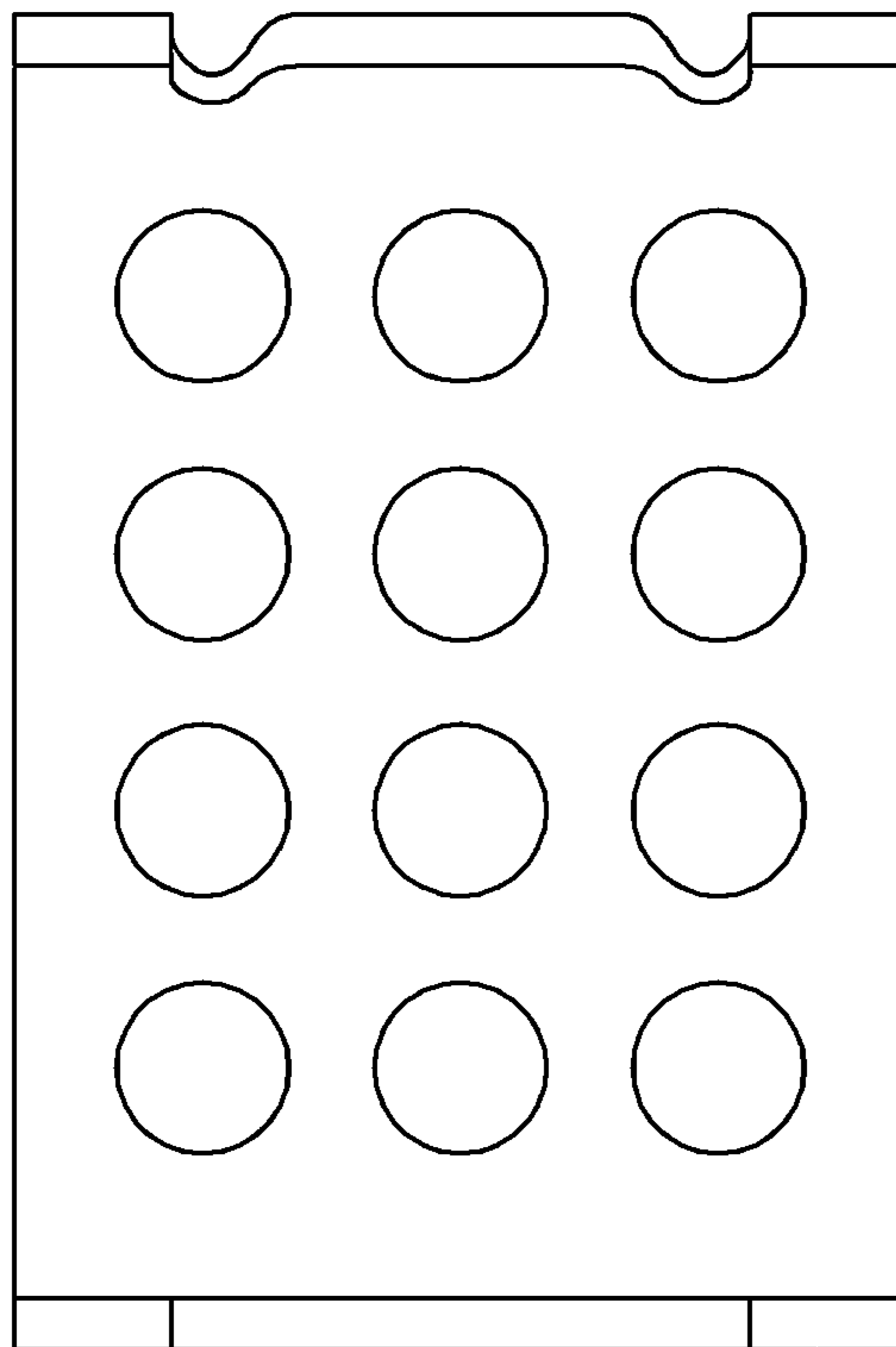



FIG. 8

