



US00D704133S

(12) **United States Design Patent**
Xu et al.

(10) **Patent No.:** **US D704,133 S**

(45) **Date of Patent:** **** May 6, 2014**

(54) **RECHARGEABLE BATTERY PACK**

(75) Inventors: **Ning Xu**, Nanjing (CN); **Deshun Chen**,
Nanjing (CN); **Hua Jiang**, Sharon, MA
(US)

(73) Assignee: **Nanjing Optron Scientific, Inc. Ltd.**,
Nanjing, Jiangsu (CN)

(**) Term: **14 Years**

(21) Appl. No.: **29/391,311**

(22) Filed: **May 6, 2011**

(51) **LOC (10) Cl.** **13-02**

(52) **U.S. Cl.**
USPC **D13/103**

(58) **Field of Classification Search**
USPC D13/102–108, 110, 118–121, 184, 199;
429/96–100, 163, 176
See application file for complete search history.

(56) **References Cited**

U.S. PATENT DOCUMENTS

3,829,332	A *	8/1974	Iizuka et al.	429/97
4,510,215	A *	4/1985	Adam	429/99
D303,373	S *	9/1989	Ching, Jr.	D13/103
D304,926	S *	12/1989	Ching, Jr.	D13/103
D304,927	S *	12/1989	Ching et al.	D13/103
D384,031	S *	9/1997	Lui	D13/103
6,174,618	B1 *	1/2001	Nishiyama et al.	429/99
D439,878	S *	4/2001	Ark et al.	D13/103
D455,711	S *	4/2002	Fuhr et al.	D13/103
D474,446	S *	5/2003	Eager et al.	D13/103

D531,117	S *	10/2006	Schrack et al.	D13/103
D539,215	S *	3/2007	Yoshikawa et al.	D13/103
D604,235	S *	11/2009	Tarter	D13/103
7,749,643	B2 *	7/2010	Tsai	429/100
D635,507	S *	4/2011	Ueda et al.	D13/103
D640,629	S *	6/2011	Levitt	D13/103
D642,120	S *	7/2011	Kretschmer	D13/103

* cited by examiner

Primary Examiner — Rosemary K Tarcza

(57) **CLAIM**

The ornamental design for a rechargeable battery pack, as shown and described.

DESCRIPTION

FIG. 1 is a perspective view of a rechargeable battery pack showing our new design;
FIG. 2 is a top view thereof;
FIG. 3 is a front view thereof;
FIG. 4 is a rear view thereof;
FIG. 5 is a left view thereof;
FIG. 6 is a right view thereof;
FIG. 7 is a bottom view thereof; and,
FIG. 8 is a perspective view of a rechargeable battery pack as a counterweight with a telescope mount thereof. The broken lines showing the telescope mount in the drawings are included for the purpose of illustrating environmental structure and form no part of the claimed design.

1 Claim, 5 Drawing Sheets

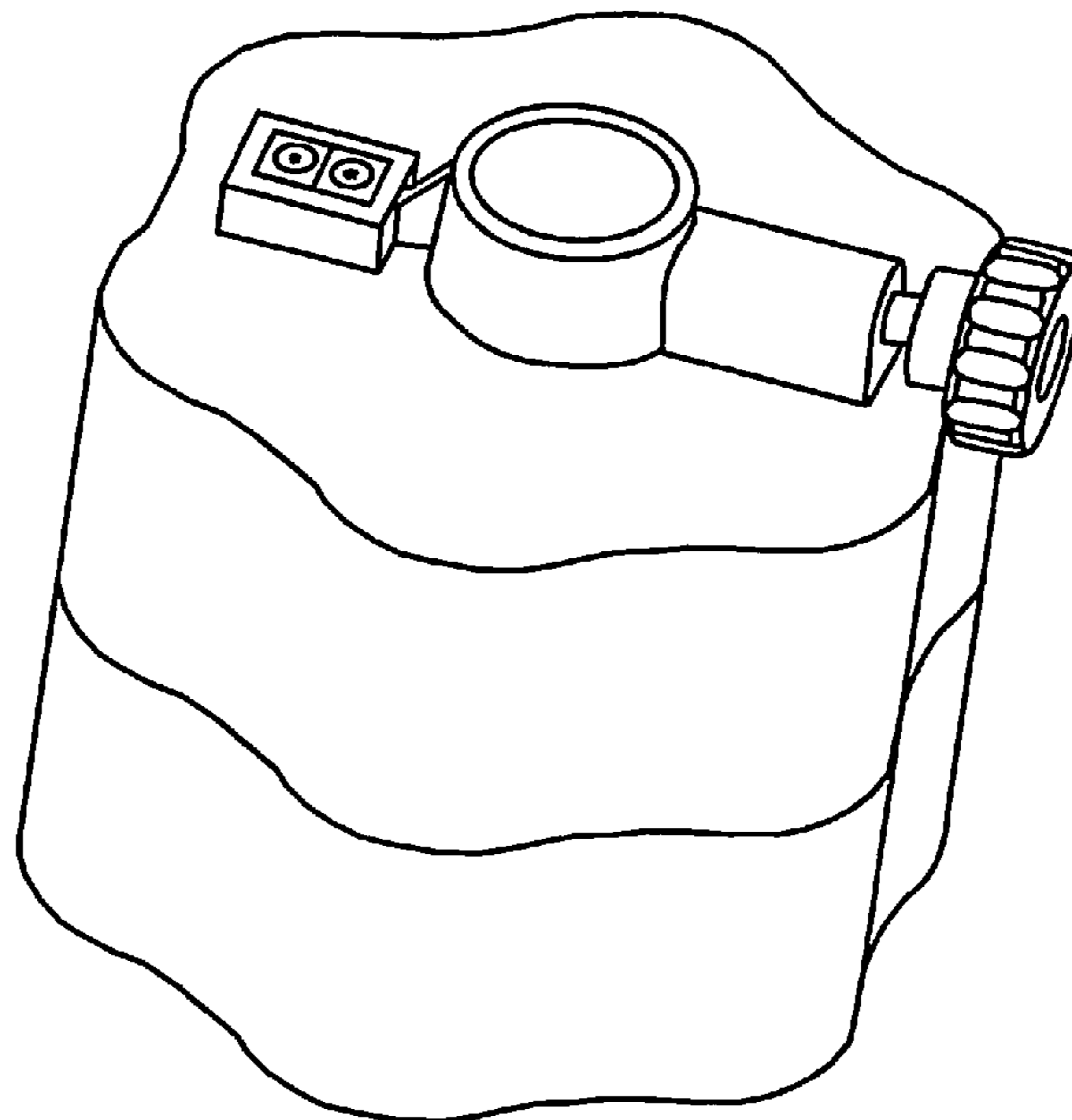

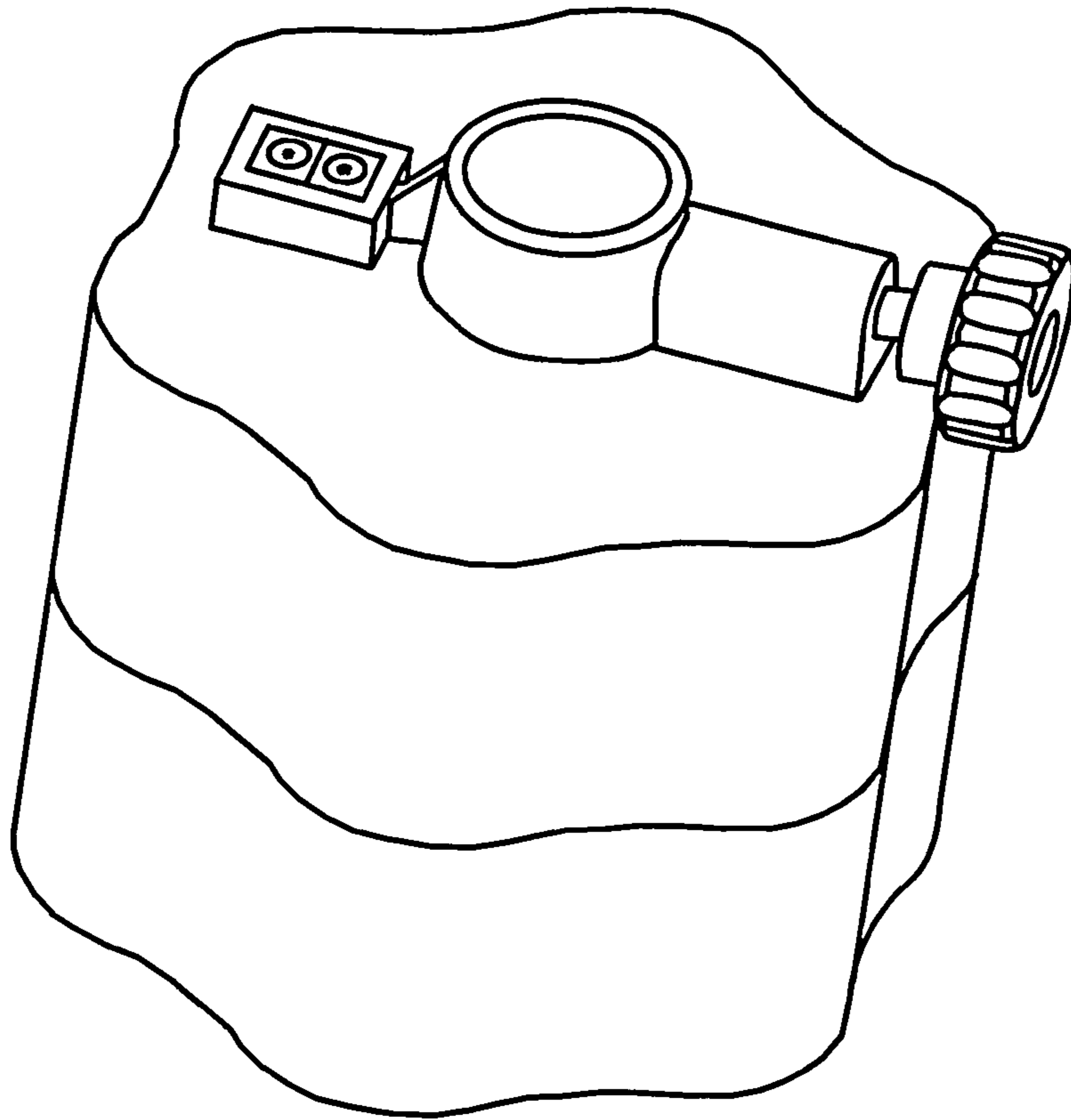

FIG. 1 (Amended)

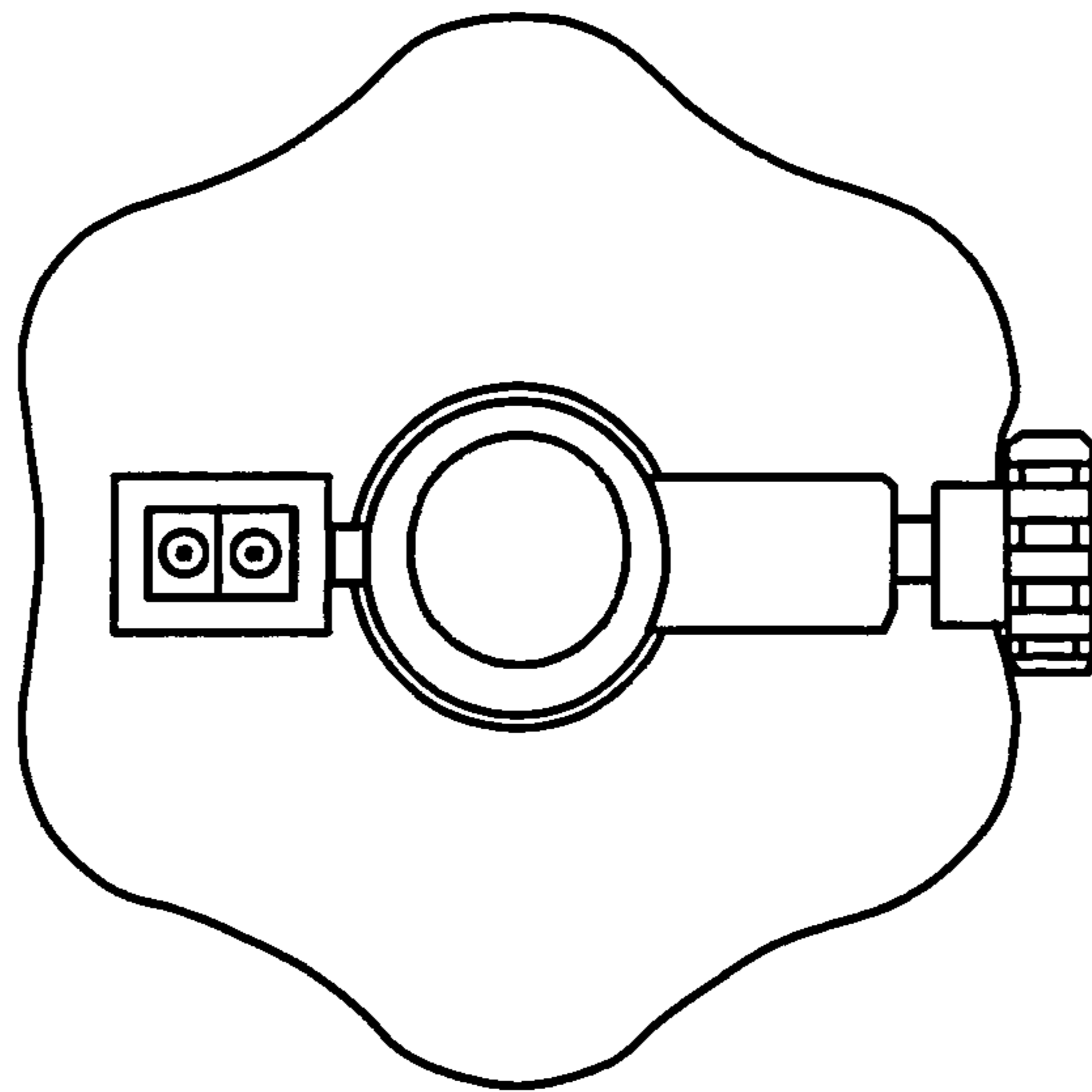

FIG. 2

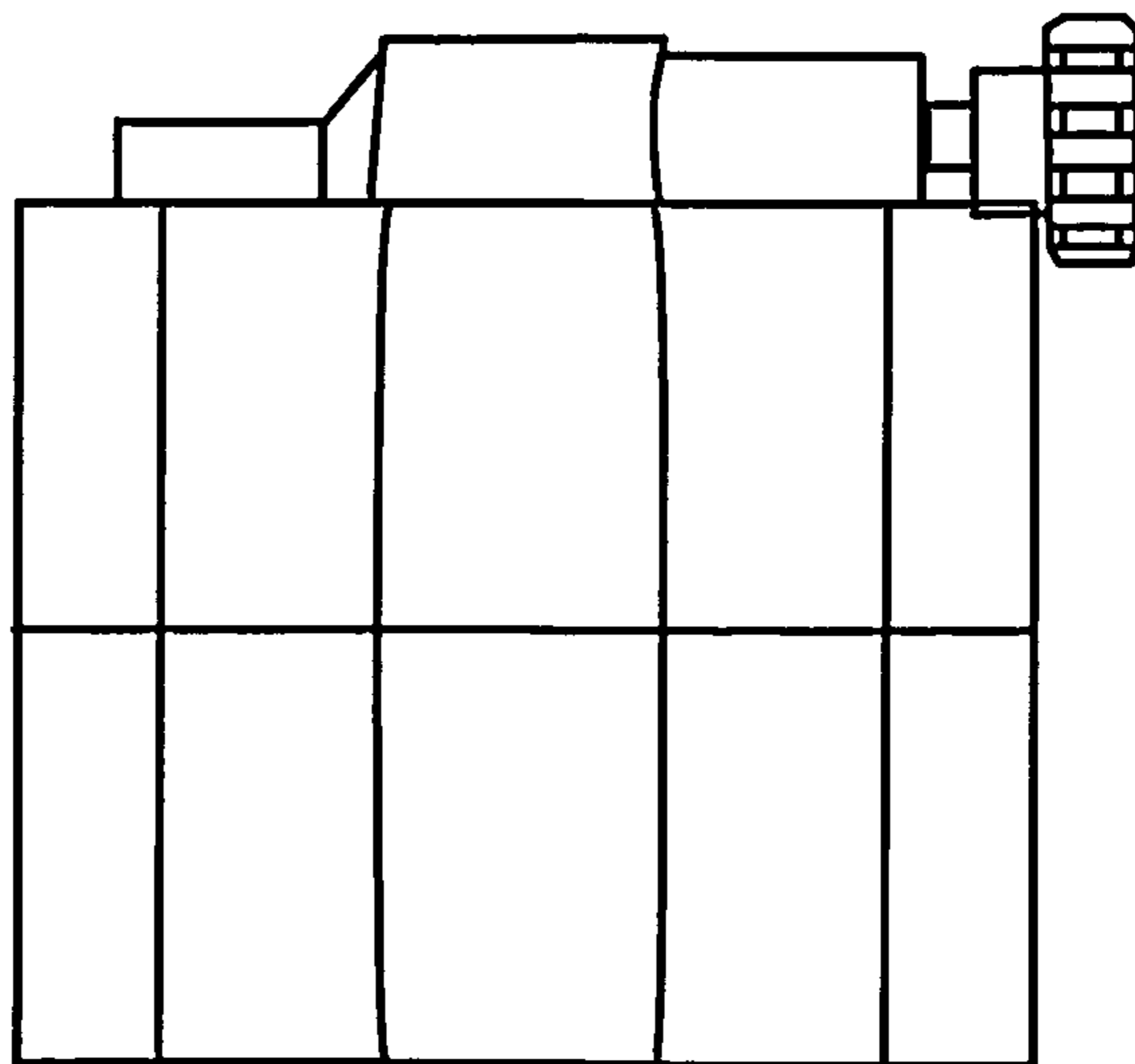

FIG. 3

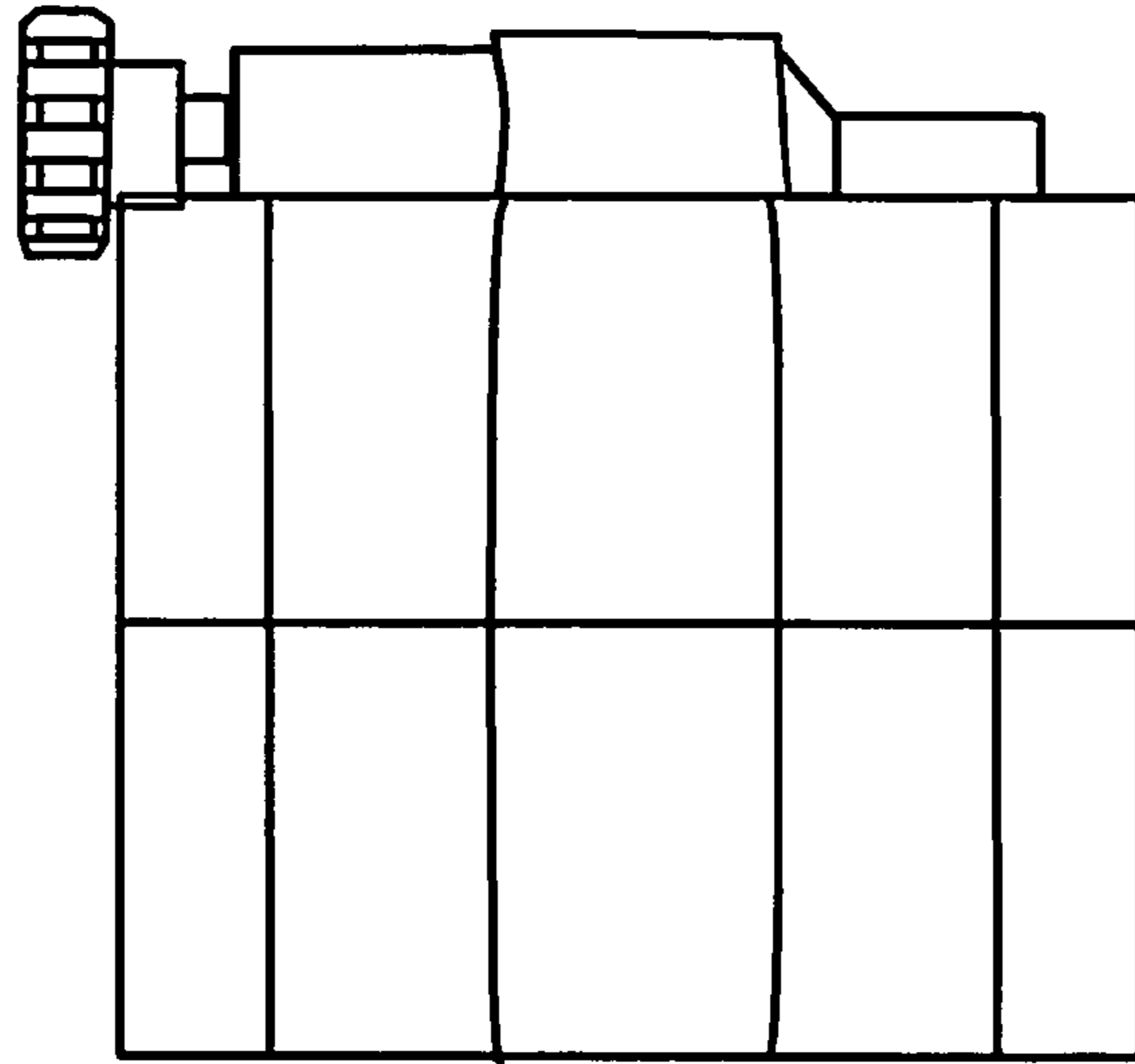

FIG. 4

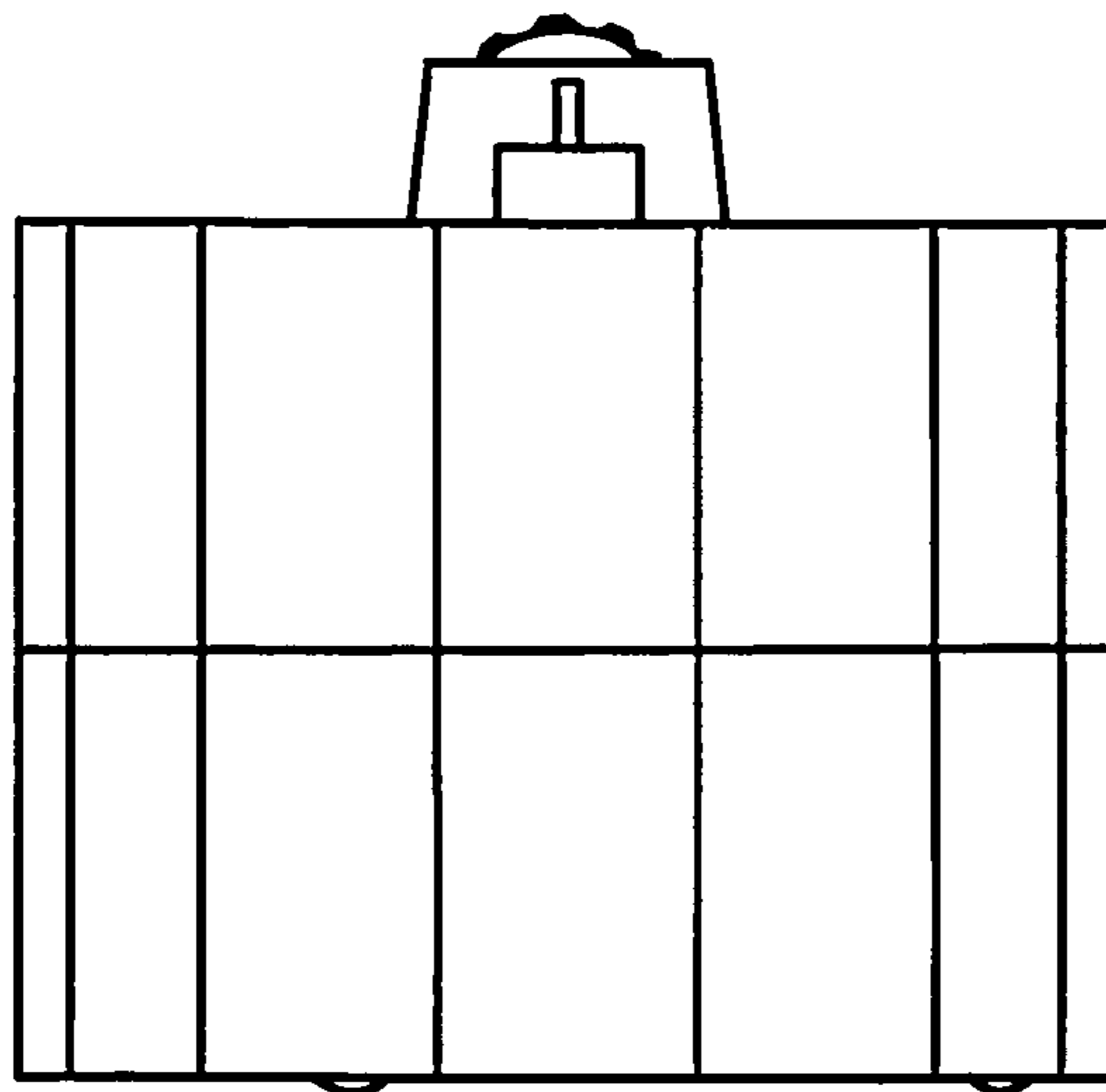

FIG. 5

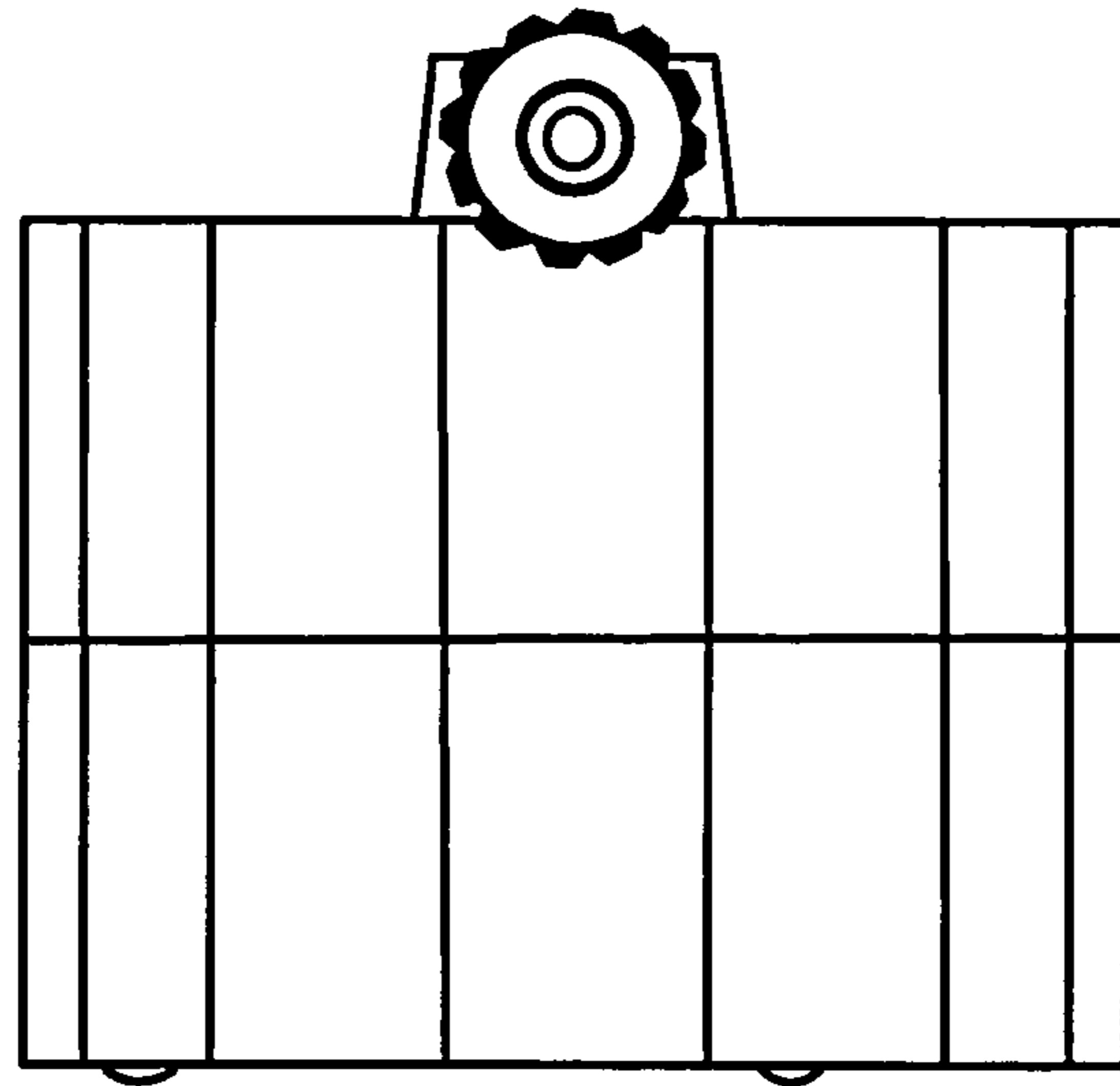

FIG. 6

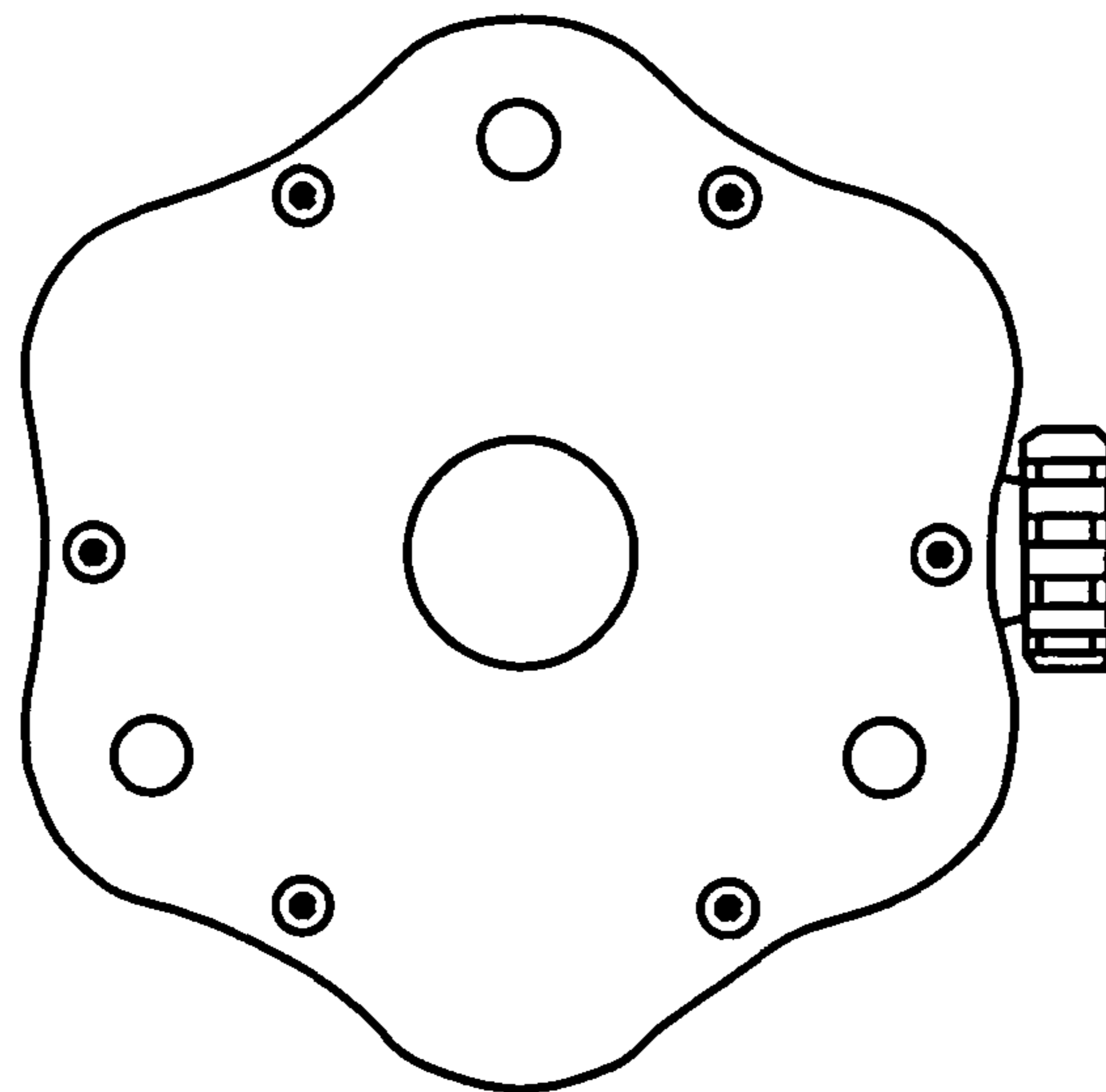

FIG. 7

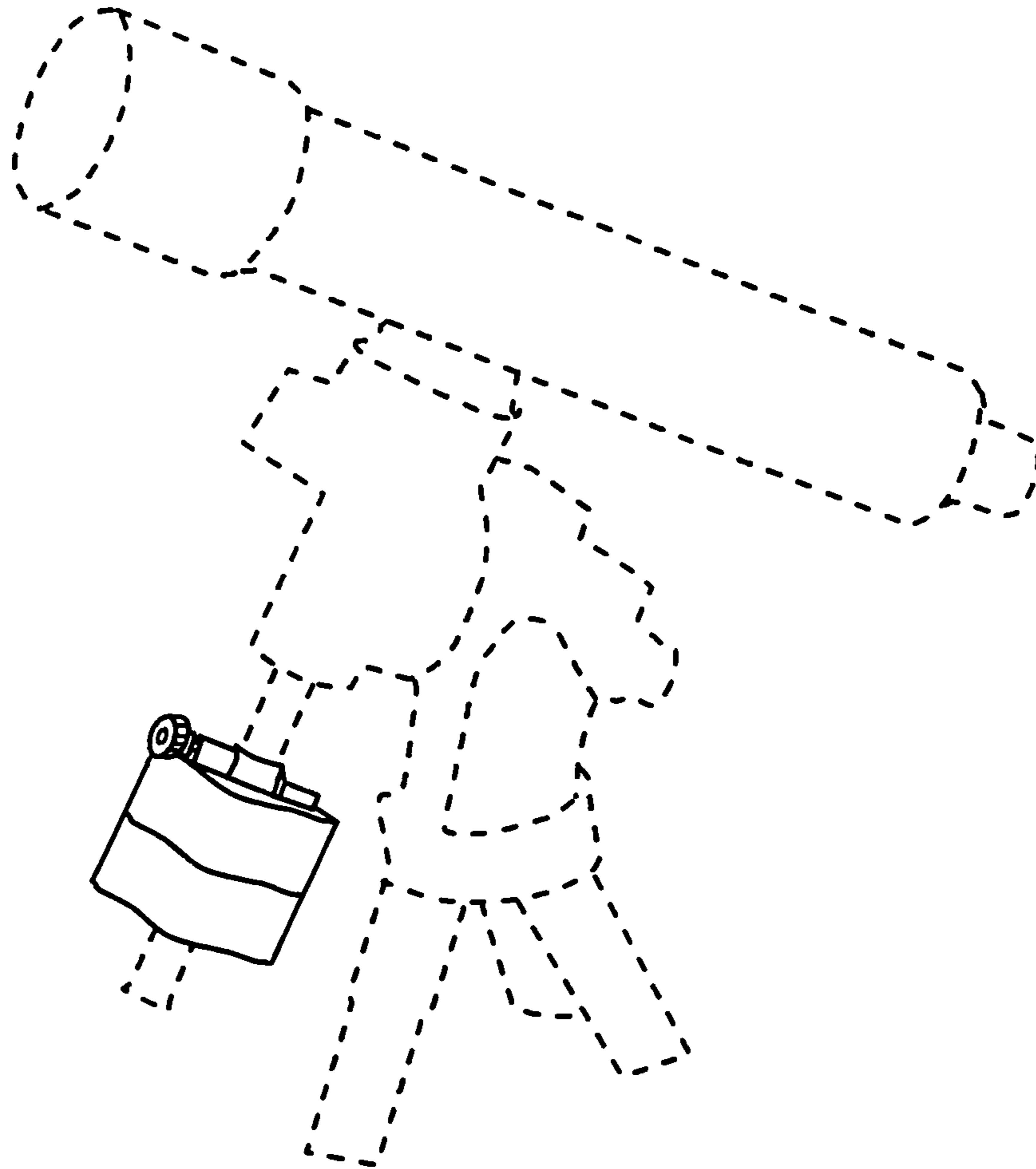

FIG. 8 (Amended)