



US00D704074S

(12) **United States Design Patent**
Tsai et al.

(10) **Patent No.:** **US D704,074 S**
(45) **Date of Patent:** **** May 6, 2014**

(54) **NOTE TAB PACKAGE SET**

(71) Applicant: **Taiwan Hopax Chems. Mfg. Co., Ltd.**,
Kaohsiung (TW)

(72) Inventors: **Chin-Chung Tsai**, Kaohsiung (TW);
Yi-Hsuen Huang, Kaohsiung (TW);
Jen-Rong Liu, Kaohsiung (TW)

(73) Assignee: **Taiwan Hopax Chems. Mfg. Co., Ltd.**,
Kaohsiung (TW)

(**) Term: **14 Years**

(21) Appl. No.: **29/462,991**

(22) Filed: **Aug. 12, 2013**

(30) **Foreign Application Priority Data**

Mar. 15, 2013 (TW) 102301896

(51) **LOC (10) Cl.** **09-03**

(52) **U.S. Cl.**
USPC **D9/722; D19/86**

(58) **Field of Classification Search**
USPC D9/414, 415, 416, 424, 715, 722, 732;
D19/35, 36, 52, 65, 75, 78, 86, 81, 90,
D19/91; D6/515, 518, 519; D20/40, 42, 43;
206/39.6, 216, 425, 461-471, 575,
206/576, 581, 738, 756, 769, 775, 776, 779

See application file for complete search history.

(56) **References Cited**

U.S. PATENT DOCUMENTS

D295,020	S	*	4/1988	Franchi	D9/722
5,602,612	A	*	2/1997	Angeli et al.	396/535
D449,780	S	*	10/2001	Corella	D9/415
D499,018	S	*	11/2004	Dato et al.	D9/722
D548,620	S	*	8/2007	Ferguson et al.	D9/732
D574,435	S	*	8/2008	Jour	D19/86
2003/0183643	A1	*	10/2003	Fagen et al.	221/26
2004/0045859	A1	*	3/2004	Favale	206/471

* cited by examiner

Primary Examiner — Derrick Holland

Assistant Examiner — Lauren Calve

(74) *Attorney, Agent, or Firm* — Bacon & Thomas, PLLC

(57) **CLAIM**

The ornamental design for a note tab package set, as shown and described.

DESCRIPTION

FIG. 1 is a perspective view of a note tab package set showing our new design;

FIG. 2 is a front view thereof;

FIG. 3 is a rear view thereof;

FIG. 4 is a left side view thereof;

FIG. 5 is a right side view thereof;

FIG. 6 is a top view thereof; and,

FIG. 7 is a bottom view thereof.

The broken lines shown in FIGS. 1-2 and 4-7 represent unclaimed subject matter and form no part of the claimed design.

The broken lines shown on the backing card of the note tab package set in FIGS. 1-3 represent perforation and form part of the claimed design.

1 Claim, 6 Drawing Sheets

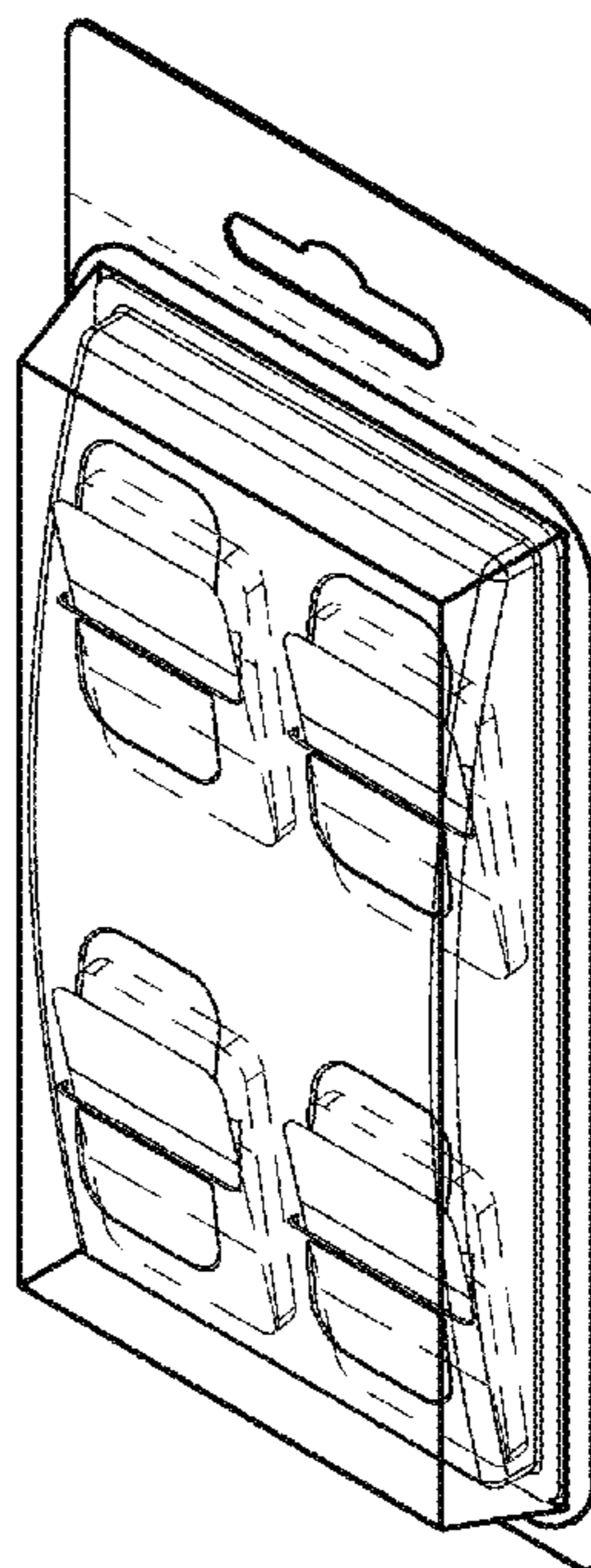

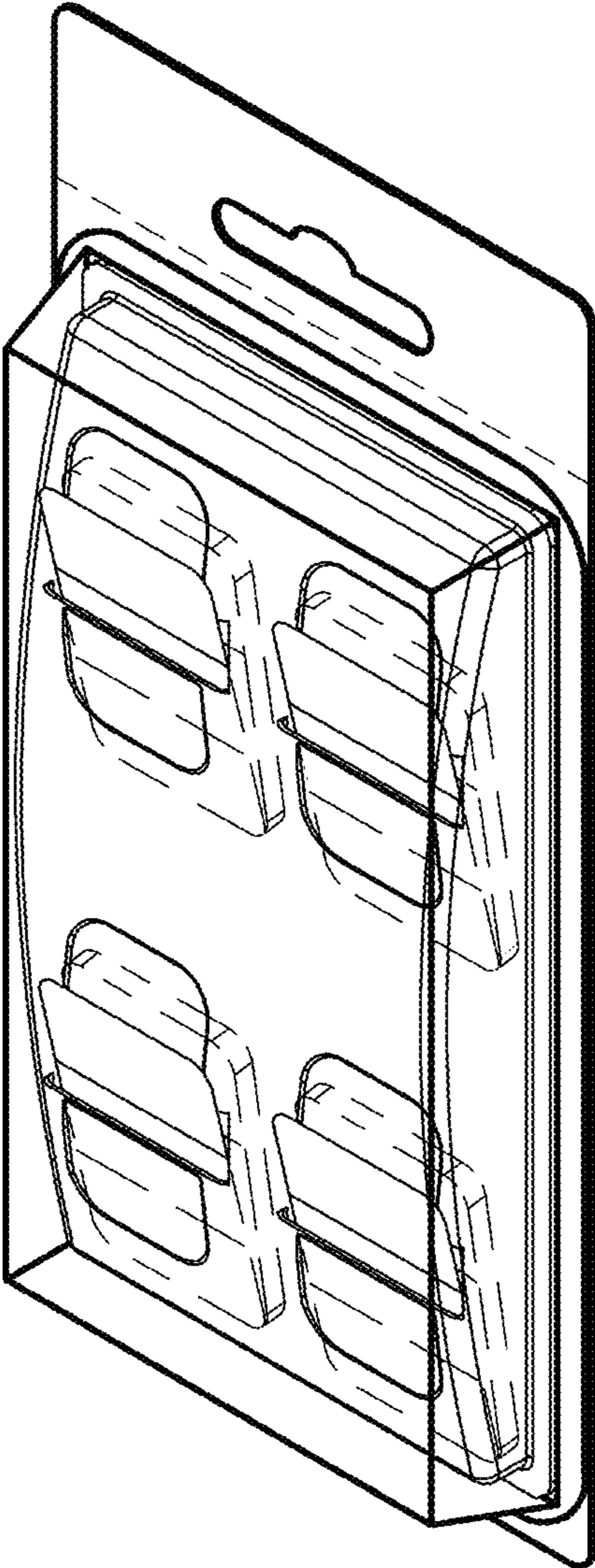

Fig.1

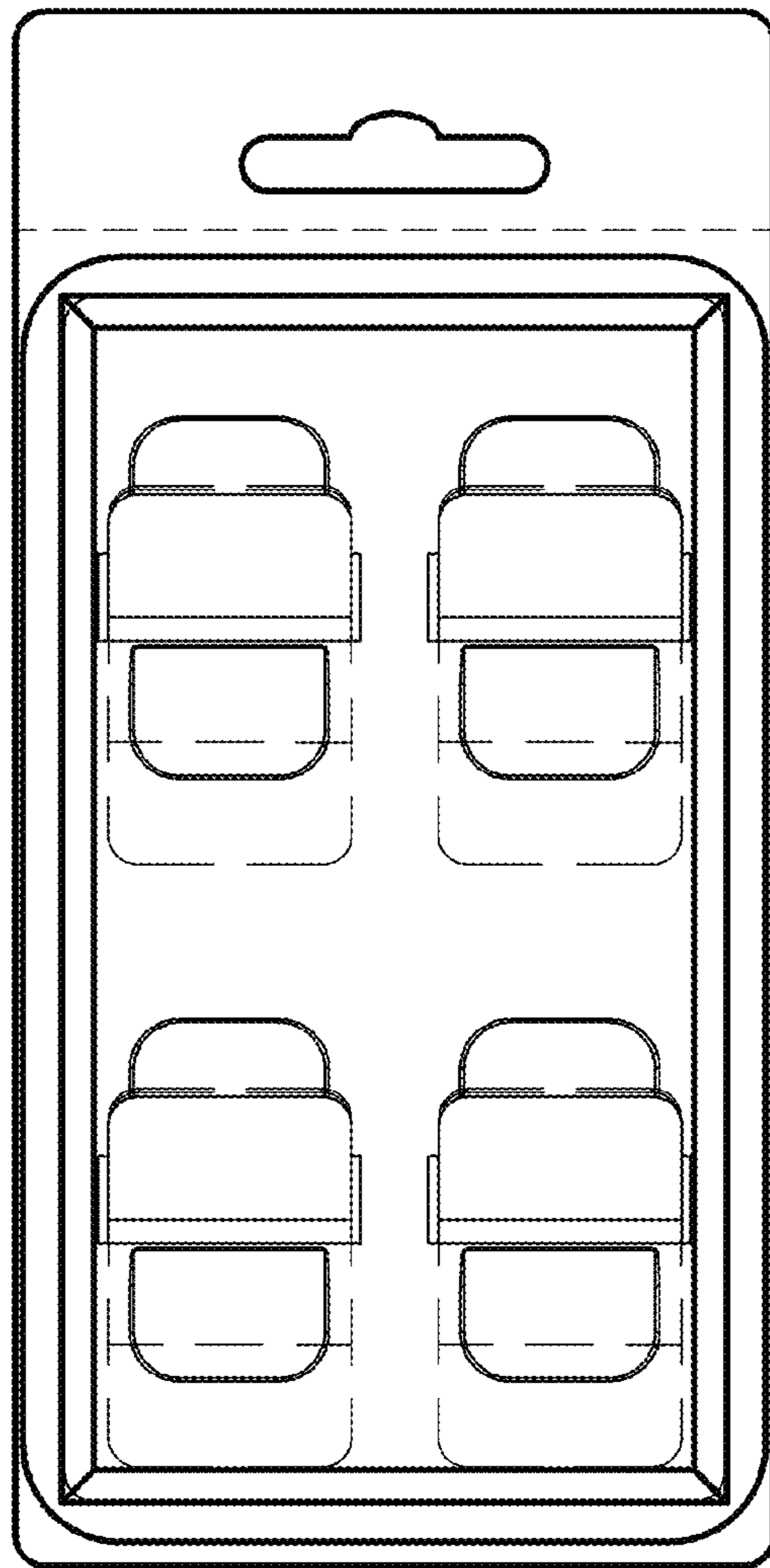

Fig.2



Fig.3

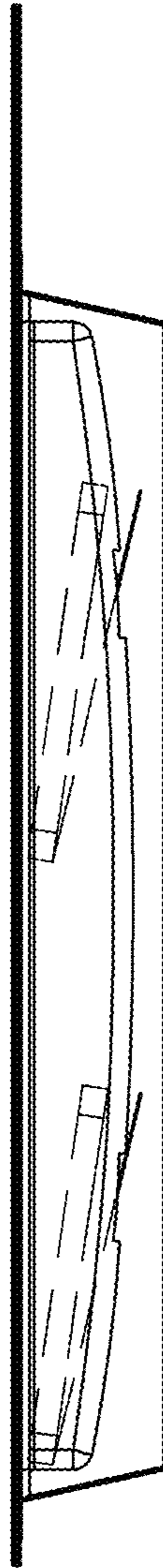

Fig.4

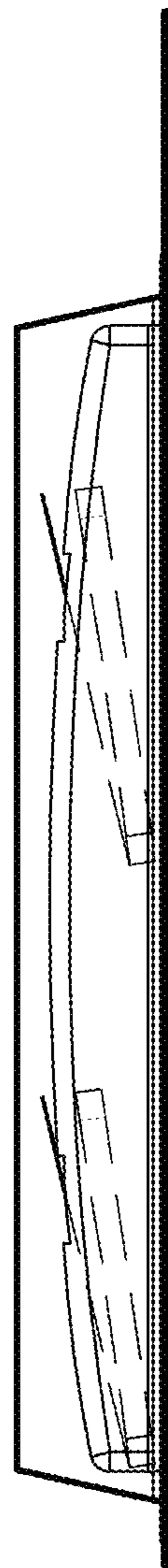

Fig.5

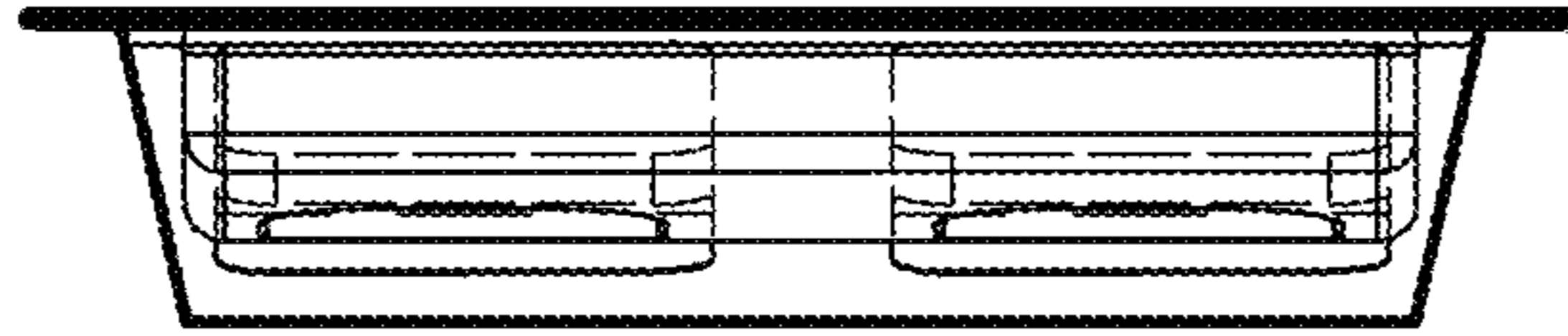

Fig.6

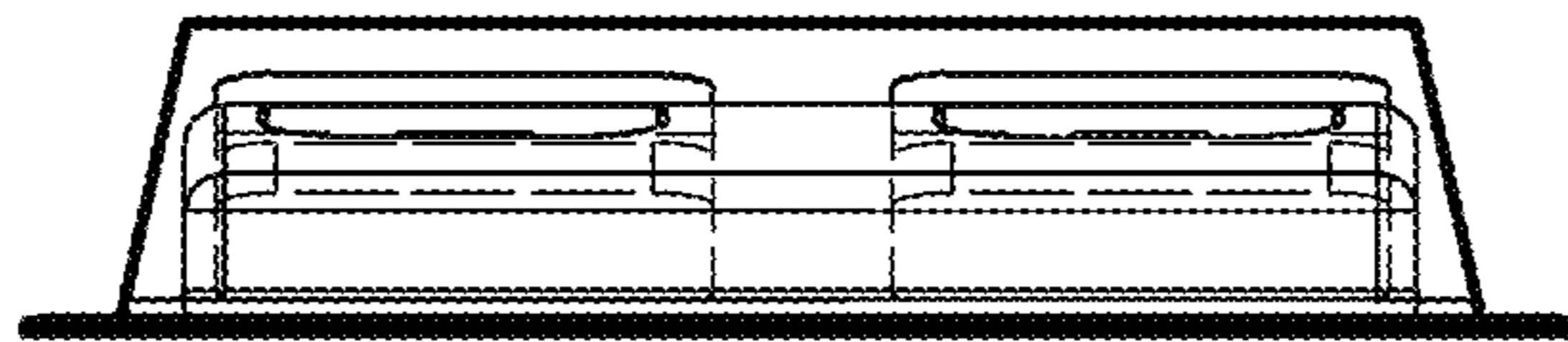

Fig.7