



US00D704010S

(12) **United States Design Patent**
Shahani

(10) **Patent No.:** **US D704,010 S**

(45) **Date of Patent:** **** May 6, 2014**

(54) **KNIFE**

(71) Applicant: **Rajoo M. Shahani**, Fairlawn, NJ (US)

(72) Inventor: **Rajoo M. Shahani**, Fairlawn, NJ (US)

(73) Assignee: **Telebrands Corp.**, Fairfield, NJ (US)

(**) Term: **14 Years**

(21) Appl. No.: **29/451,183**

(22) Filed: **Mar. 28, 2013**

(51) **LOC (10) Cl.** **07-03**

(52) **U.S. Cl.**
USPC **D7/649**

(58) **Field of Classification Search**
USPC D7/368, 393-395, 401.2, 642-646,
D7/649-654, 660-664, 669, 675-676, 683,
D7/688-692, 695-696; D8/5, 25, 83,
D8/98-99, 107, 303; D24/146-147;
30/115, 137, 141-143, 147-150,
30/322-327, 329, 335, 340, 342-348,
30/355; 416/70 R
See application file for complete search history.

(56) **References Cited**

U.S. PATENT DOCUMENTS

D177,743 S * 5/1956 Marx D7/650
D304,154 S * 10/1989 Osterhout D8/99

D403,204 S * 12/1998 Kwok D7/401.2
D439,806 S 4/2001 Juhlin et al.
D442,841 S * 5/2001 Balolia D8/99
D464,539 S * 10/2002 Richwine et al. D8/5
D525,088 S * 7/2006 Fort et al. D7/652
D545,637 S * 7/2007 Curtin D7/650
D554,949 S * 11/2007 Hood D7/650
D573,850 S * 7/2008 Curtin D7/649
D581,732 S * 12/2008 Epstein D7/401.2
D581,733 S * 12/2008 Epstein D7/401.2
D600,506 S * 9/2009 Miltner et al. D7/649
D643,256 S 8/2011 Hirai
D643,257 S * 8/2011 Hirai D7/649

* cited by examiner

Primary Examiner — Ricky Pham

(74) *Attorney, Agent, or Firm* — Jeffrey L. Snow; Cooper & Dunham, LLP

(57) **CLAIM**

The ornamental design for a knife, as shown and described.

DESCRIPTION

FIG. 1 is a bottom perspective view thereof;
FIG. 2 is a front view thereof;
FIG. 3 is a rear view thereof;
FIG. 4 is a right side view thereof;
FIG. 5 is a left side view thereof;
FIG. 6 is a top side view thereof; and,
FIG. 7 is a bottom side view thereof.

1 Claim, 6 Drawing Sheets

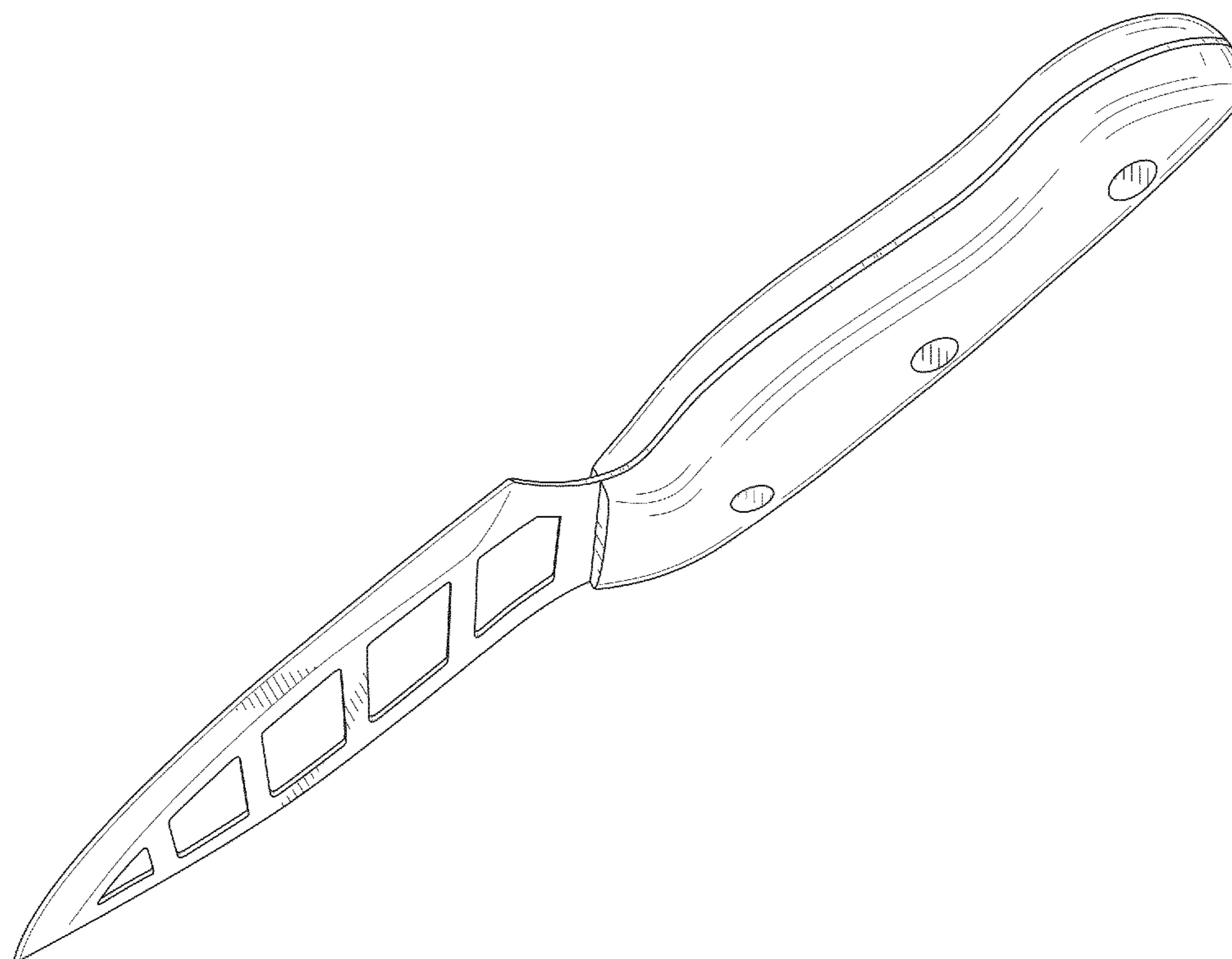

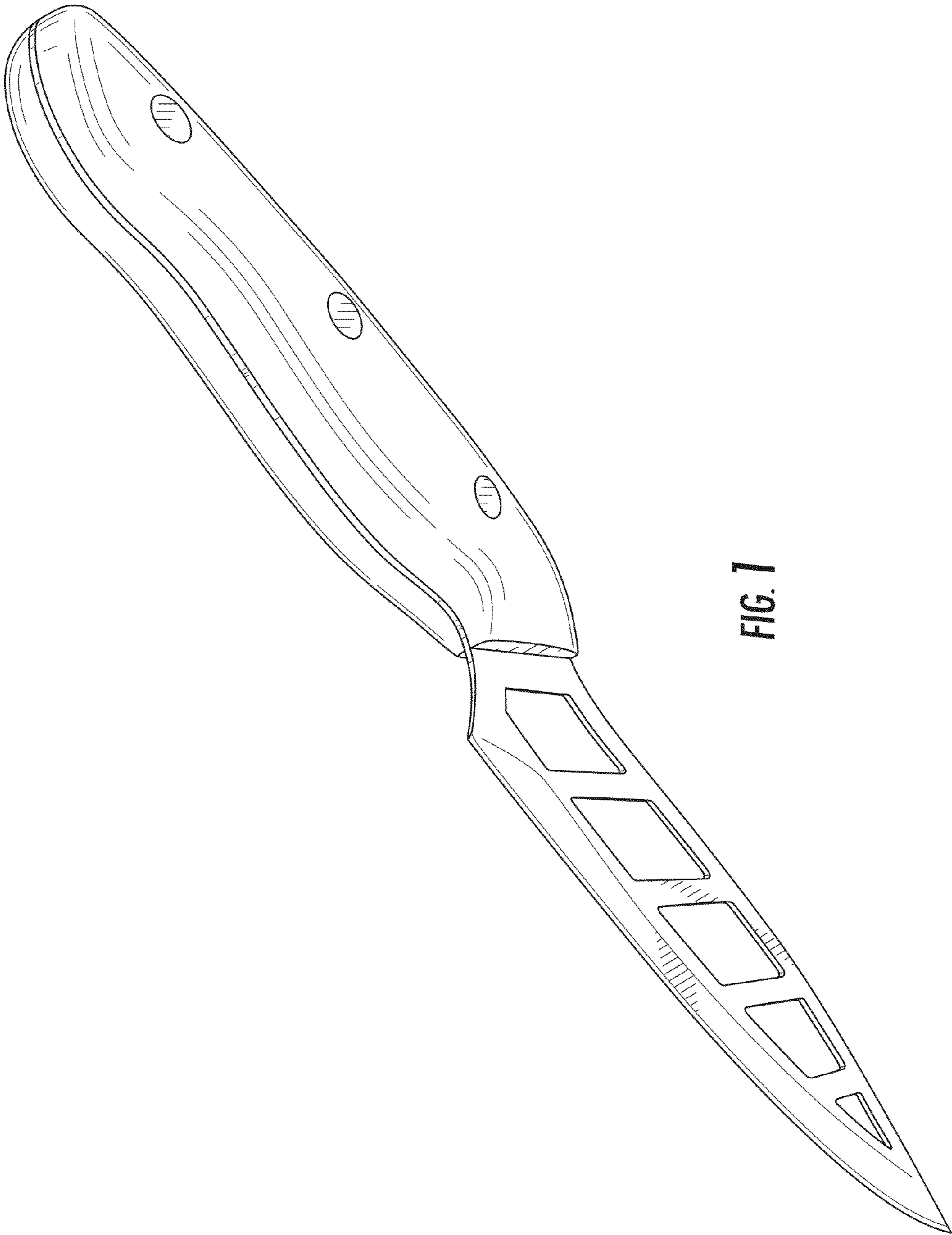

FIG. 1

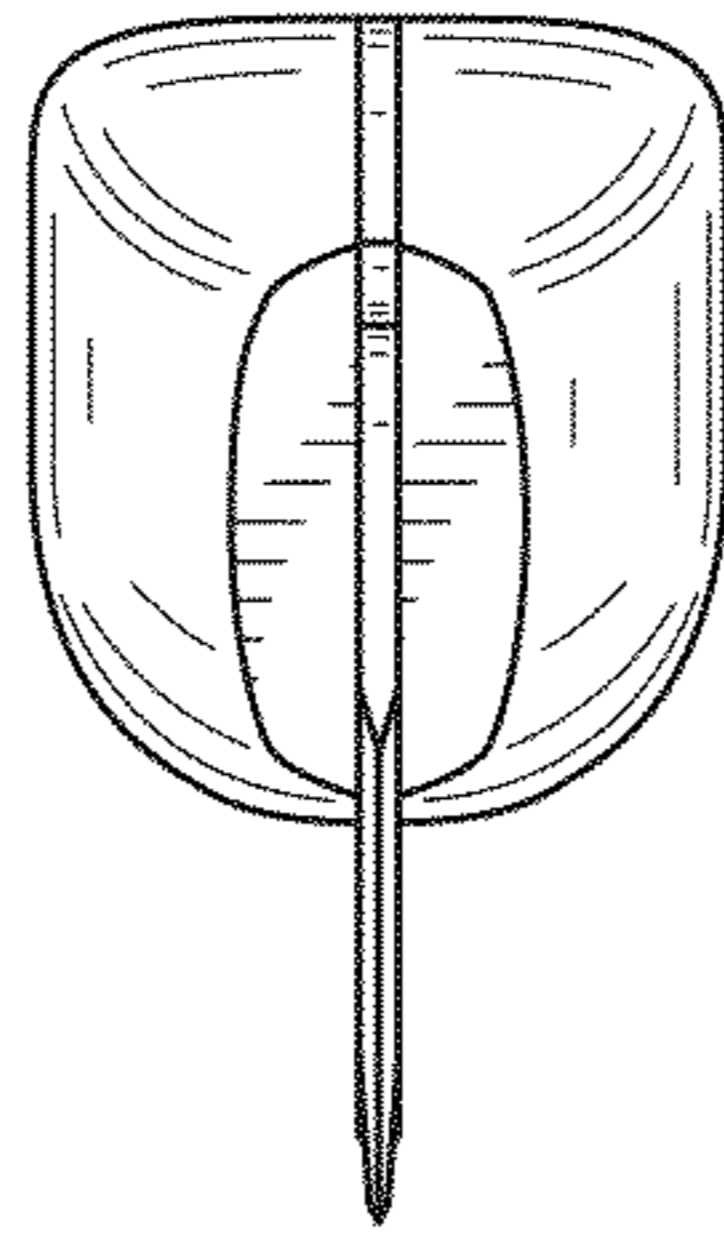

FIG. 2

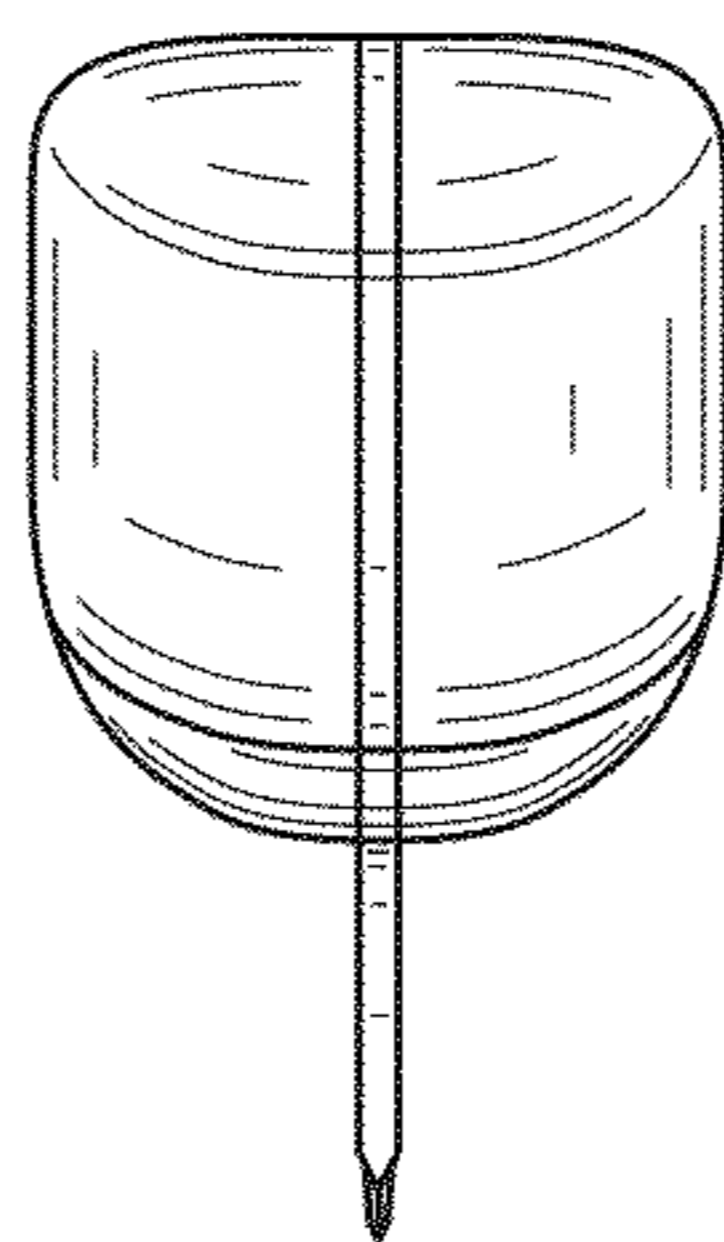

FIG. 3

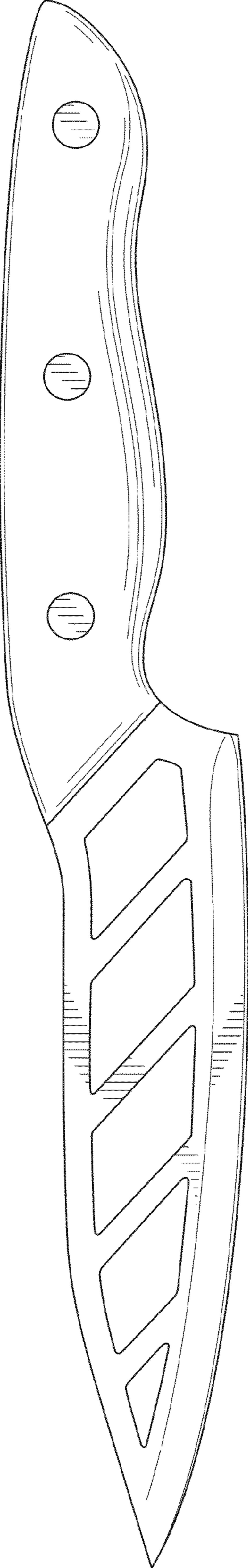

FIG. 4

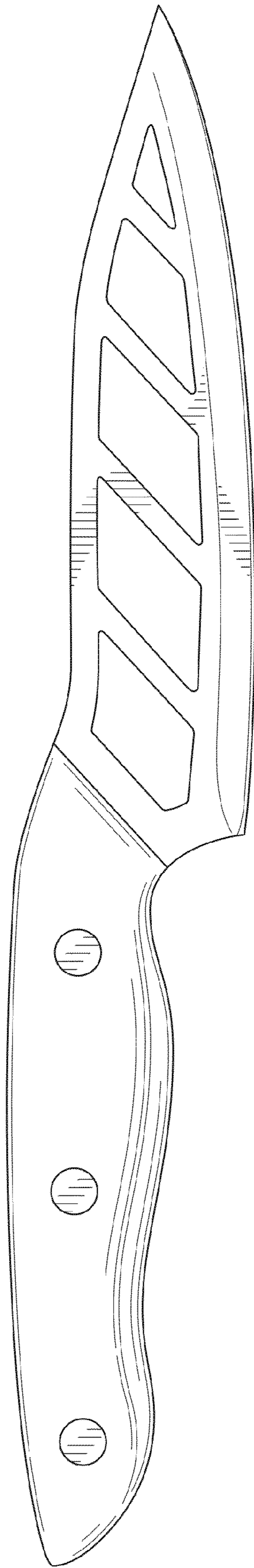

FIG. 5

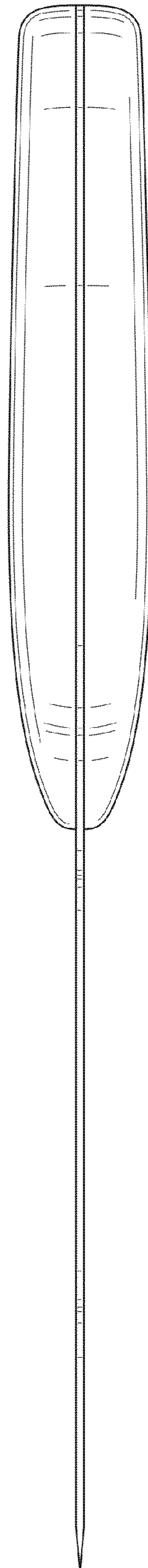

FIG. 6

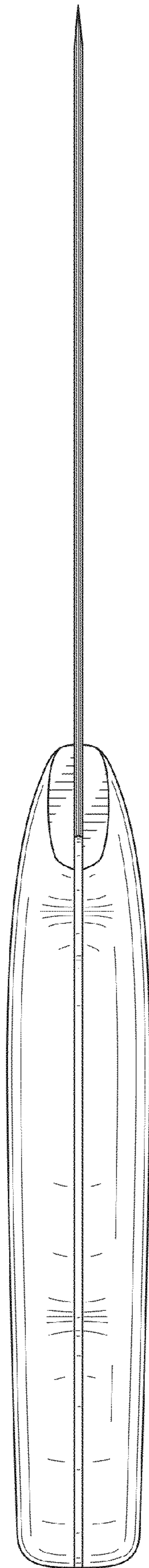

FIG. 7