



US00D704001S

(12) **United States Design Patent**
Lane

(10) **Patent No.:** **US D704,001 S**

(45) **Date of Patent:** **** May 6, 2014**

(54) **DRINK BOTTLE WITH SMOOTH HAND GRIP**

(75) Inventor: **Marvin Lane**, Round Lake Beach, IL (US)

(73) Assignee: **Thermos L.L.C.**, Schaumburg, IL (US)

(**) Term: **14 Years**

(21) Appl. No.: **29/422,413**

(22) Filed: **May 21, 2012**

(51) **LOC (10) Cl.** **07-01**

(52) **U.S. Cl.**
USPC **D7/509**; D7/533; D9/530

(58) **Field of Classification Search**
USPC D7/300.1, 510, 511, 509, 523, 608,
D7/533; D9/523, 445, 530; 220/715, 568,
220/212.5, 713, 718; 222/570, 547
See application file for complete search history.

(56) **References Cited**

U.S. PATENT DOCUMENTS

3,757,979	A	9/1973	Berghahn	
3,944,101	A	3/1976	Landen et al.	
D436,862	S	1/2001	Witt et al.	
D450,982	S *	11/2001	Gaze et al.	D7/608
D451,392	S	12/2001	Kitamura et al.	
D463,280	S	9/2002	Brozell	
6,484,895	B2	11/2002	Montgomery et al.	
D479,949	S *	9/2003	Janky	D7/511
D514,446	S	2/2006	Choi	
D524,650	S	7/2006	Sitomer	
D529,761	S *	10/2006	Trombly	D7/509
D546,122	S *	7/2007	Gluck	D7/509
D571,147	S	6/2008	Rohe	
D575,103	S *	8/2008	Gluck	D7/396.2
D581,216	S *	11/2008	Williams	D7/510
D589,743	S	4/2009	Pearson	
D589,750	S *	4/2009	Liu et al.	D7/510

D607,698	S *	1/2010	Tsukida	D7/608
D608,640	S *	1/2010	Carreno	D9/449
D609,093	S	2/2010	Wisniewski et al.	
D610,454	S	2/2010	Lohrman et al.	
D623,896	S	9/2010	Wahl et al.	

(Continued)

OTHER PUBLICATIONS

Contigo—Autospout Addison Water Bottle—24 oz., printed Jun. 20, 2012.

(Continued)

Primary Examiner — Marianne Pandozzi

(74) Attorney, Agent, or Firm — Polsinelli PC

(57) **CLAIM**

The ornamental design of the drink bottle with smooth hand grip, as shown and described.

DESCRIPTION

FIG. 1 is a perspective view taken from the upper, front, right-hand side of the drink bottle with smooth hand grip of the present invention;

FIG. 2 is a perspective view taken from the lower, rear, left-hand side of the drink bottle with smooth hand grip of FIG. 1; FIG. 3 is a side elevational view of the left side of the drink bottle with smooth hand grip of FIG. 1;

FIG. 4 is a front elevational view of the drink bottle with smooth hand grip of FIG. 1;

FIG. 5 is a side elevational view of the right side of the drink bottle with smooth hand grip of FIG. 1;

FIG. 6 is a rear elevational view of the drink bottle with smooth hand grip of FIG. 1;

FIG. 7 is an enlarged top plan view of the drink bottle with smooth hand grip of FIG. 1; and,

FIG. 8 is an enlarged bottom plan view of the drink bottle with smooth hand grip of FIG. 1.

1 Claim, 5 Drawing Sheets

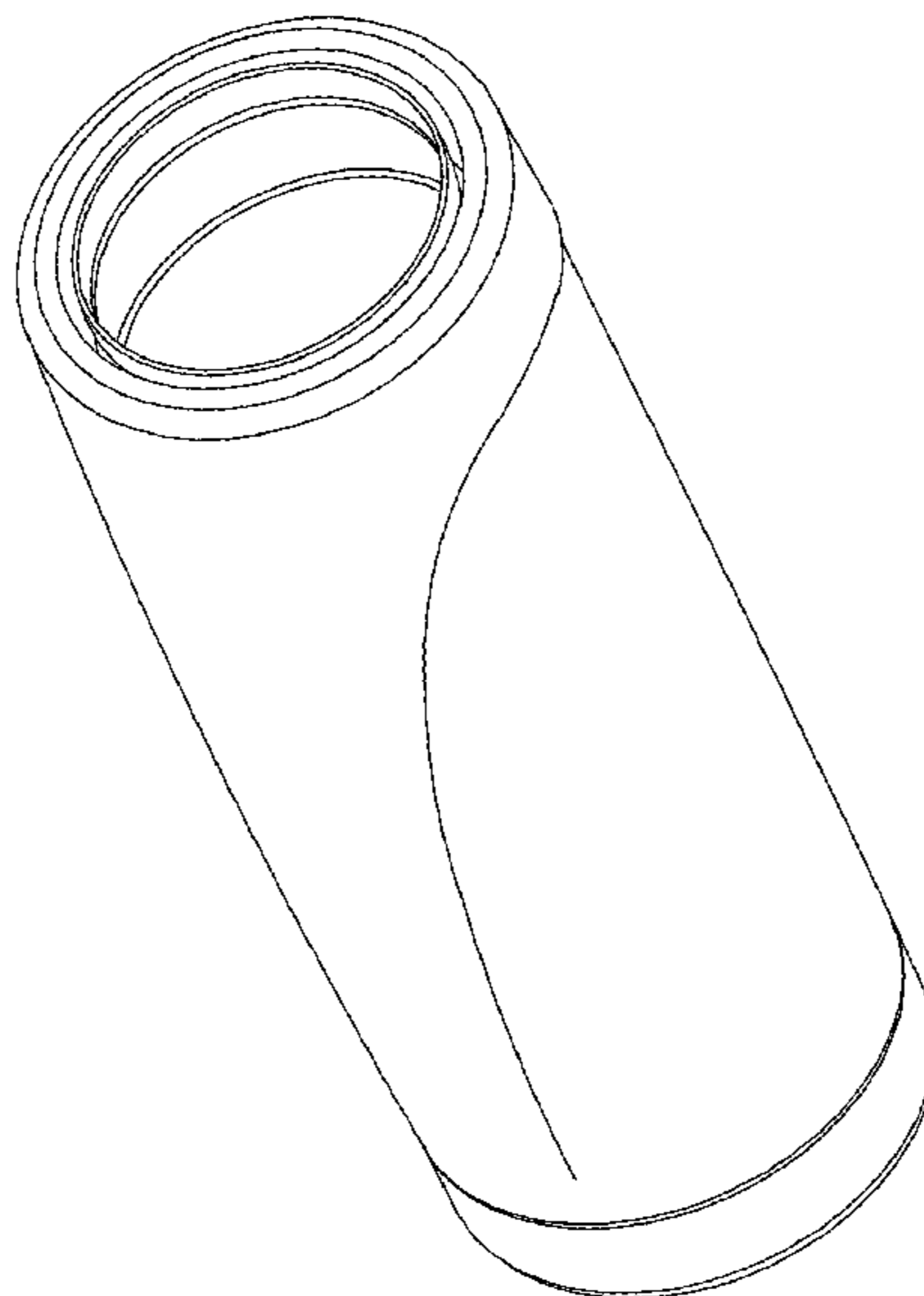

(56)

References Cited

U.S. PATENT DOCUMENTS

D630,093 S 1/2011 Bardet
D634,628 S 3/2011 Goto et al.
D636,672 S 4/2011 Lohrman et al.
D648,984 S * 11/2011 Gullickson et al. D7/510
D650,687 S * 12/2011 Schrinier et al. D9/530
D653,493 S * 2/2012 Enghard D7/300.1
D656,360 S 3/2012 Miller et al.
D666,047 S * 8/2012 Lin D7/300.1
D687,262 S * 8/2013 Bucceri D7/510

D687,661 S * 8/2013 Cetera et al. D7/300.1
D695,069 S * 12/2013 Lane D7/510
2005/0133475 A1 6/2005 Goto et al.
2006/0043052 A1 3/2006 Lin

OTHER PUBLICATIONS

Zojirushi product—Stainless Steel Vacuum Bottle Model No. ST-
KA12, printed Jul. 26, 2011.
Co-pending U.S. Appl. No. 13/155,512, filed Jun. 8, 2011.

* cited by examiner

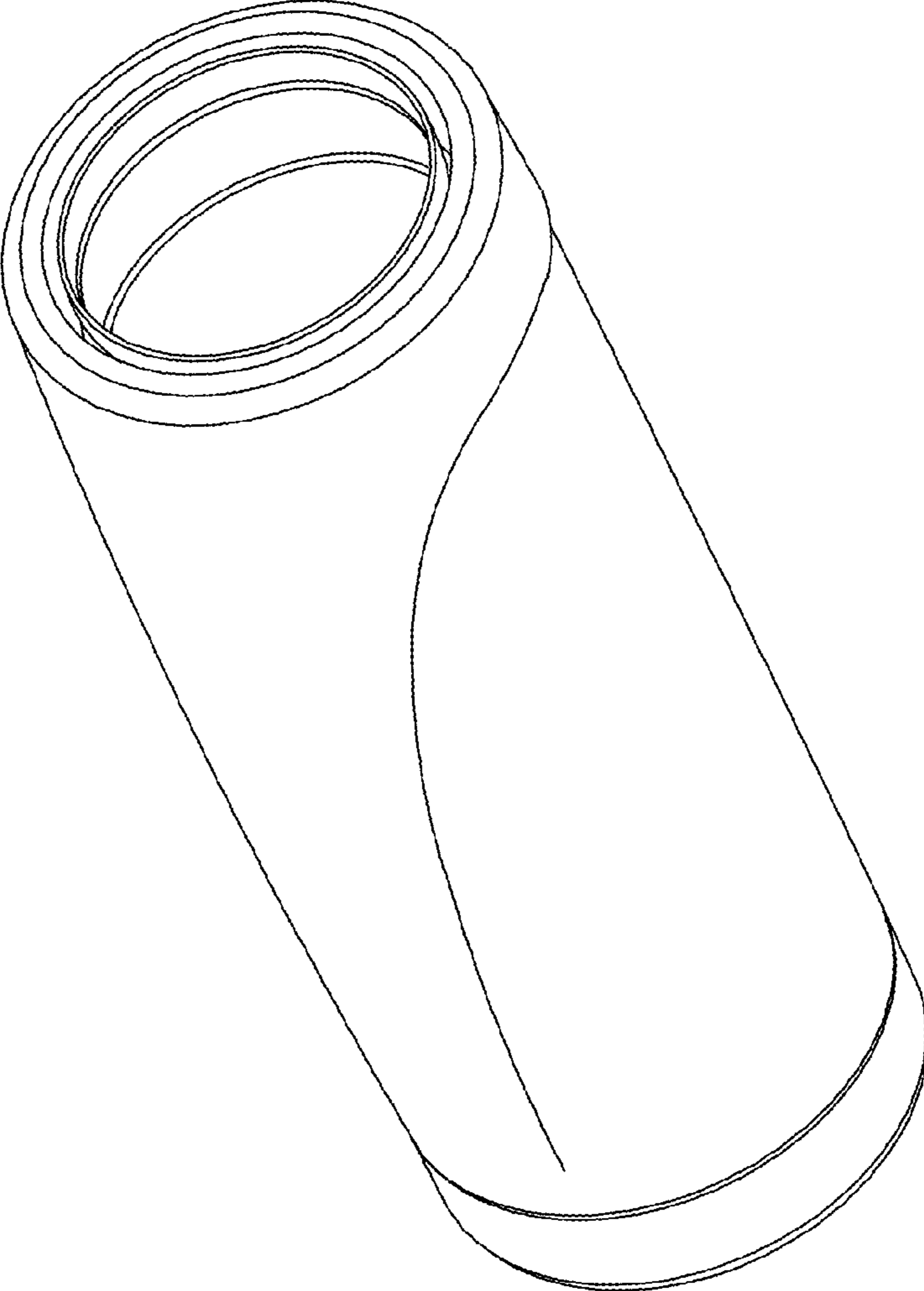

FIG. 1

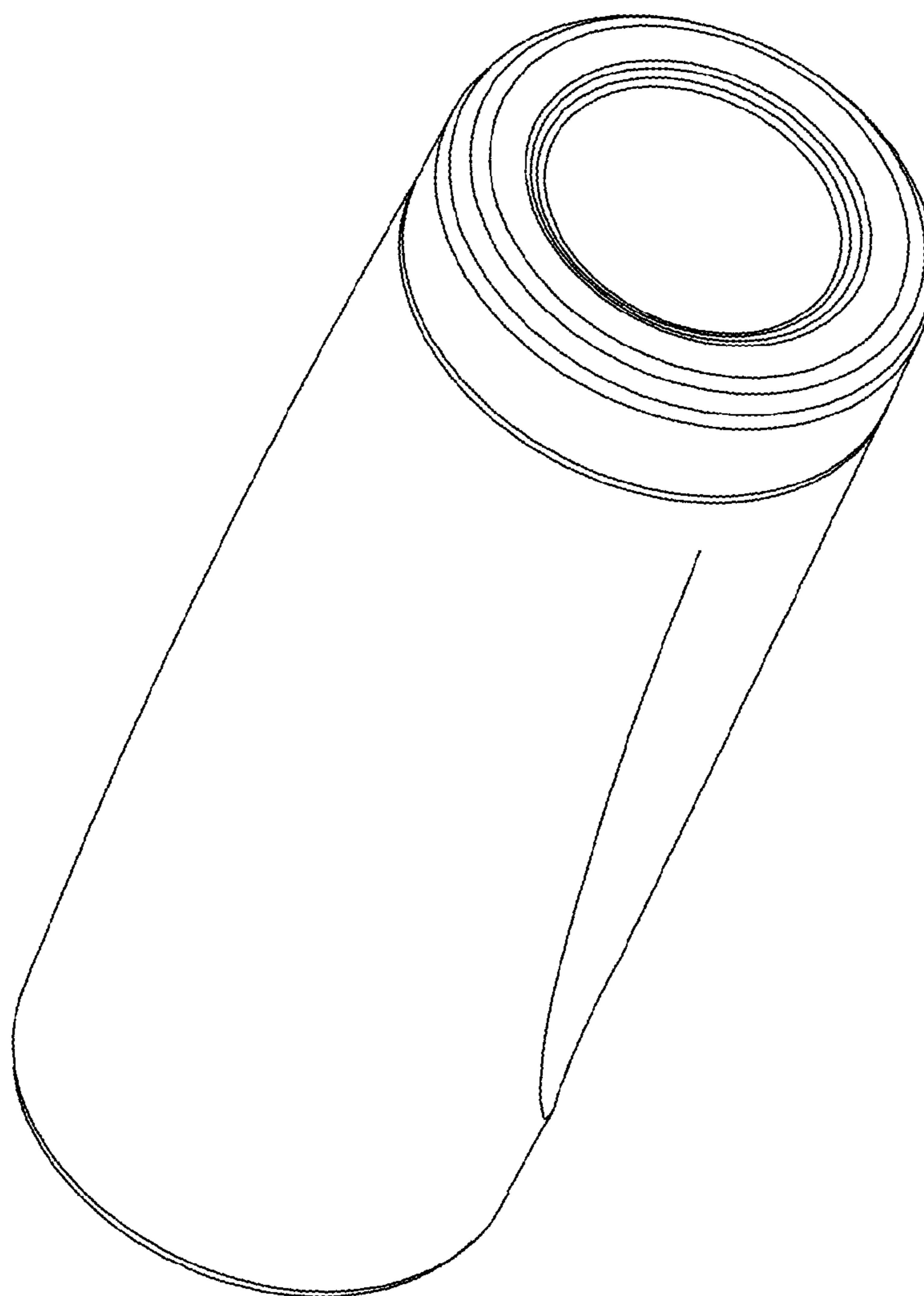

FIG. 2



FIG. 3

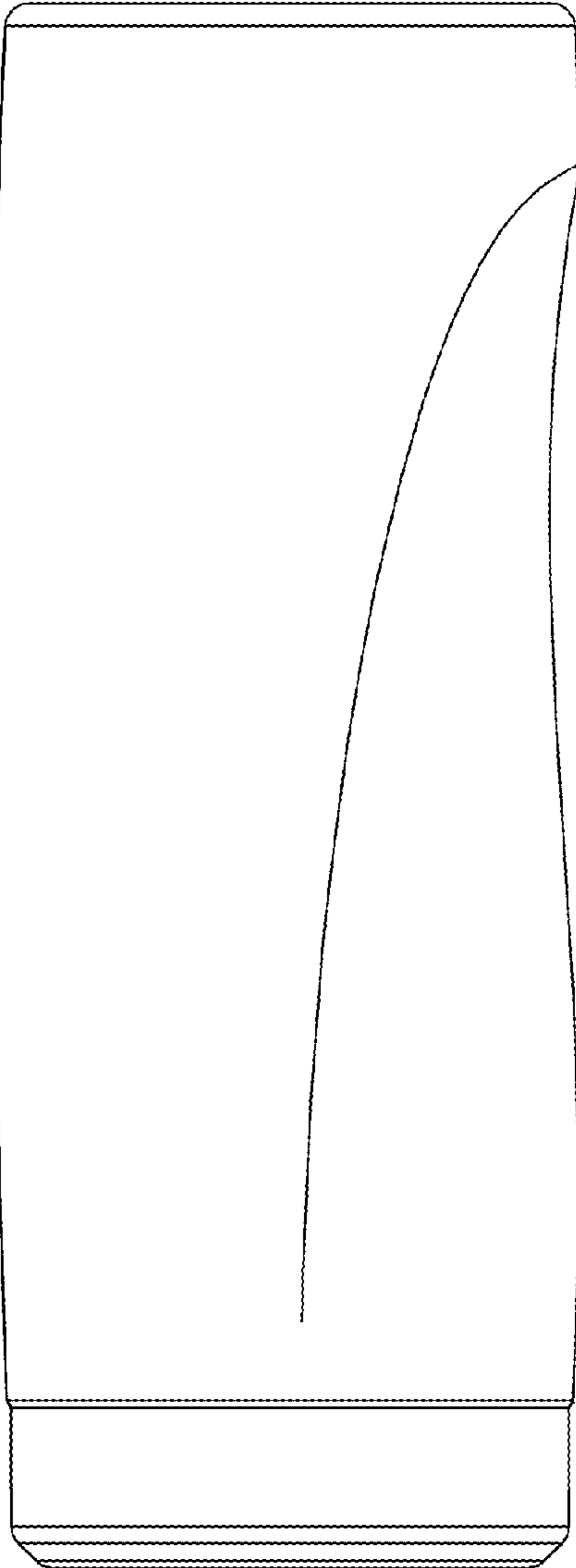

FIG. 4

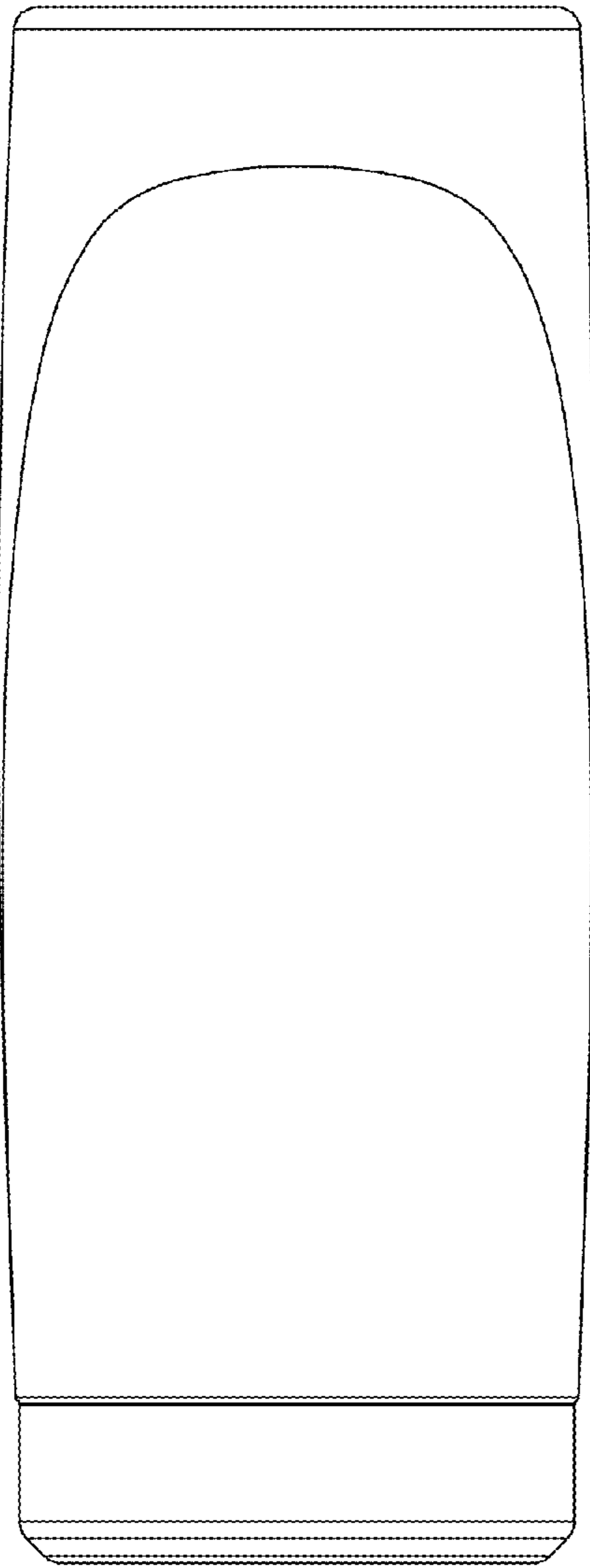

FIG. 5

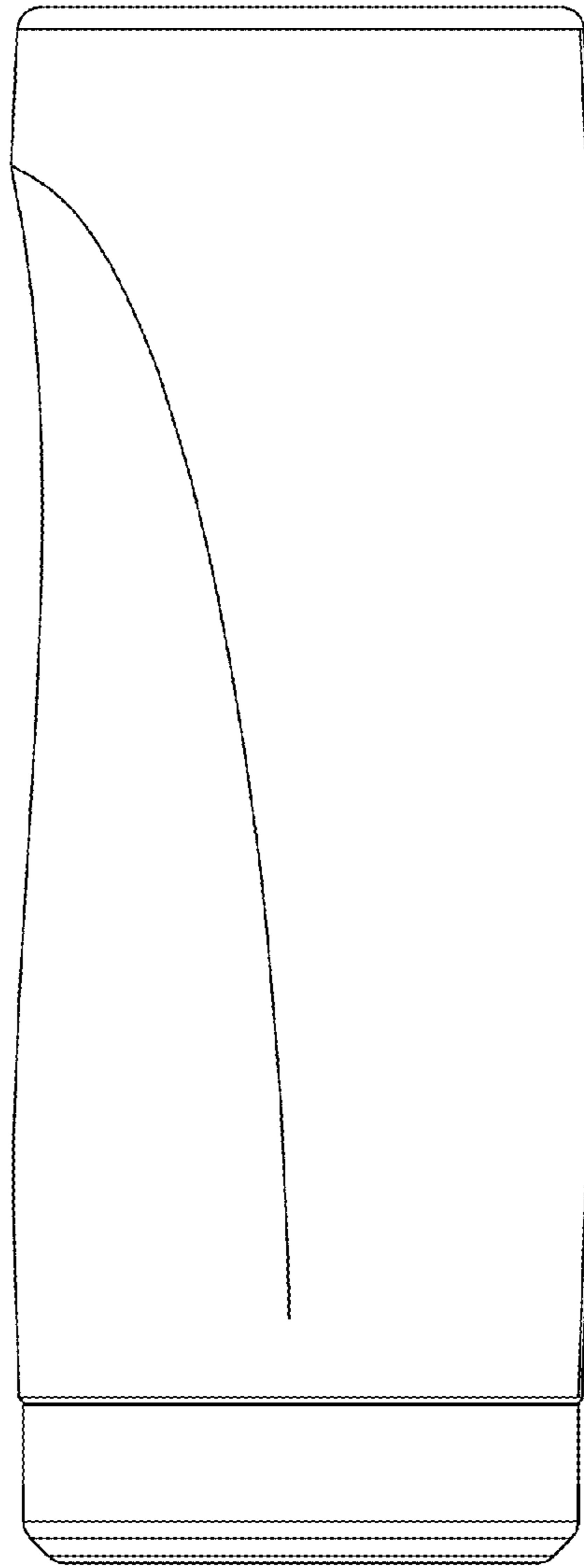

FIG. 6

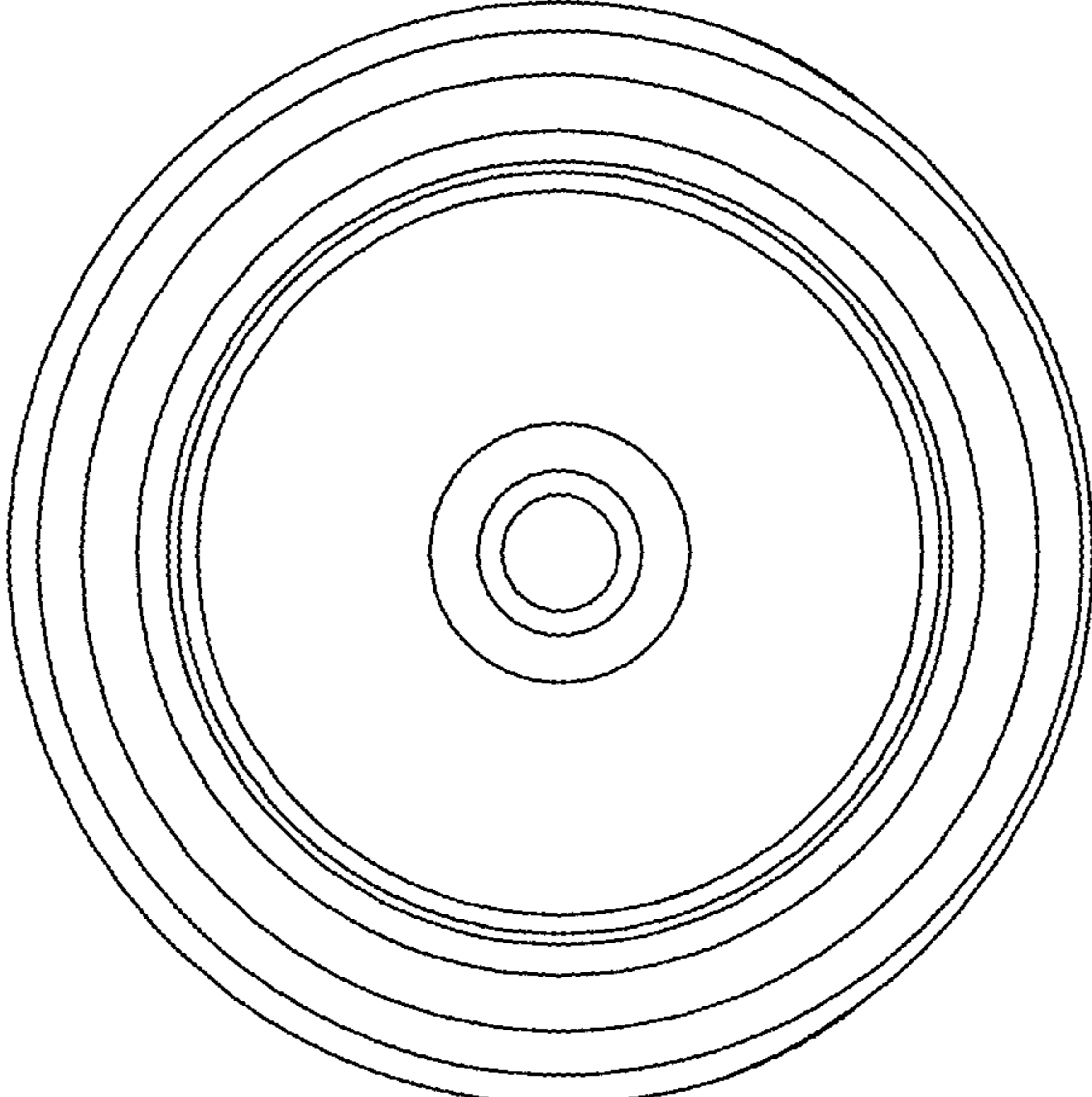

FIG. 7

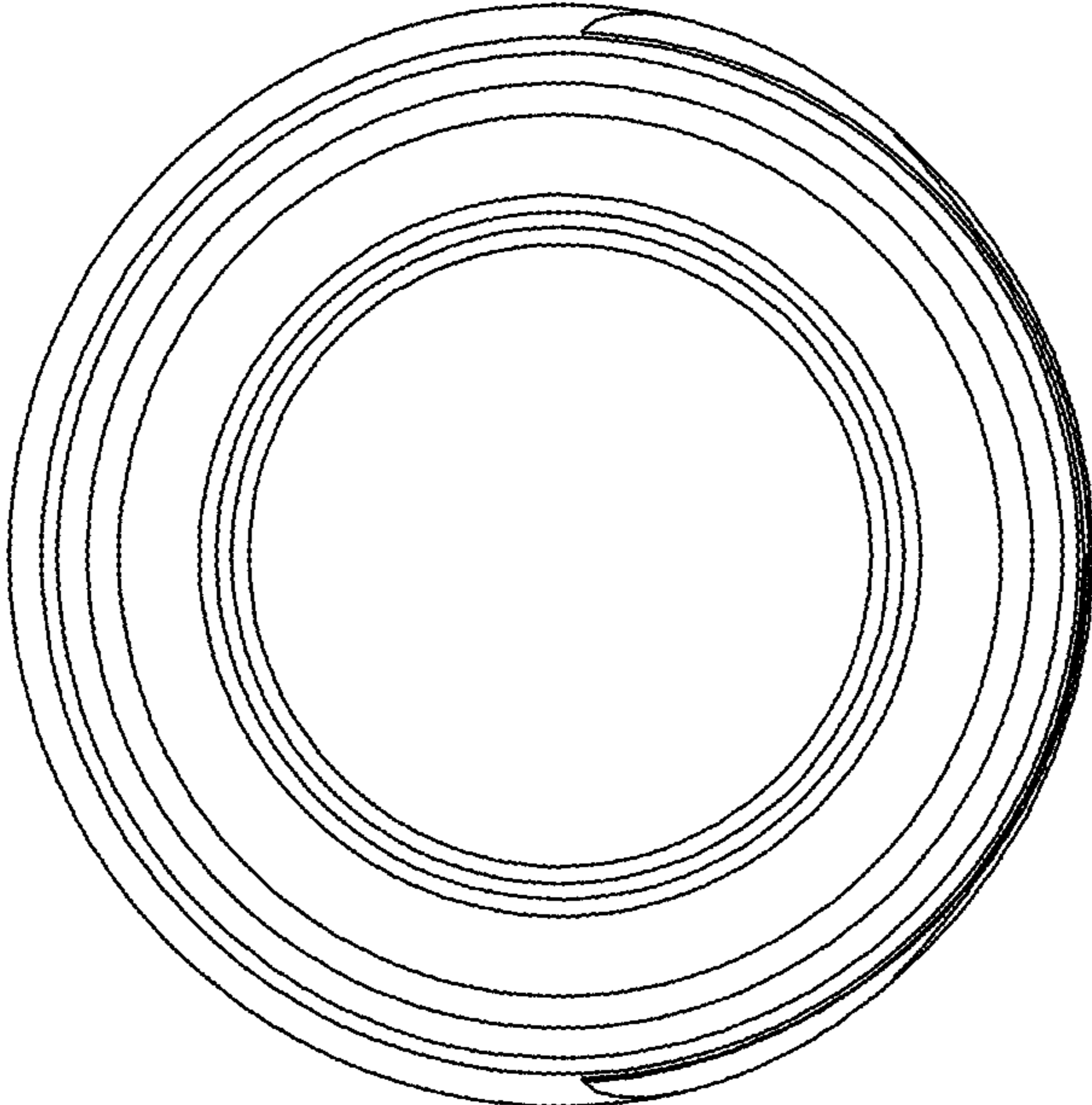

FIG. 8