



US00D703619S

(12) **United States Design Patent**
Wilkins, III

(10) **Patent No.:** **US D703,619 S**
(45) **Date of Patent:** **** Apr. 29, 2014**

(54) **TEMPORARY PROTECTIVE COVER FOR AN EXPOSED JUNCTION BOX**

(71) Applicant: **James F. Wilkins, III**, Cheltenham, PA (US)

(72) Inventor: **James F. Wilkins, III**, Cheltenham, PA (US)

(**) Term: **14 Years**

(21) Appl. No.: **29/455,285**

(22) Filed: **May 19, 2013**

(51) **LOC (10) Cl.** **13-03**

(52) **U.S. Cl.**
USPC **D13/156**

(58) **Field of Classification Search**
USPC D13/152, 154, 156, 184, 199; D8/349, D8/353; 174/50, 50.52, 50.53, 53-60, 174/66-67, 521; 439/135-138, 142, 367, 439/373, 535-537, 541, 892, 938
See application file for complete search history.

(56) **References Cited**

U.S. PATENT DOCUMENTS

D199,397 S * 10/1964 Foster et al. D14/256
D265,967 S * 8/1982 Newman D8/350
4,835,343 A * 5/1989 Graef et al. 174/66

5,166,478 A * 11/1992 Sprouse 174/138 F
D342,235 S * 12/1993 Shotey D13/156
D346,361 S * 4/1994 Richey et al. D13/156
D390,193 S * 2/1998 Ronchetti D13/156
D448,732 S * 10/2001 Kinsey et al. D13/152
D573,104 S * 7/2008 Richey D13/156
D597,035 S * 7/2009 Libby D13/156
D632,257 S * 2/2011 Higuchi D13/152
7,935,889 B1 * 5/2011 Cleghorn 174/66
D657,748 S * 4/2012 Hargreaves et al. D13/156

* cited by examiner

Primary Examiner — Derrick Holland

(74) *Attorney, Agent, or Firm* — LaMorte & Associates P.C.

(57) **CLAIM**

The ornamental design for a temporary protective cover for an exposed junction box, as shown and described.

DESCRIPTION

FIG. 1 is a top perspective view of a temporary protective cover for an exposed junction box;
FIG. 2 is a bottom perspective view thereof;
FIG. 3 is a top view thereof;
FIG. 4 is a bottom view thereof;
FIG. 5 is a front view thereof;
FIG. 6 is a rear view thereof;
FIG. 7 is a left side view thereof; and,
FIG. 8 is a right side view thereof.

1 Claim, 6 Drawing Sheets

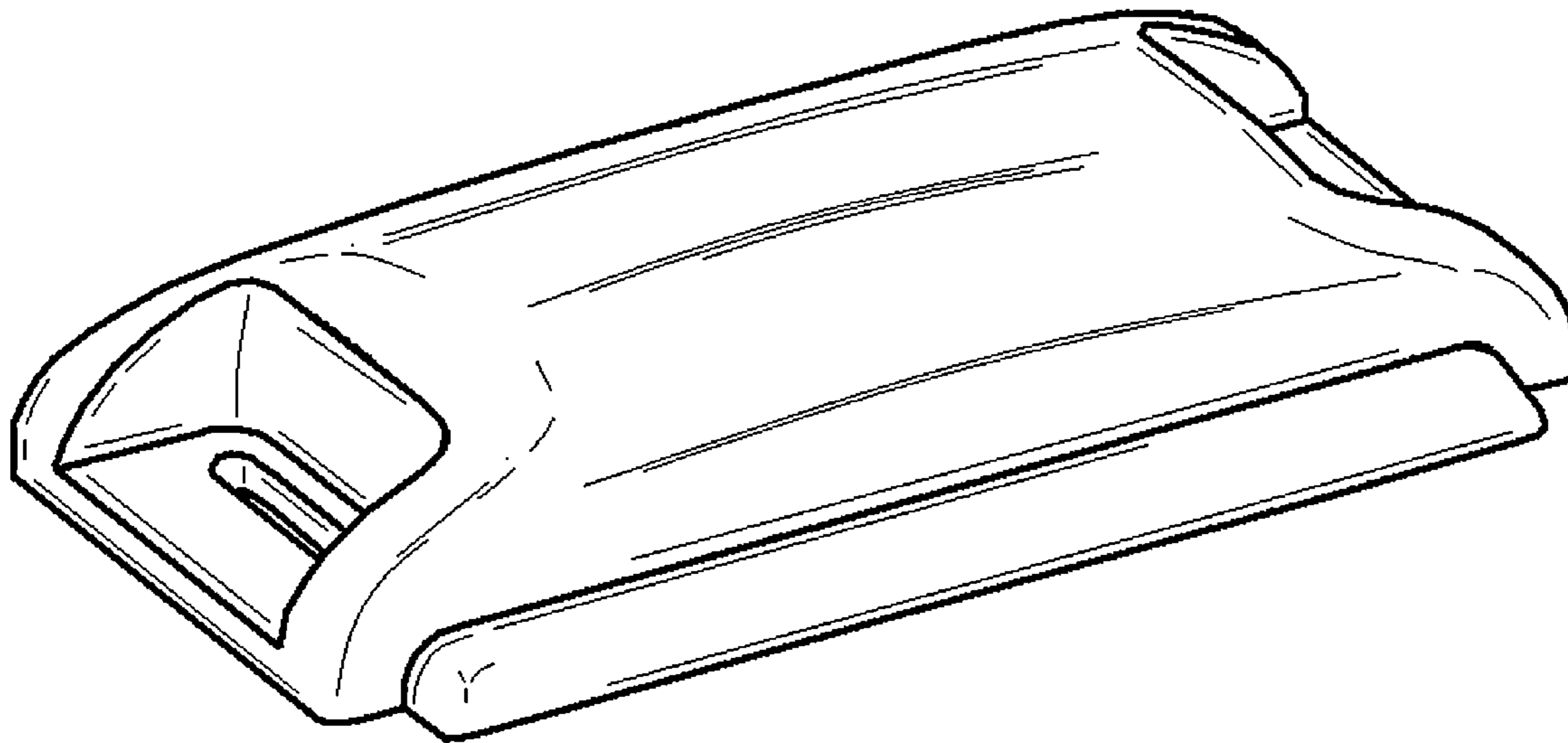

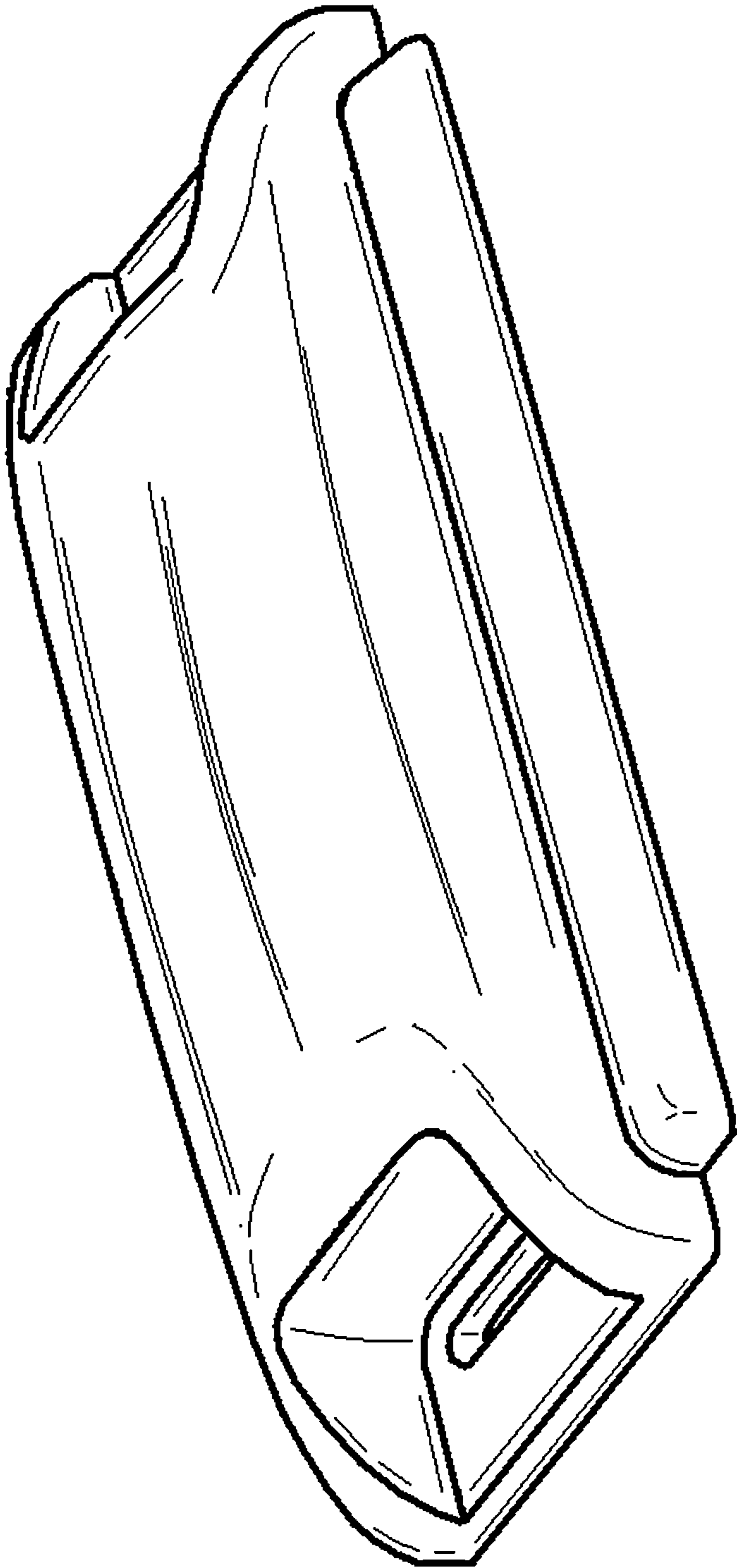

FIG. 1

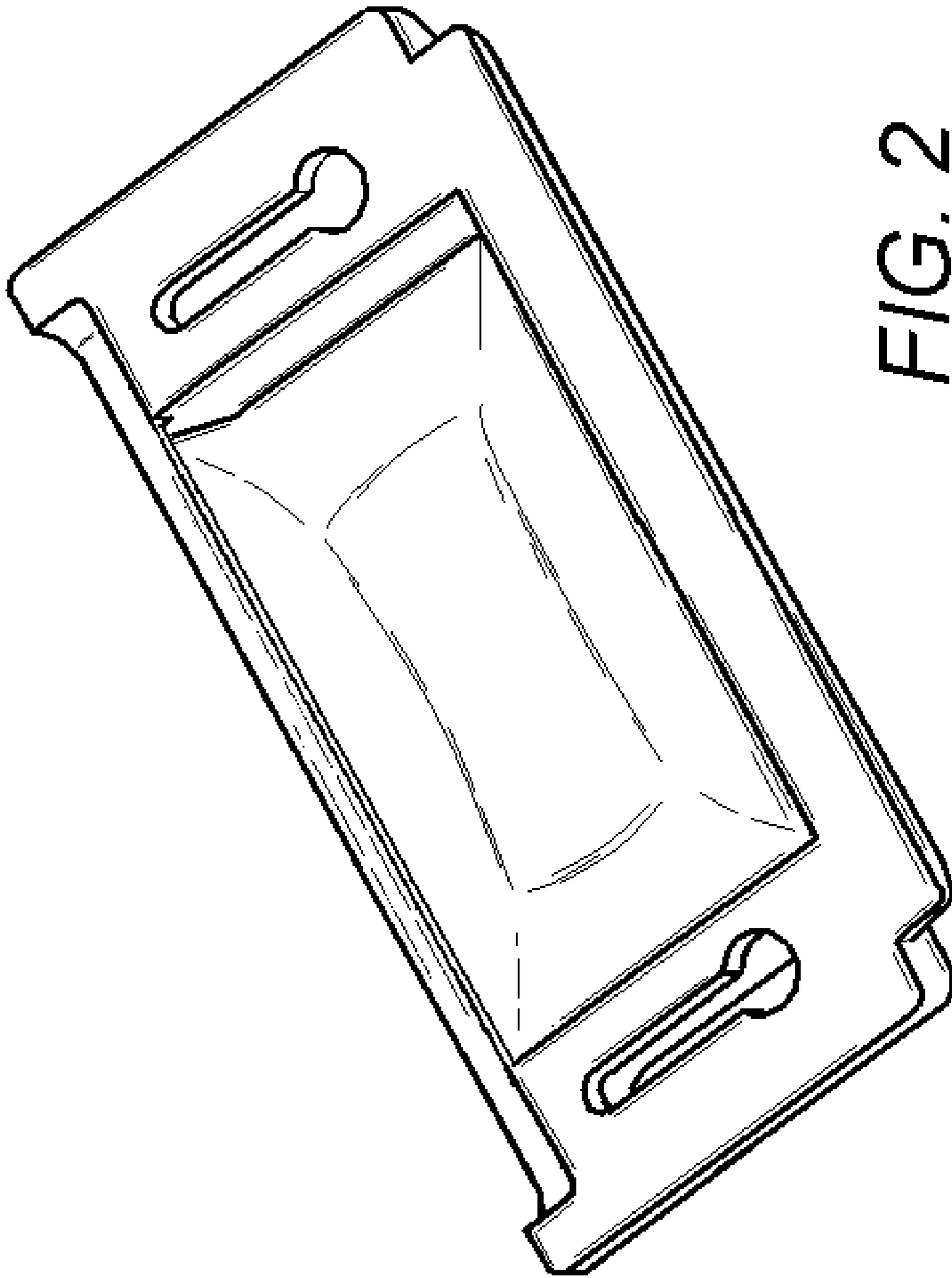

FIG. 2

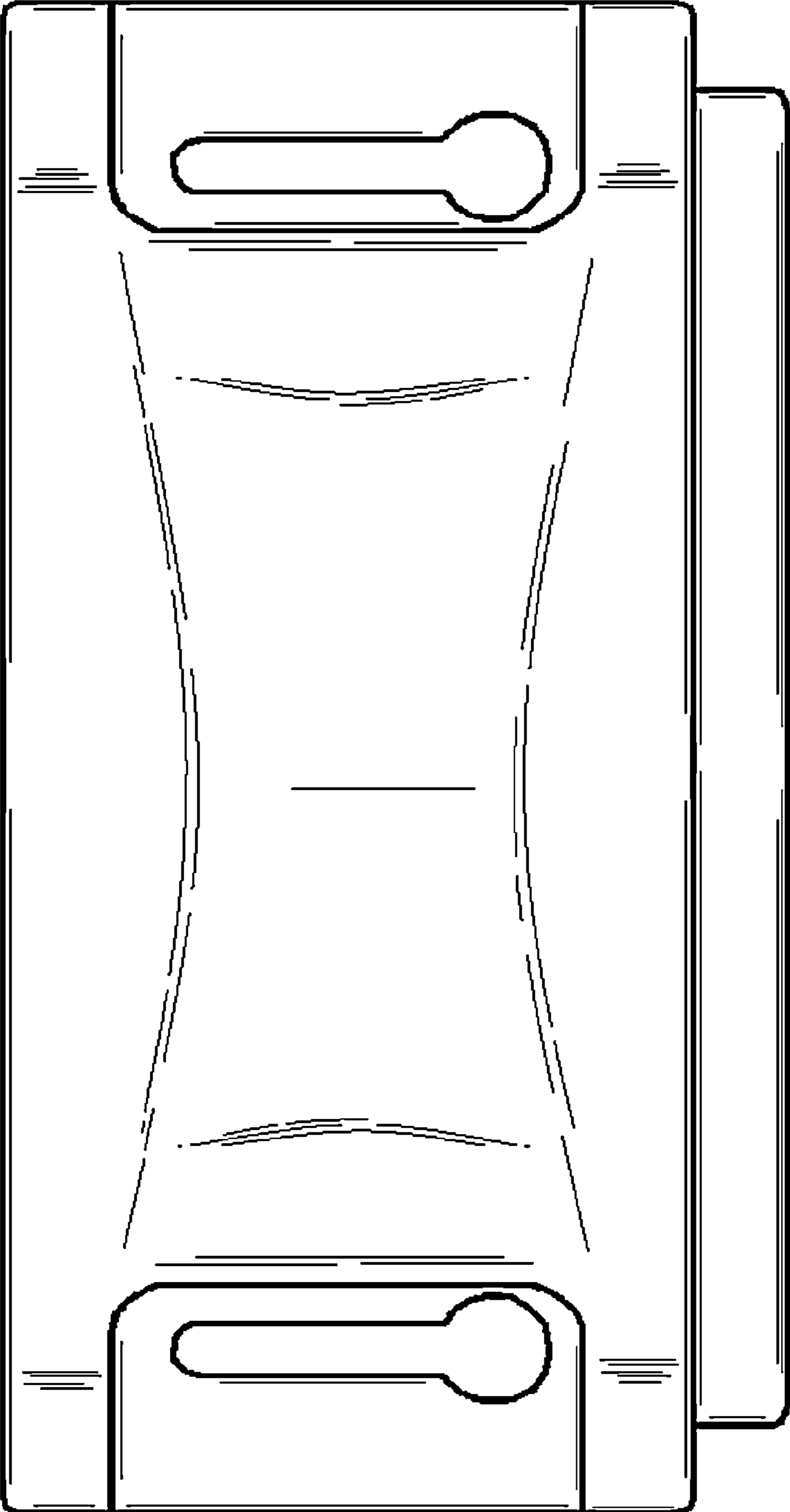

FIG. 3

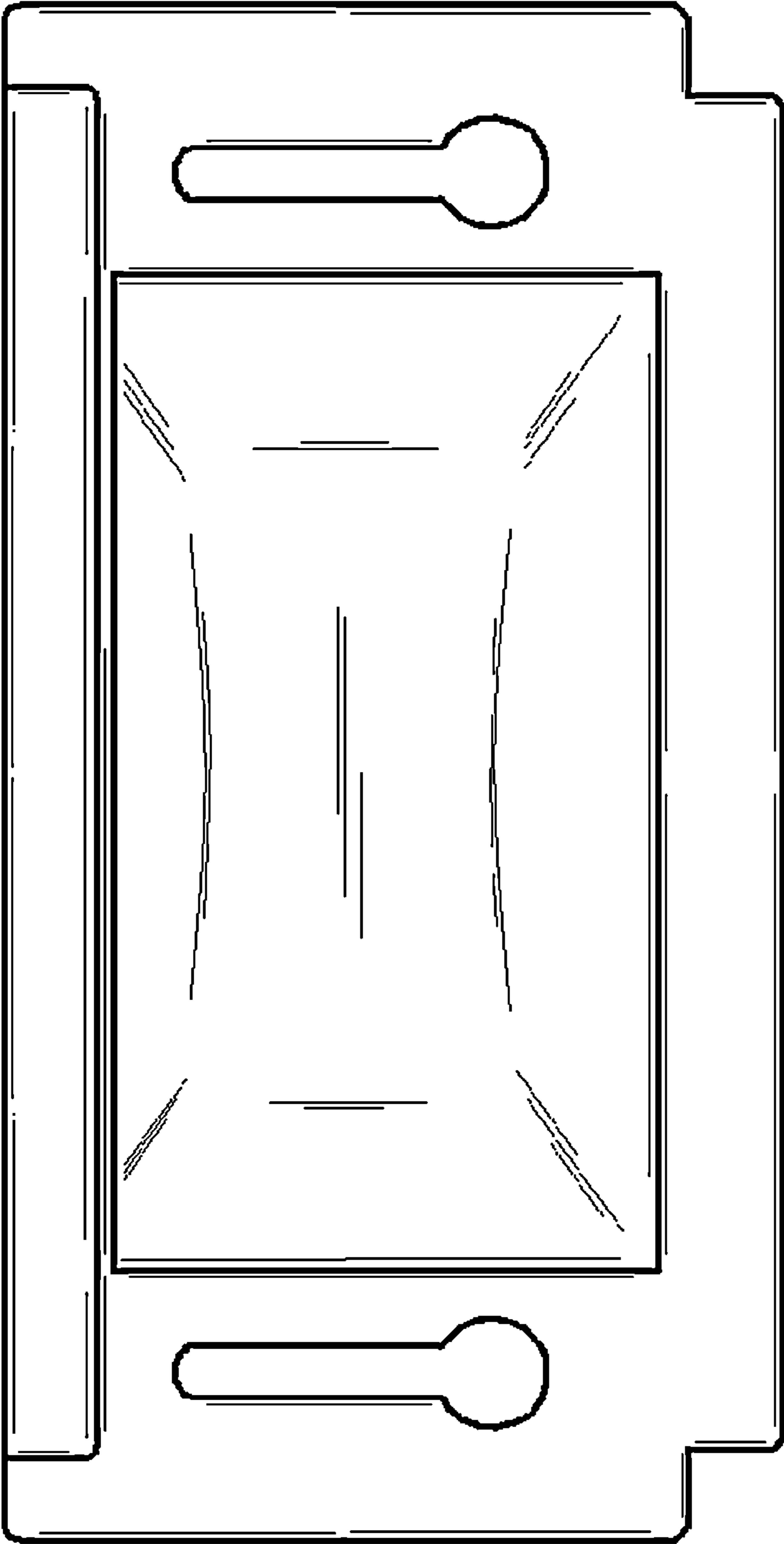

FIG. 4

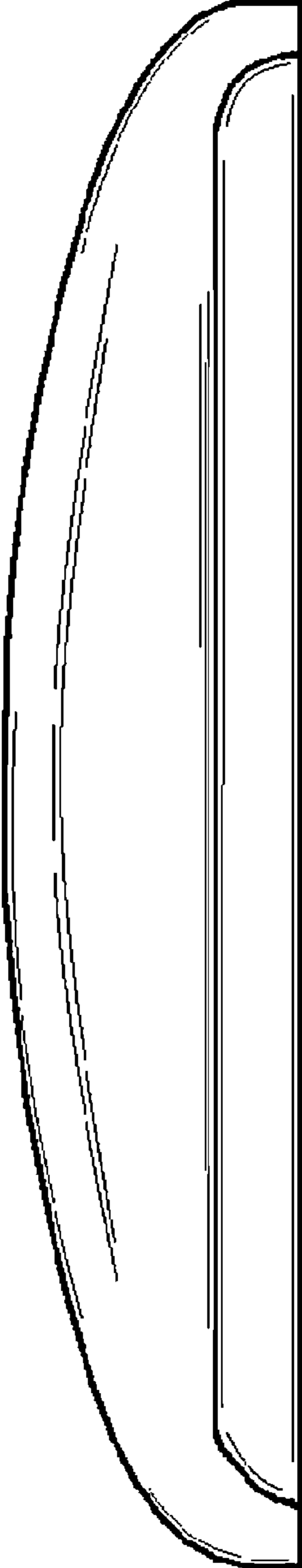

FIG. 5

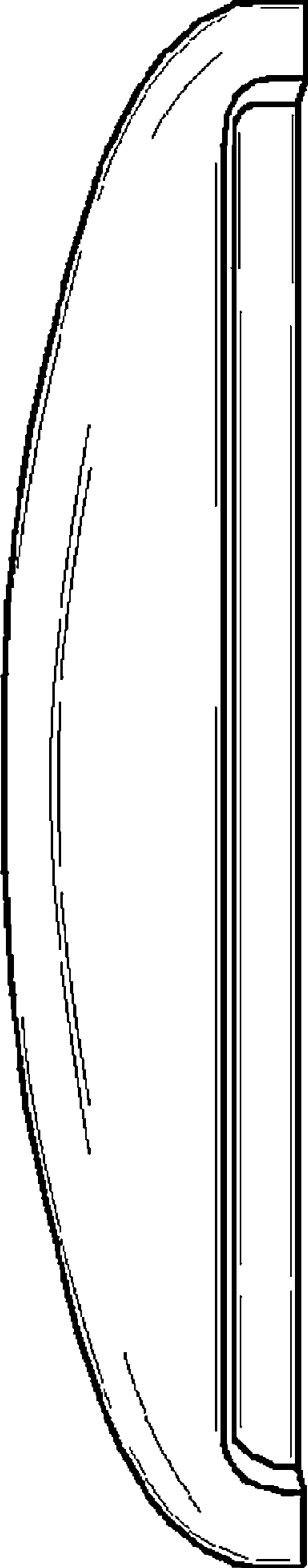

FIG. 6

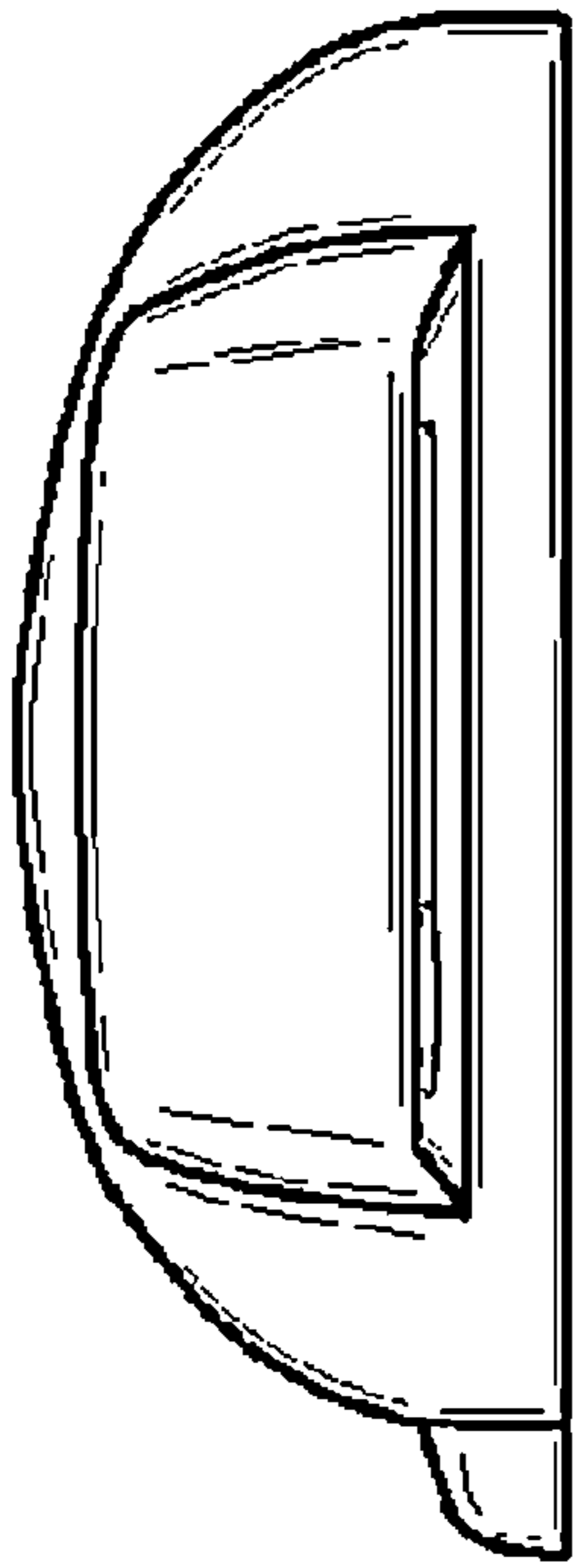

FIG. 7

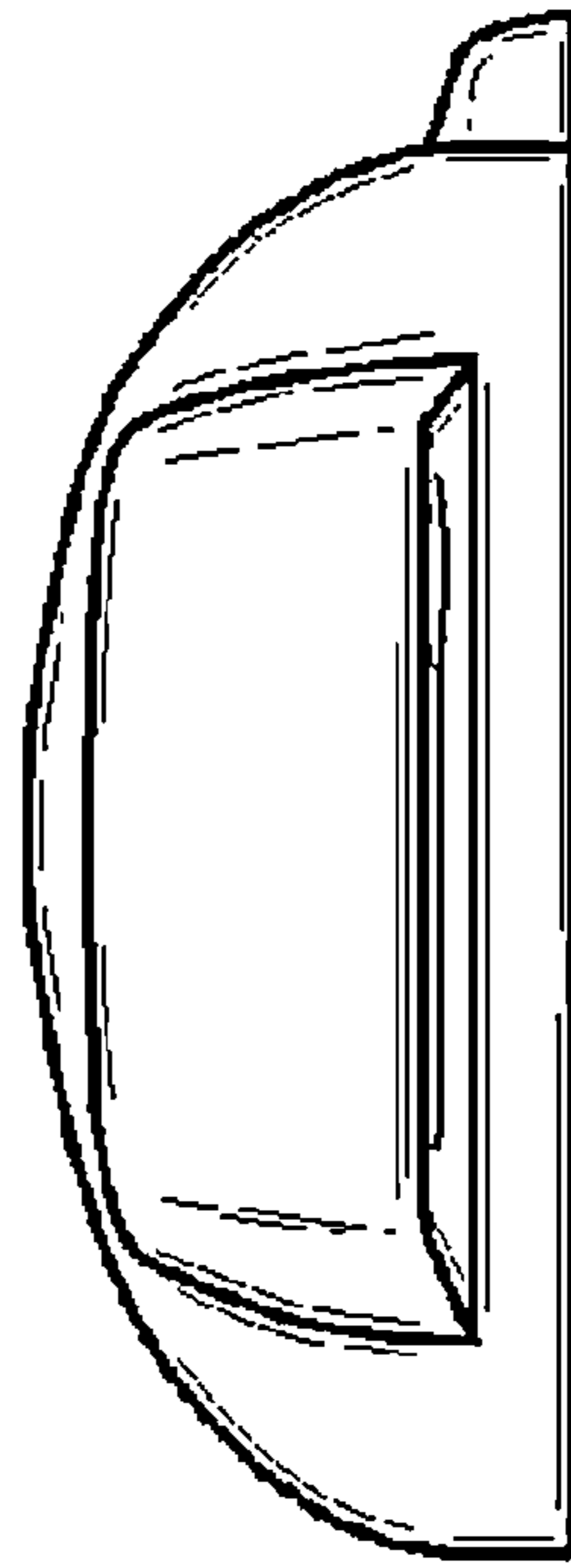

FIG. 8