



US00D703532S

(12) **United States Design Patent**
Merchant et al.

(10) **Patent No.:** **US D703,532 S**
(45) **Date of Patent:** **** Apr. 29, 2014**

(54) **OVER THE COUNTER MEDICINAL
CONTAINER WITH SURFACE
ORNAMENTATION**

(57) **CLAIM**

The ornamental design for an over the counter medicinal container with surface ornamentation, as shown and described.

(75) Inventors: **Jennifer Marie Merchant**, Cincinnati, OH (US); **Jean Martin Campbell**, Cincinnati, OH (US); **Scott Cunningham**, Cincinnati, OH (US); **Kevin Wimmer**, Union Township, OH (US)

DESCRIPTION

The present application file contains at least one drawing executed in color. Copies of this patent or patent application publication with color drawing(s) will be provided by the Office upon request and payment of the necessary fee.

(73) Assignee: **The Procter & Gamble Company**, Cincinnati, OH (US)

FIG. 1 is a perspective view of an over the counter medicinal container with surface ornamentation embodying our new design;

(**) Term: **14 Years**

FIG. 2 is a front view thereof;

(21) Appl. No.: **29/401,256**

FIG. 3 is a rear view thereof;

(22) Filed: **Sep. 9, 2011**

FIG. 4 is left side view thereof;

(51) **LOC (10) Cl.** **09-07**

FIG. 5 is a right side view thereof;

(52) **U.S. Cl.**

FIG. 6 is a top view thereof;

USPC **D9/434**

FIG. 7 is a bottom view thereof;

(58) **Field of Classification Search**

USPC D9/748, 713, 702, 652, 600, 457, 434,
D9/433, 414, 415; D20/40, 29, 28, 27, 23,
D20/22, 10; 224/906; 206/784, 525, 525.1,
206/461, 457, 458

FIG. 8 is a perspective view of a second embodiment of an over the counter medicinal container with surface ornamentation embodying our new design;

See application file for complete search history.

FIG. 9 is a front view thereof;

(56) **References Cited**

U.S. PATENT DOCUMENTS

D587,111 S *	2/2009	Seol et al.	D9/432
D589,359 S *	3/2009	Kusumi	D9/600
D608,636 S *	1/2010	Seol	D9/432
D611,832 S *	3/2010	Champion et al.	D9/600
D622,774 S *	8/2010	Seum et al.	D20/22

FIG. 10 is a rear view thereof;

FIG. 11 is a left side view thereof;

FIG. 12 is a right side view thereof;

FIG. 13 is a top view thereof;

FIG. 14 is a bottom view thereof;

FIG. 15 is a perspective view of a third embodiment of an over the counter medicinal container with surface ornamentation embodying our new design;

FIG. 16 is a front view thereof;

FIG. 17 is a rear view thereof;

FIG. 18 is a left side view thereof;

FIG. 19 is a right side view thereof;

FIG. 20 is a top view thereof;

FIG. 21 is a bottom view thereof;

FIG. 22 is a perspective view of a fourth embodiment of an over the counter medicinal container with surface ornamentation embodying our new design;

FIG. 23 is a front view thereof;

FIG. 24 is a left side view thereof;

FIG. 25 is a right side view thereof;

* cited by examiner

Primary Examiner — Randall Gholson

(74) *Attorney, Agent, or Firm* — Alexandra S. Anoff

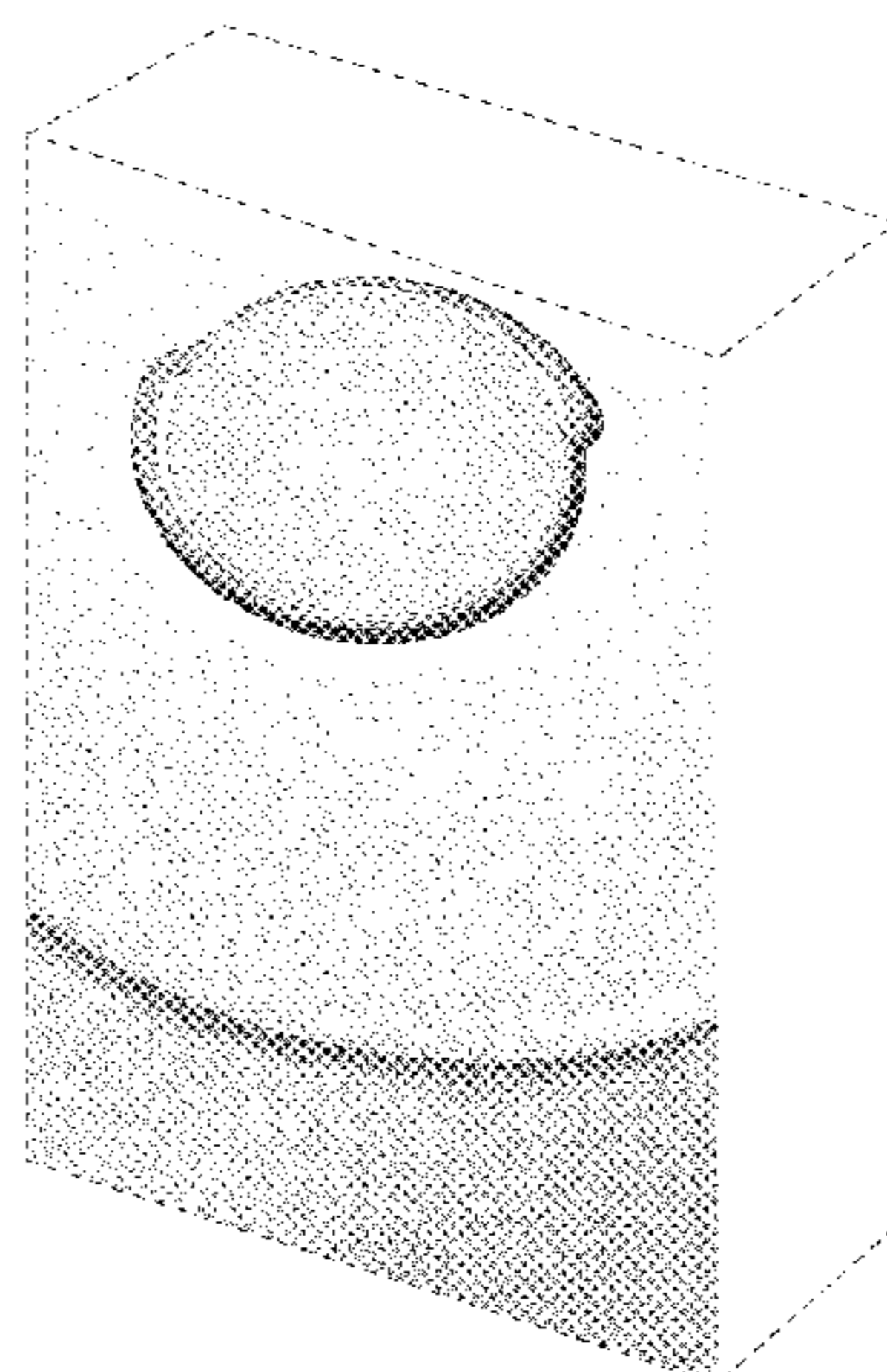

FIG. 26 is a rear view thereof;
FIG. 27 is a top view thereof;
FIG. 28 is a bottom view thereof;
FIG. 29 is a perspective view of a fifth embodiment of an over the counter medicinal container with surface ornamentation embodying our new design;
FIG. 30 is a front view thereof;
FIG. 31 is a left side view thereof;
FIG. 32 is a right side view thereof;

FIG. 33 is a rear view thereof;
FIG. 34 is a top view thereof; and,
FIG. 35 is a bottom view thereof.
Broken lines in the figures depict environmental subject matter and form no part of the claimed design. In FIG. 1-2, and FIG. 22-25, the stippling represents color contrast.

**1 Claim, 12 Drawing Sheets
(6 of 12 Drawing Sheet(s) Filed in Color)**

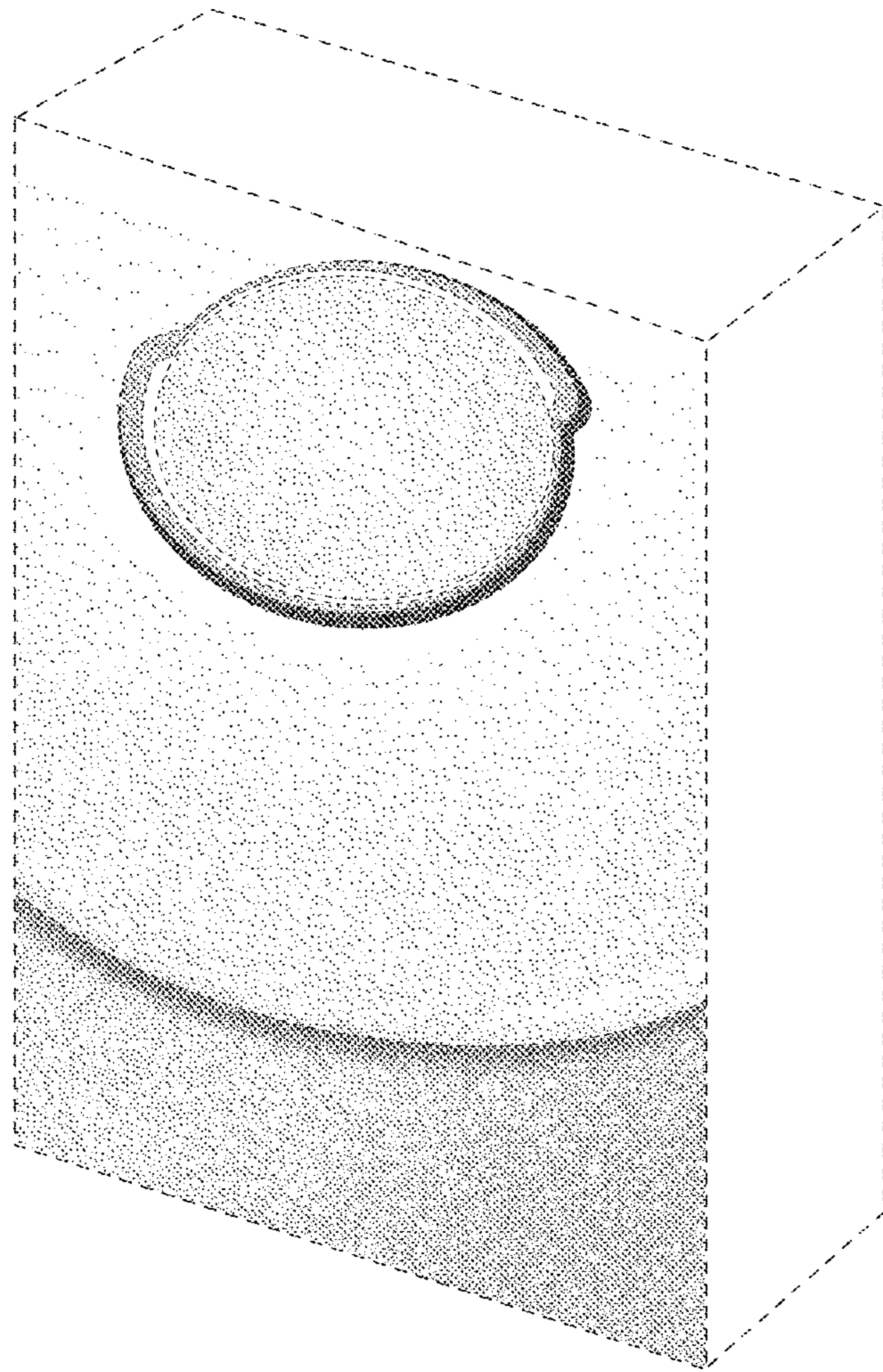

Fig. 1

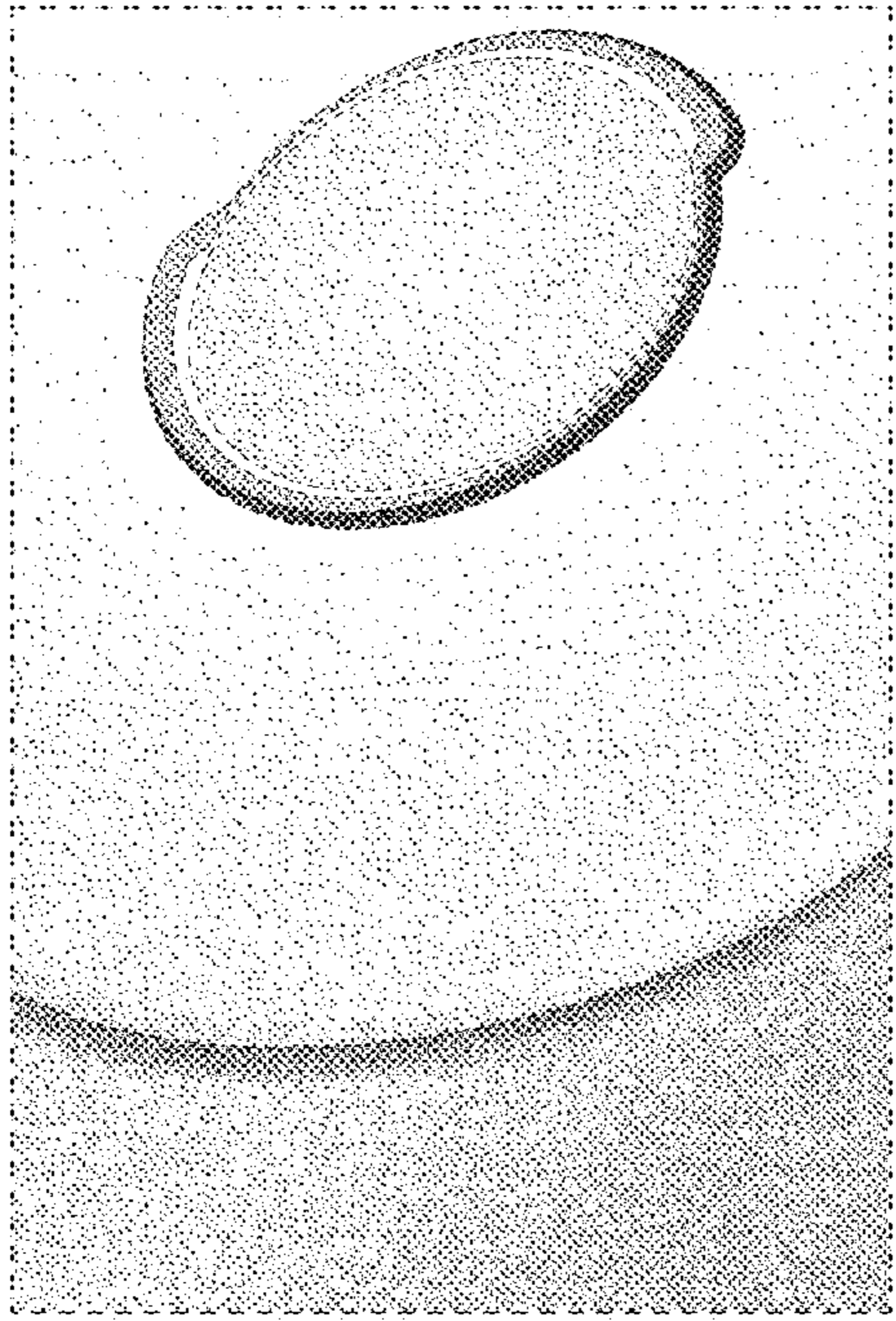

Fig. 2

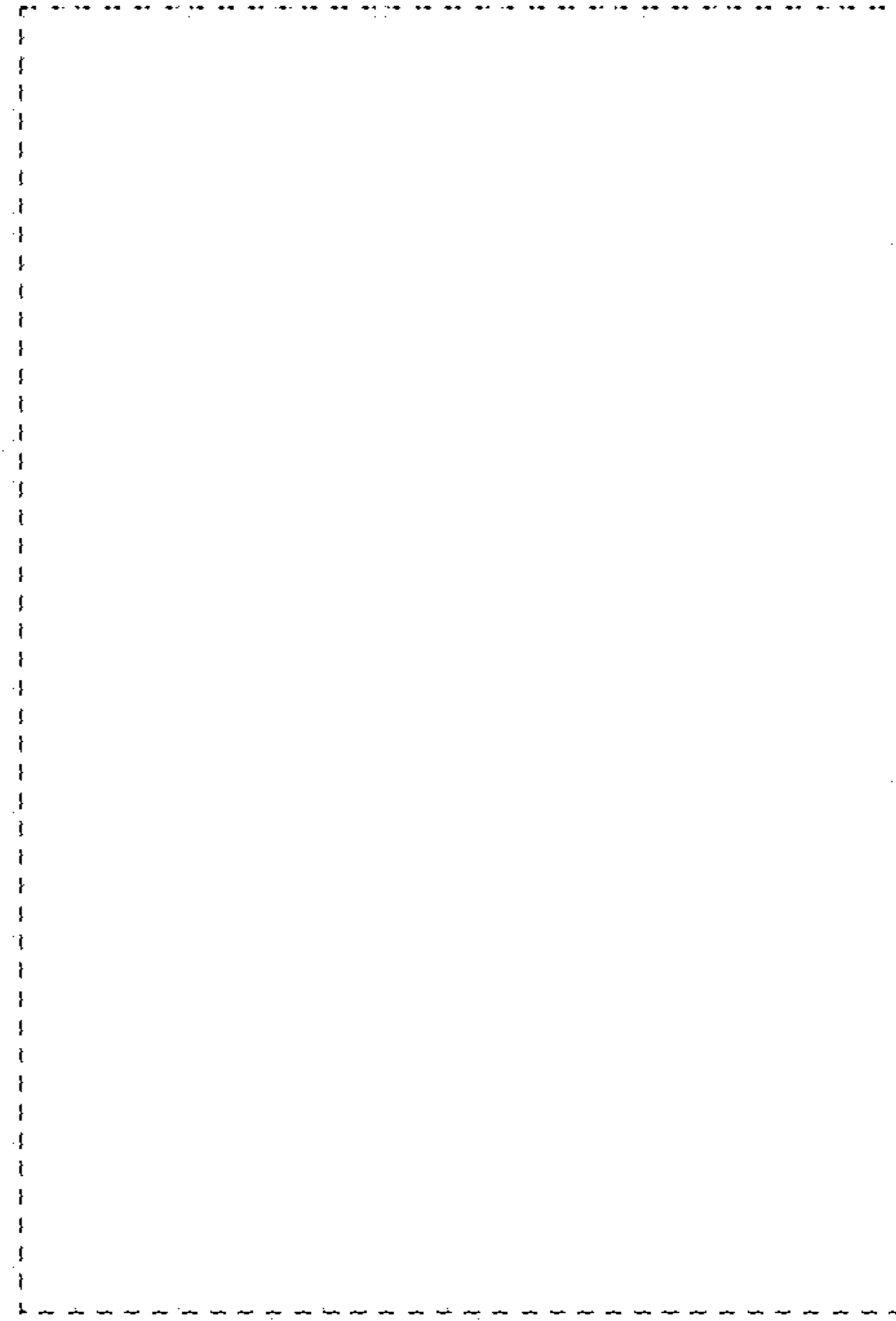

Fig. 3

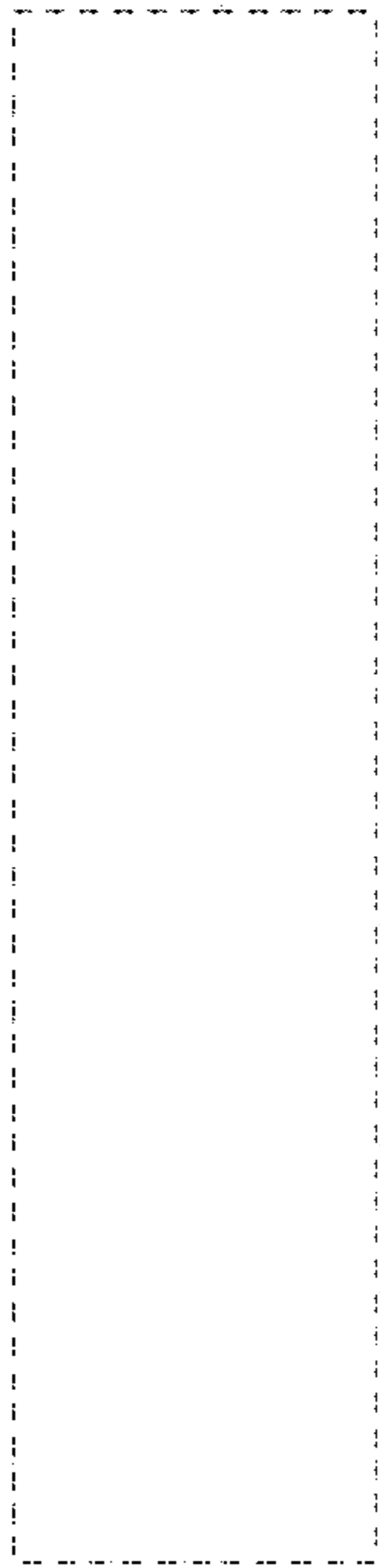

Fig. 4

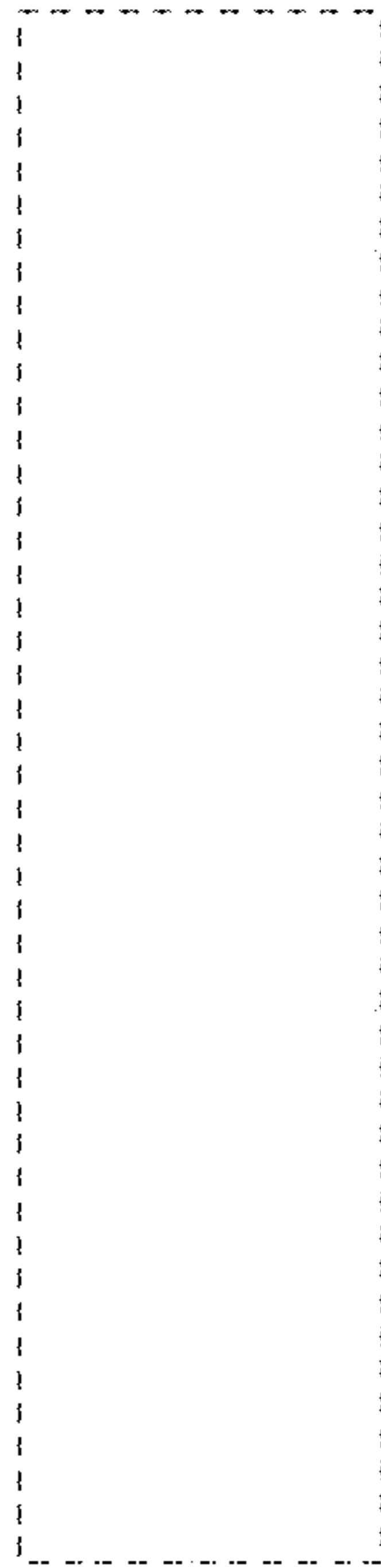

Fig. 5

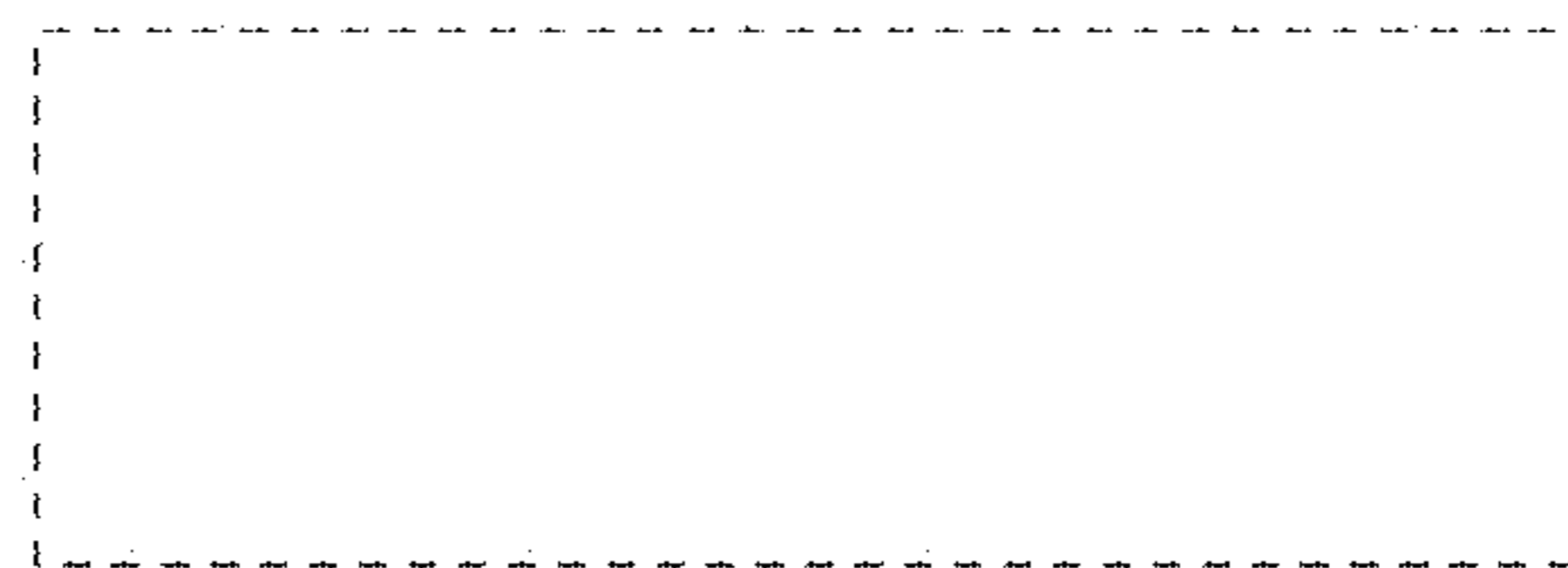

Fig. 6

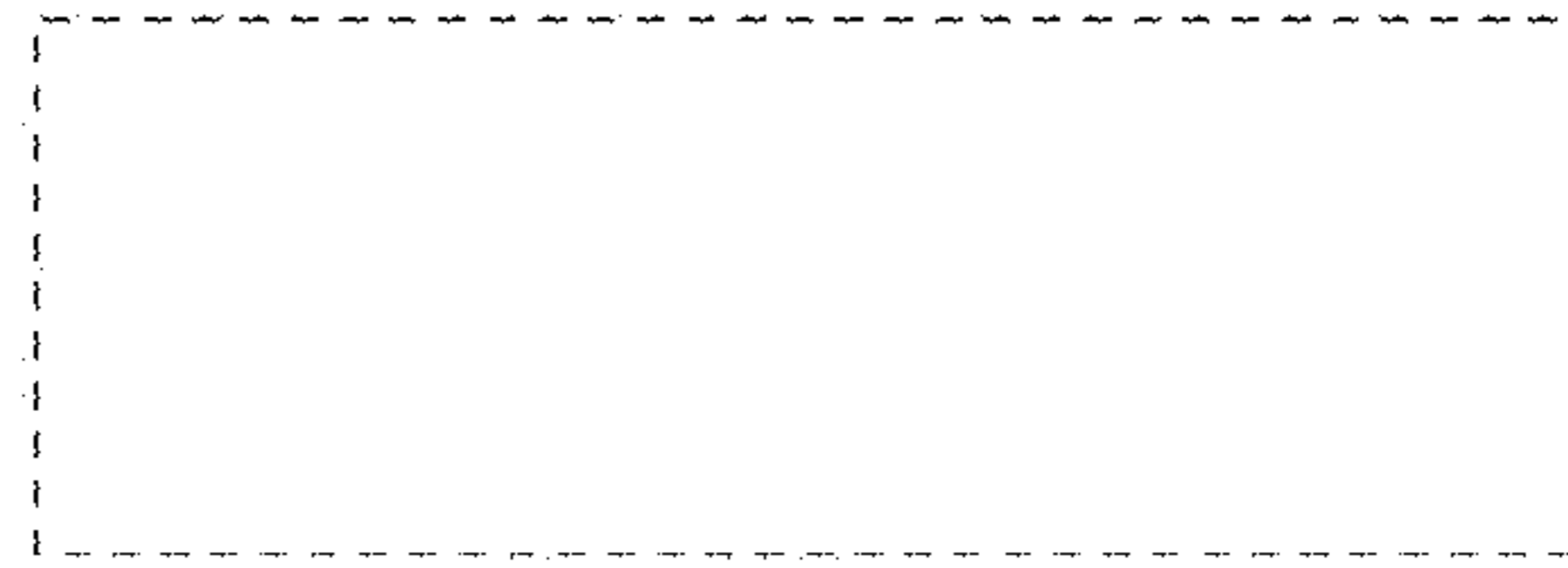

Fig. 7

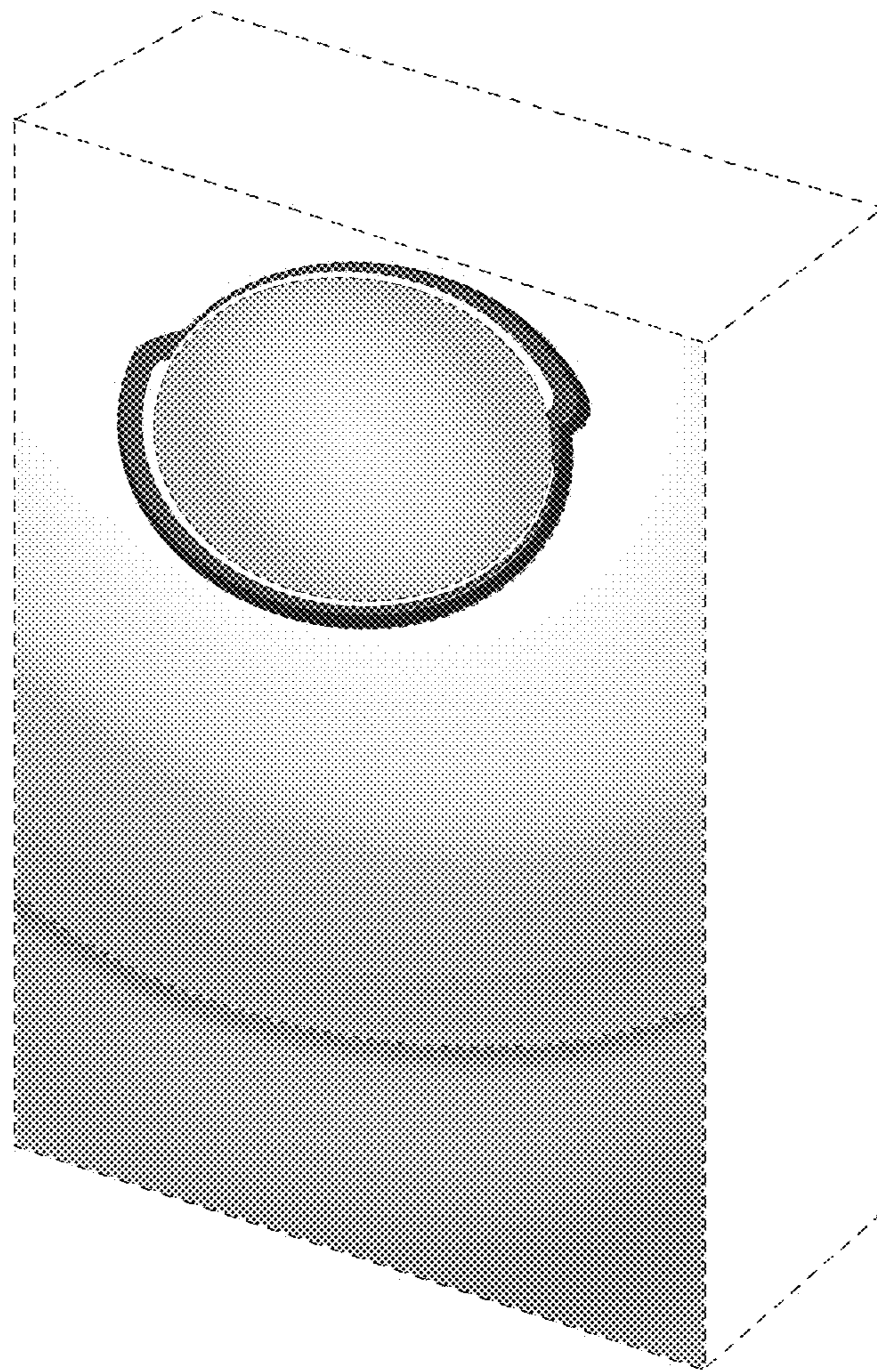

Fig. 8

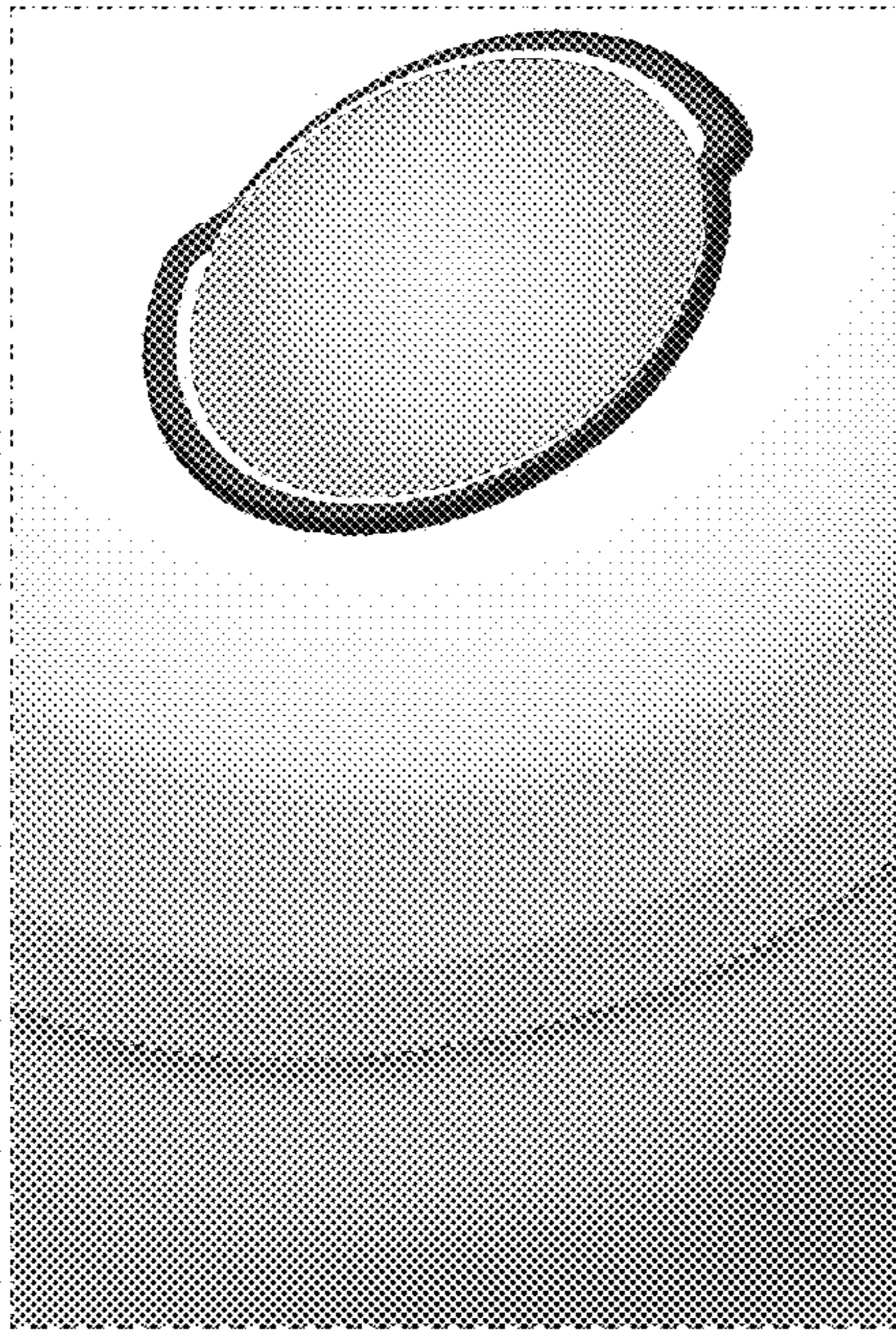

Fig. 9

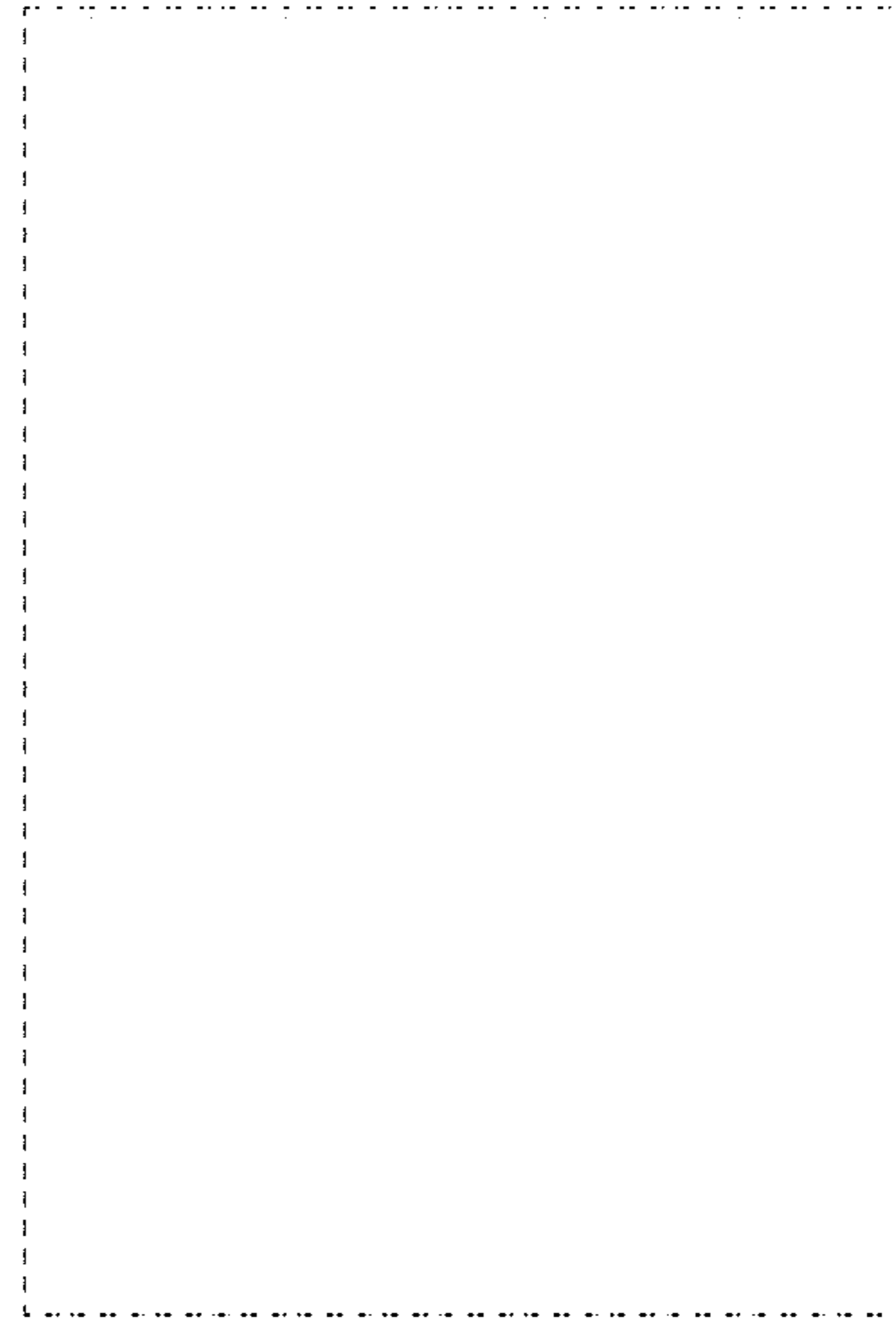

Fig. 10

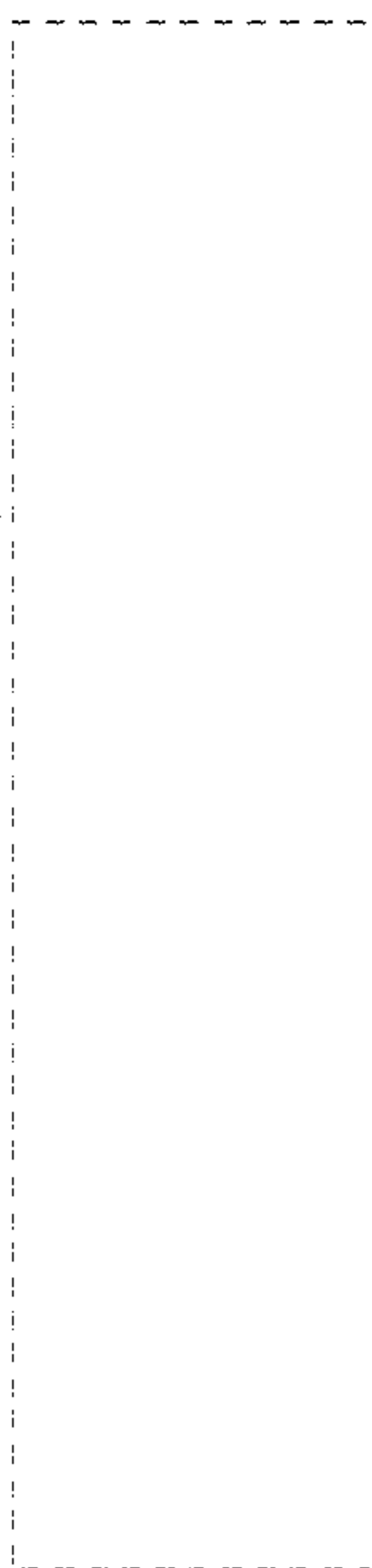

Fig. 11

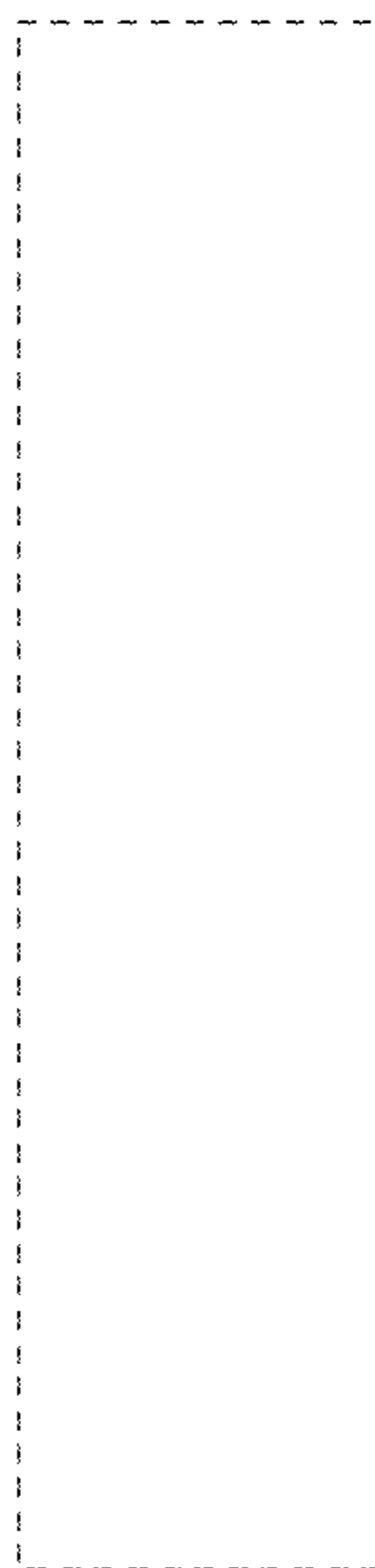

Fig. 12



Fig. 13



Fig. 14

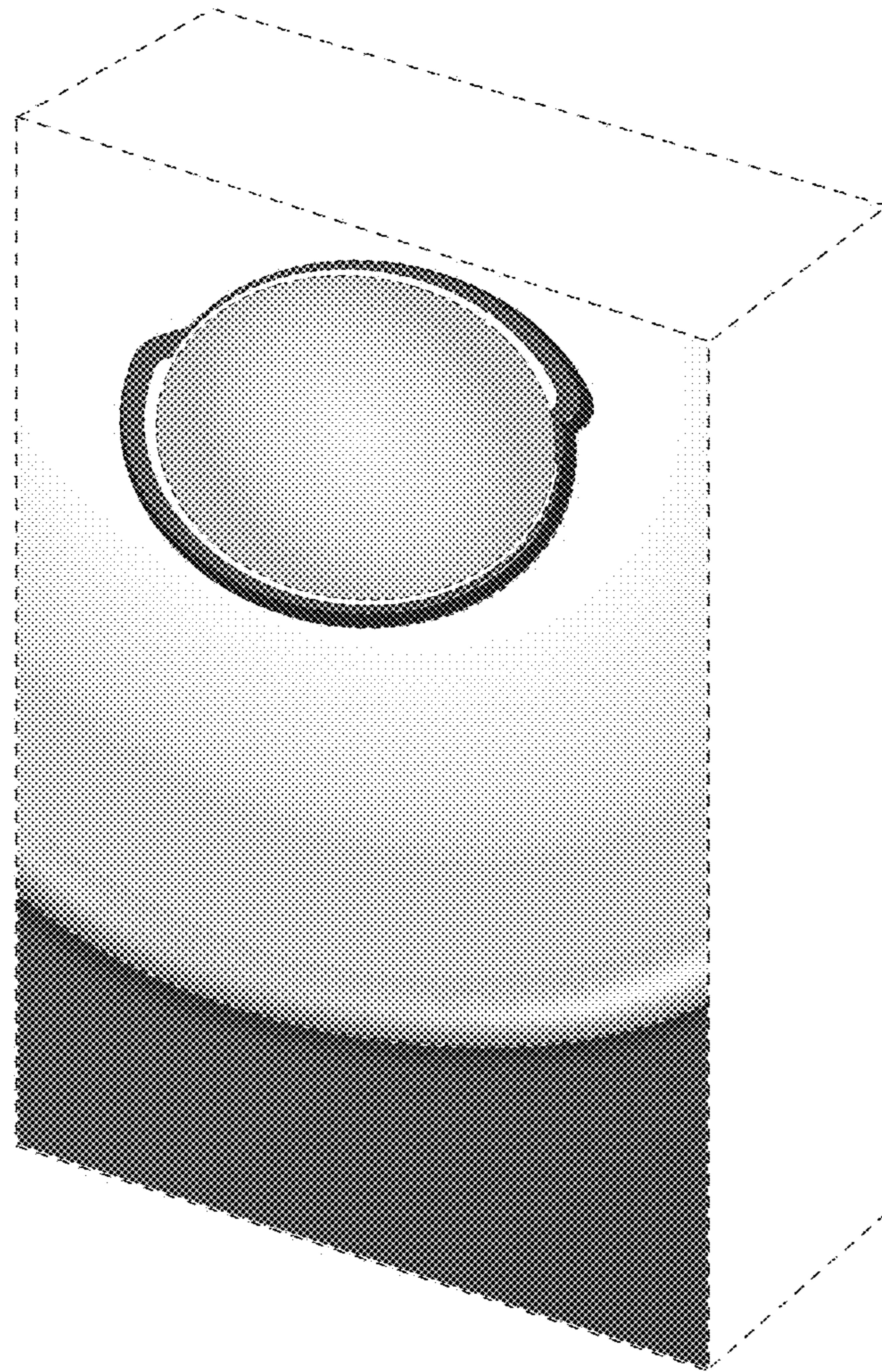

Fig. 15

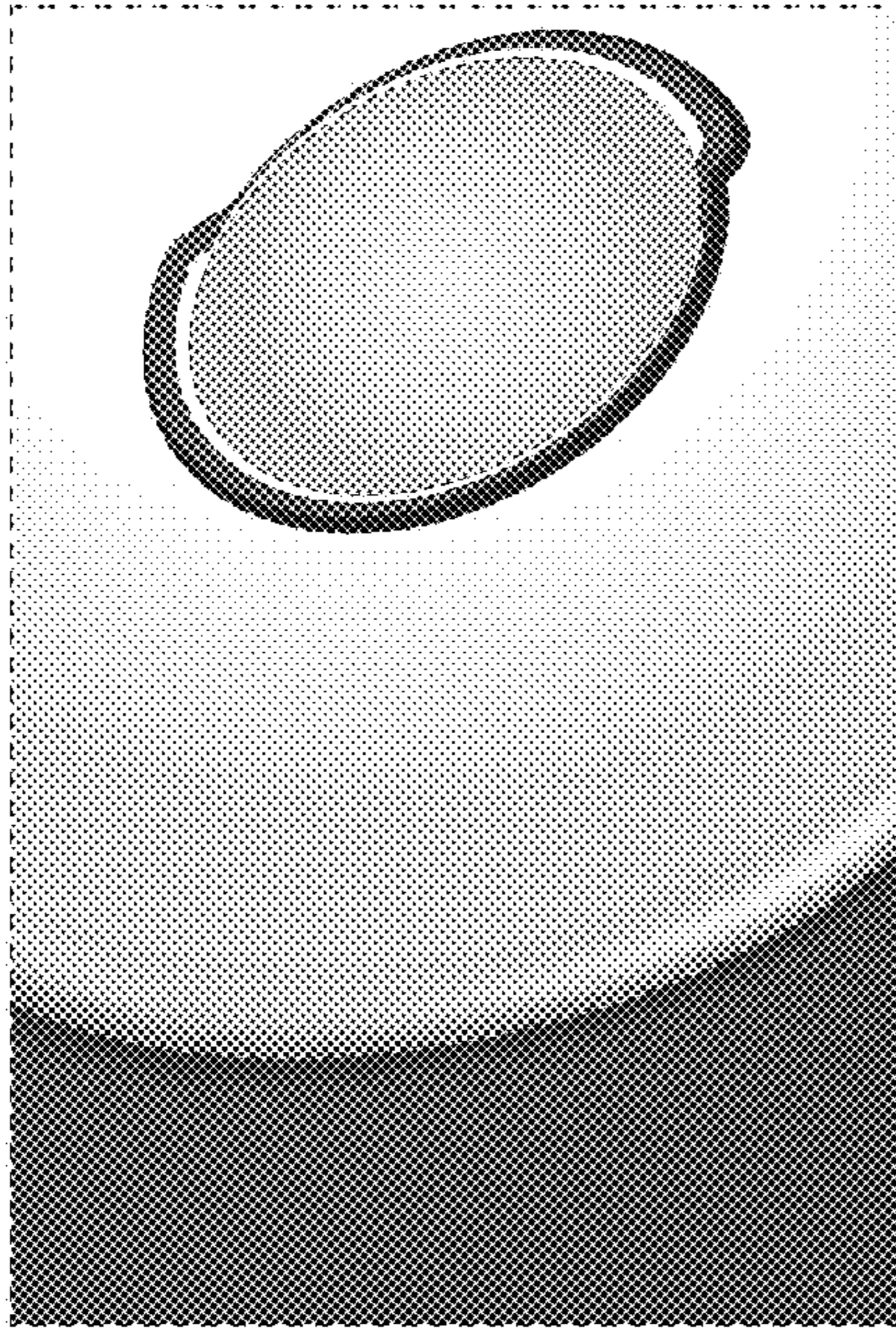

Fig. 16

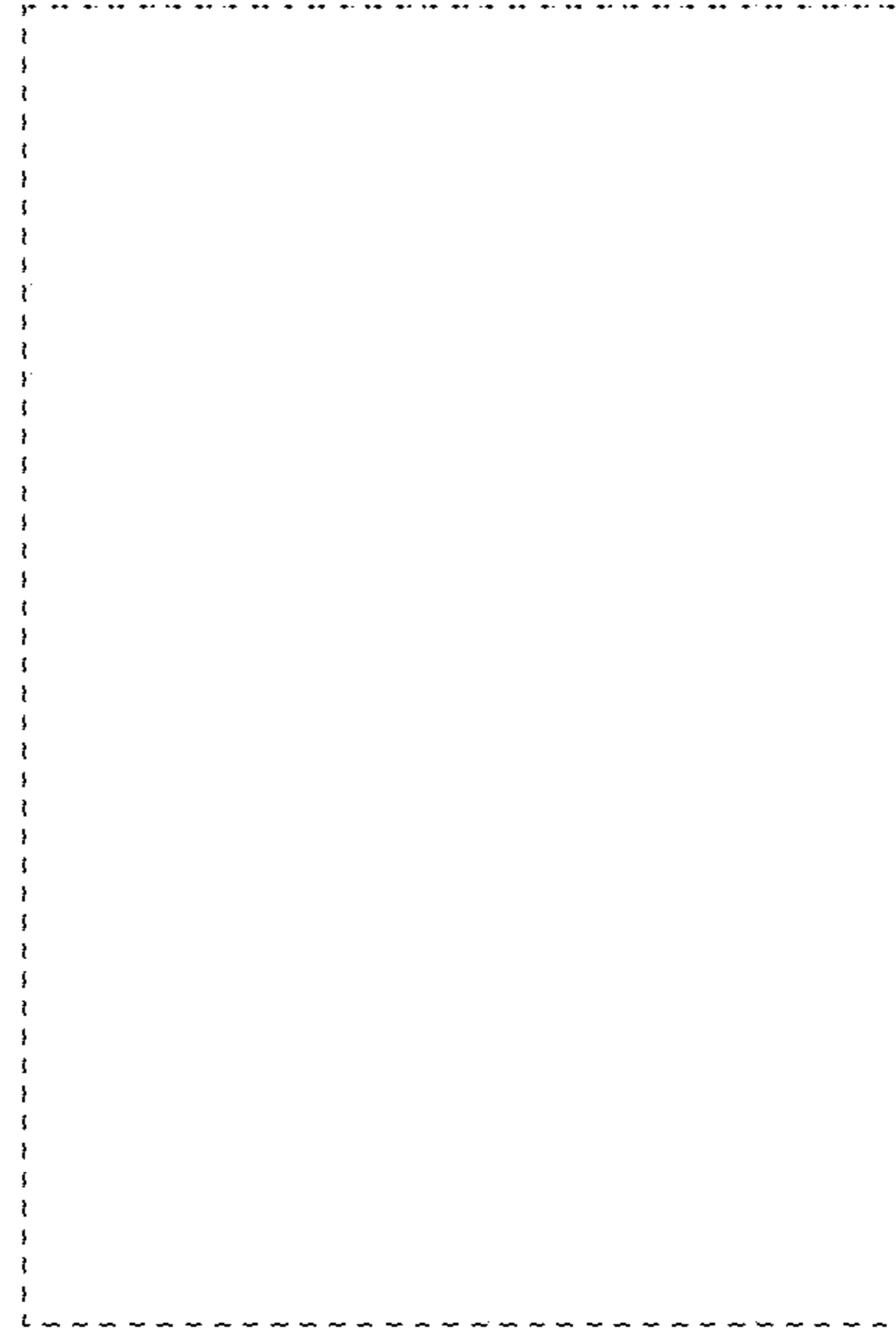

Fig. 17

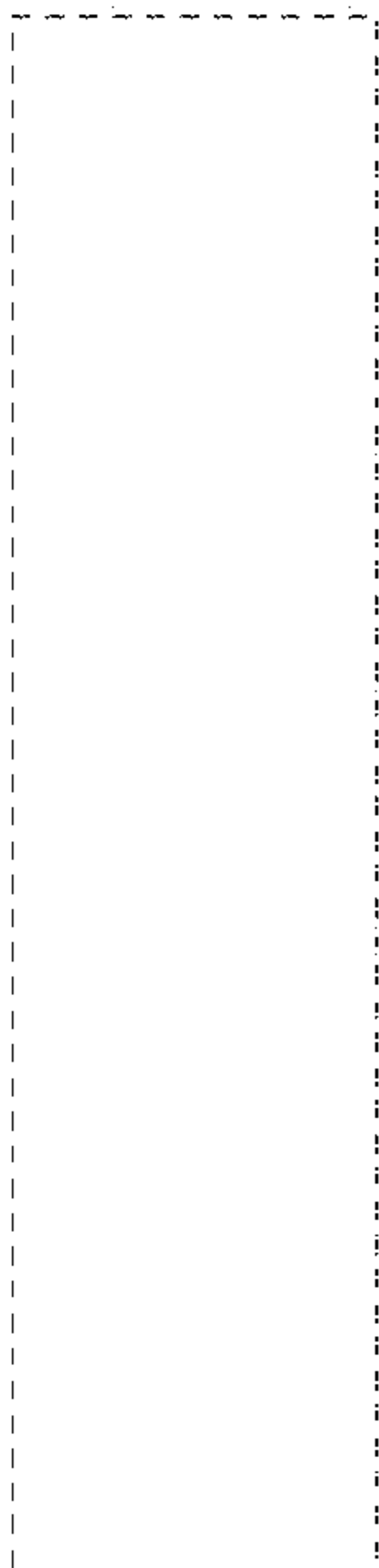

Fig. 18

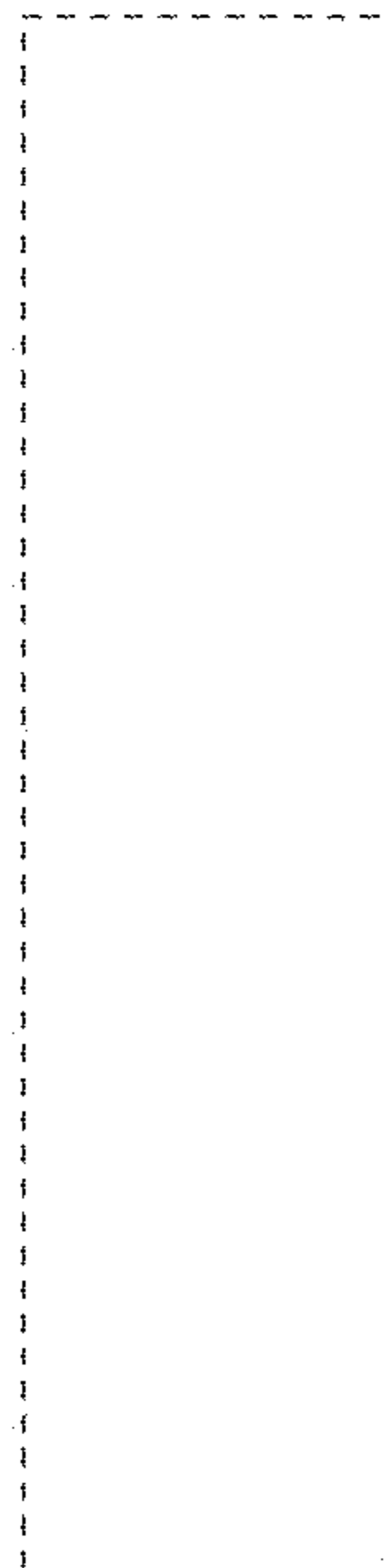

Fig. 19



Fig. 20



Fig. 21

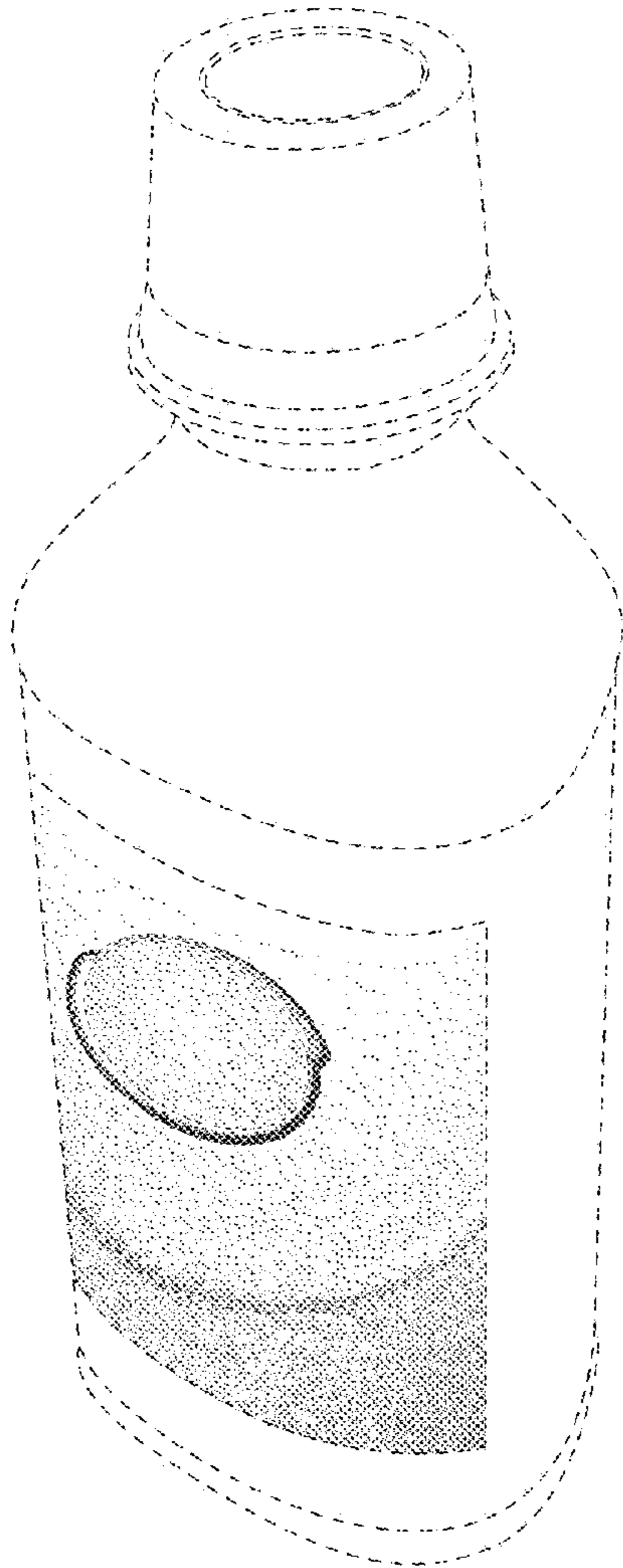

Fig. 22

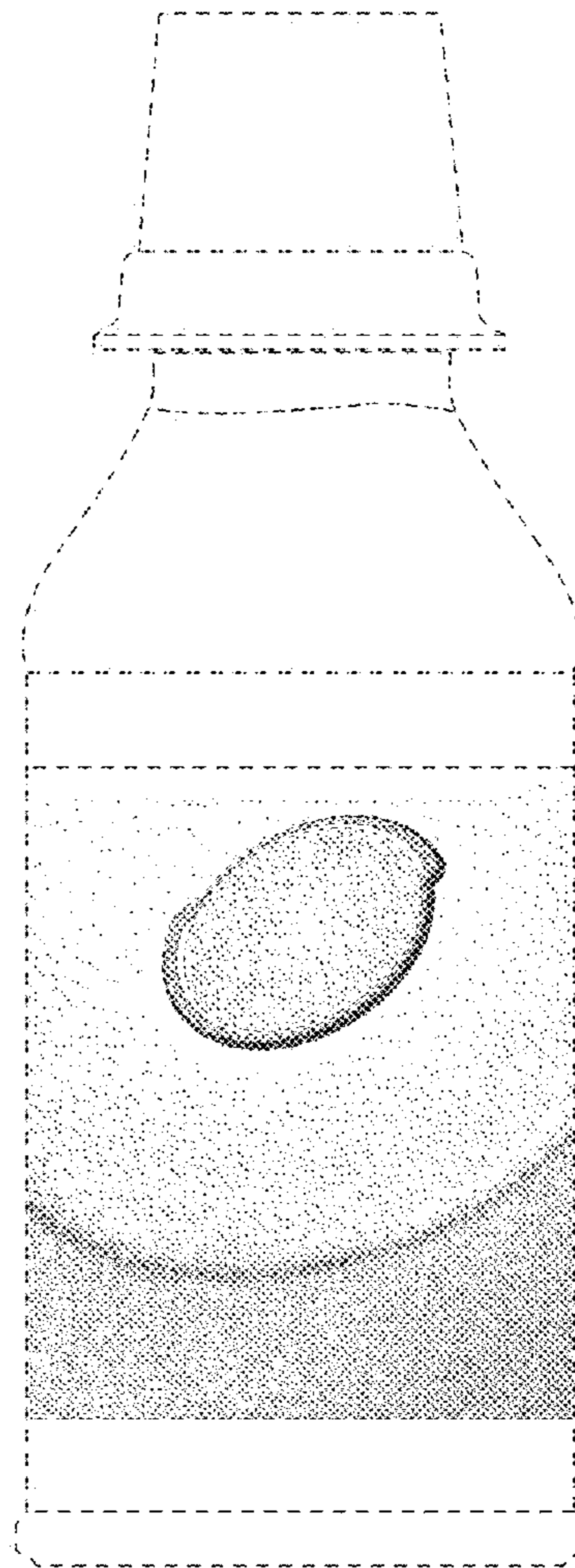

Fig. 23

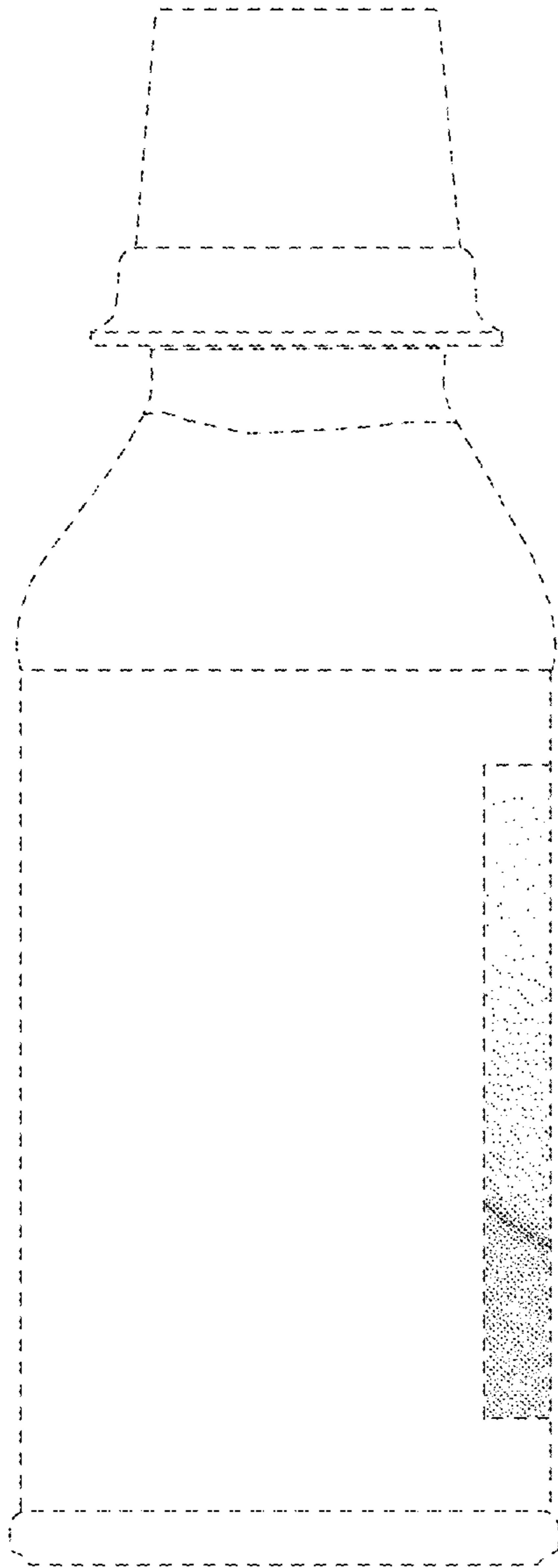

Fig. 24

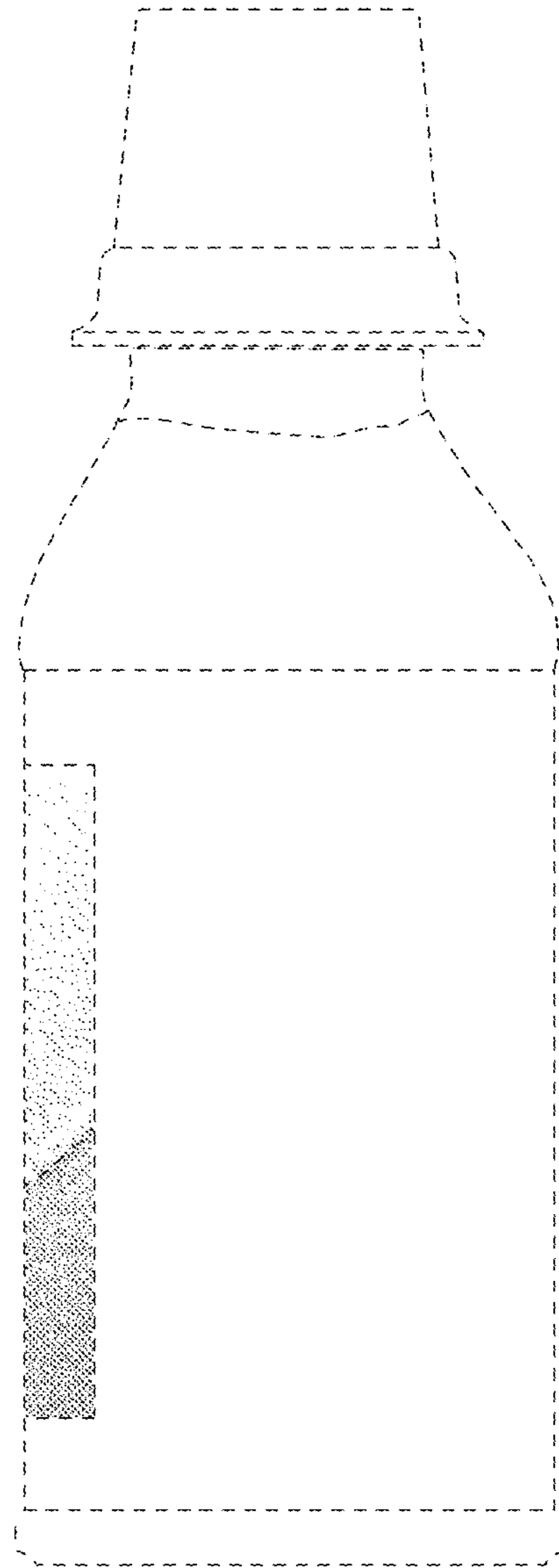

Fig. 25

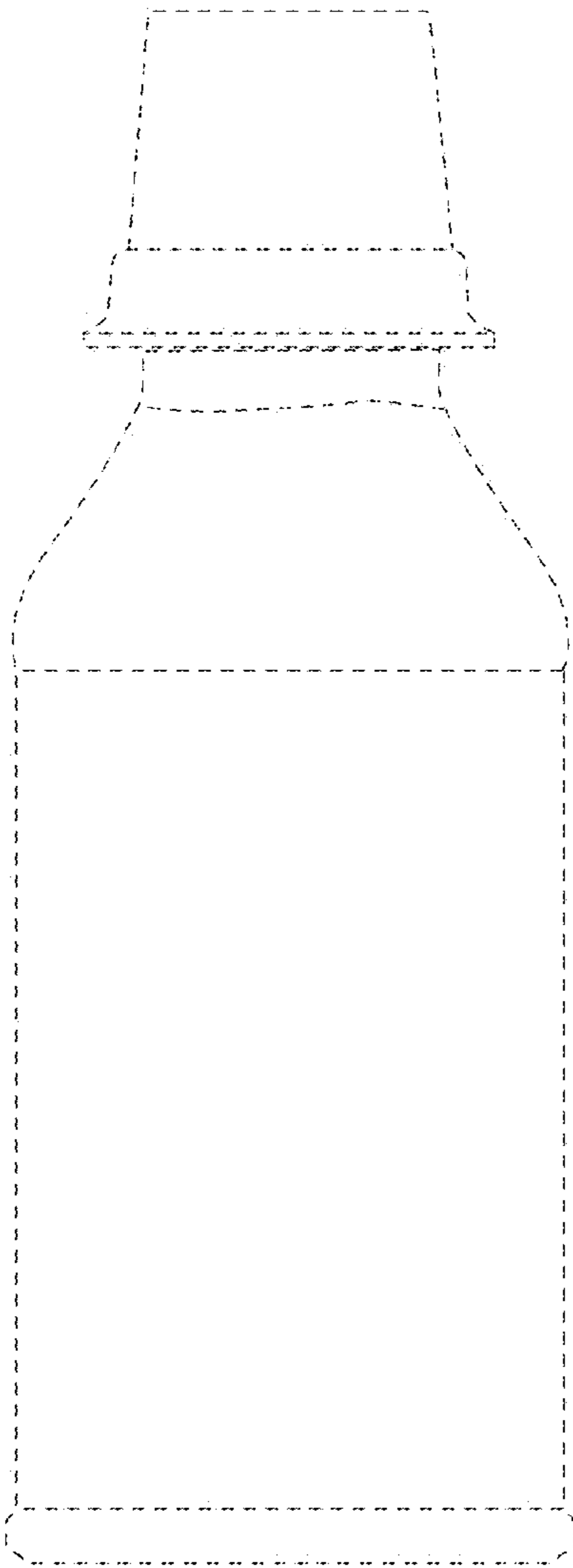

Fig. 26

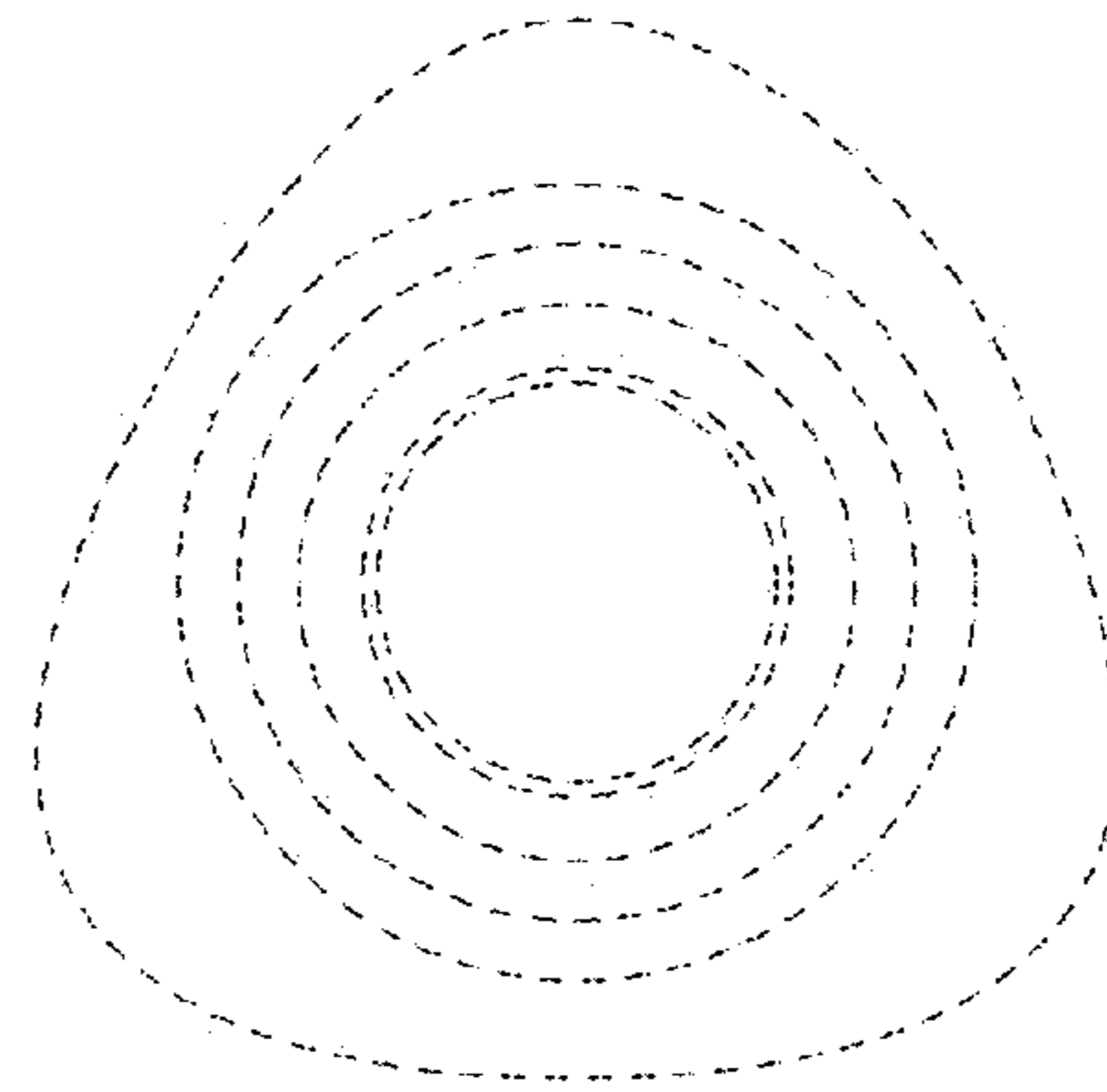

Fig. 27

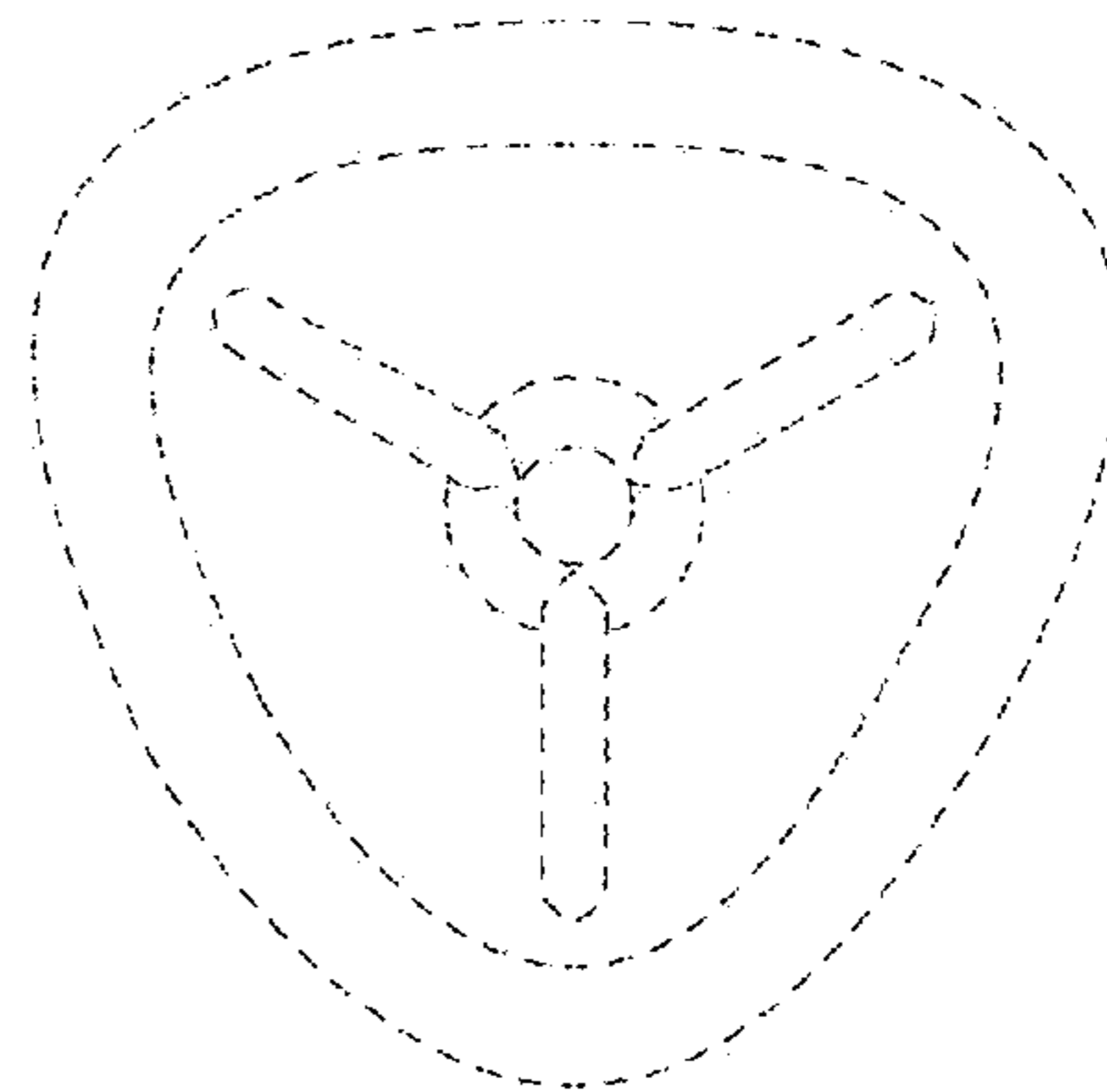

Fig. 28

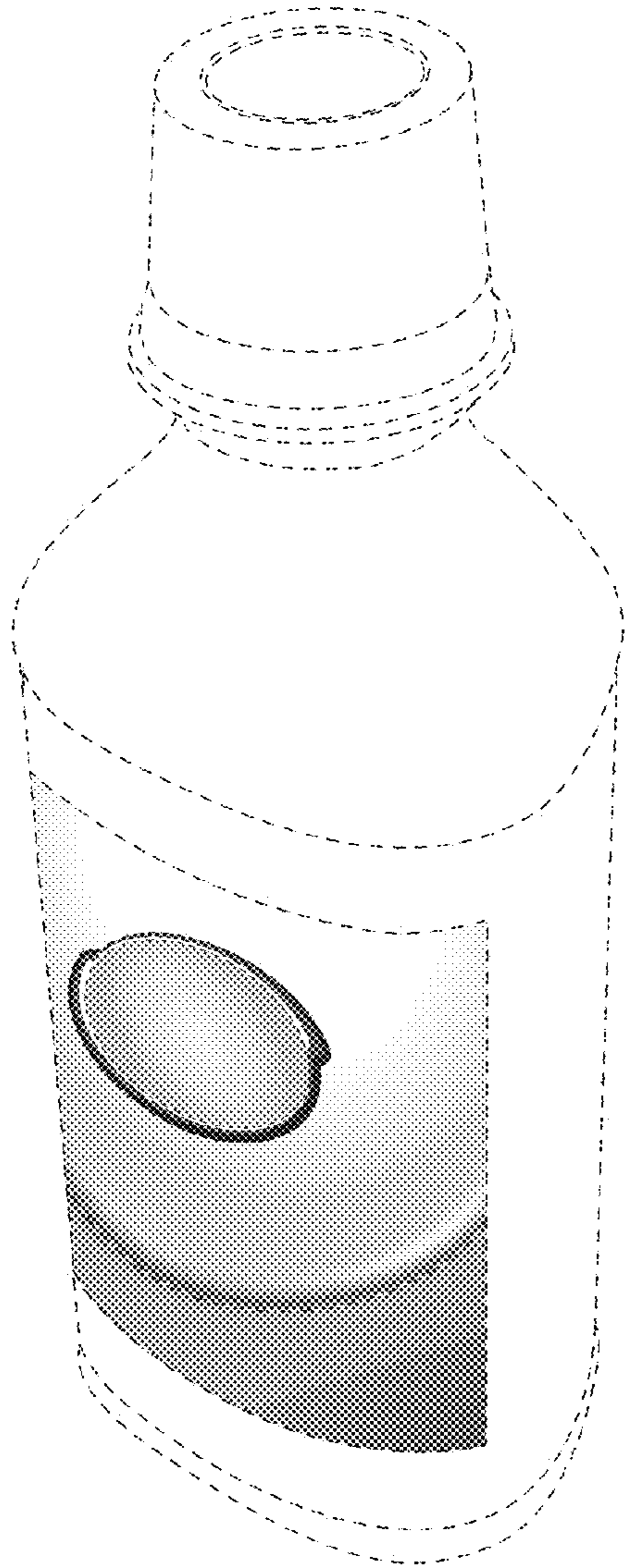

Fig. 29

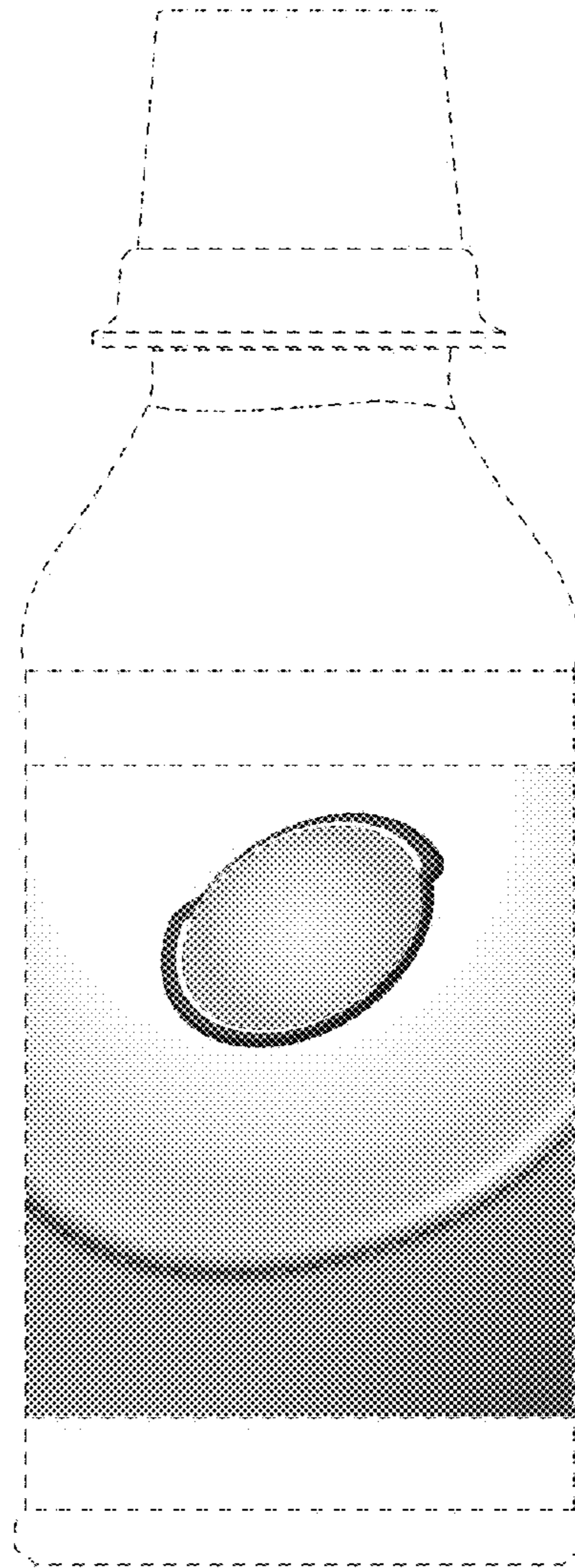

Fig. 30

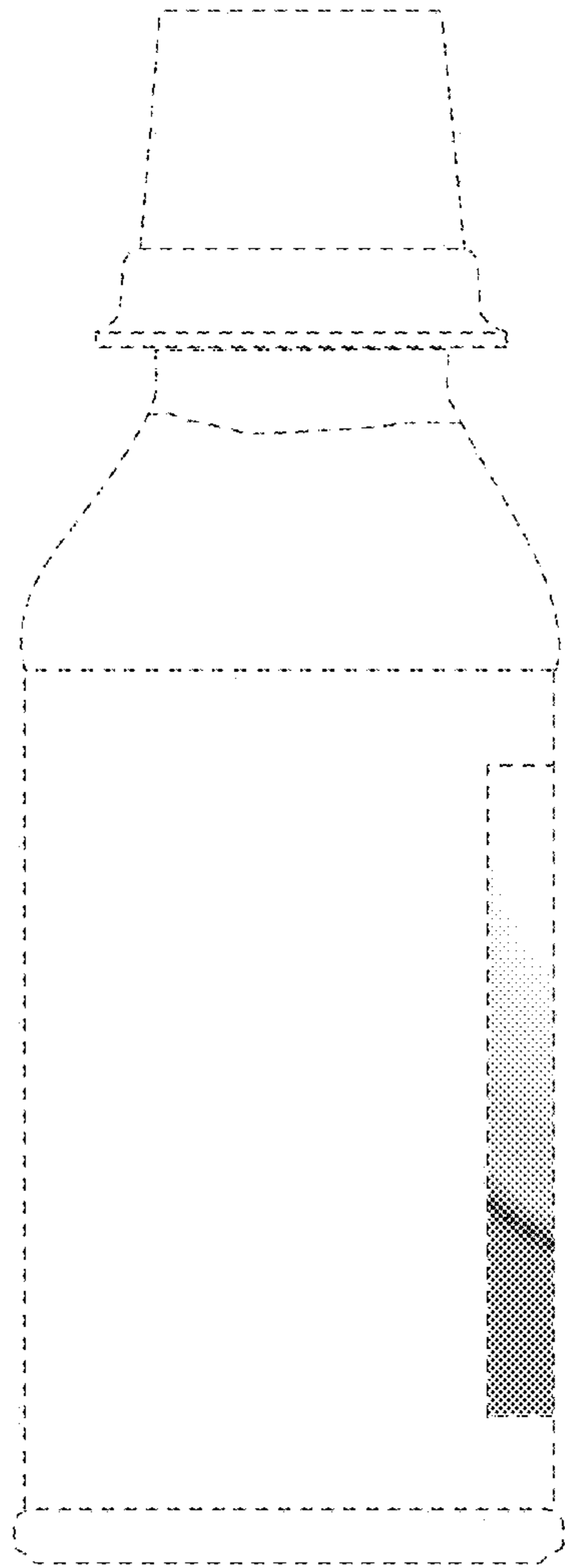

Fig. 31

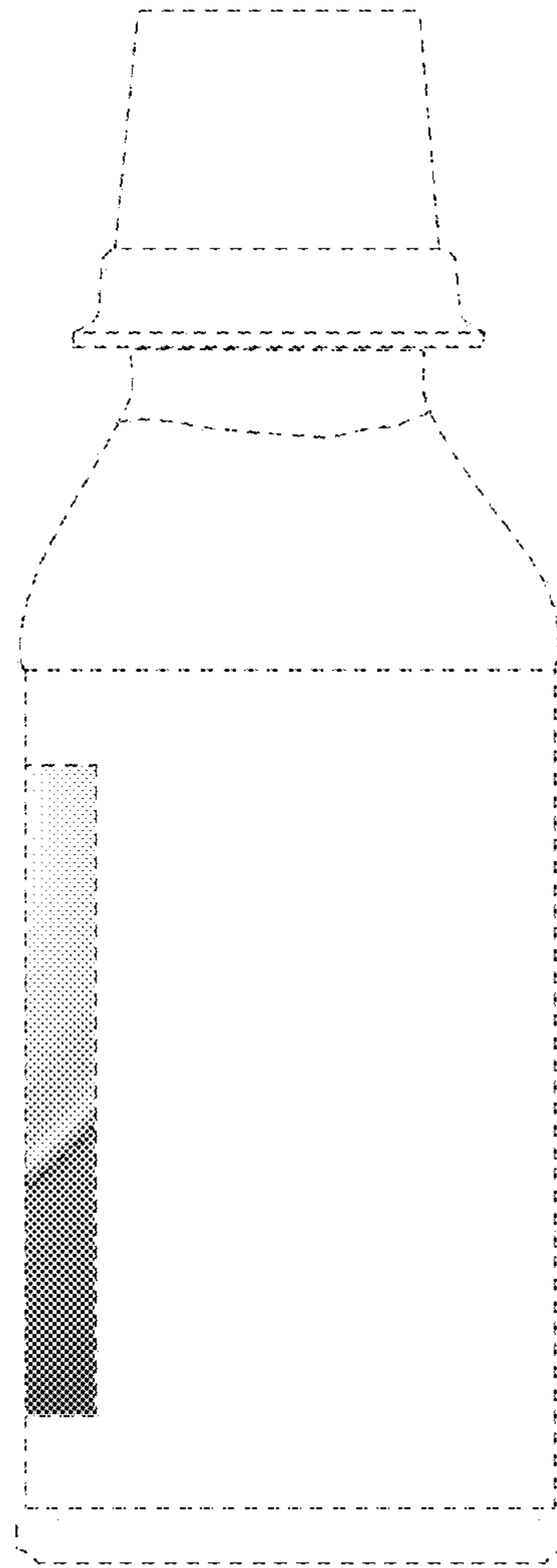

Fig. 32

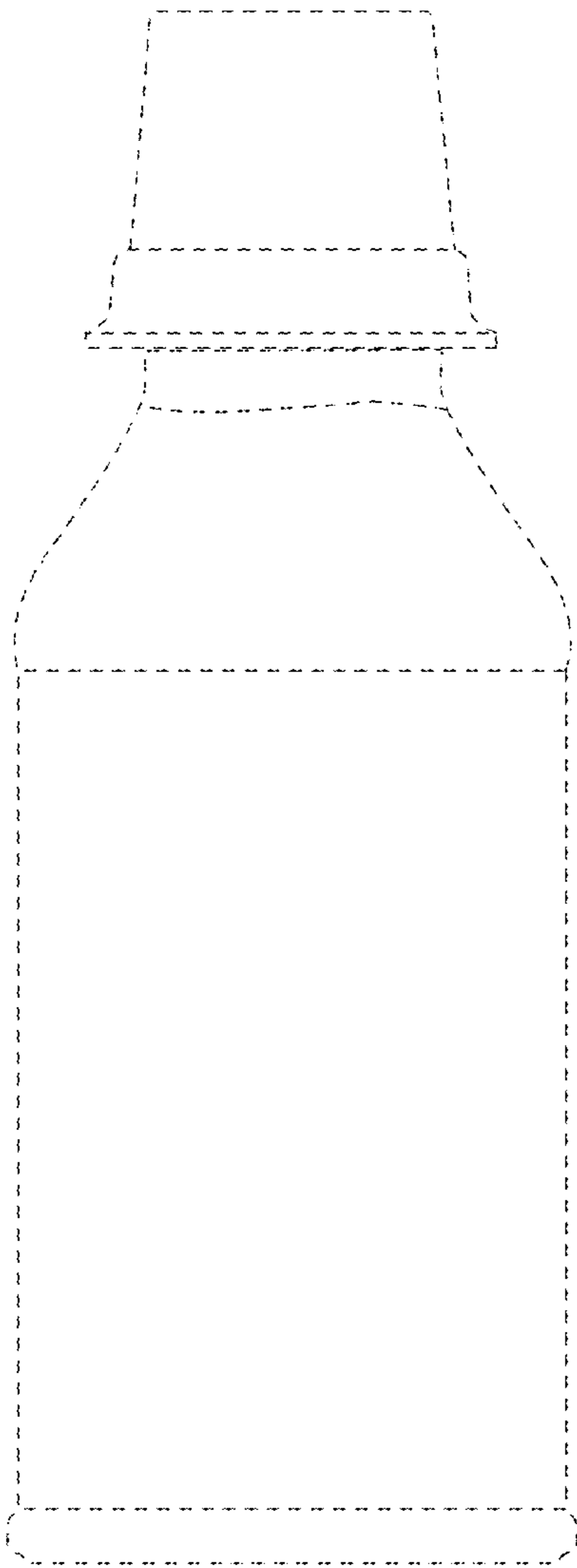

Fig. 33

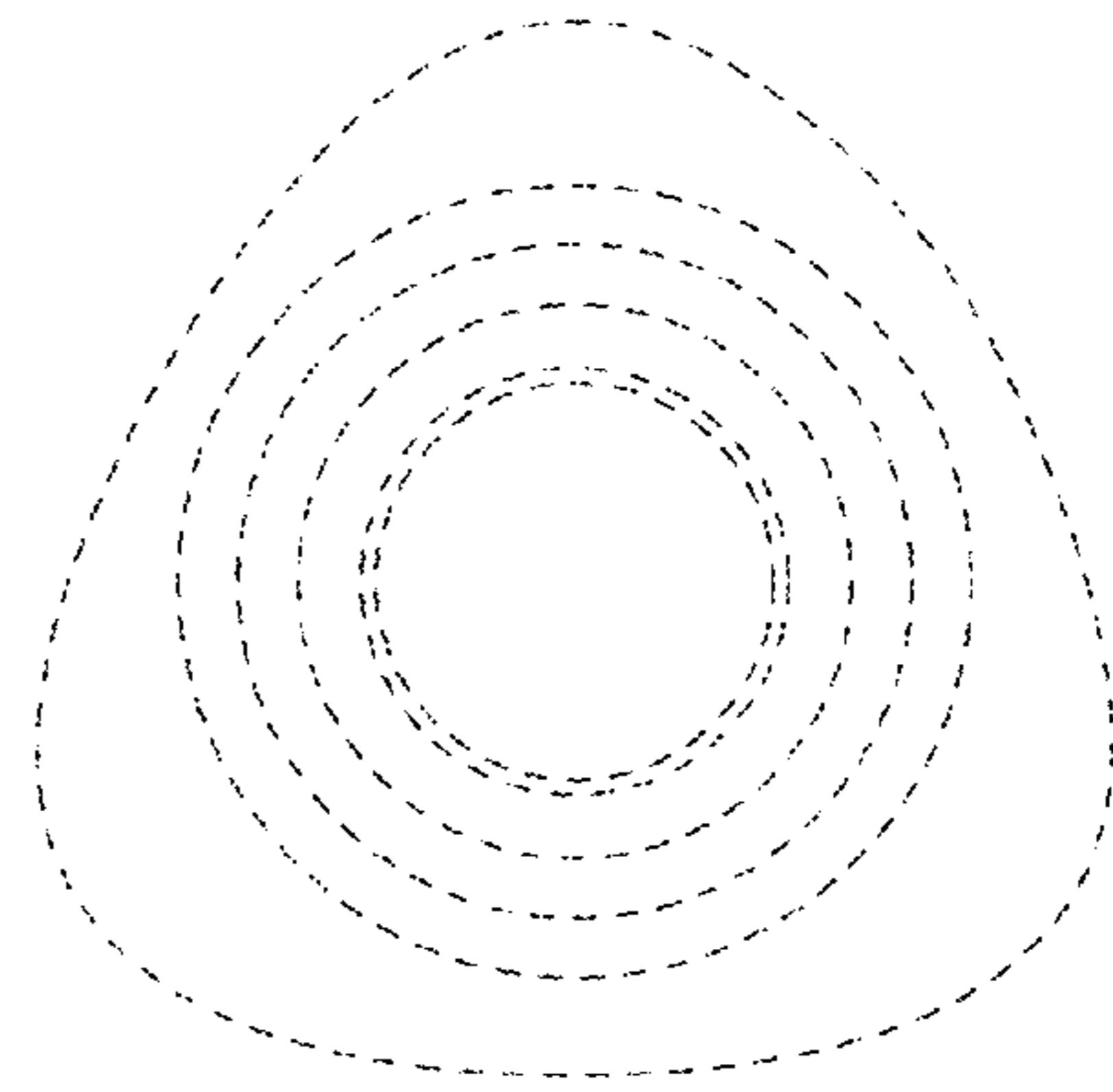

Fig. 34

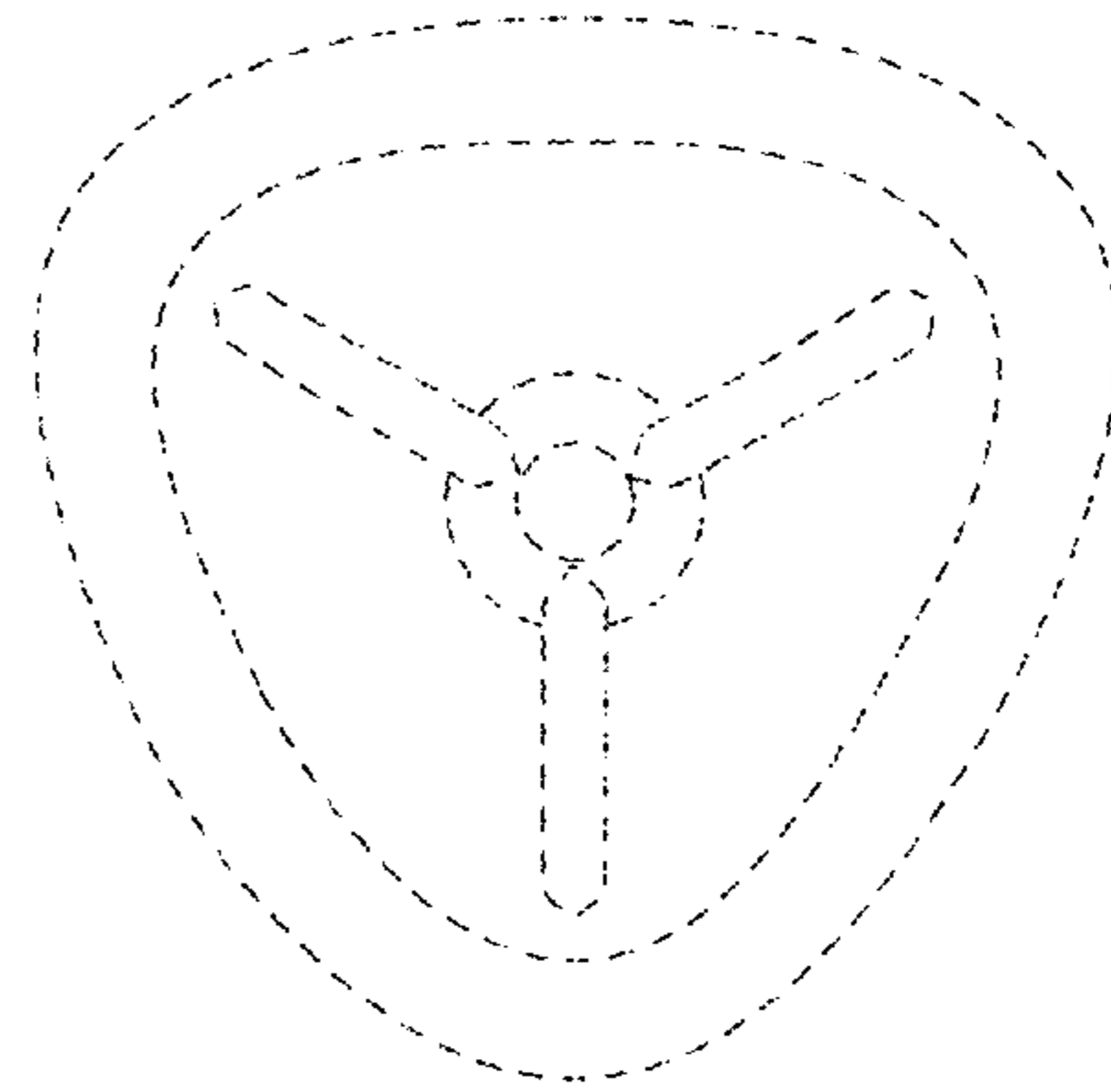

Fig. 35