

US00D703522S

(12) **United States Design Patent**
Kashimura

(10) **Patent No.:** **US D703,522 S**

(45) **Date of Patent:** **** Apr. 29, 2014**

(54) **PRESS NUT**

(71) Applicant: **Newfrey LLC**, Newark, DE (US)

(72) Inventor: **Shuji Kashimura**, Toyohashi (JP)

(73) Assignee: **Newfrey LLC**, Newark, DE (US)

(**) Term: **14 Years**

(21) Appl. No.: **29/436,546**

(22) Filed: **Nov. 7, 2012**

Related U.S. Application Data

(63) Continuation-in-part of application No. 29/409,093, filed on Dec. 20, 2011.

Foreign Application Priority Data

Jun. 21, 2011 (JP) 2011-14055

(51) **LOC (10) Cl.** **08-08**

(52) **U.S. Cl.**

USPC **D8/397**

(58) **Field of Classification Search**

USPC D8/397, 394, 382, 349, 356, 399, 363,
D8/352; 403/291, 309, 300, 301, 310, 311,
403/403; 411/427, 429, 432, 918, 180

See application file for complete search history.

(56) **References Cited**

U.S. PATENT DOCUMENTS

D32,659 S * 5/1900 Ernest D8/397
D32,793 S * 6/1900 Fauber D8/399
687,774 A * 12/1901 Oliver 411/326
D57,407 S * 3/1921 Walker D23/269

2,764,886 A * 10/1956 Wiesmann 52/105
3,213,914 A * 10/1965 Baumle et al. 411/179
D218,674 S * 9/1970 Ernest D8/387
D278,594 S * 4/1985 Lye D8/25
5,092,725 A * 3/1992 Aittama 411/190
D364,882 S * 12/1995 Junkers D15/199
5,622,208 A * 4/1997 Vinson 138/89
D453,000 S * 1/2002 Shinjo et al. D8/397
D520,856 S * 5/2006 Osiecki et al. D8/312
D520,859 S * 5/2006 Osiecki et al. D8/321
D549,091 S * 8/2007 McIntyre et al. D8/399
D557,132 S * 12/2007 Shinjo D8/397
D690,581 S * 10/2013 Brander D8/349
2008/0206013 A1 8/2008 Bentrin

* cited by examiner

Primary Examiner — Cynthia Underwood

(74) *Attorney, Agent, or Firm* — Michael P. Leary

(57) **CLAIM**

The ornamental design for a press nut, as shown and described.

DESCRIPTION

FIG. 1 is a front view of a press nut according to the present invention, the rear view, right side and left side being identical images thereof;

FIG. 2 is a top view thereof;

FIG. 3 is a bottom view thereof;

FIG. 4 is an enlarged view cut-away taken along line 4-4 of FIG. 1;

FIG. 5 is a cross-sectional view taken along line 5-5 of FIG. 2; and,

FIG. 6 is a cross-sectional view, shown reduced in scale, taken along line 6-6 of FIG. 2, showing the item in its environment of use, the broken lines forming no part of the claim.

1 Claim, 5 Drawing Sheets

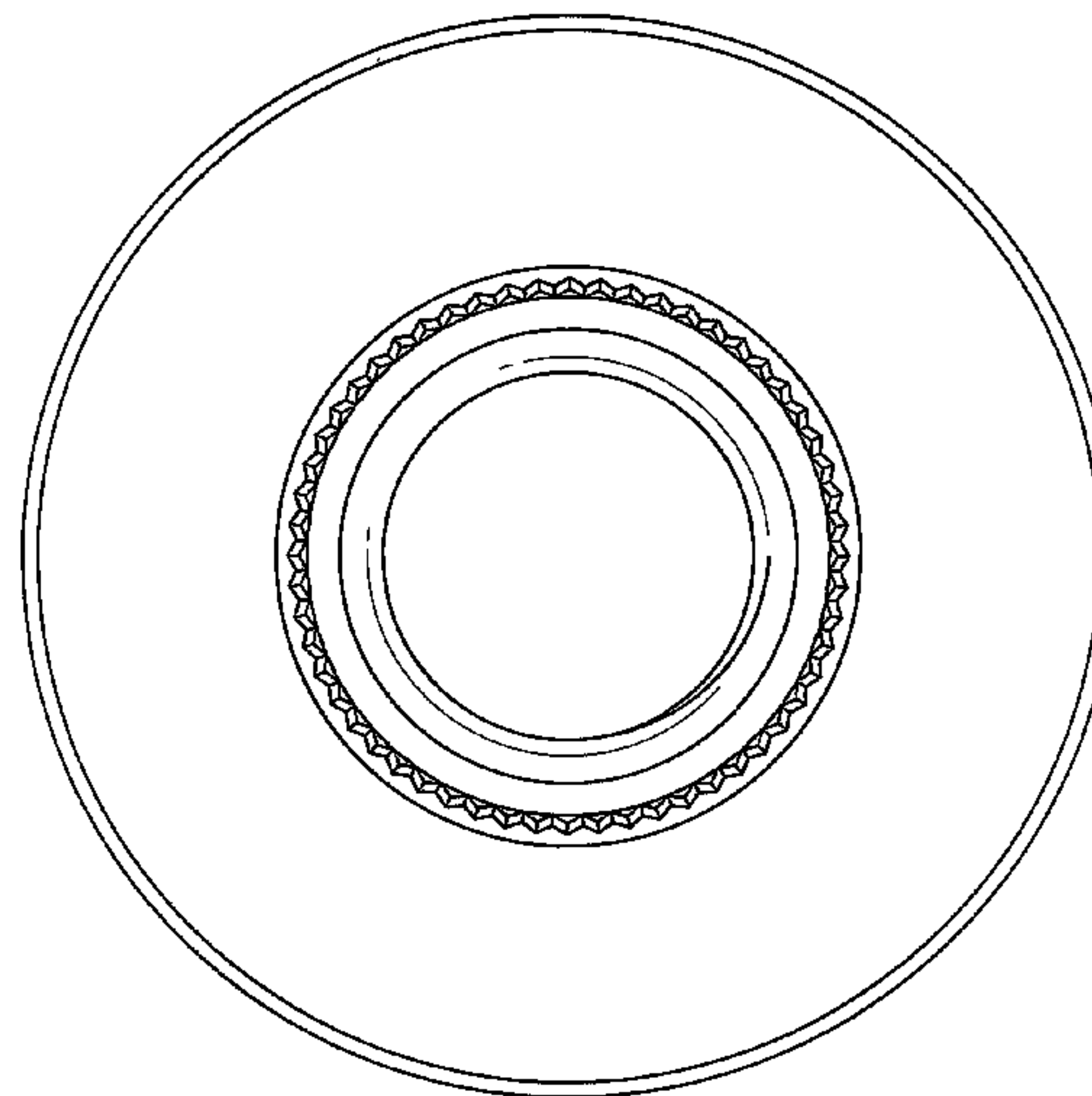
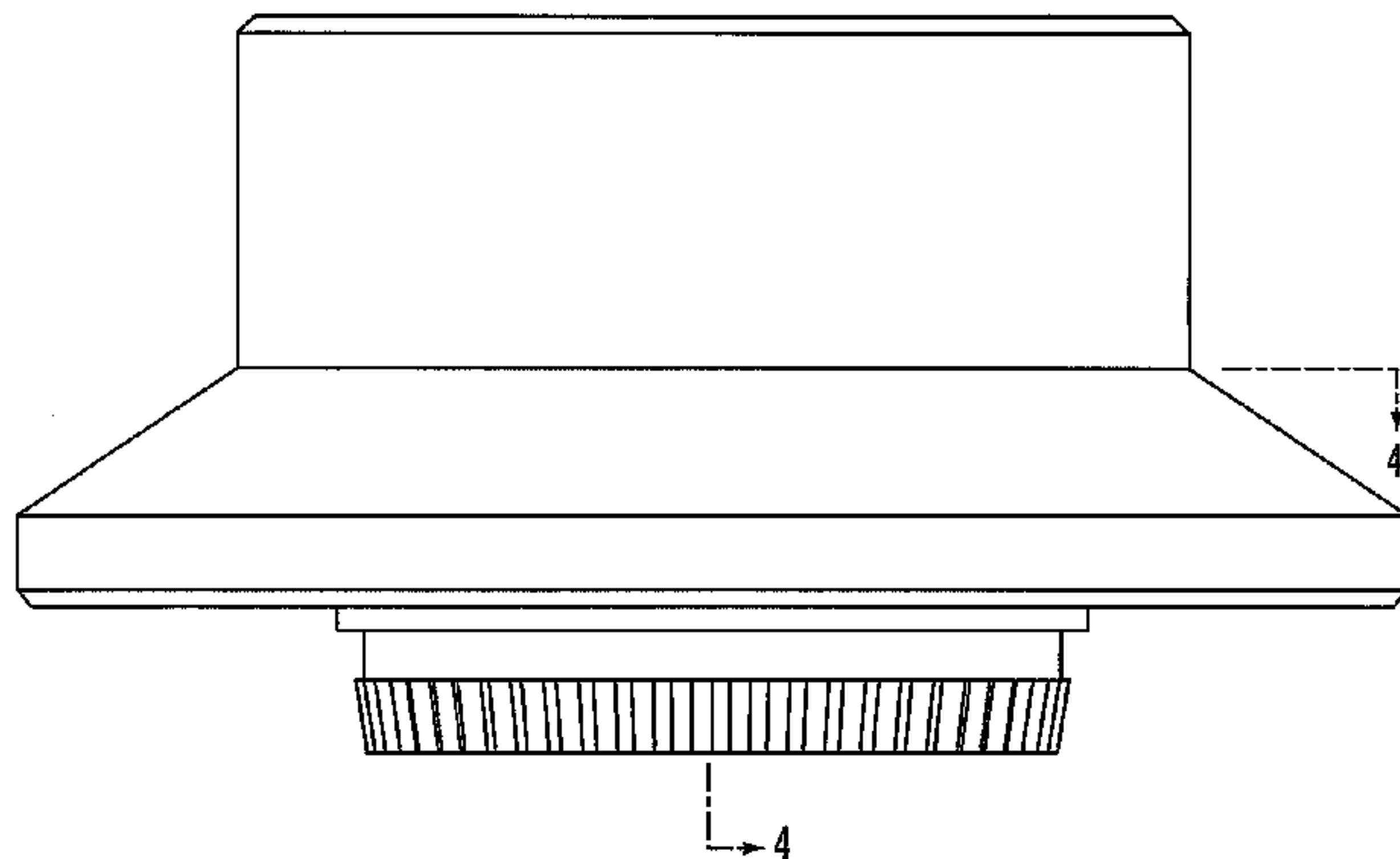

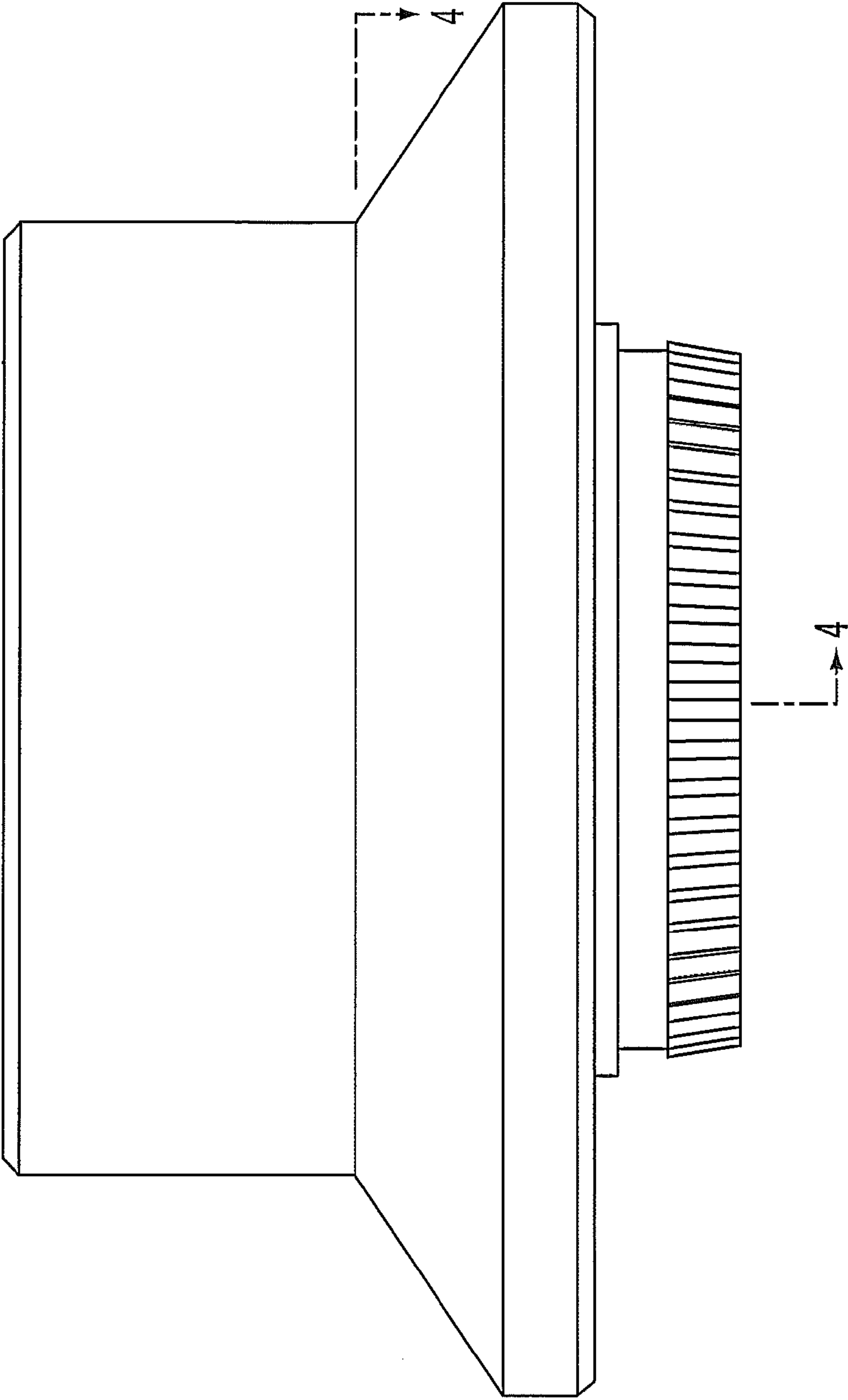

FIG. 1

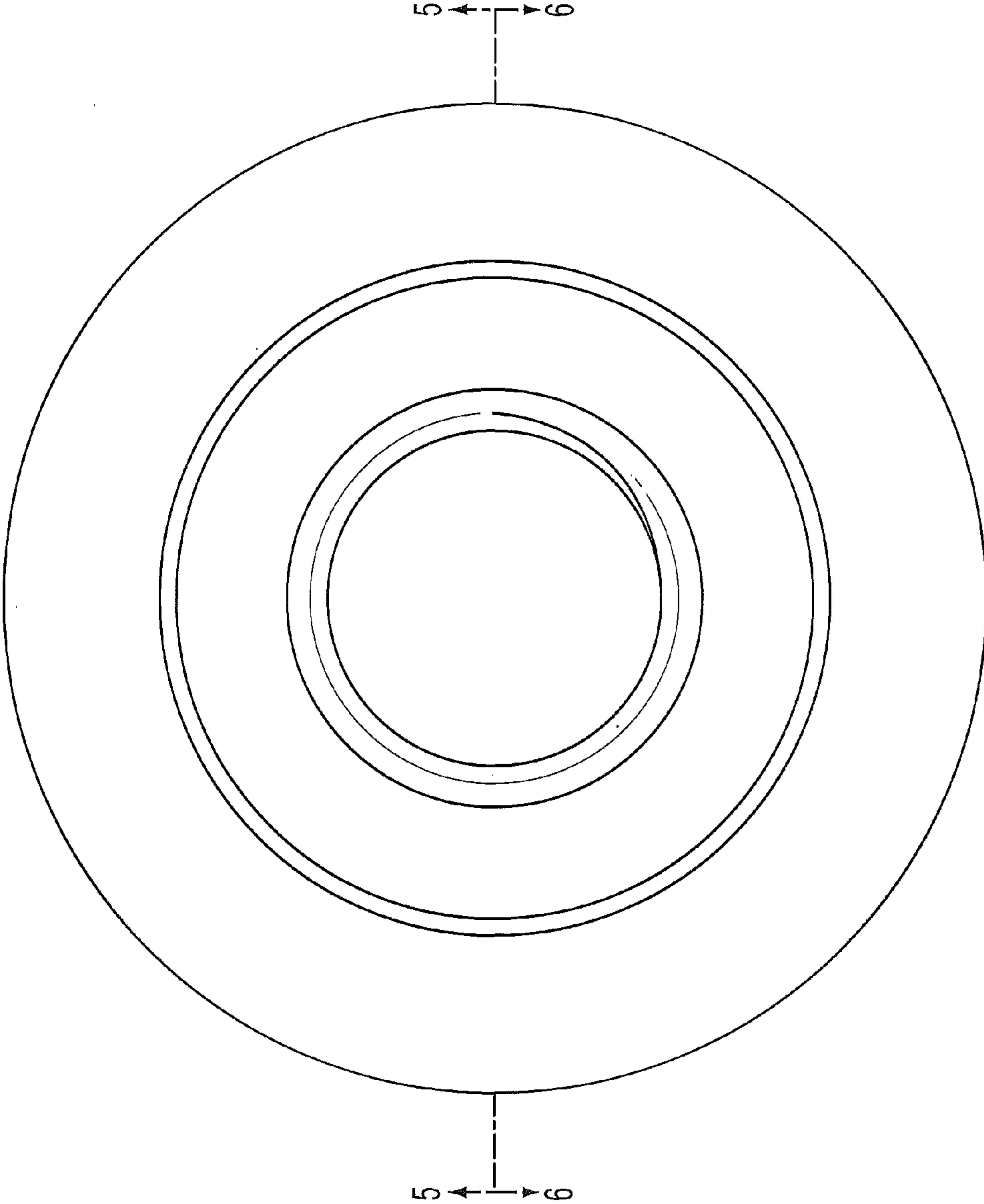

FIG. 2

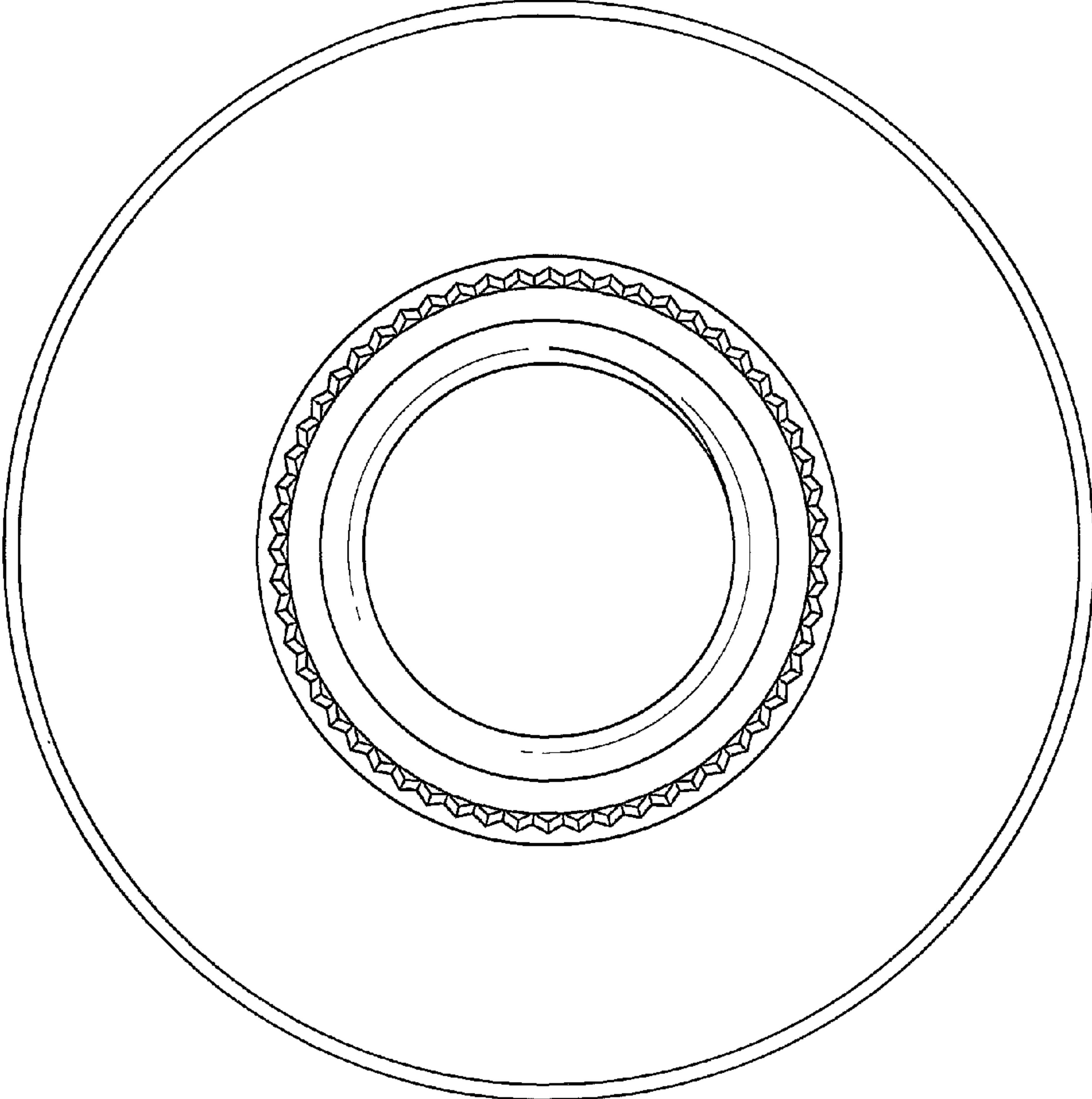
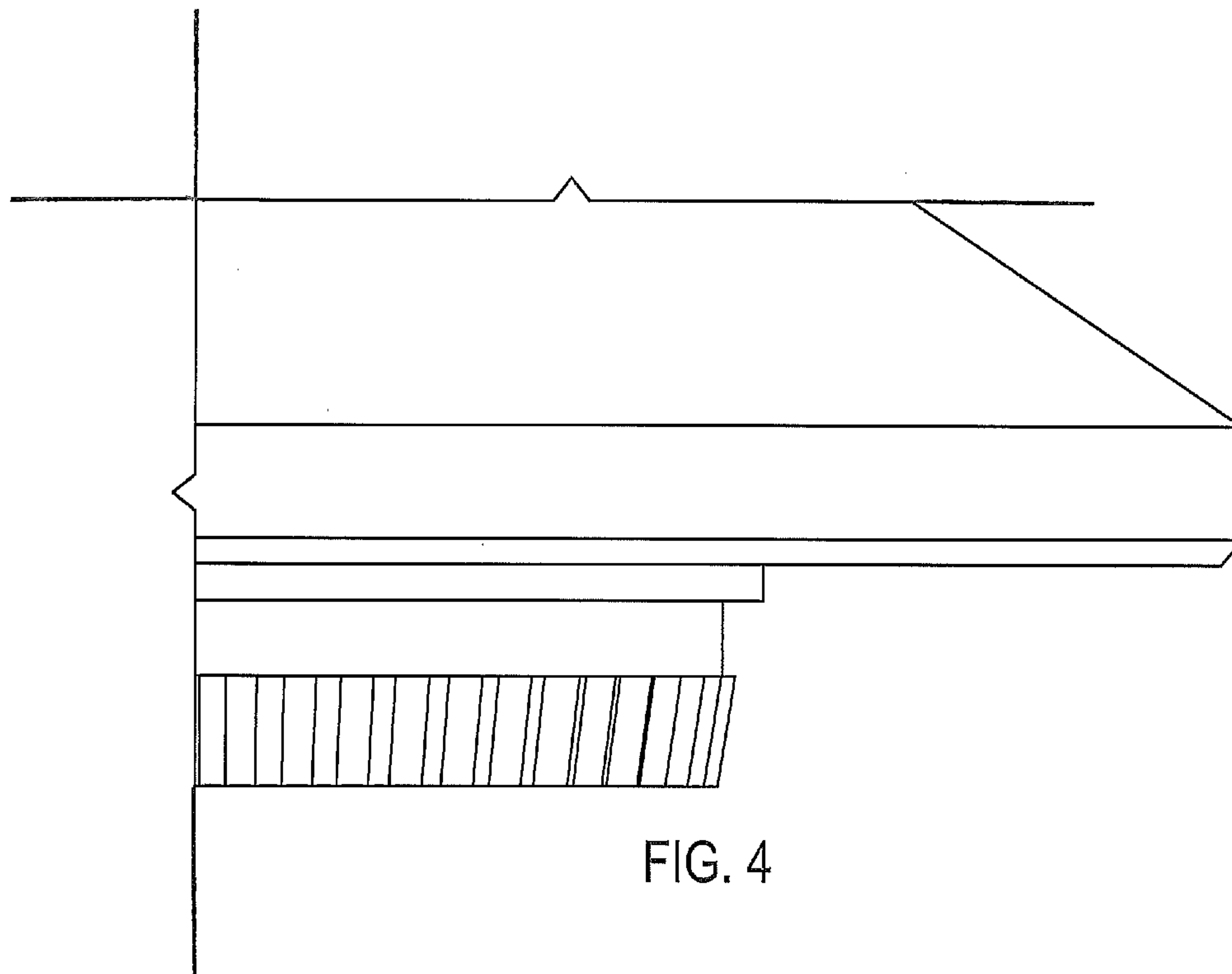

FIG. 3



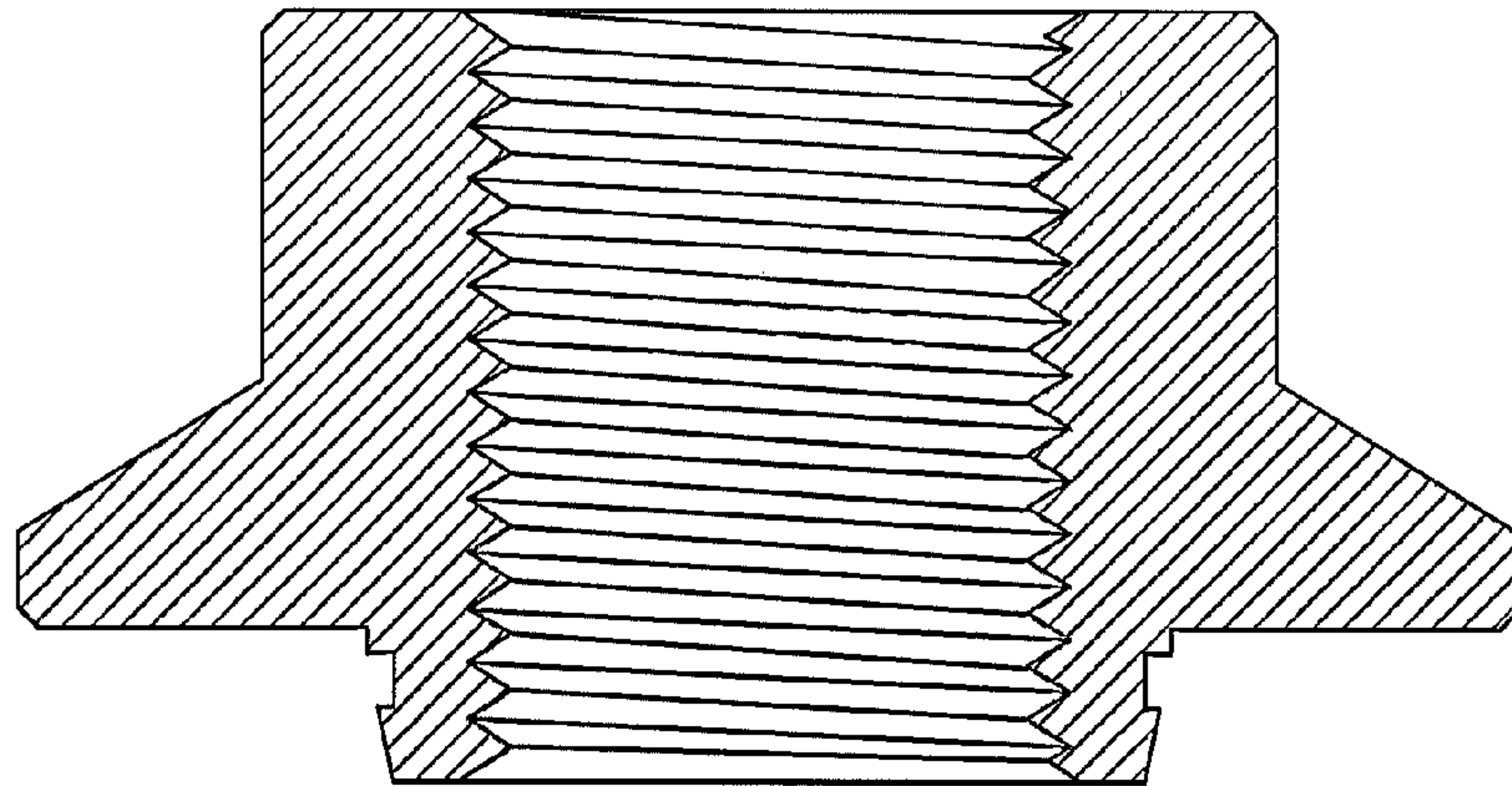

FIG. 5

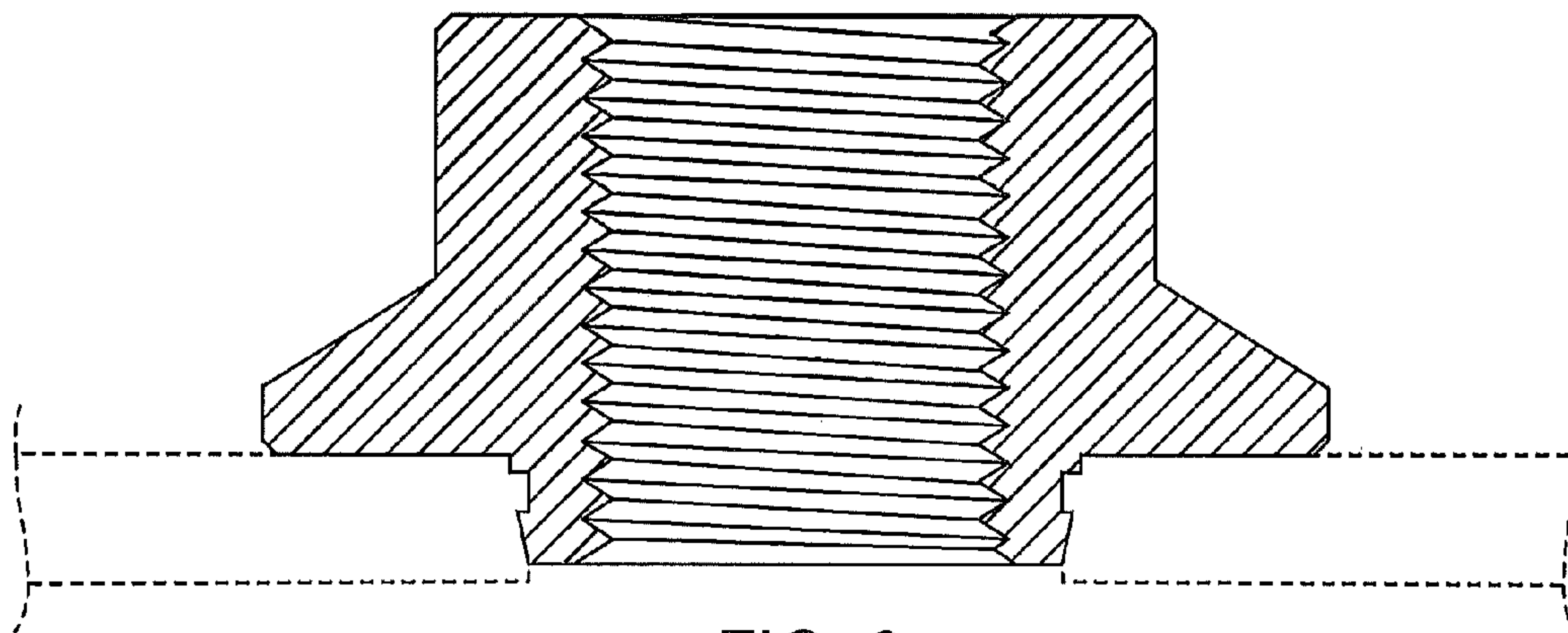

FIG. 6