



US00D703506S

(12) **United States Design Patent**
Steiner et al.

(10) **Patent No.:** **US D703,506 S**
(45) **Date of Patent:** **** Apr. 29, 2014**

(54) **CABLE PREPARATION TOOL**

(75) Inventors: **Richard A. Steiner**, East Haddam, CT (US); **Charles Gargano**, Guilford, CT (US)

(73) Assignee: **Rostra Tool Company**, Branford, CT (US)

(**) Term: **14 Years**

(21) Appl. No.: **29/405,776**

(22) Filed: **Nov. 7, 2011**

(51) **LOC (10) Cl.** **08-05**

(52) **U.S. Cl.**
USPC **D8/51**

(58) **Field of Classification Search**
USPC D8/51; 156/367, 368; 29/751, 750, 752, 29/747; 30/90.7, 250, 90.1, 90.6, 91.2, 30/287, 293; 81/9.44, 423; 211/71.01, 211/85.19; 248/146; D34/6
See application file for complete search history.

(56) **References Cited**

U.S. PATENT DOCUMENTS

4,059,893	A *	11/1977	Solury	30/90.1
4,130,031	A	12/1978	Wiener et al.		
5,826,338	A *	10/1998	Chilton et al.	30/90.1
6,128,976	A	10/2000	Tarpill		
6,253,641	B1	7/2001	Tarpill		
6,282,995	B1 *	9/2001	Lin	81/423
6,526,661	B1 *	3/2003	Shutts et al.	30/90.1
6,964,288	B2	11/2005	Christopher et al.		
7,216,431	B2	5/2007	Holliday et al.		
7,318,272	B1	1/2008	Steiner		
D693,198	S *	11/2013	Hutchfield et al.	D8/51
2013/0111763	A1 *	5/2013	Steiner et al.	30/91.2

* cited by examiner

Primary Examiner — Robert M Spear

Assistant Examiner — Eliza Bennett-Hattan

(74) *Attorney, Agent, or Firm* — Cantor Colburn LLP

(57) **CLAIM**

We claim, the ornamental design for a cable preparation tool, as shown and described.

DESCRIPTION

FIG. 1 is a first perspective view of an exemplary embodiment of the invention;

FIG. 2 is a top view of the exemplary embodiment of FIG. 1;

FIG. 3 is a bottom view of the exemplary embodiment of FIG. 1;

FIG. 4 is a first side view of the exemplary embodiment of FIG. 1;

FIG. 5 is a second side view of the exemplary embodiment of FIG. 1;

FIG. 6 is a first end view of the exemplary embodiment of FIG. 1;

FIG. 7 is a second end view of the exemplary embodiment of FIG. 1;

FIG. 8 is front perspective view of another embodiment of the invention;

FIG. 9 is a top view of the embodiment of the embodiment of FIG. 8;

FIG. 10 is a bottom view of the embodiment of FIG. 8;

FIG. 11 is a first side view of the embodiment of FIG. 8;

FIG. 12 is a second side view of the embodiment of FIG. 8;

FIG. 13 is a first end view of the embodiment of FIG. 8; and,

FIG. 14 is a second end view of the embodiment of FIG. 8.

The broken lines shown in FIG. 1-FIG. 8 are environmental and not part of the claimed design.

The color of the cable preparation tool forms no part of the claimed design, a cable preparation tool according to the claimed design may be of any color or combination of colors.

The surface treatment of the cable preparation tool forms no part of the claimed design, a cable preparation tool according to the claimed design may have any surface treatment.

References to “side”, “end”, “top”, and “bottom” in the figure descriptions are not meant to require certain in-use orientation, a cable preparation tool according to the claimed design may be used in any orientation.

1 Claim, 10 Drawing Sheets

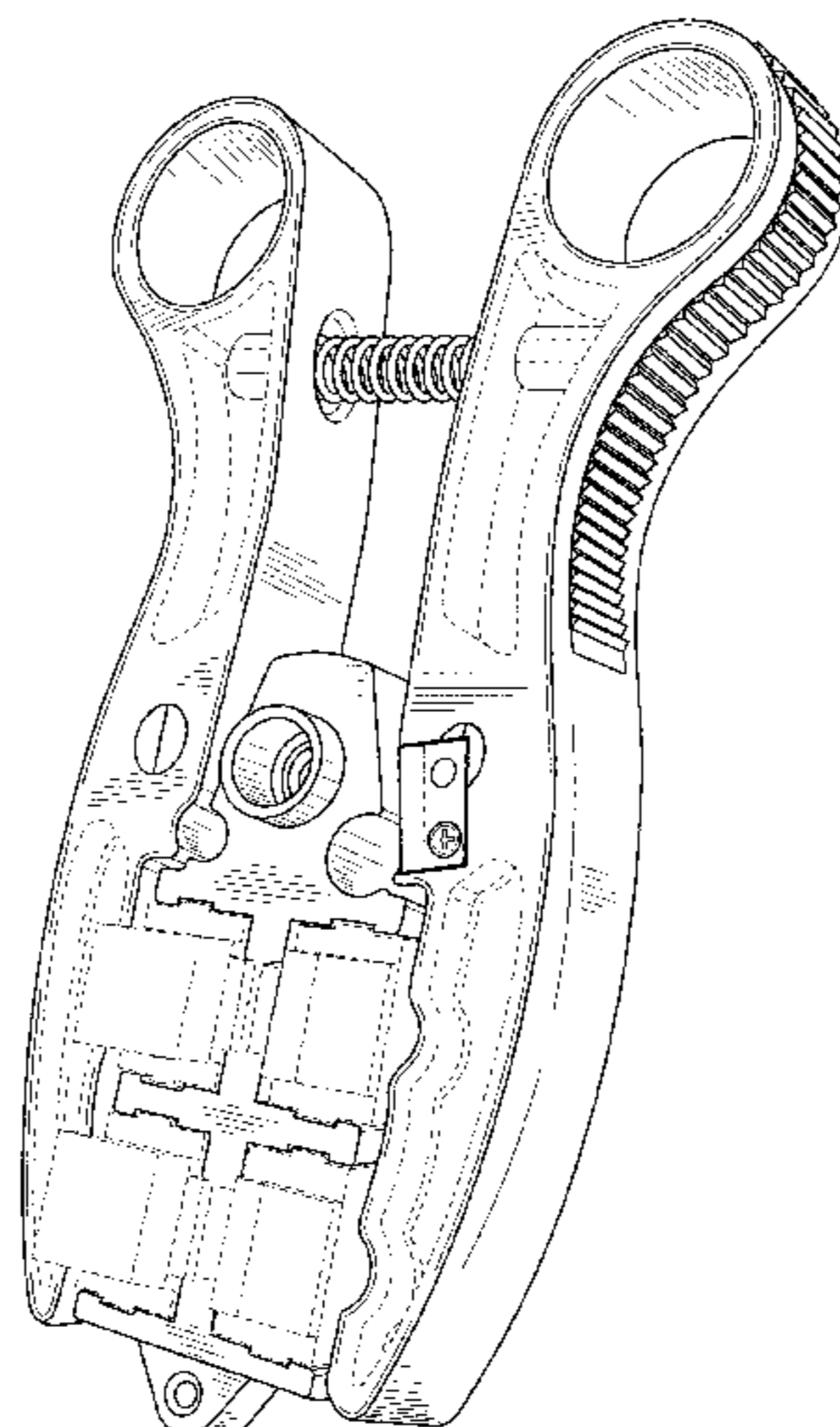

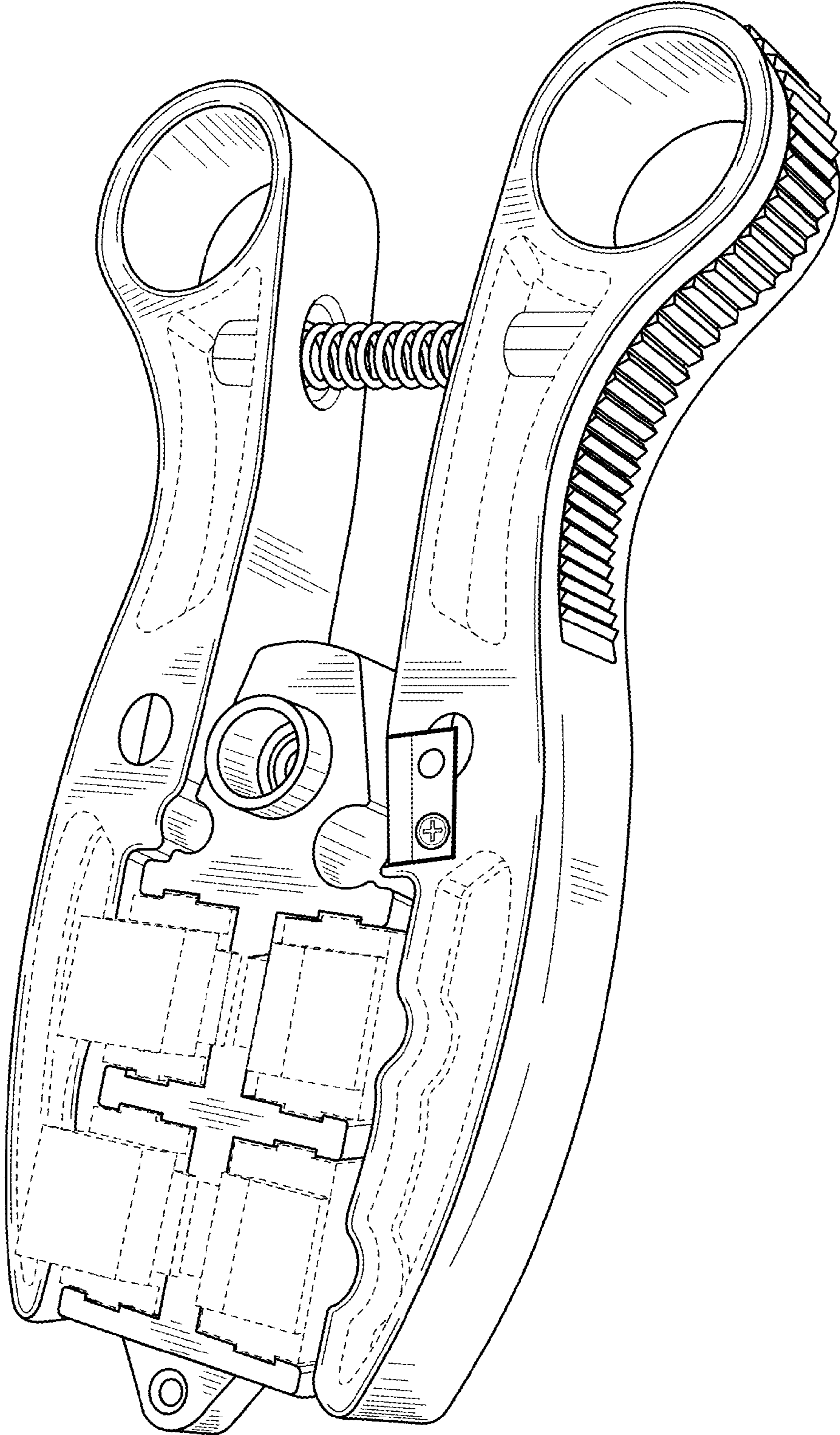

FIG. 1

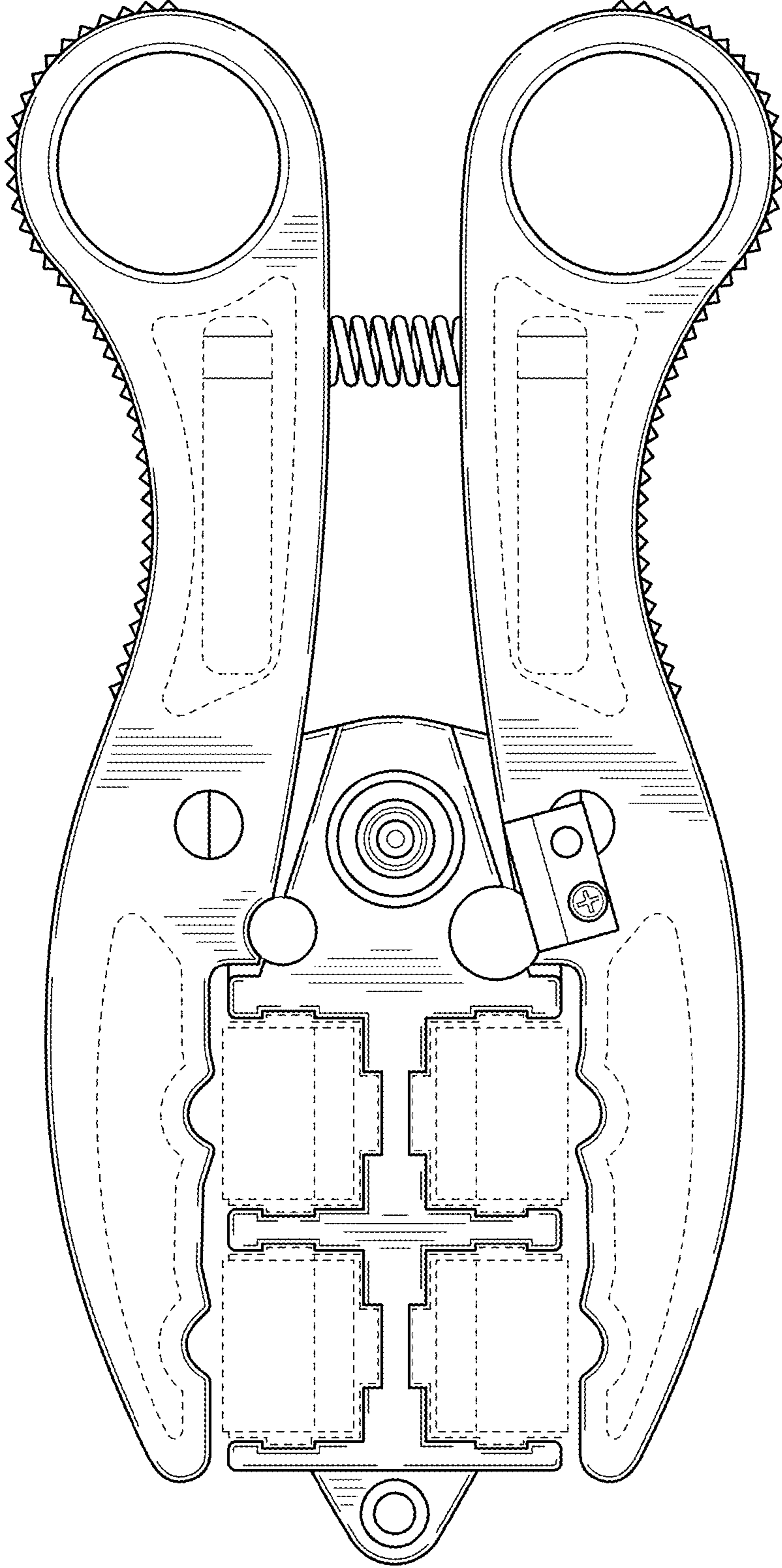

FIG. 2

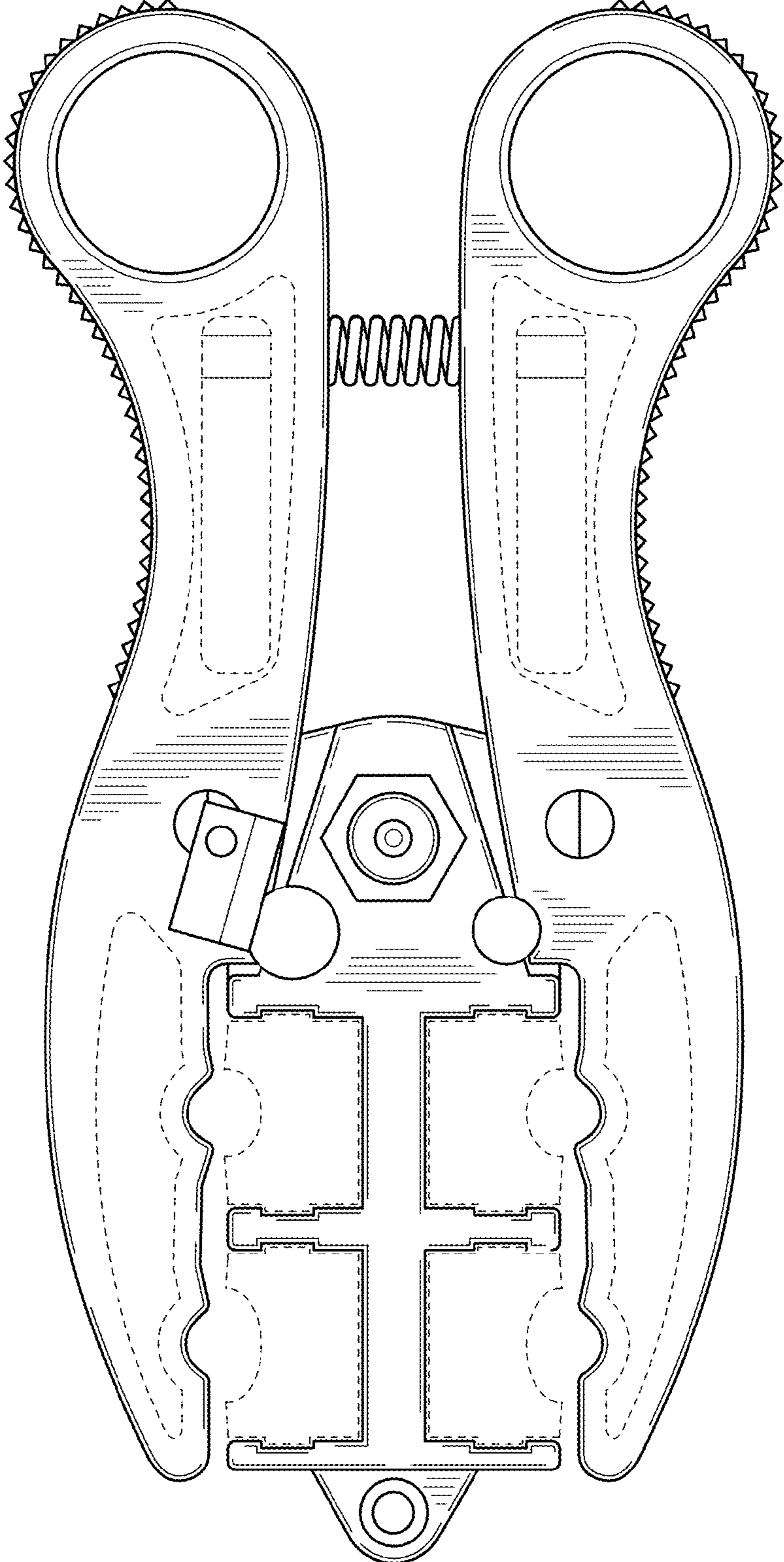

FIG. 3

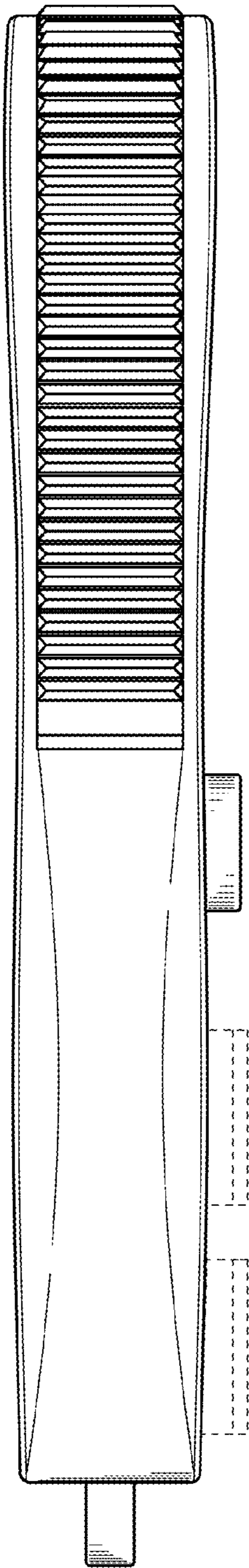

FIG. 4

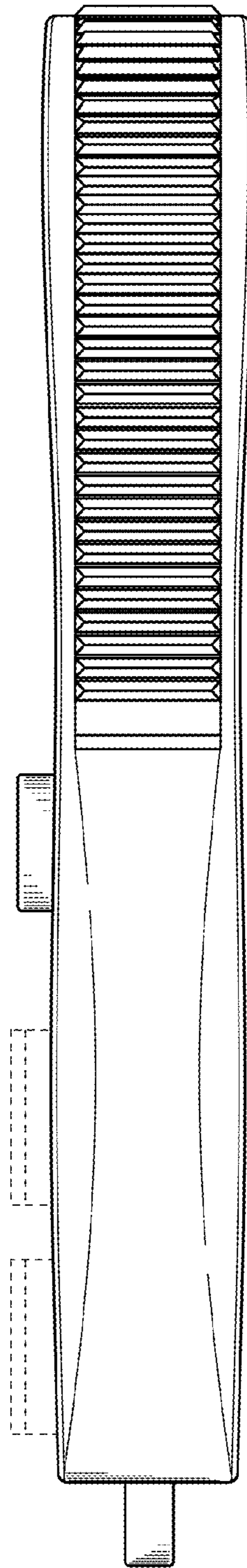

FIG. 5

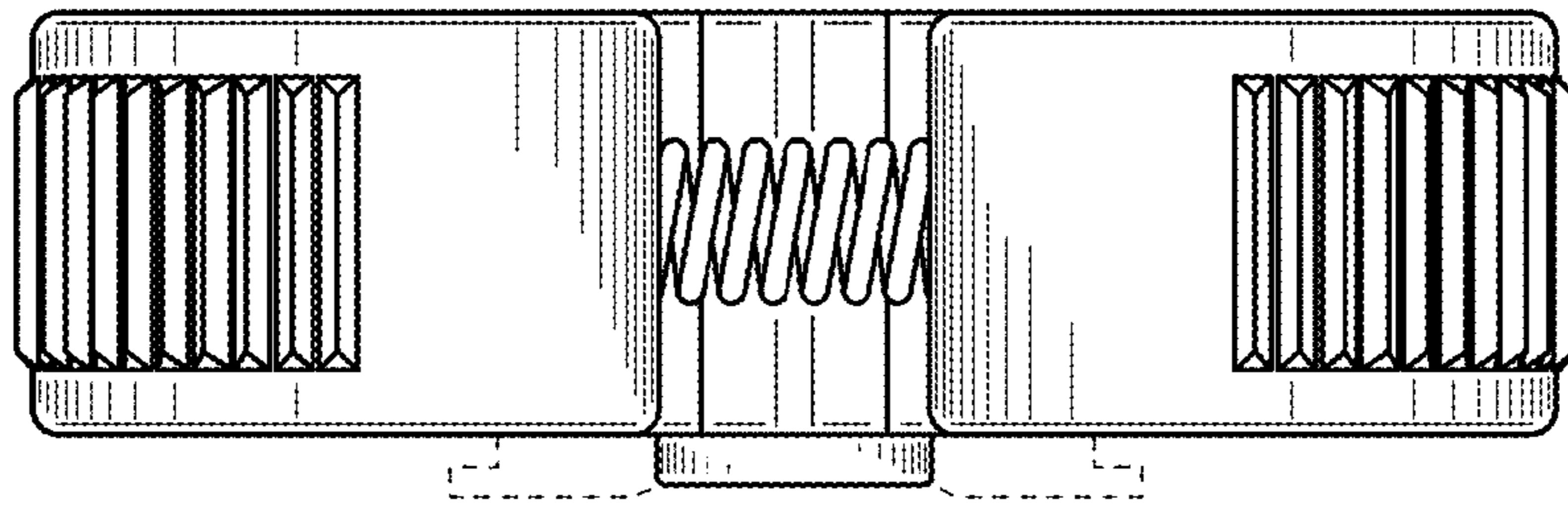

FIG. 6

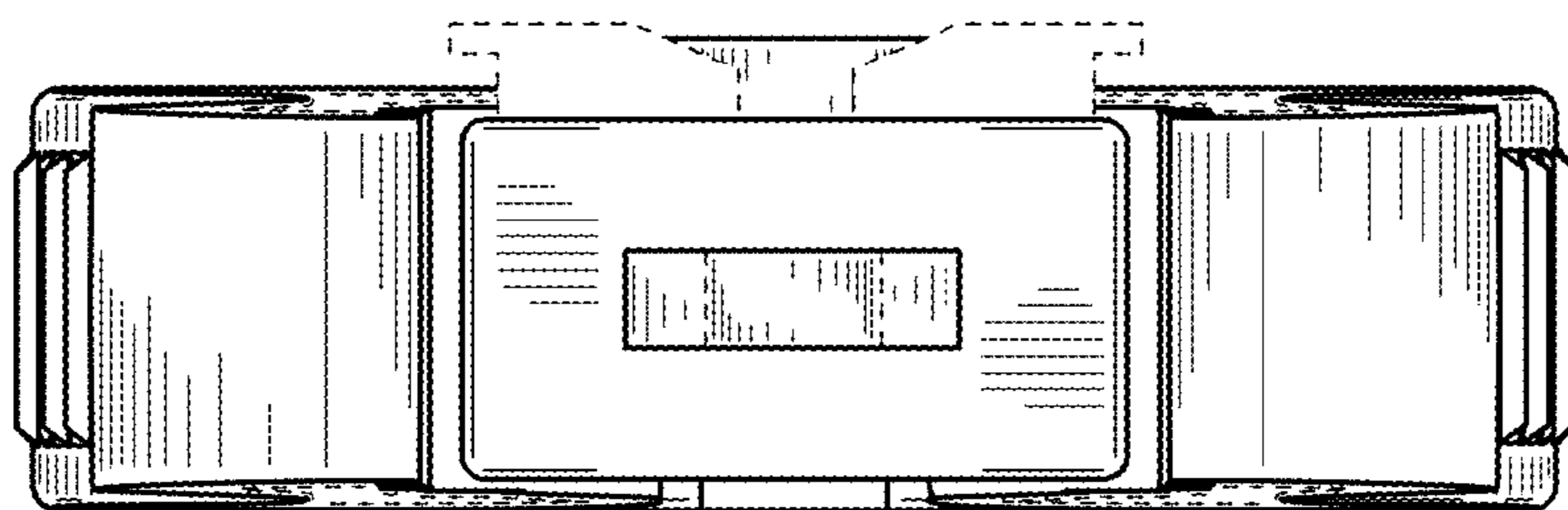

FIG. 7

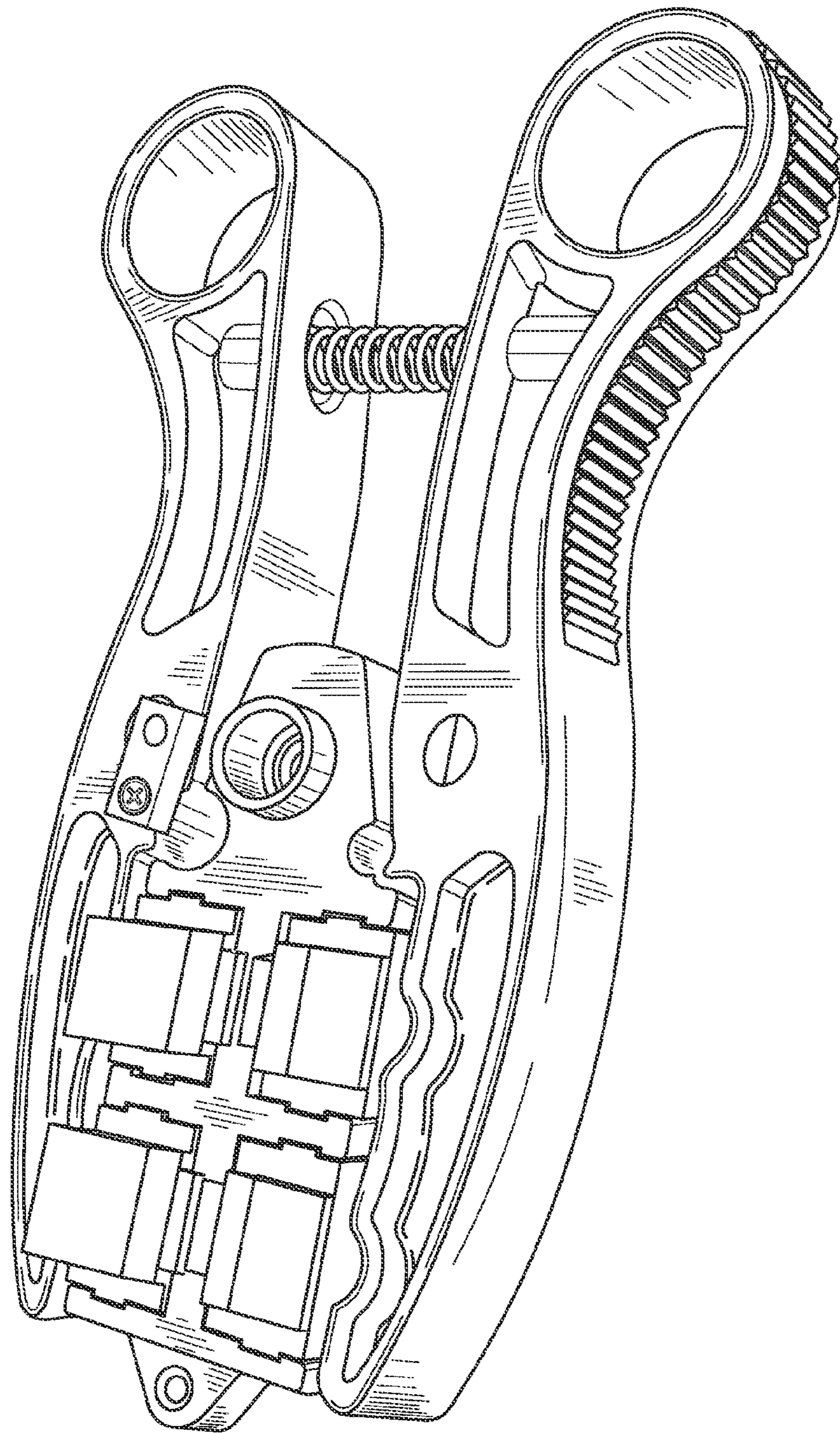

FIG. 8

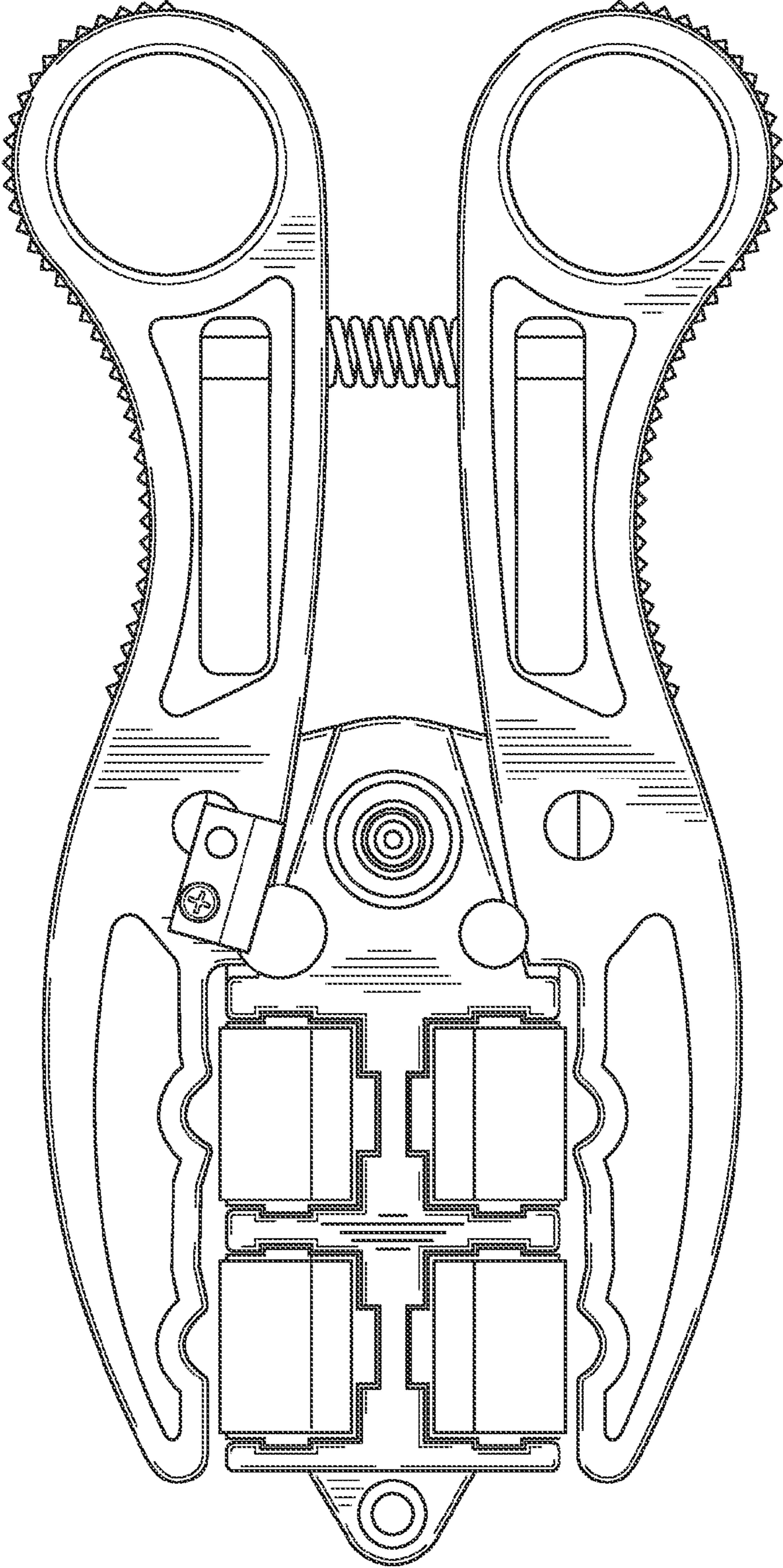

FIG. 9

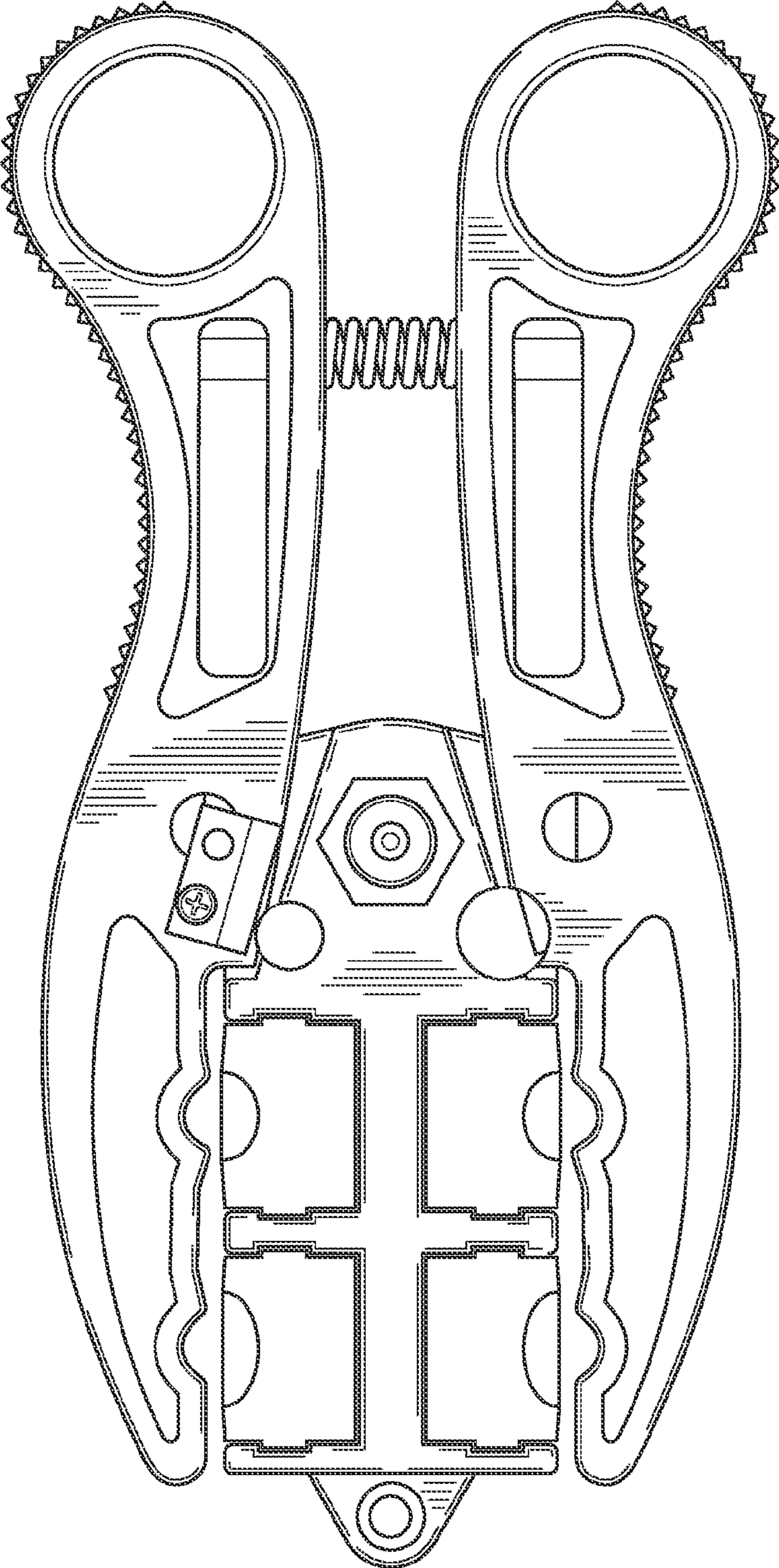

FIG. 10

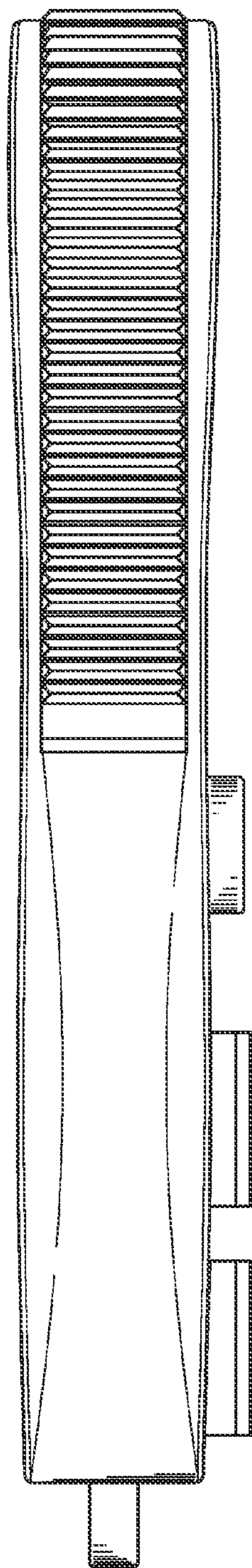

FIG. 11

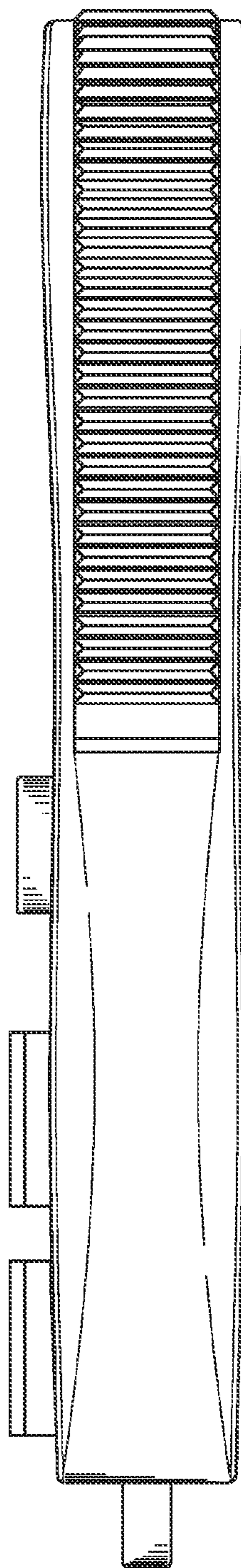

FIG. 12

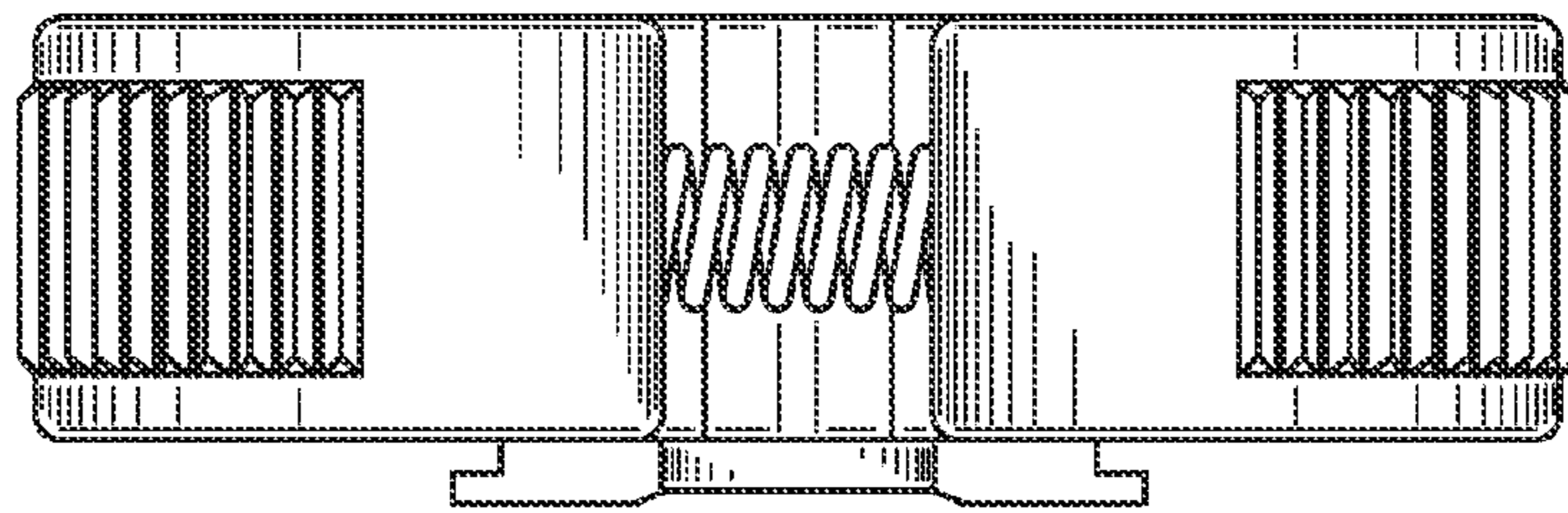

FIG. 13

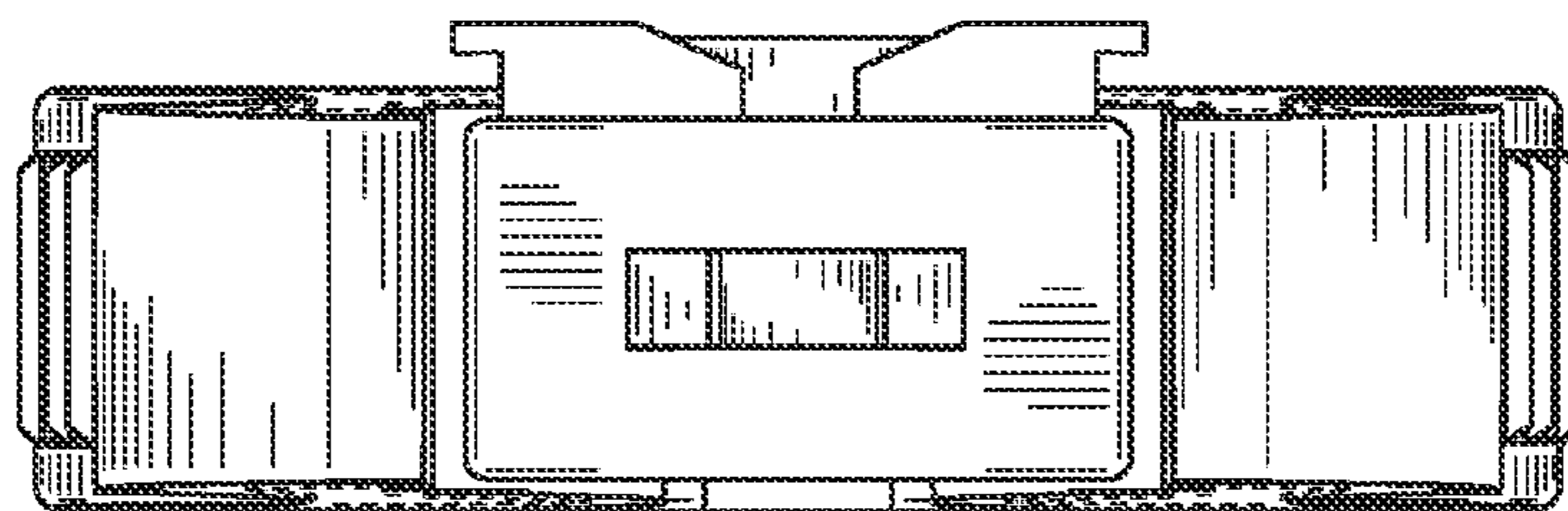

FIG. 14