



US00D703499S

(12) **United States Design Patent**  
**Jochim et al.**

(10) **Patent No.:** **US D703,499 S**  
(45) **Date of Patent:** **\*\* Apr. 29, 2014**

- (54) **SELF CLEANING RAKE**
- (71) Applicant: **Wright Innovations**, Houston, TX (US)
- (72) Inventors: **James David Jochim**, Houston, TX (US); **Christopher Scott Lovchik**, Webster, TX (US)
- (73) Assignee: **Wright Innovations**, Houston, TX (US)
- (\*\*) Term: **14 Years**
- (21) Appl. No.: **29/447,309**
- (22) Filed: **Mar. 1, 2013**
- (51) **LOC (10) Cl.** ..... **08-01**
- (52) **U.S. Cl.**  
USPC ..... **D8/13**
- (58) **Field of Classification Search**  
USPC ..... D8/1, 10, 13; 56/400.01, 400.04, 56/400.07, 400.16, 400.12, 400.17, 400.21  
See application file for complete search history.

(56) **References Cited**

**U.S. PATENT DOCUMENTS**

182,679	A	9/1876	Knowles	
567,129	A *	9/1896	Gibbs .....	56/400.01
972,031	A	10/1910	Spalding et al.	
1,254,041	A	1/1918	Hoel	
1,263,255	A *	4/1918	Kohler .....	56/400.16
1,786,770	A *	12/1930	Myers .....	56/400.06
1,871,084	A *	8/1932	Reiter .....	56/400.08
1,958,757	A	1/1933	Klinger	
2,023,778	A *	12/1935	Bishop .....	56/400.01
2,211,236	A *	8/1940	Kunzelman .....	56/400.2
2,545,001	A *	3/1951	Mattmann .....	56/400.08
2,669,086	A *	2/1954	Kairis .....	56/400.08
2,702,981	A *	3/1955	McReynolds .....	56/400.2
2,842,930	A *	7/1958	Pagley .....	56/400.08
3,901,010	A *	8/1975	Pajunen .....	56/400.08
4,078,368	A *	3/1978	Binder .....	56/400.01
4,165,598	A	8/1979	Kutsi	

(Continued)

*Primary Examiner* — Sheryl Lane  
(74) *Attorney, Agent, or Firm* — DLA Piper LLP (US)

(57) **CLAIM**  
The ornamental design for a self cleaning rake, as shown and described.

**DESCRIPTION**

FIG. 1 is a top perspective view of a self cleaning rake showing the new design.  
 FIG. 2 is a bottom perspective view thereof;  
 FIG. 3 is a top view thereof;  
 FIG. 4 is a bottom view thereof;  
 FIG. 5 is a front view thereof;  
 FIG. 6 is a back view thereof;  
 FIG. 7 is a side view thereof;  
 FIG. 8 is a an opposing side view thereof;  
 FIG. 9 is a top perspective view of an embodiment of a self cleaning rake having a different cleaning element configuration, showing the new design;  
 FIG. 10 is a bottom perspective view thereof.  
 FIG. 11 is a top view thereof;  
 FIG. 12 is a bottom view thereof;  
 FIG. 13 is a front view thereof;  
 FIG. 14 is a back view thereof;  
 FIG. 15 is a side view thereof;  
 FIG. 16 is a an opposing side view thereof;  
 FIG. 17 is a top perspective view of an embodiment of a self cleaning rake having yet another cleaning element configuration, showing the new design;  
 FIG. 18 is a bottom perspective view thereof;  
 FIG. 19 is a top view thereof;  
 FIG. 20 is a bottom view thereof;  
 FIG. 21 is a front view thereof;  
 FIG. 22 is a back view thereof;  
 FIG. 23 is a side view thereof; and,  
 FIG. 24 is a an opposing side view thereof.  
 Portions of the article shown in broken lines form no part of the claimed design.

**1 Claim, 12 Drawing Sheets**

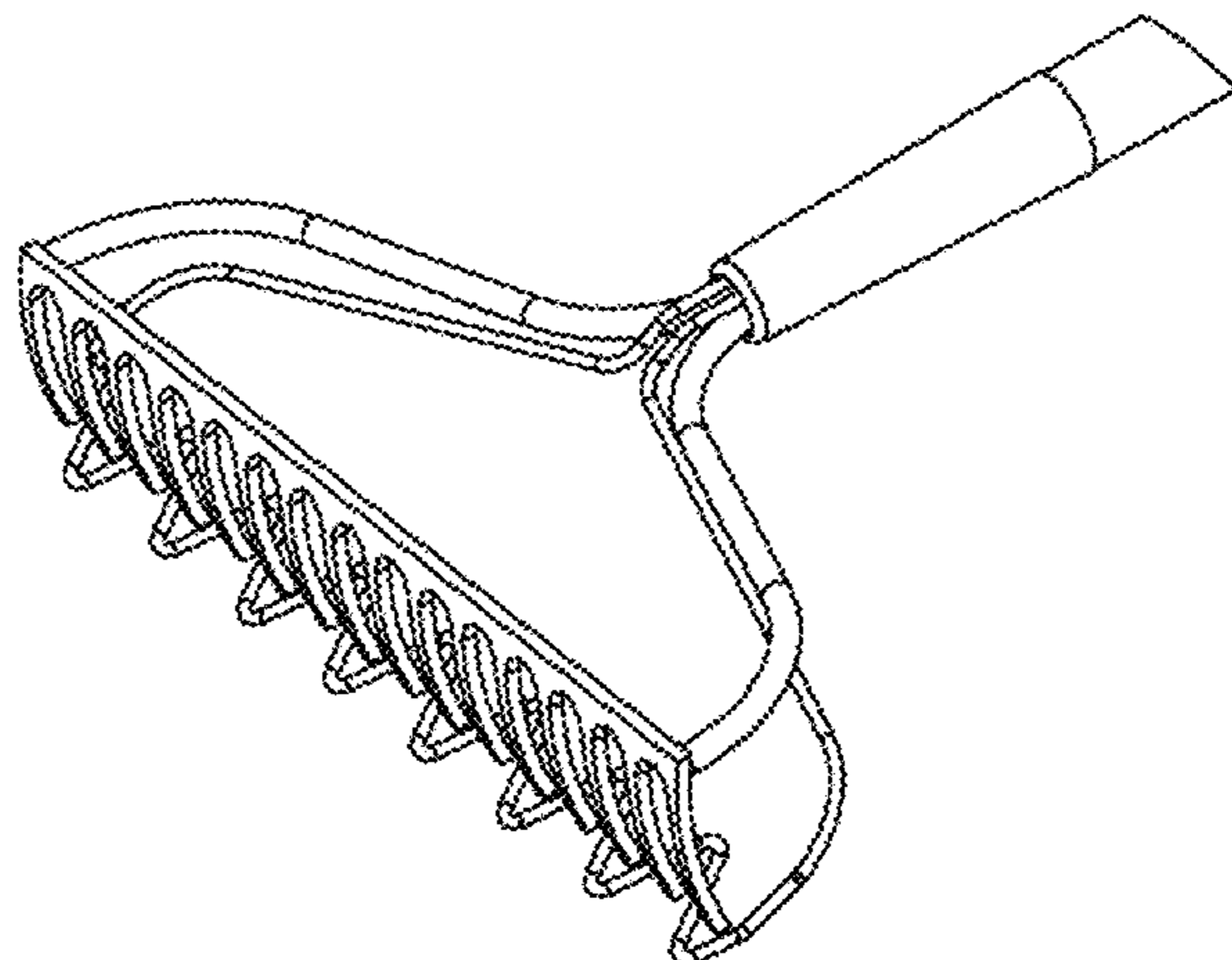
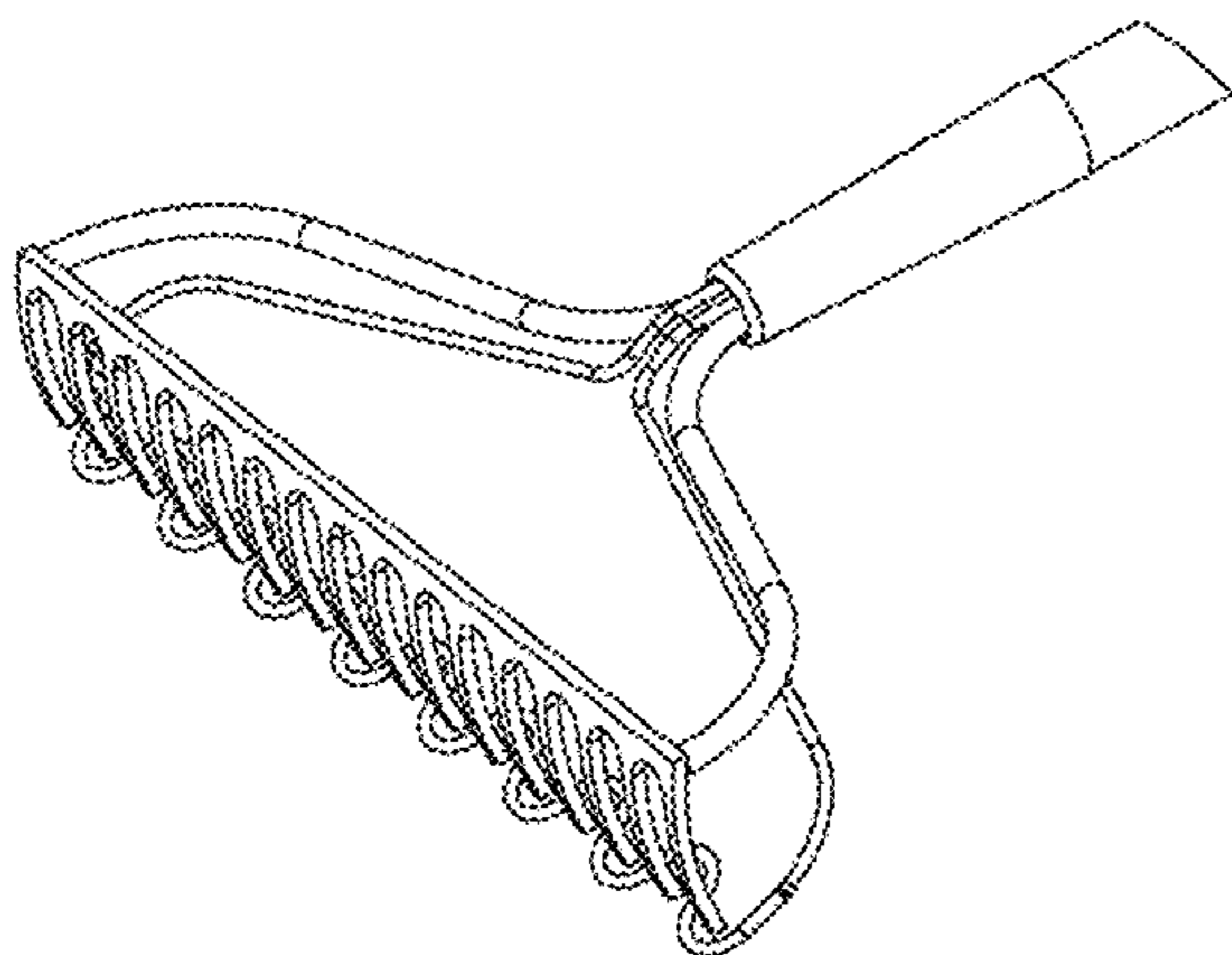

(56)

**References Cited**

U.S. PATENT DOCUMENTS

4,776,158 A 10/1988 Baum  
D306,682 S \* 3/1990 Thompson ..... D8/13  
D352,874 S \* 11/1994 Garcia ..... D8/13  
5,501,069 A 3/1996 Lentz  
D385,161 S \* 10/1997 Grinde ..... D8/13

5,713,193 A 2/1998 Stapley et al.  
D413,234 S \* 8/1999 Spear ..... D8/13  
D477,195 S \* 7/2003 Stojanovich ..... D8/13  
D508,639 S \* 8/2005 Long ..... D8/13  
D510,003 S \* 9/2005 Moore ..... D8/13  
D592,023 S \* 5/2009 Herrle ..... D8/13  
D640,103 S \* 6/2011 Paolini ..... D8/13  
2005/0188670 A1 9/2005 Dalfors

\* cited by examiner

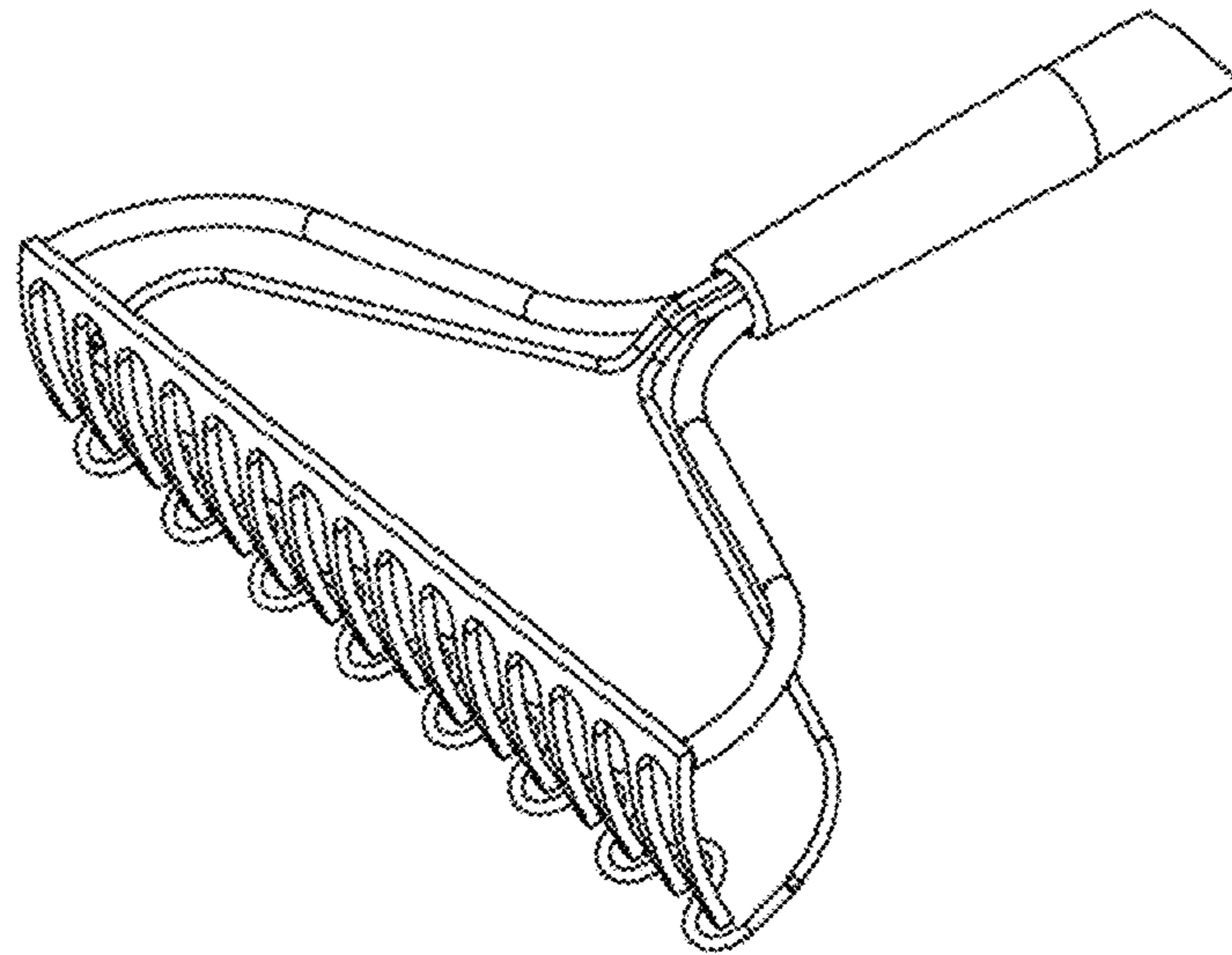

Figure 1

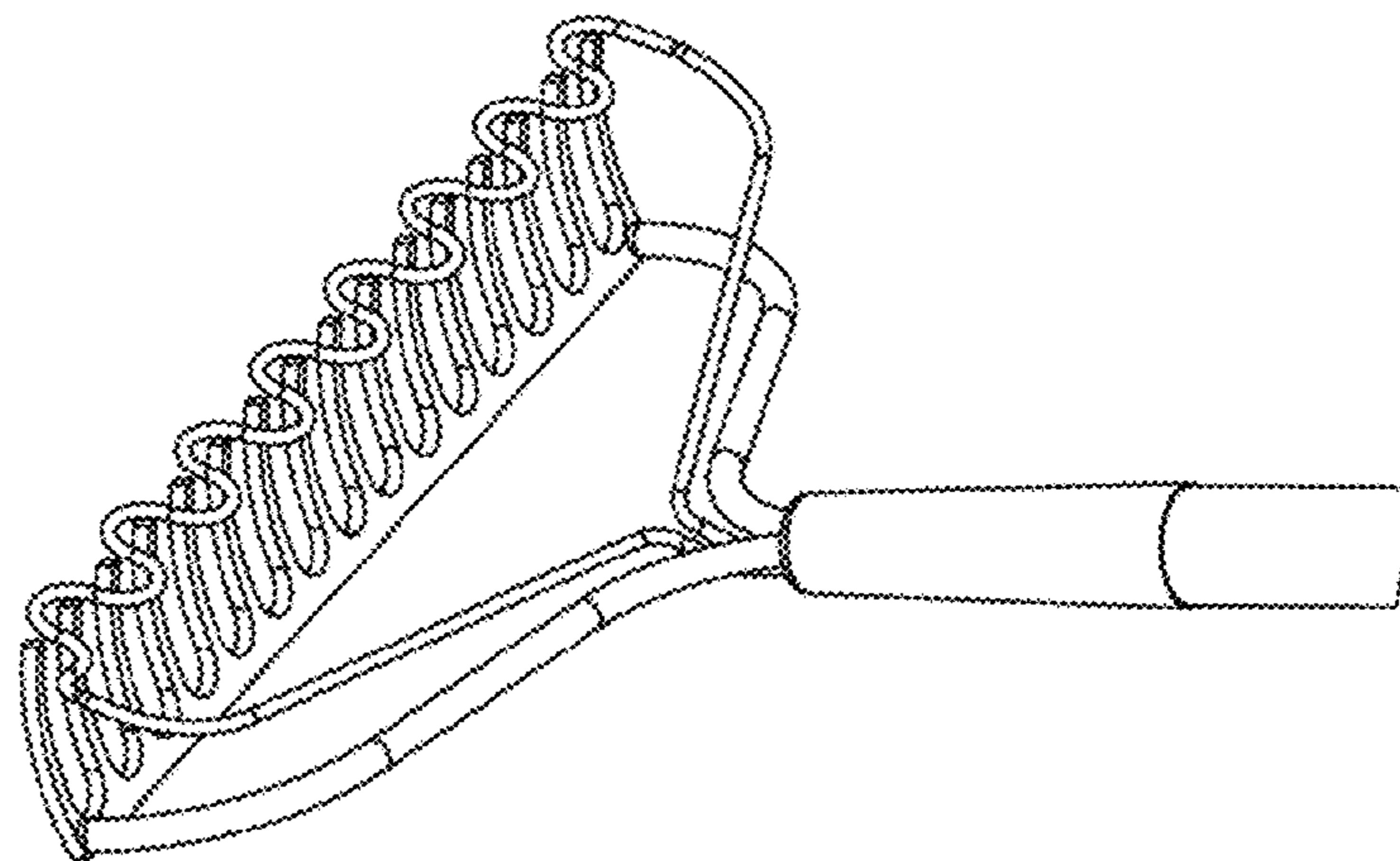

Figure 2

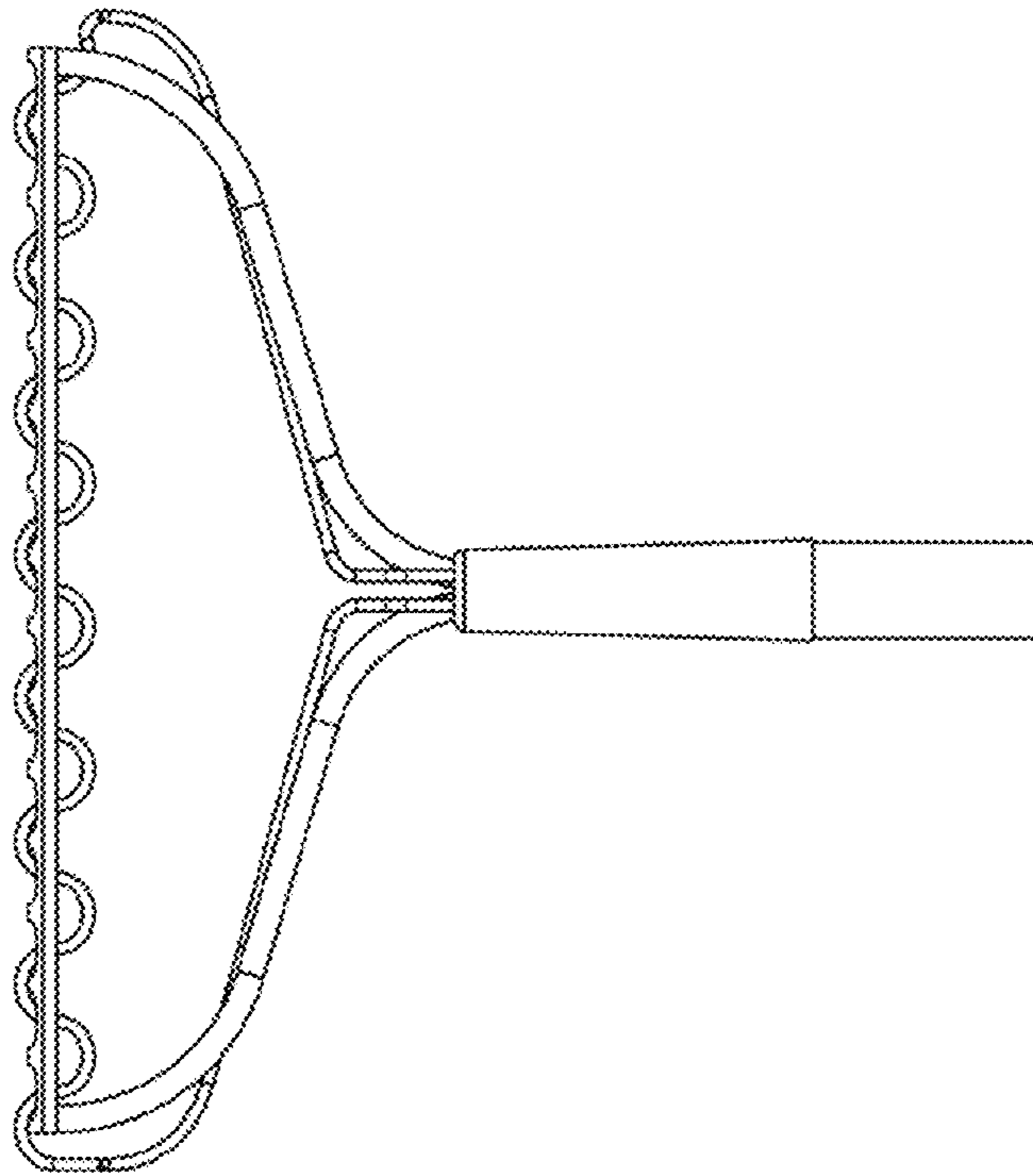

Figure 3

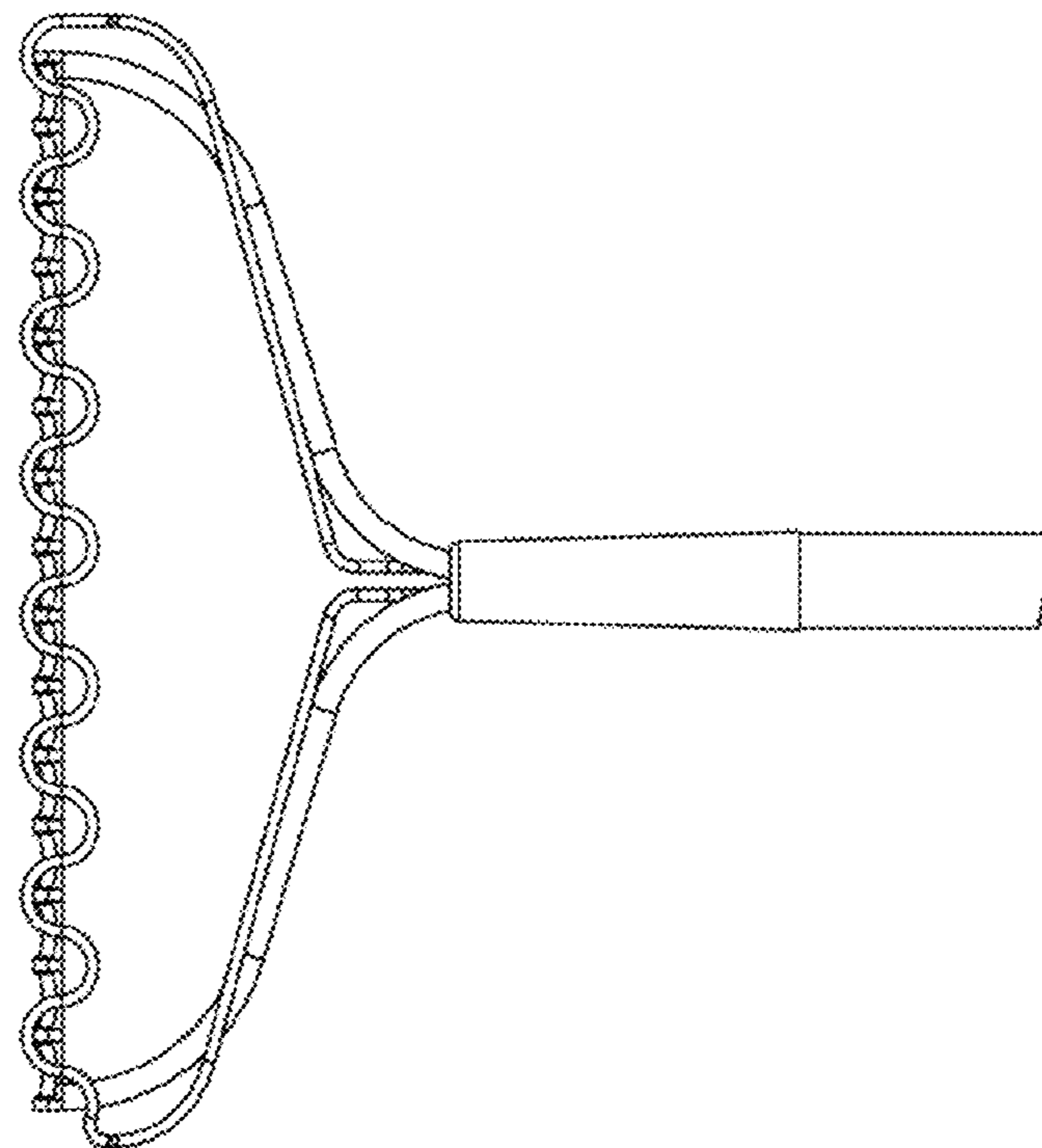

Figure 4



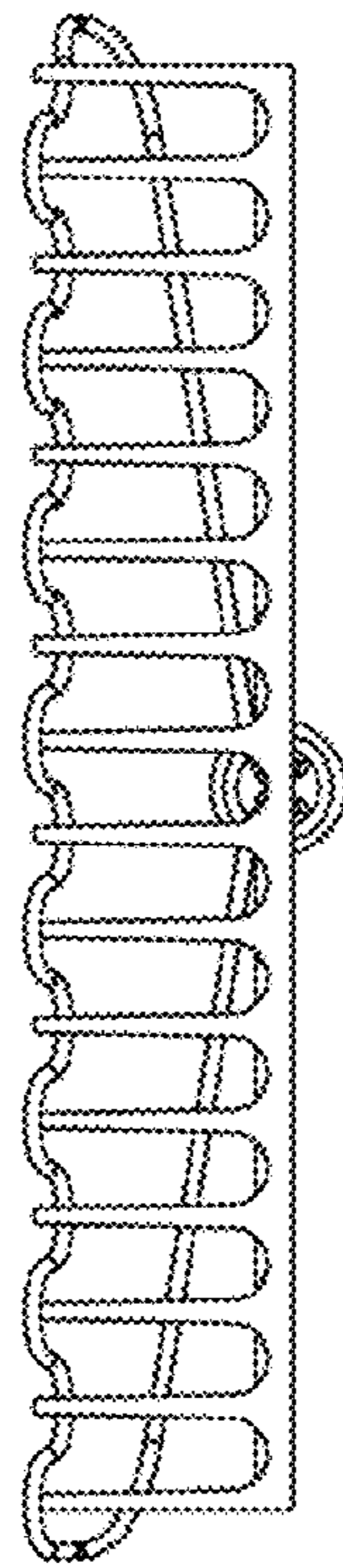

Figure 5

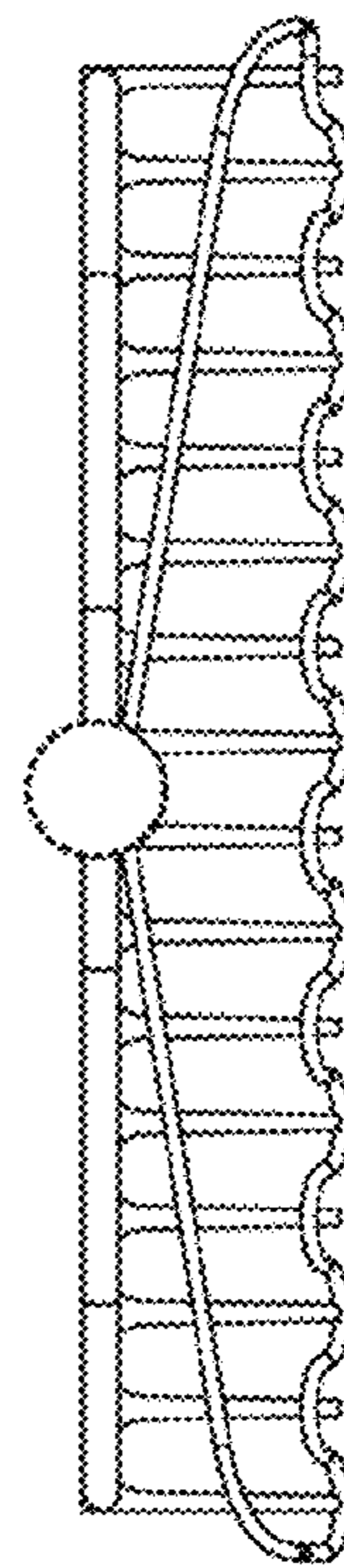

Figure 6

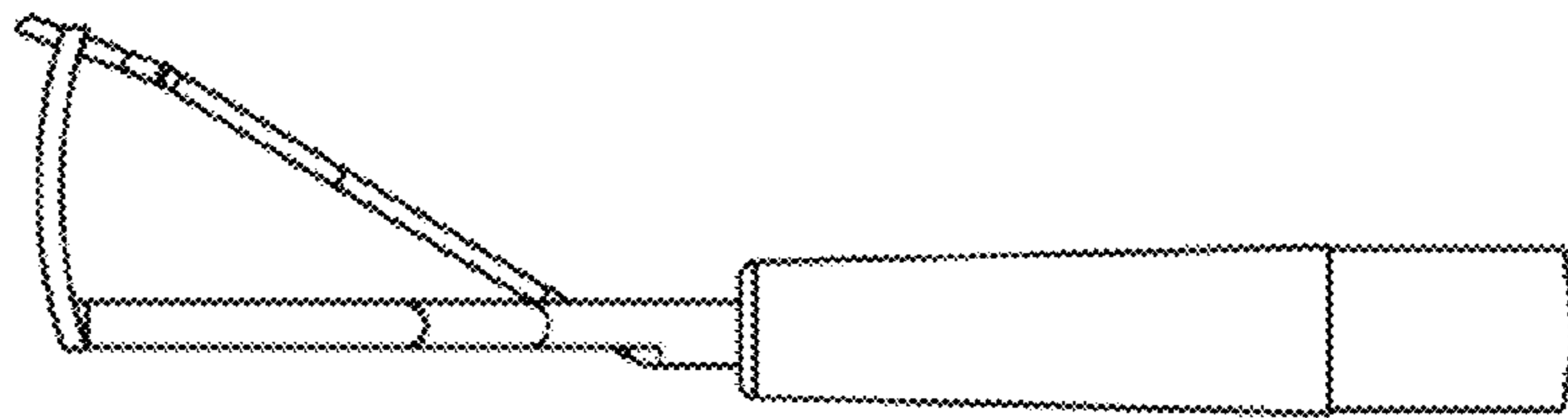

Figure 7

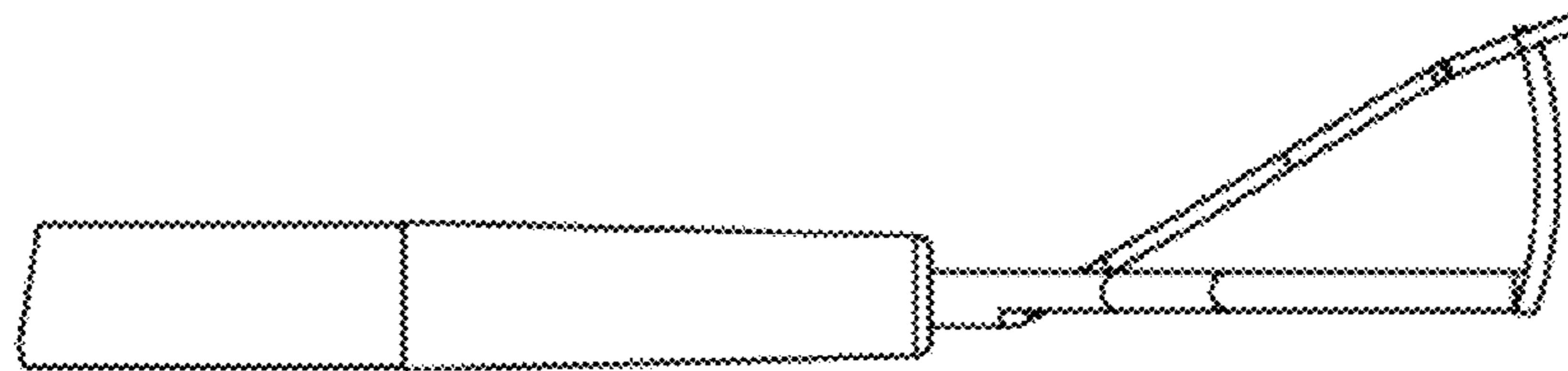

Figure 8

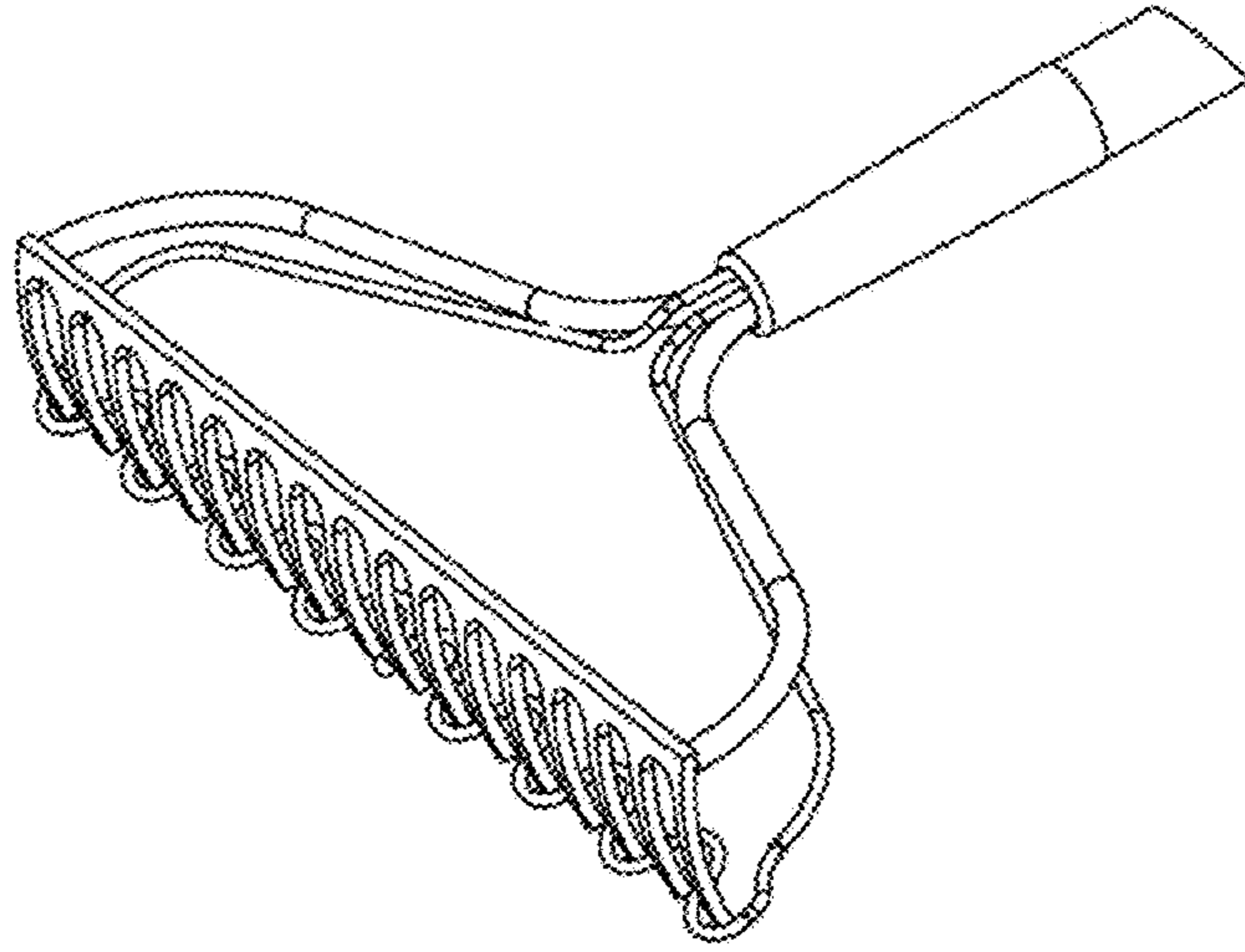

Figure 9

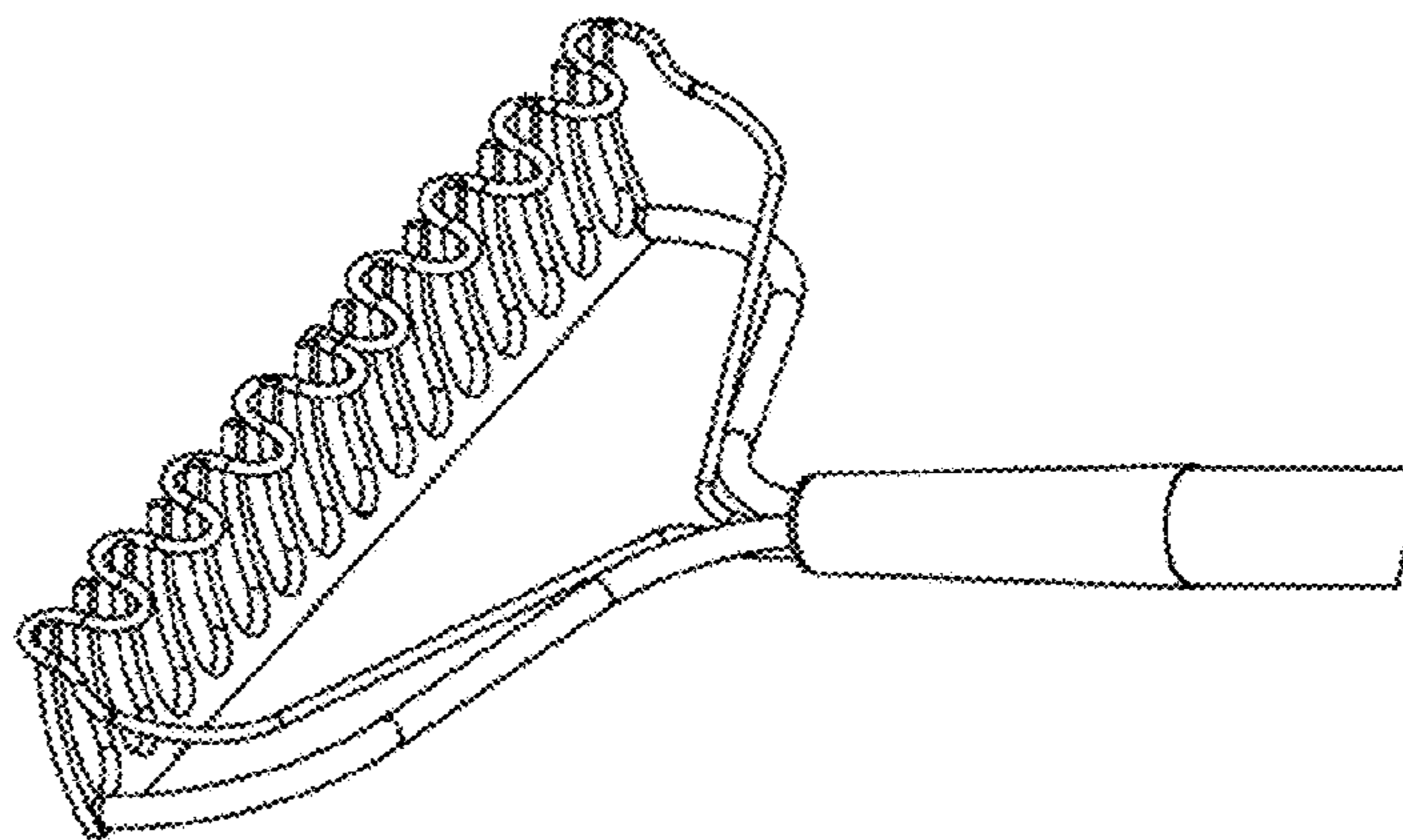

Figure 10

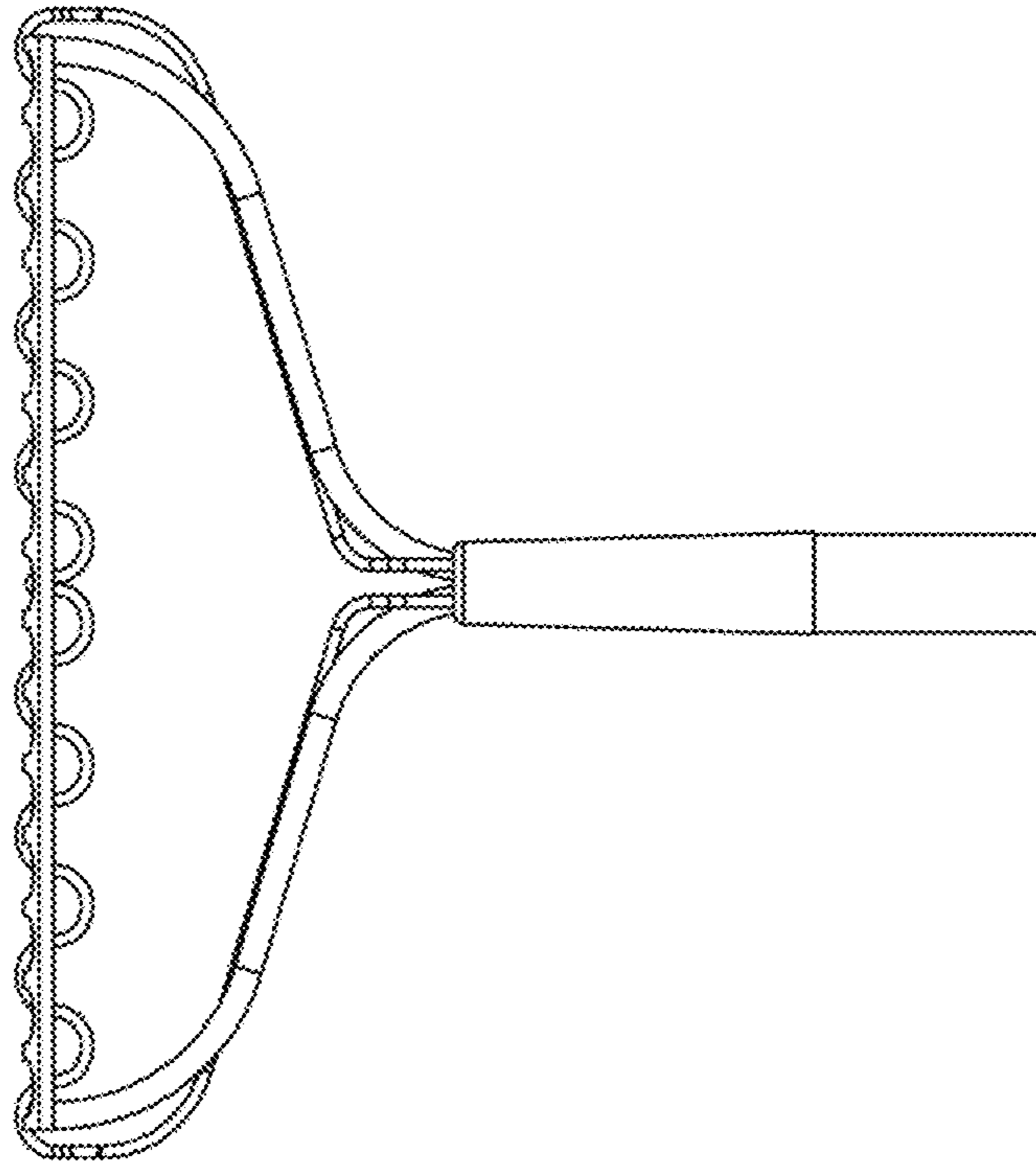

Figure 11

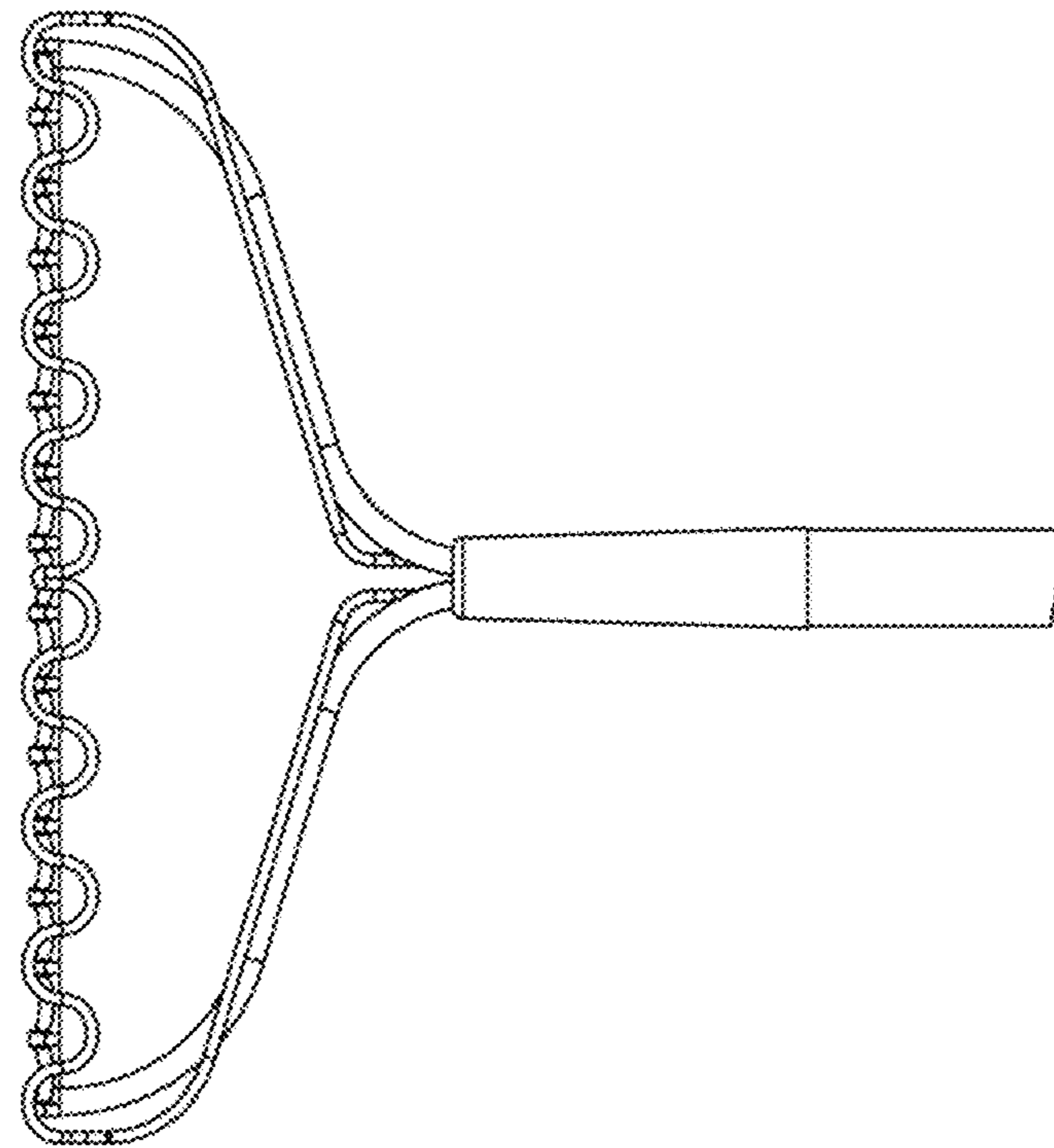

Figure 12



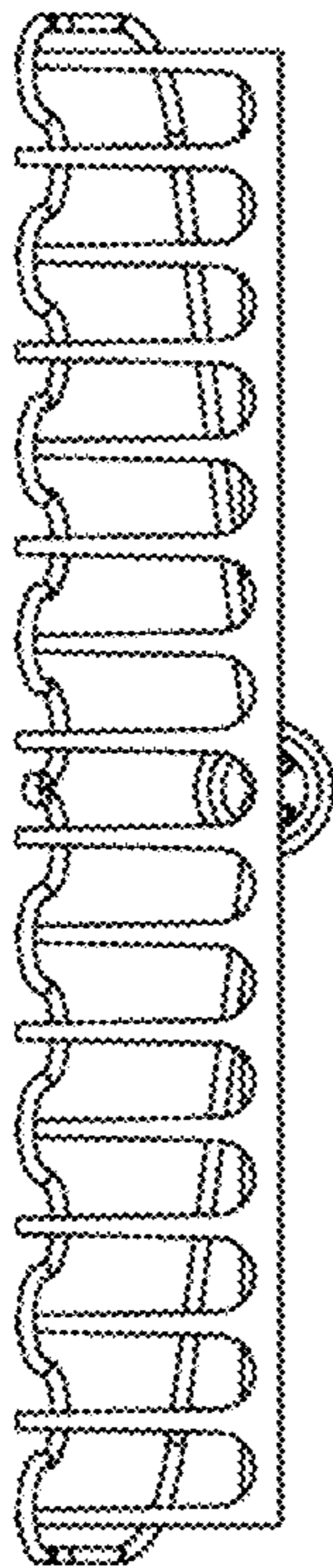

Figure 13

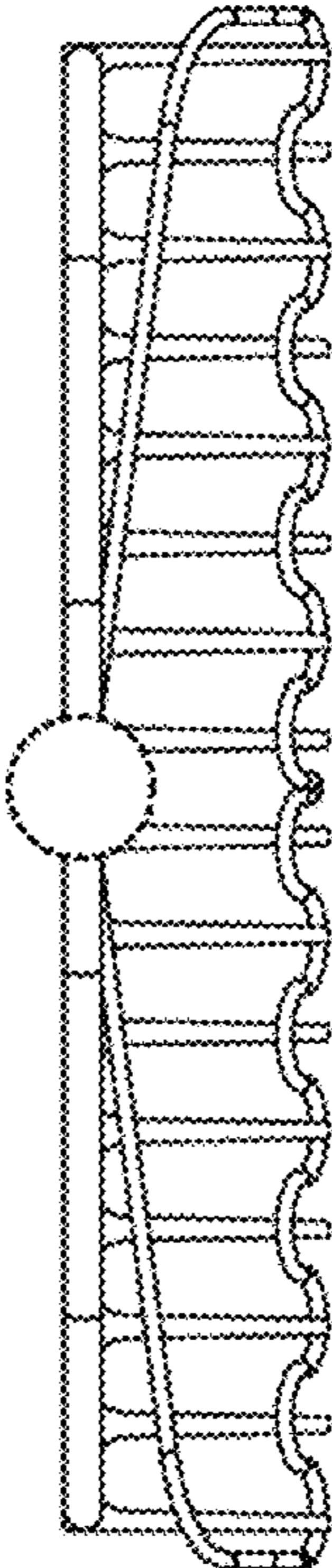

Figure 14

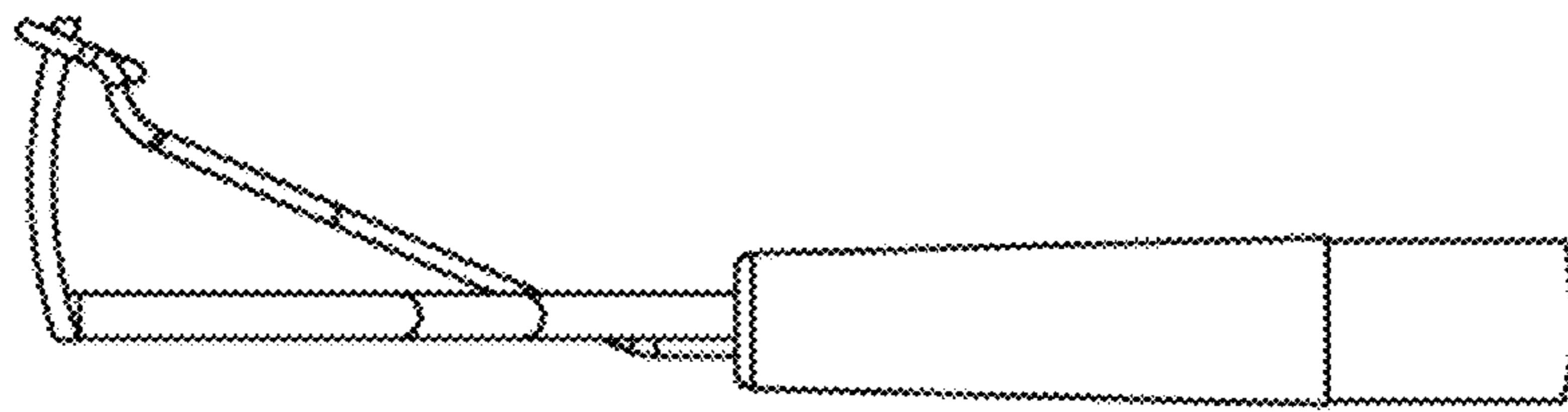

Figure 15

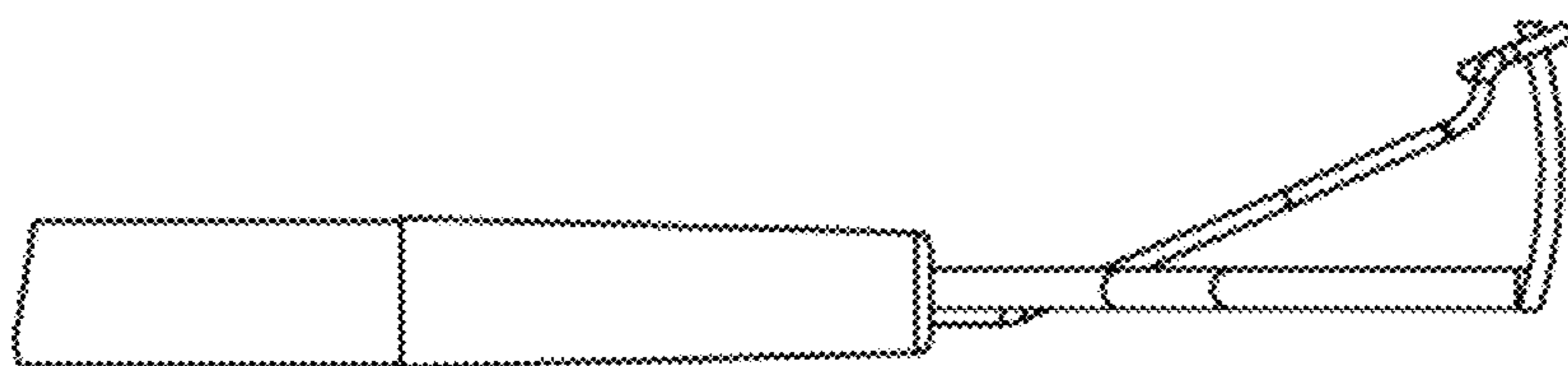

Figure 16

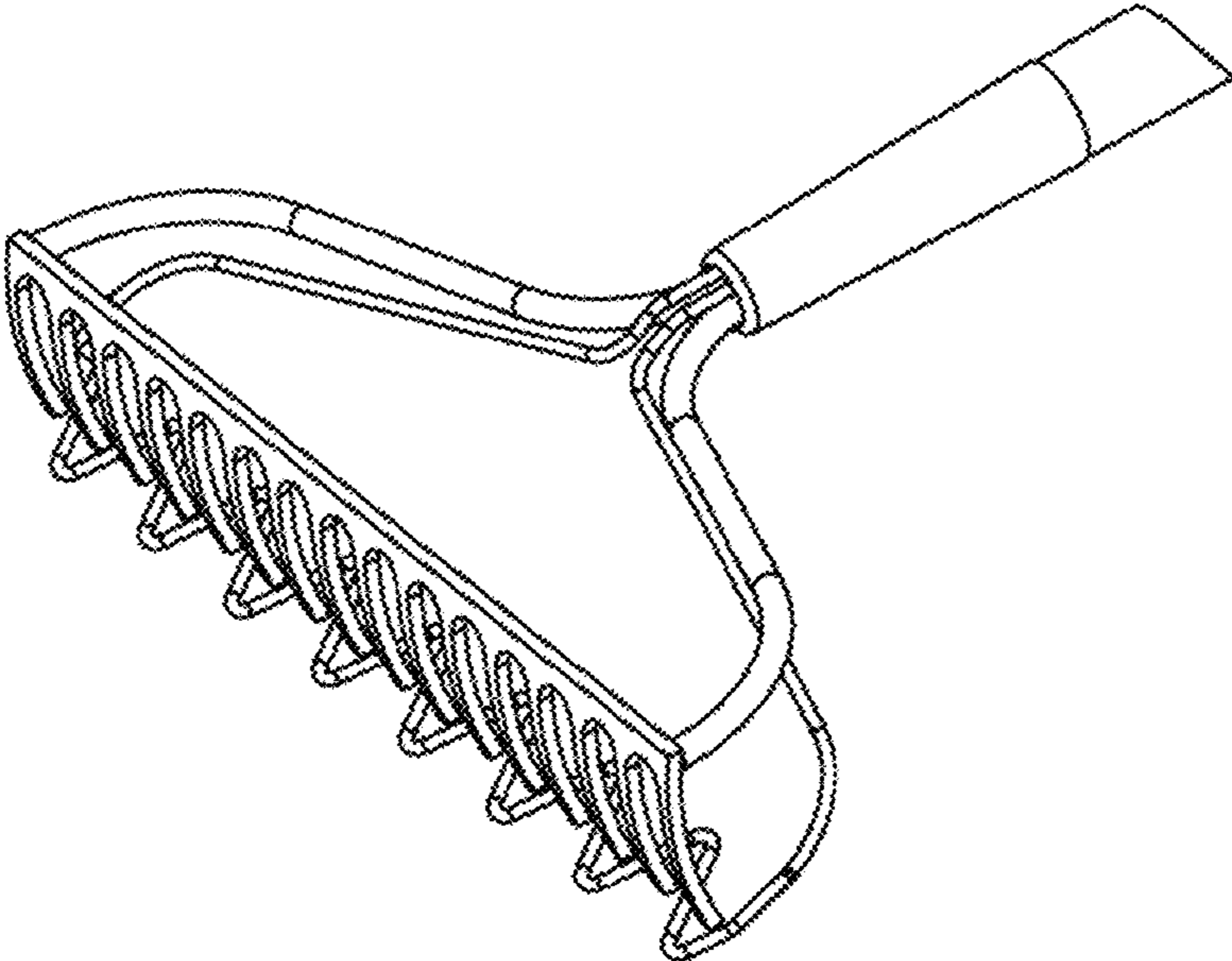

Figure 17

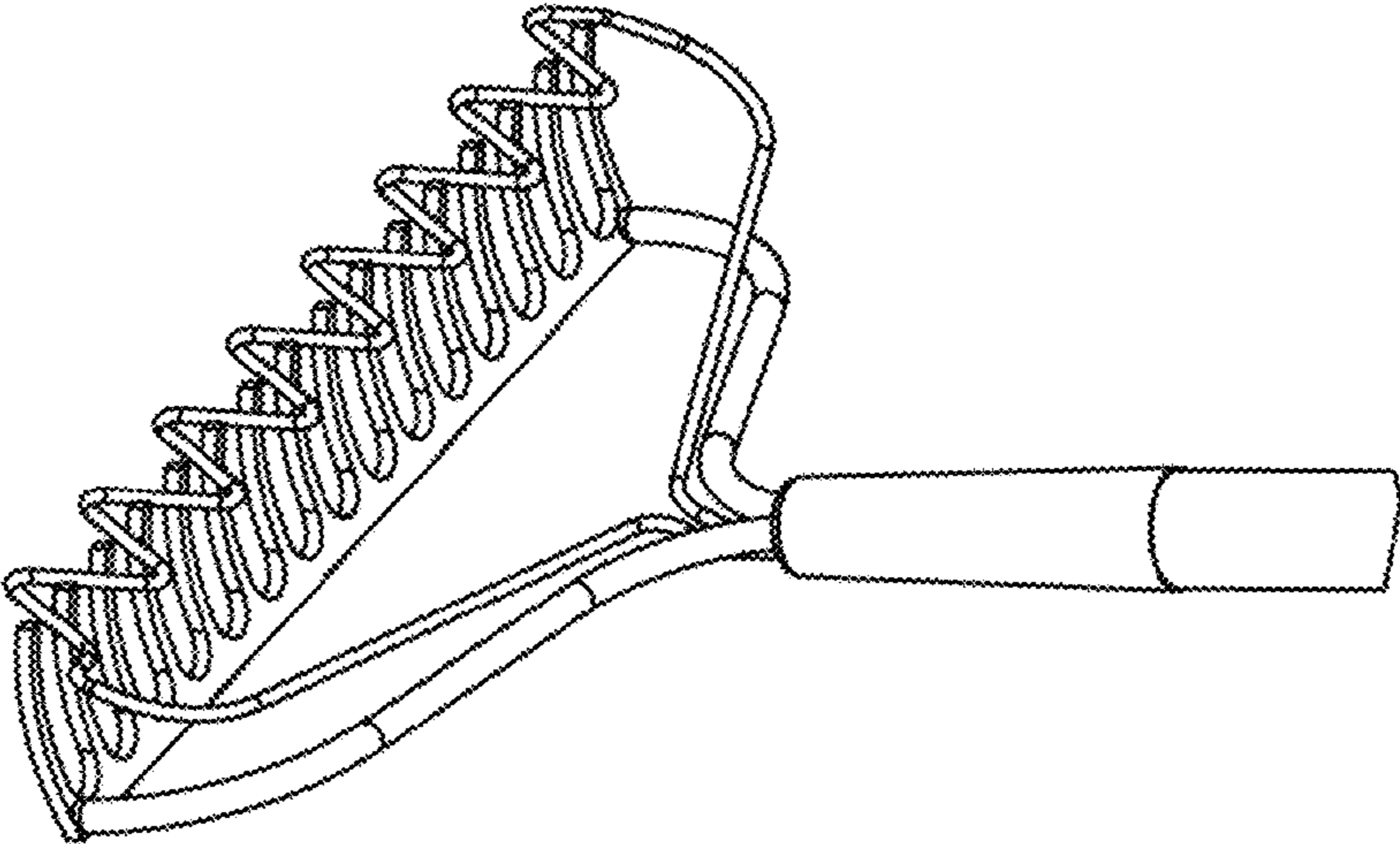

Figure 18

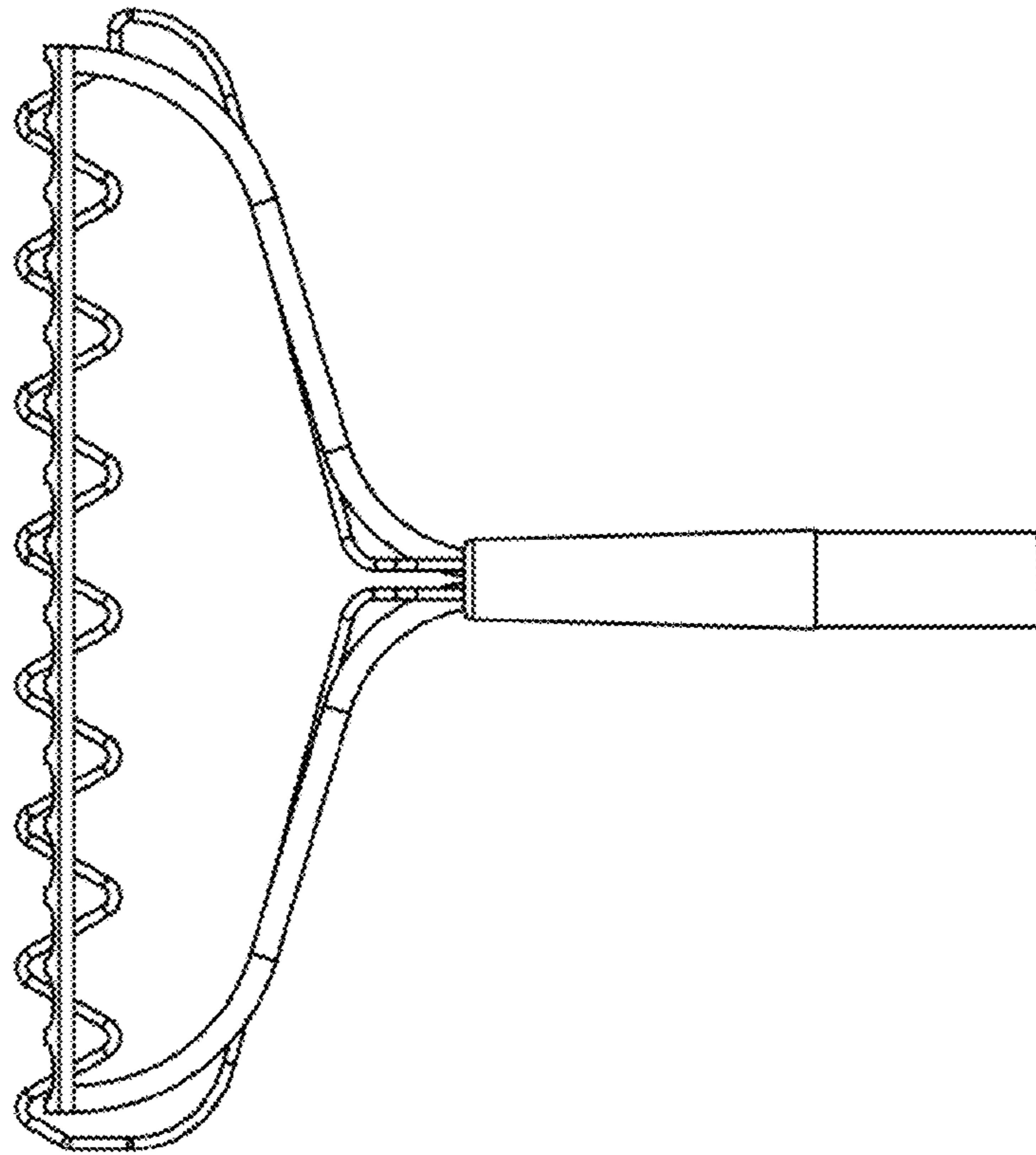

Figure 19

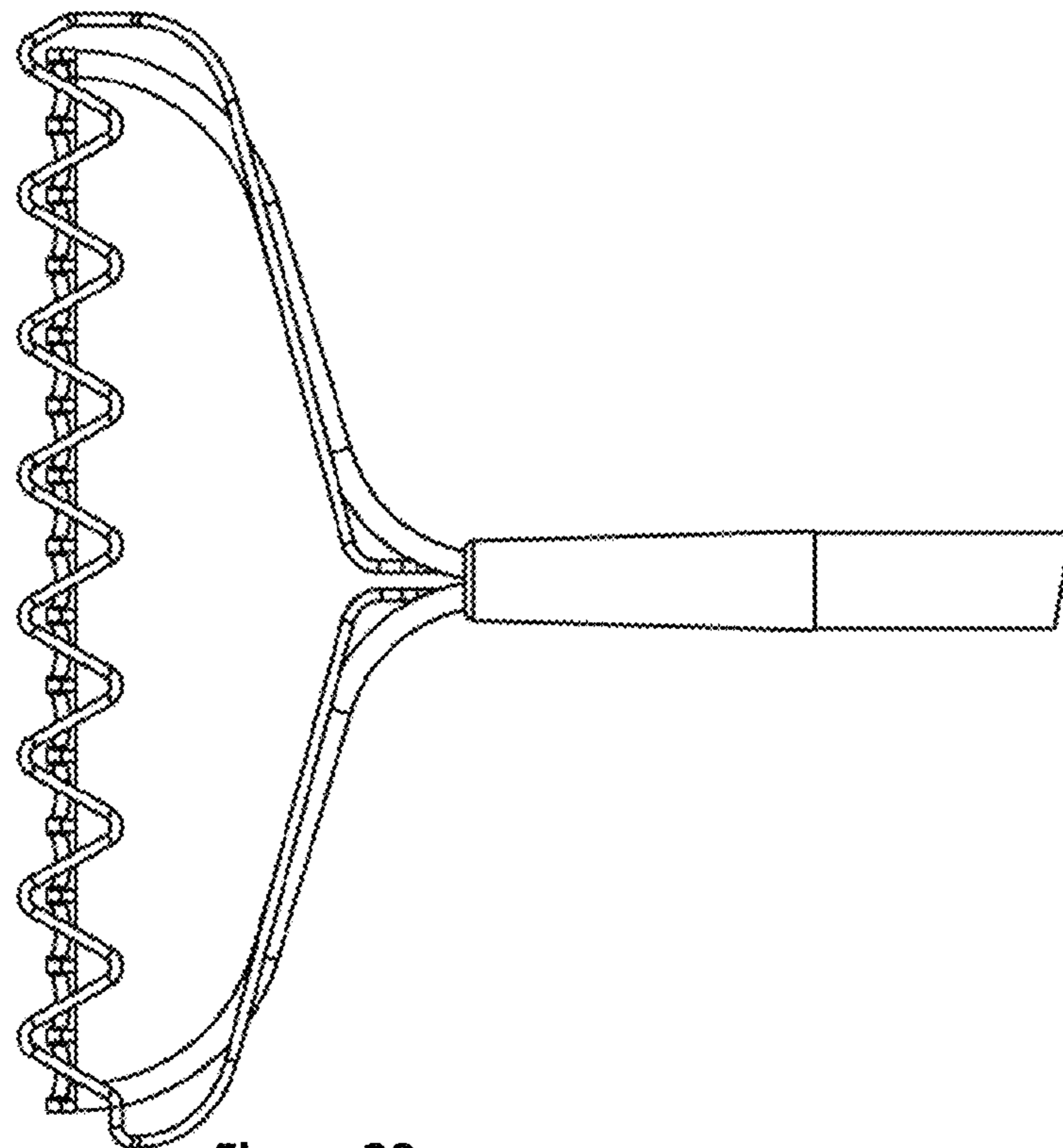

Figure 20

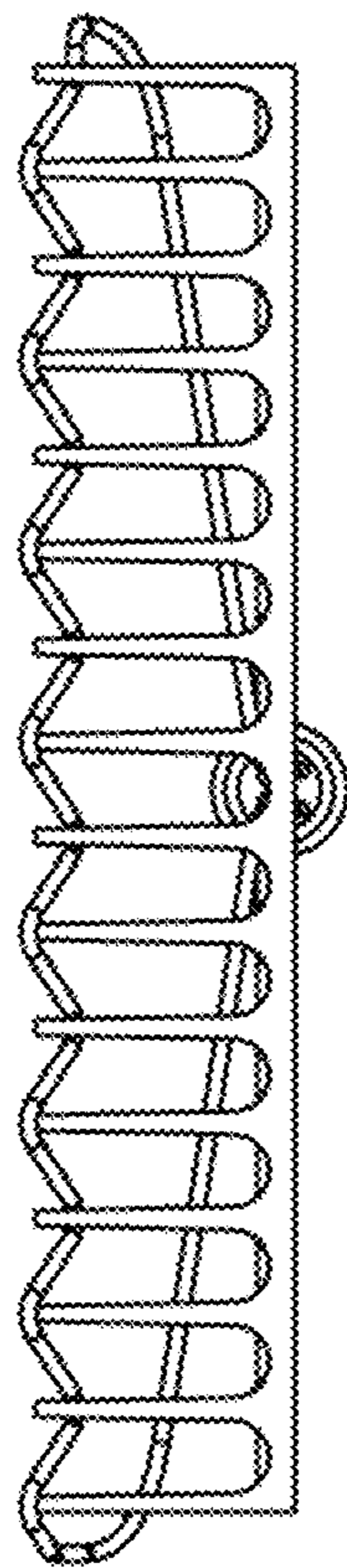

Figure 21

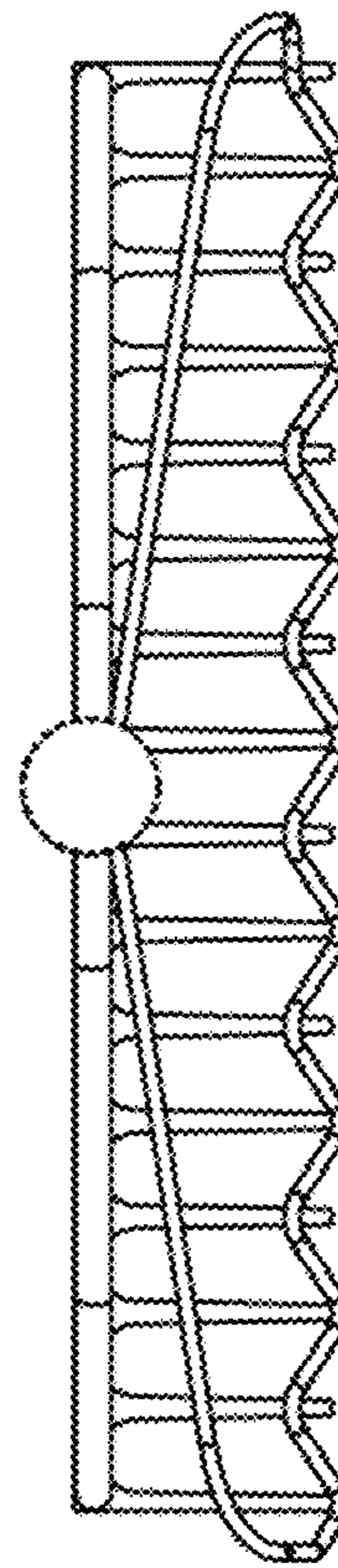

Figure 22



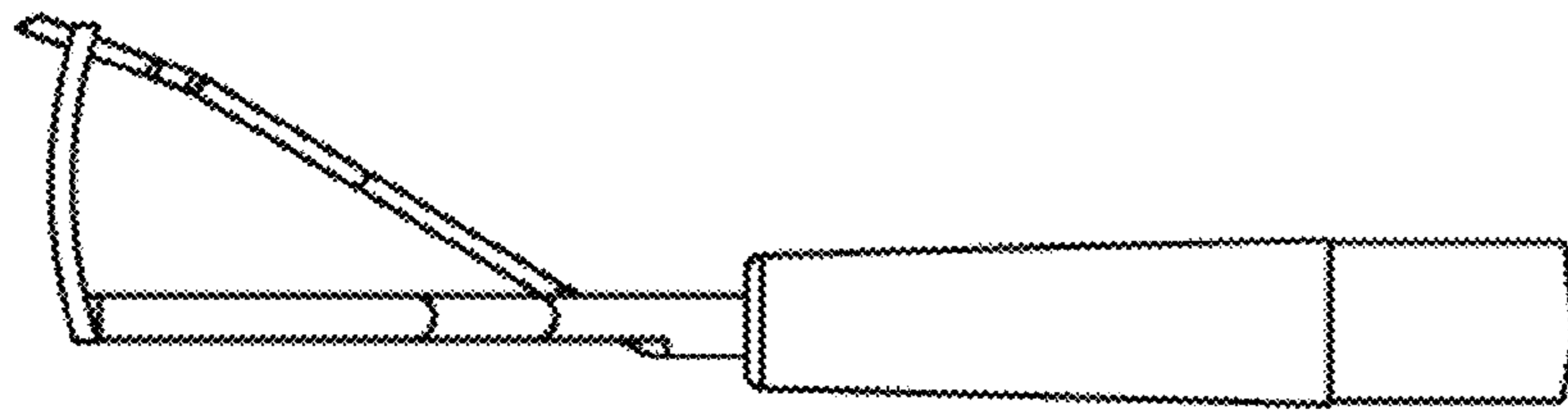

Figure 23

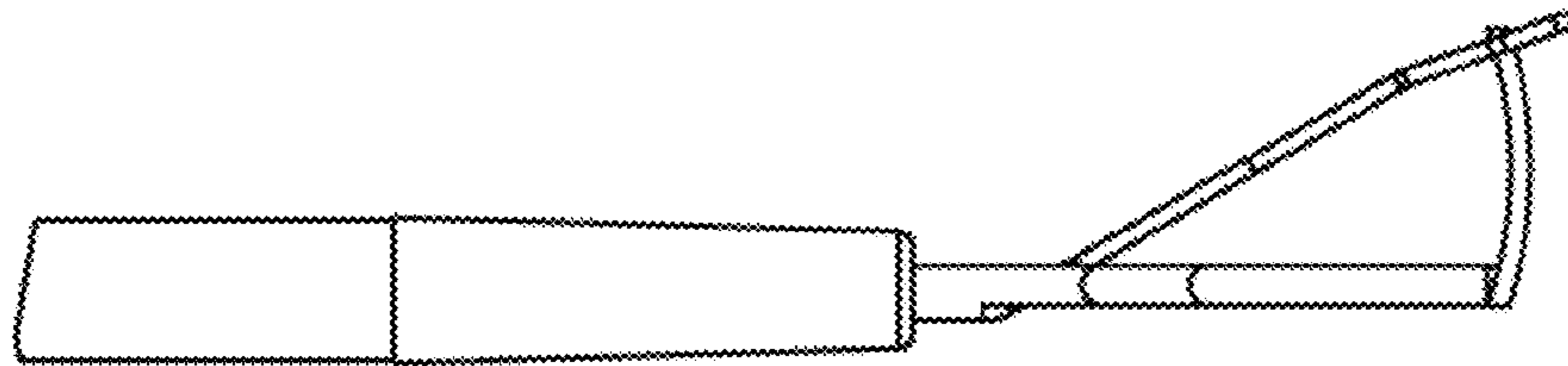

Figure 24