



US00D703476S

(12) **United States Design Patent**
Behar et al.

(10) **Patent No.:** **US D703,476 S**
(45) **Date of Patent:** **** Apr. 29, 2014**

(54) **DOMESTIC SODA-WATER PREPARING DEVICE**

(75) Inventors: **Yves Behar**, San Francisco, CA (US);
Gabriel Joshua Lamb, Burlingame, CA (US)

(73) Assignee: **Soda Stream Industries Ltd**, Air Port (IL)

(**) Term: **14 Years**

(21) Appl. No.: **29/429,664**

(22) Filed: **Aug. 15, 2012**

(30) **Foreign Application Priority Data**

Feb. 20, 2012 (EM) 001995085-0001

(51) **LOC (10) Cl.** **07-01**

(52) **U.S. Cl.**
USPC **D7/306; D7/311**

(58) **Field of Classification Search**
USPC D7/306-311, 300, 305; 99/282, 279,
99/280, 300, 305; 222/146.5, 129.1
See application file for complete search history.

(56) **References Cited**

U.S. PATENT DOCUMENTS

D183,532 S * 9/1958 McCauly D7/311
D309,395 S * 7/1990 Thompson et al. D7/311

D332,200 S * 1/1993 Credle, Jr. D7/311
D375,431 S * 11/1996 Credle et al. D7/311
6,082,246 A * 7/2000 Thorn et al. 99/284
D498,111 S * 11/2004 Lassota et al. D7/309
D615,339 S * 5/2010 Bronwasser D7/306
D681,385 S * 5/2013 Ring et al. D7/306
D687,664 S * 8/2013 Beghelli D7/306

* cited by examiner

Primary Examiner — Marianne Pandozzi

(74) *Attorney, Agent, or Firm* — Pearl Cohen Zedek Latzer Baratz LLP

(57) **CLAIM**

The ornamental design for a domestic soda-water preparing device, as shown and described.

DESCRIPTION

FIG. 1 is a front elevational view of the domestic soda-water preparing device;
FIG. 2 is a left side elevational view thereof;
FIG. 3 is a top plan view thereof;
FIG. 4 is an enlarged bottom plan view thereof;
FIG. 5 is a back elevational view thereof;
FIG. 6 is a right side elevational view thereof;
FIG. 7 is a top, back, left side, perspective view thereof; and,
FIG. 8 is a top, front, right side, perspective view thereof.
The portions shown in broken line form no part of the claims subject matter.

1 Claim, 8 Drawing Sheets

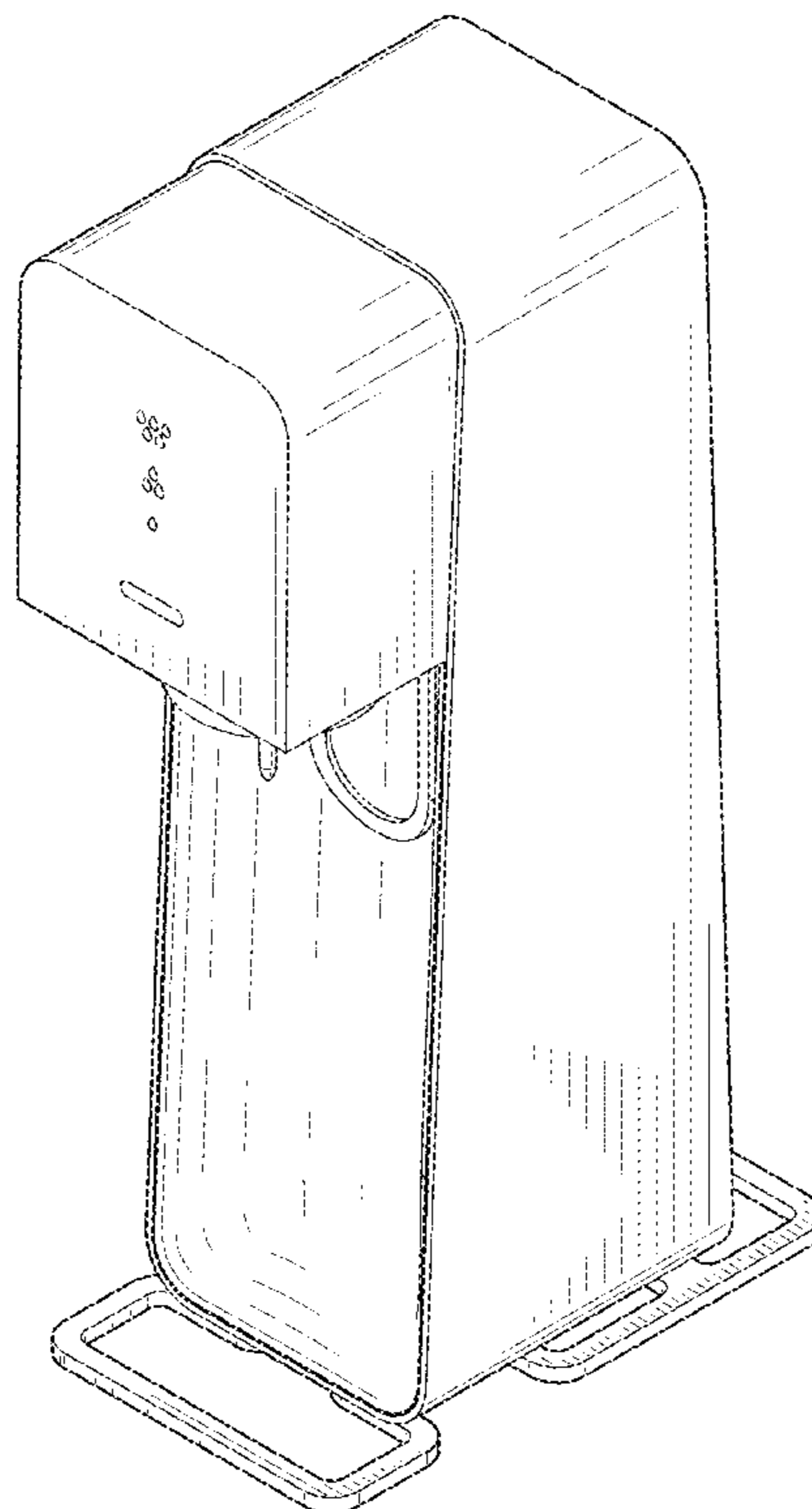

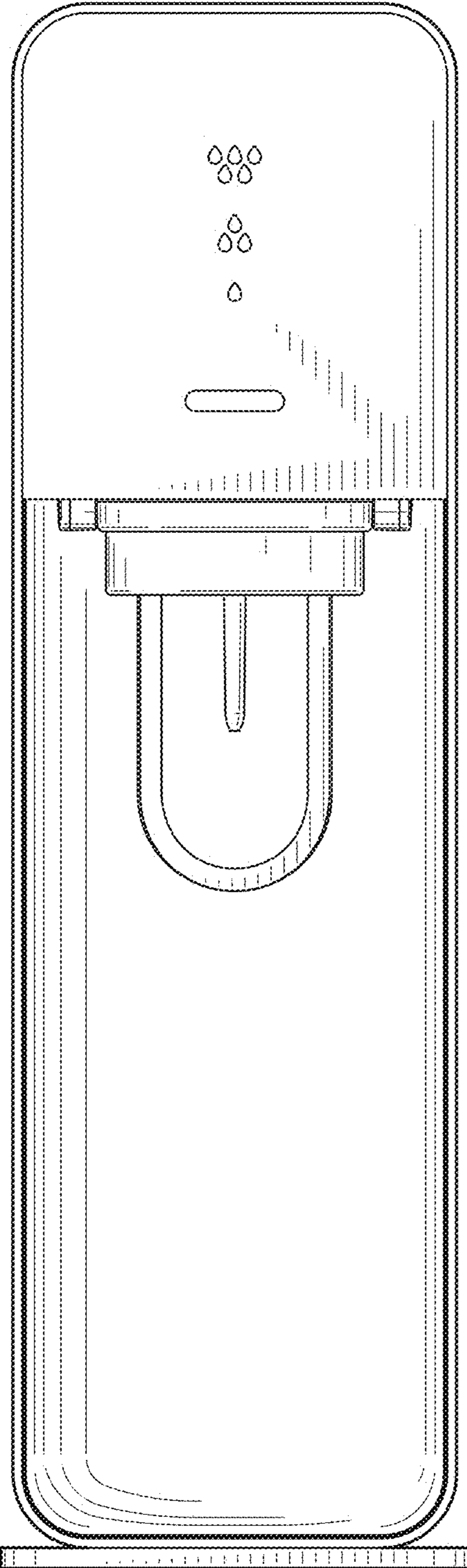

FIG.1

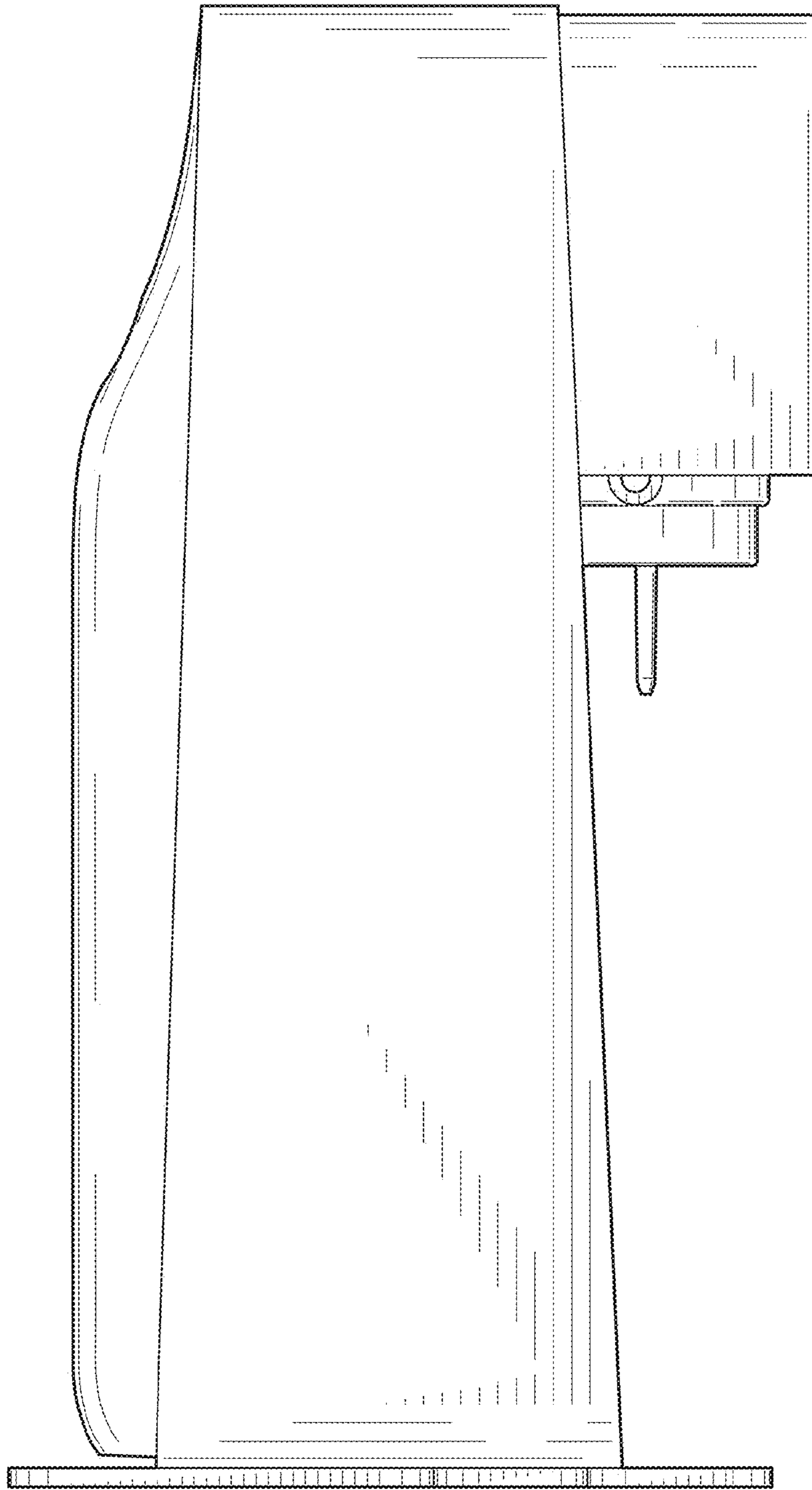

FIG.2

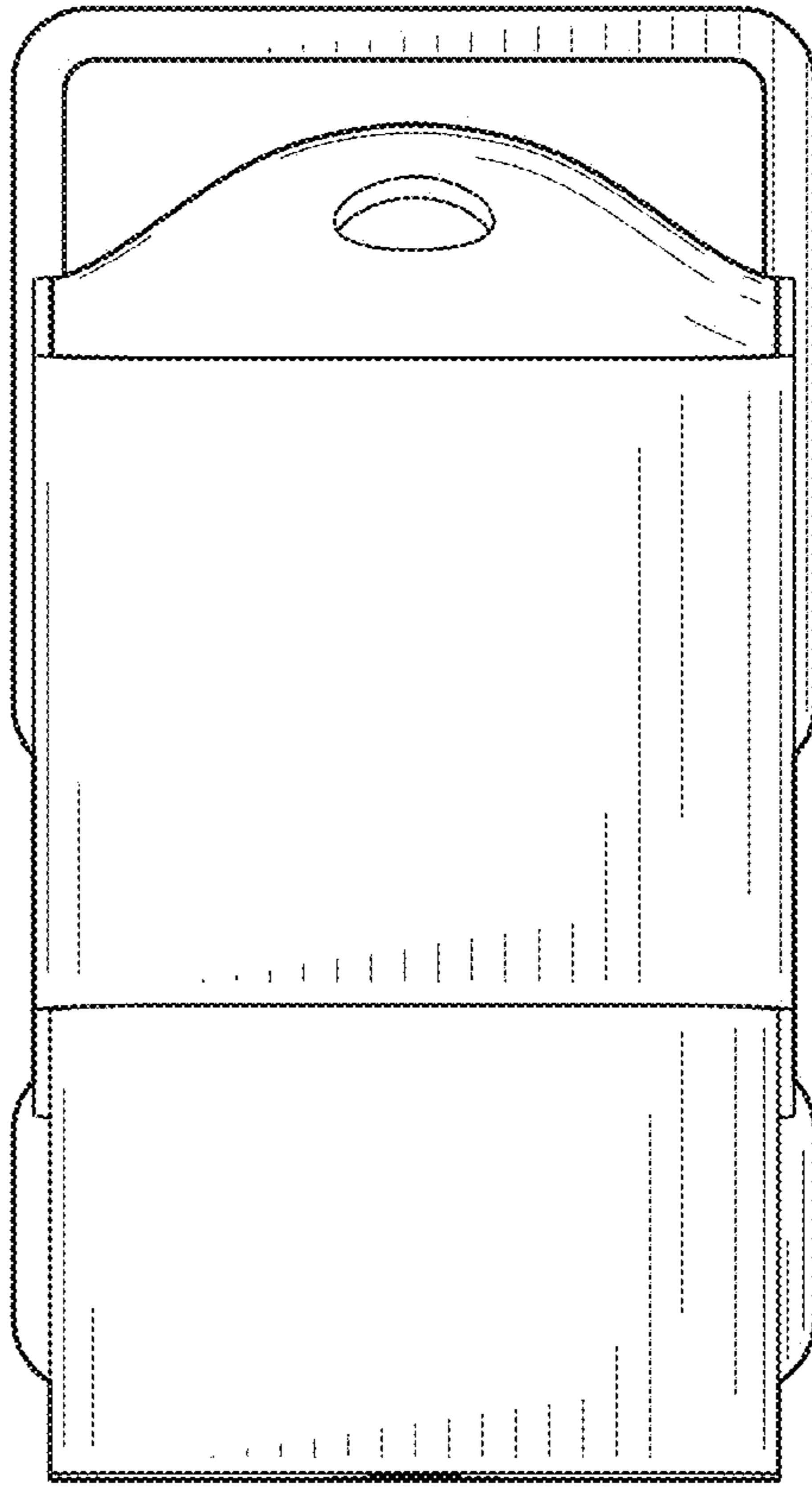

FIG. 3

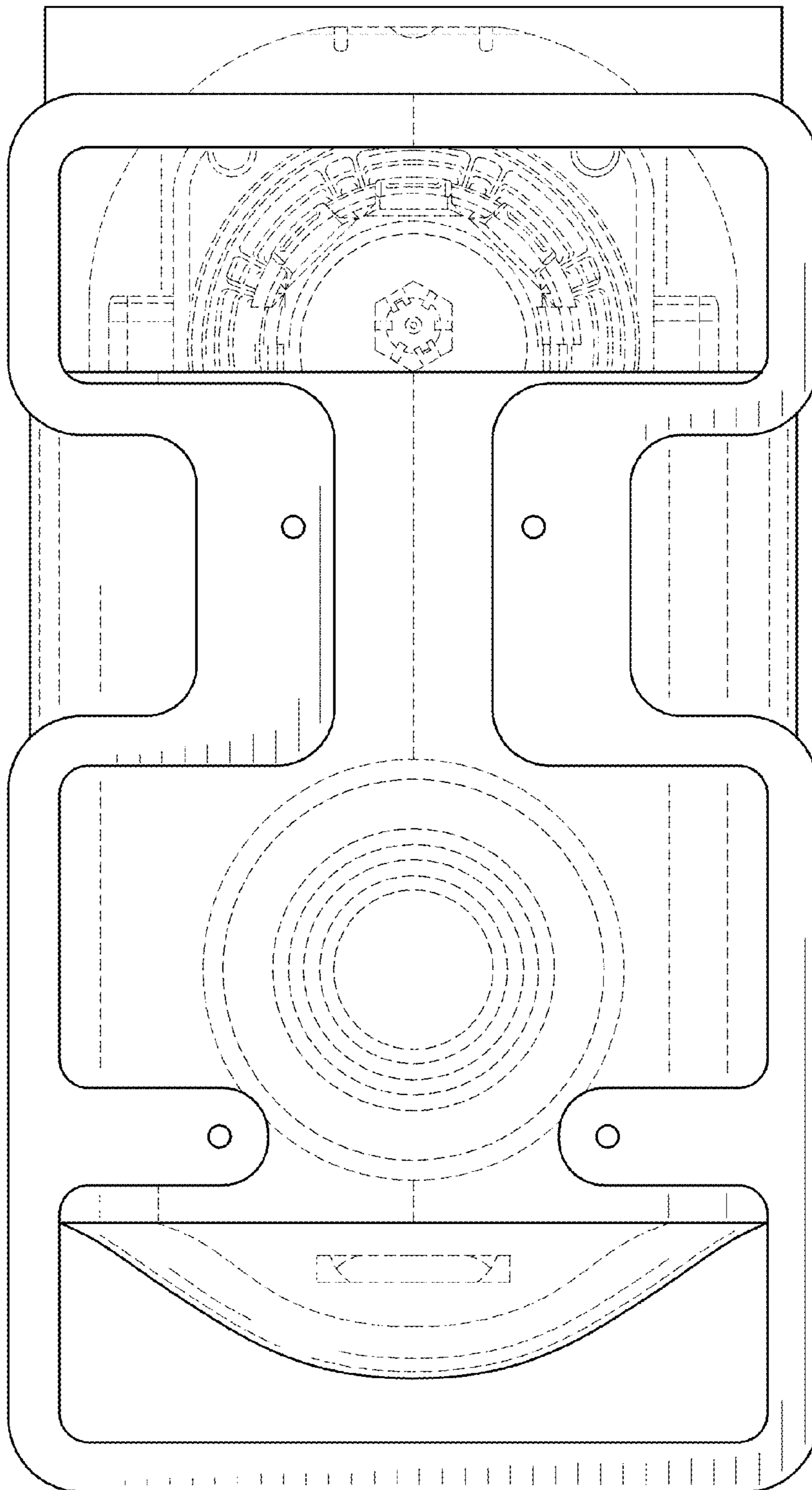

FIG. 4

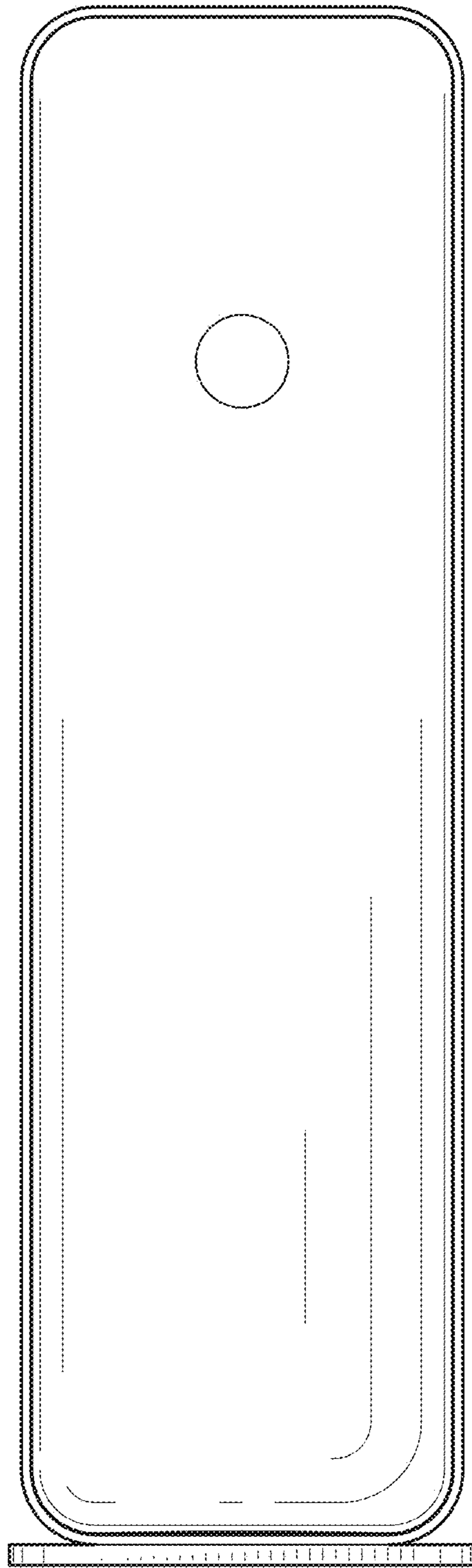

FIG. 5

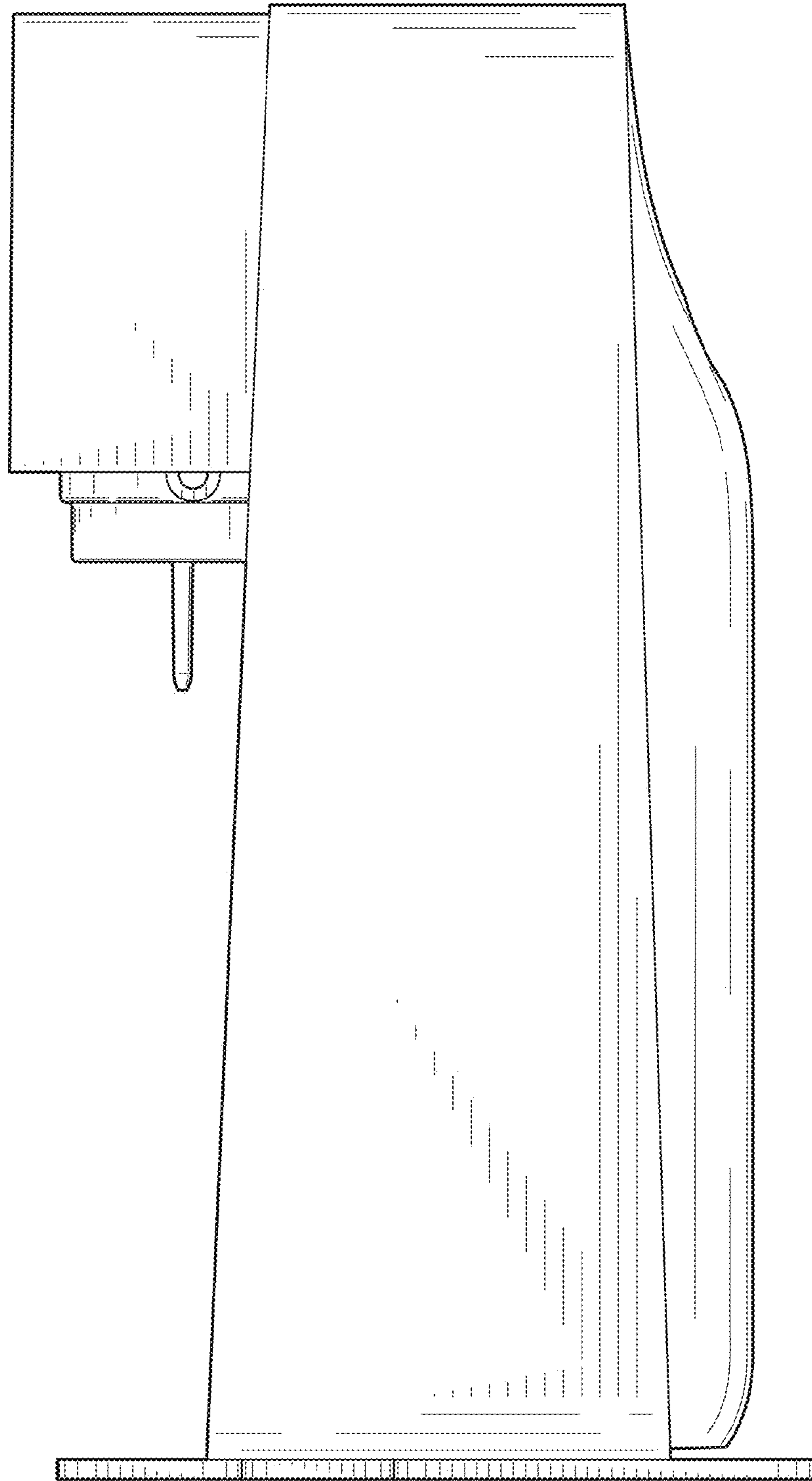

FIG. 6

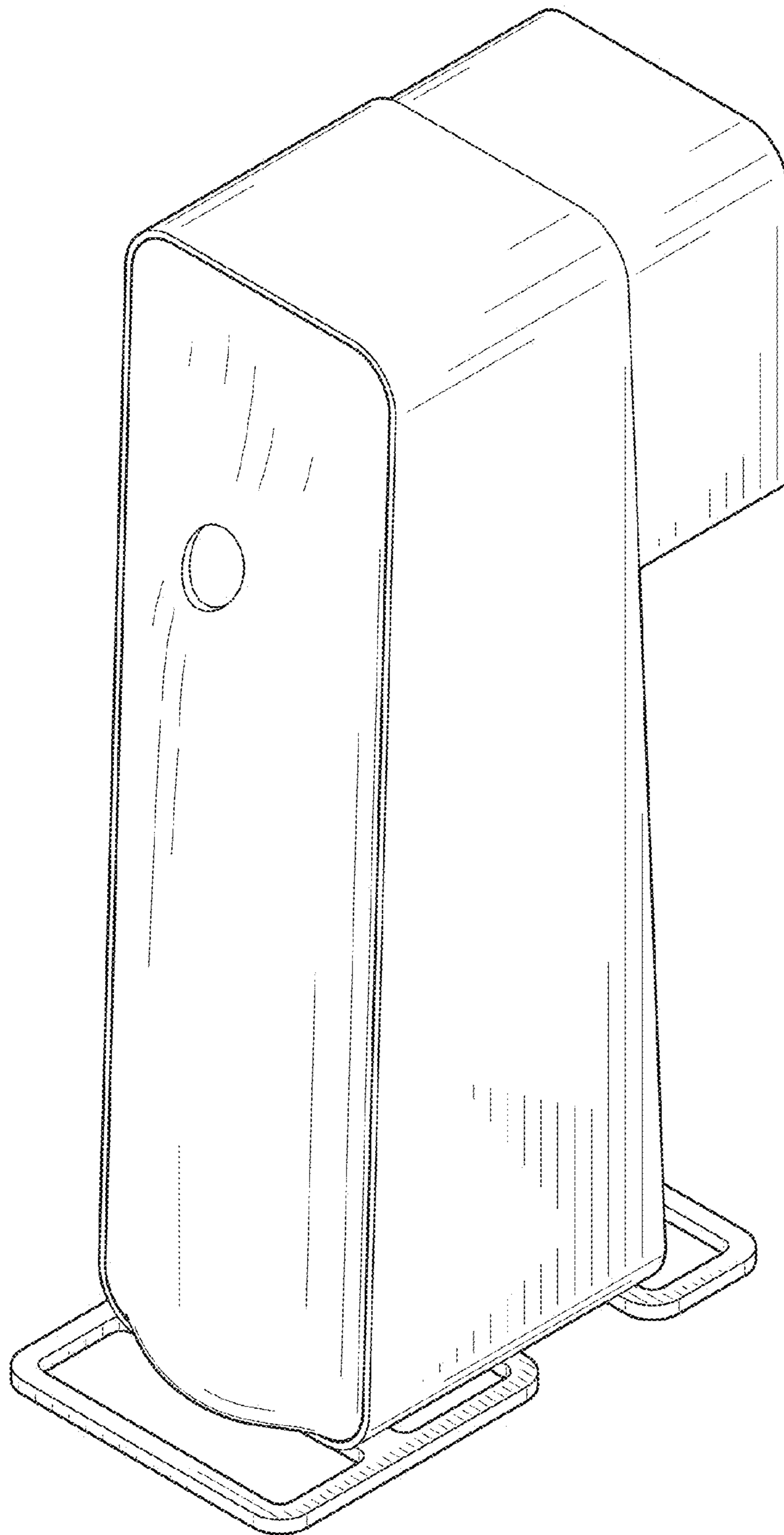

FIG. 7

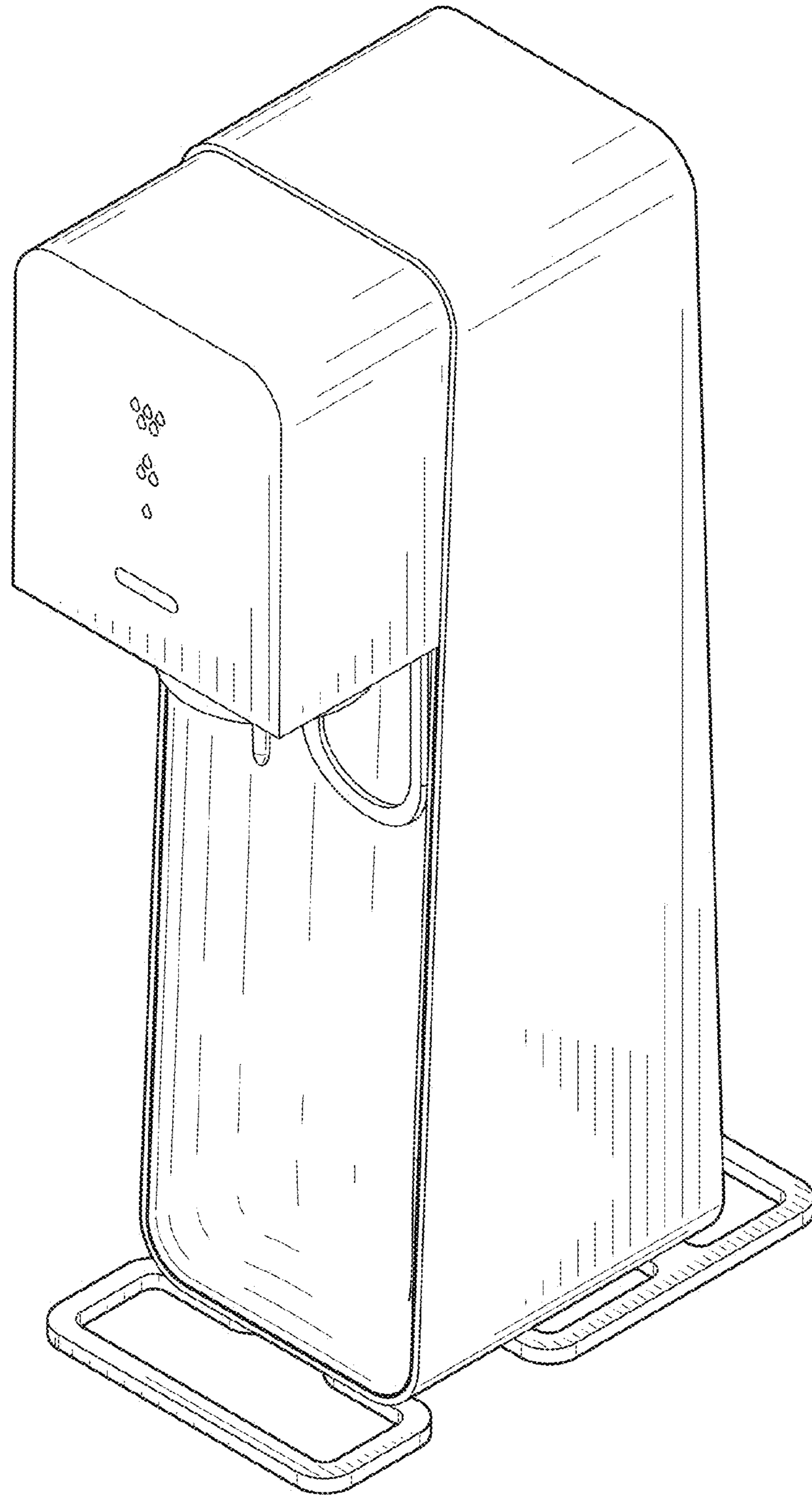

FIG. 8