



US00D703433S

(12) **United States Design Patent**
Morszeck

(10) **Patent No.:** **US D703,433 S**

(45) **Date of Patent:** **** Apr. 29, 2014**

(54) **WALLET**

(71) Applicant: **Rimowa GmbH**, Cologne (DE)

(72) Inventor: **Dieter Morszeck**, Cologne (DE)

(73) Assignee: **Rimowa GmbH**, Cologne (DE)

(**) Term: **14 Years**

(21) Appl. No.: **29/434,944**

(22) Filed: **Oct. 18, 2012**

(51) **LOC (10) Cl.** **03-01**

(52) **U.S. Cl.**
USPC **D3/247**

(58) **Field of Classification Search**
USPC D3/247, 249–253; 150/130–132,
150/136–137
See application file for complete search history.

(56) **References Cited**

U.S. PATENT DOCUMENTS

D62,007 S * 2/1923 Hovesepean D3/247
D95,392 S * 4/1935 White D3/243

D96,767 S * 9/1935 Lending D3/243
D443,414 S * 6/2001 Schimmel D3/250
D510,800 S * 10/2005 Jakovljevic D3/253
D593,321 S * 6/2009 Wentz D3/247
D594,228 S * 6/2009 McCormick D3/247

* cited by examiner

Primary Examiner — Holly Baynham

(74) *Attorney, Agent, or Firm* — Maier & Maier, PLLC

(57) **CLAIM**

The ornamental design for a wallet, as shown and described.

DESCRIPTION

FIG. 1 is a perspective view of a wallet, showing my design;
FIG. 2 is a front view thereof;
FIG. 3 is a rear view thereof;
FIG. 4 is a left side view thereof;
FIG. 5 is a right side view thereof;
FIG. 6 is a top view thereof;
FIG. 7 is a bottom view thereof; and,
FIG. 8 is a plan view of the interior thereof.

1 Claim, 4 Drawing Sheets

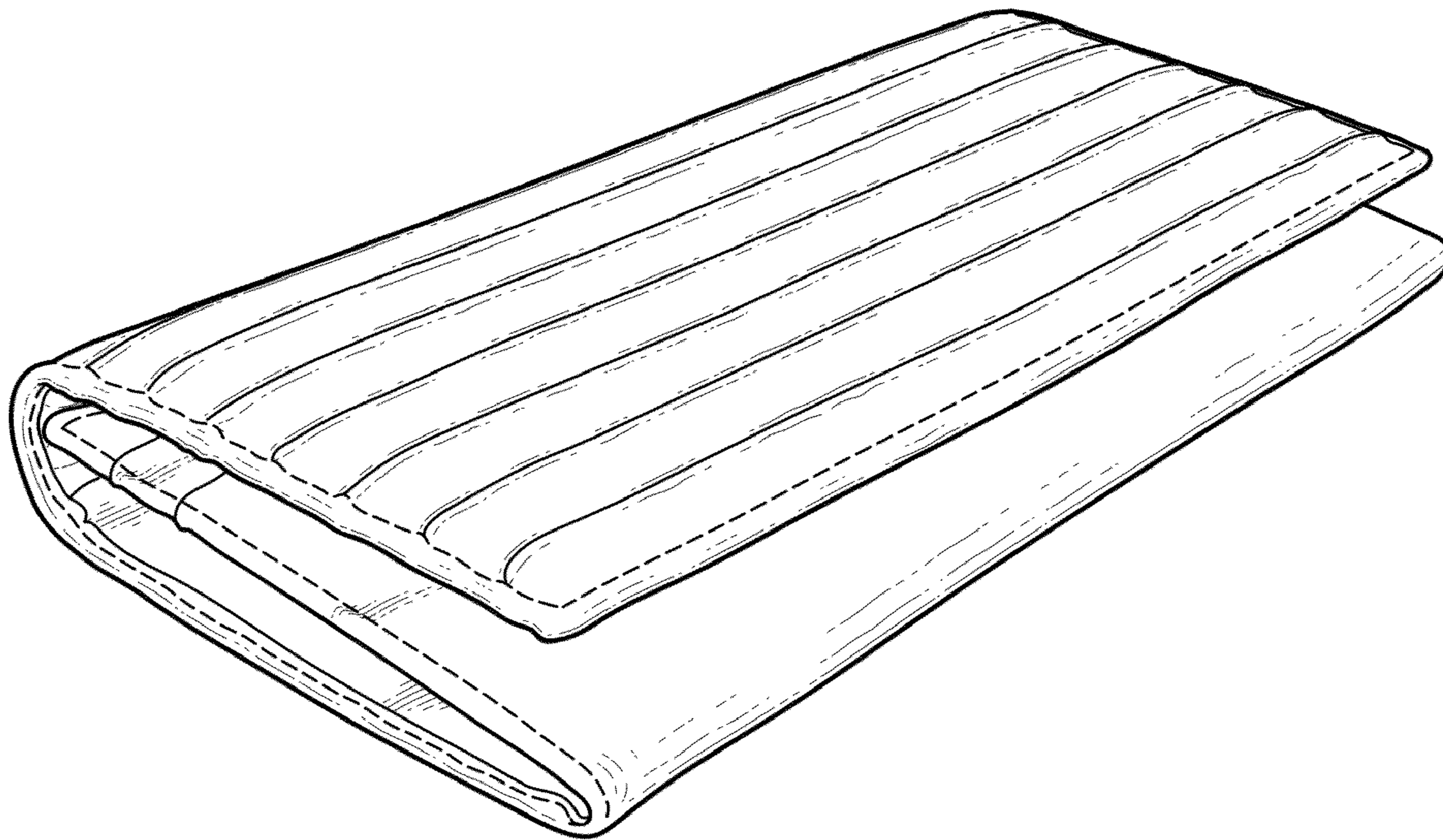

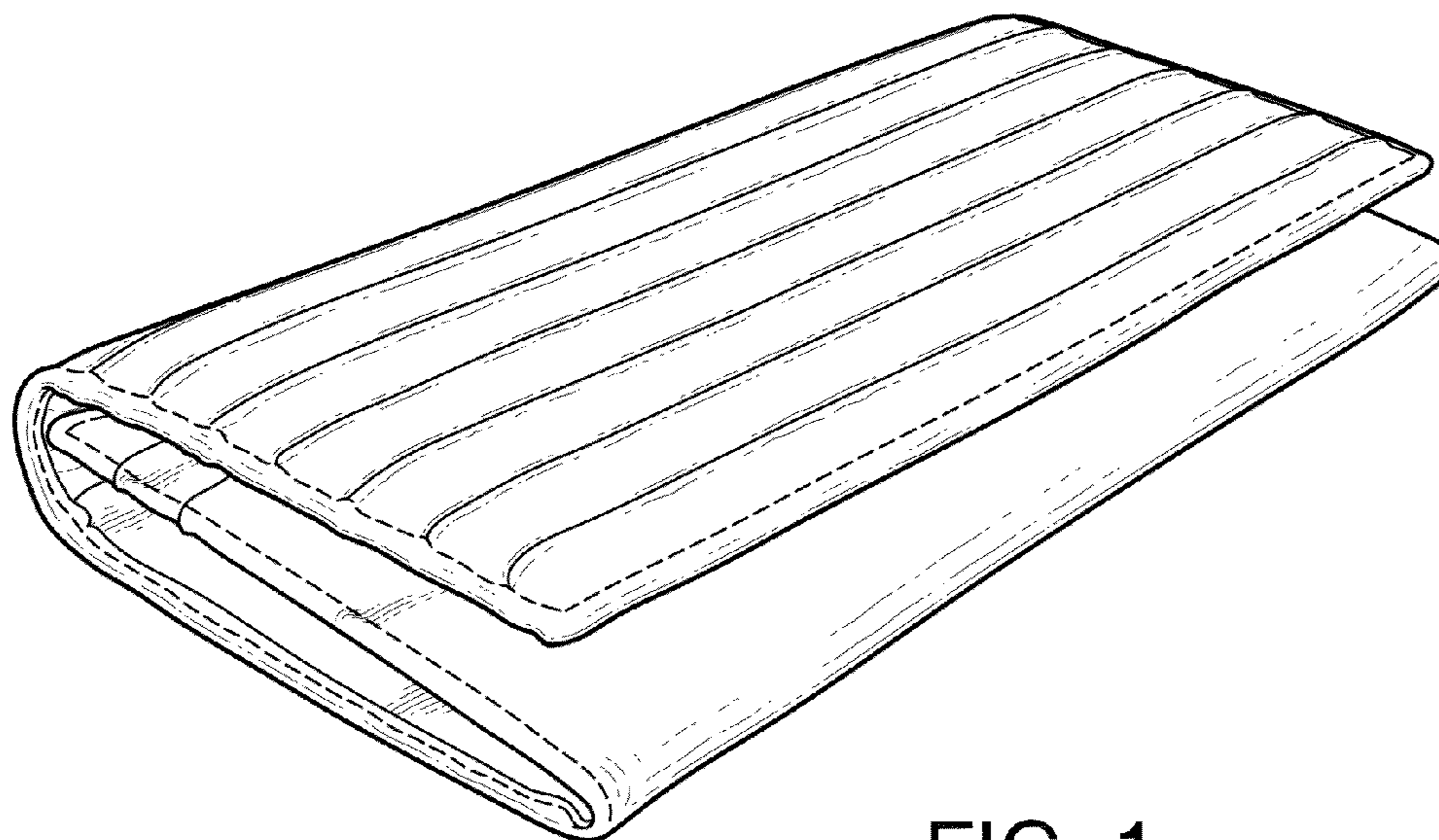

FIG. 1

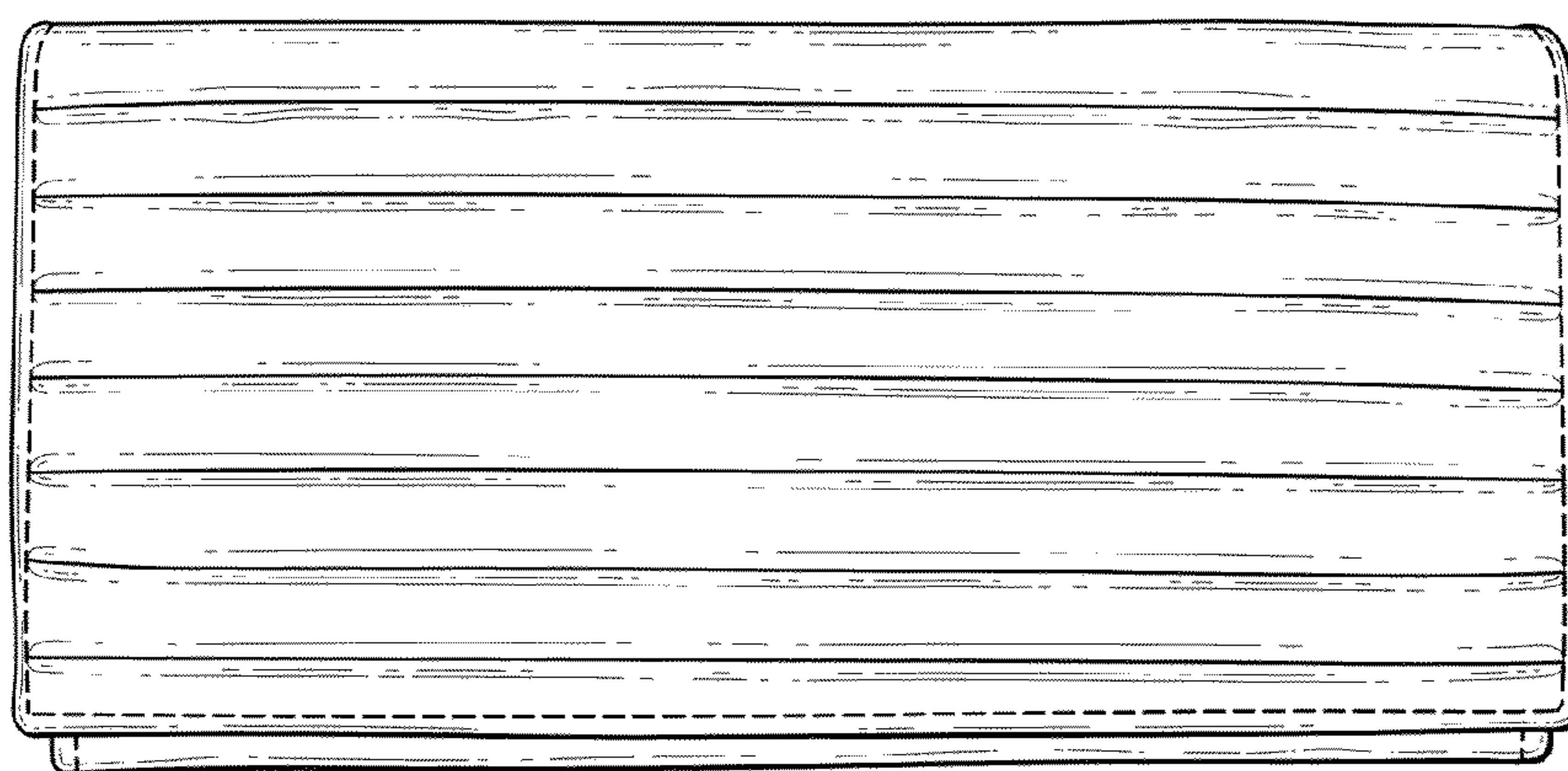

FIG. 2

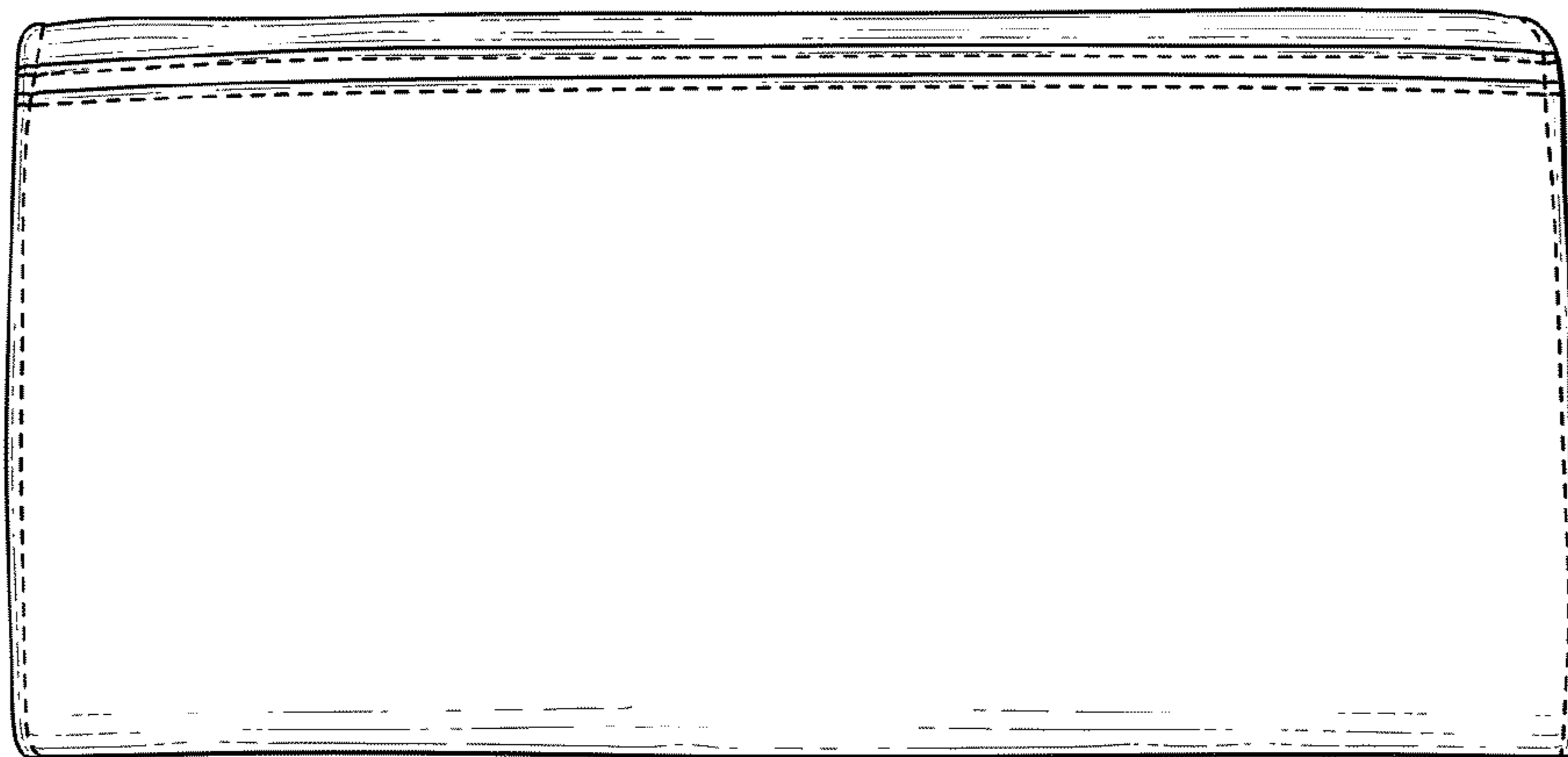

FIG. 3

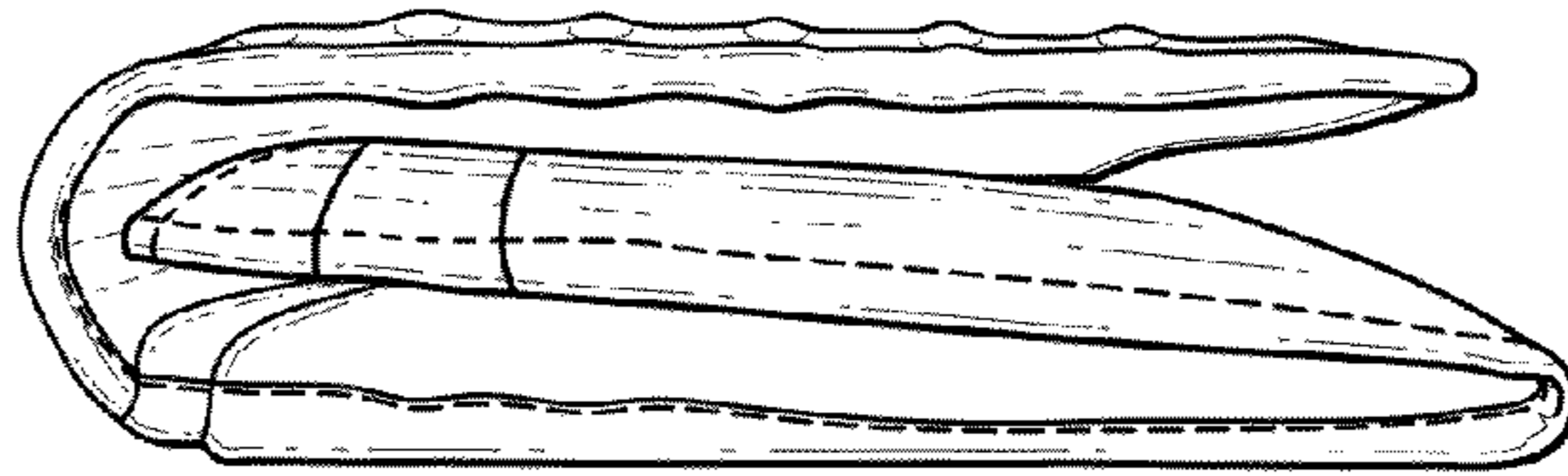

FIG. 4

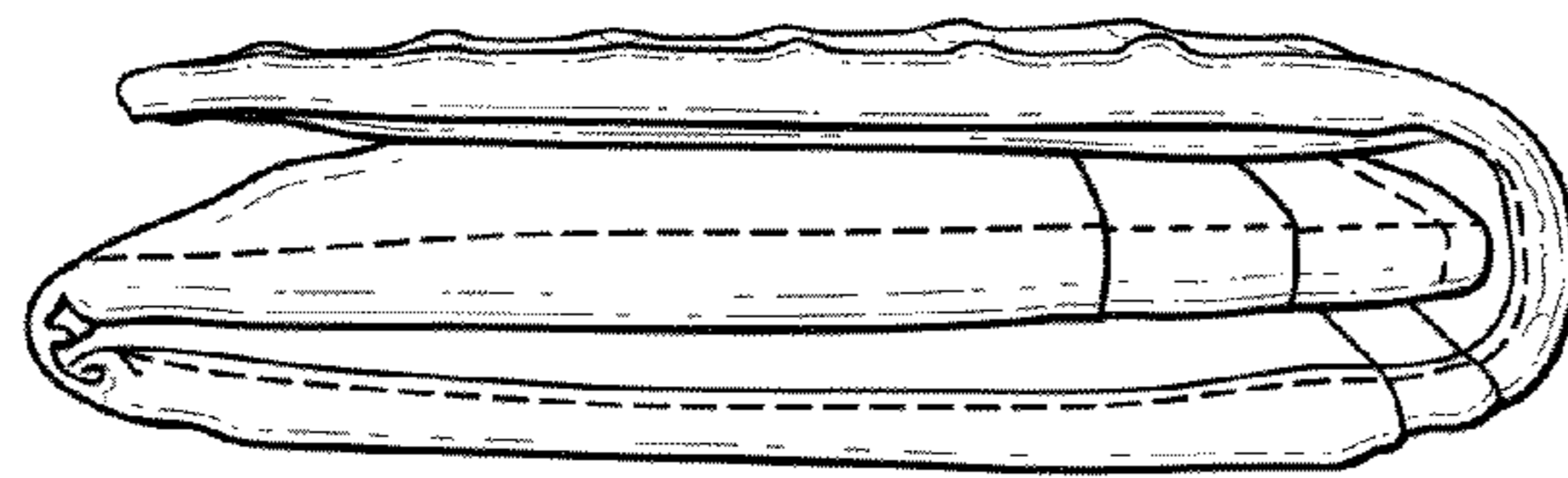

FIG. 5

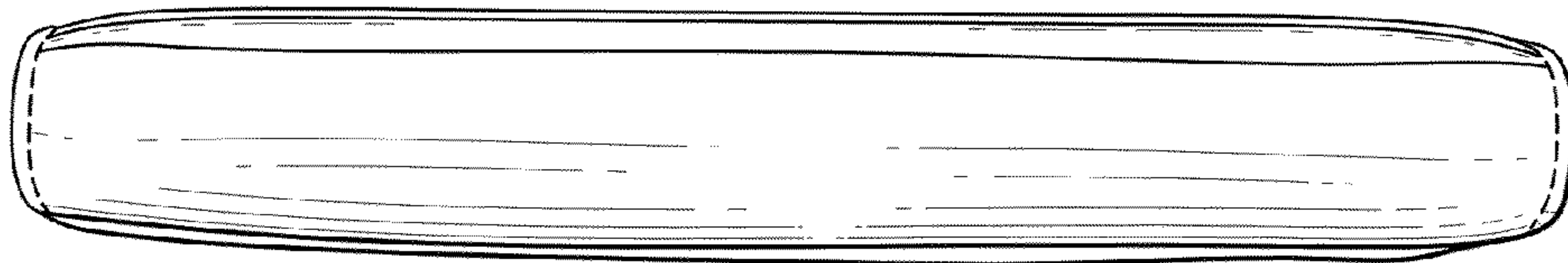

FIG. 6

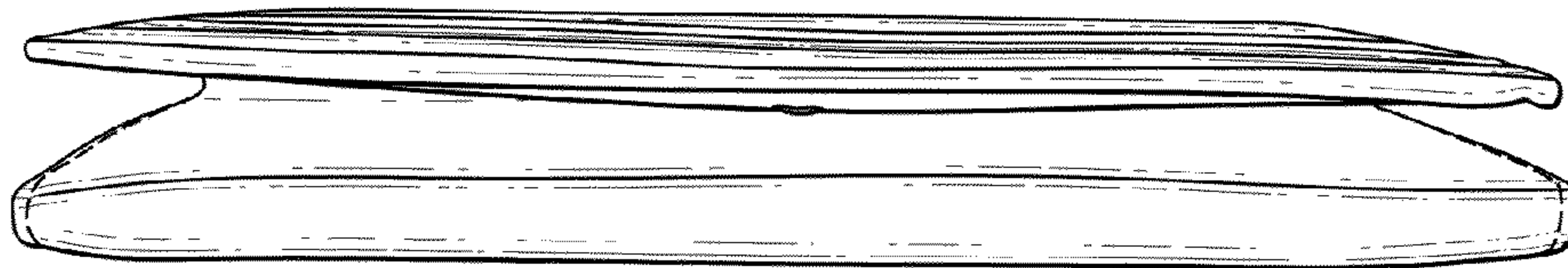

FIG. 7

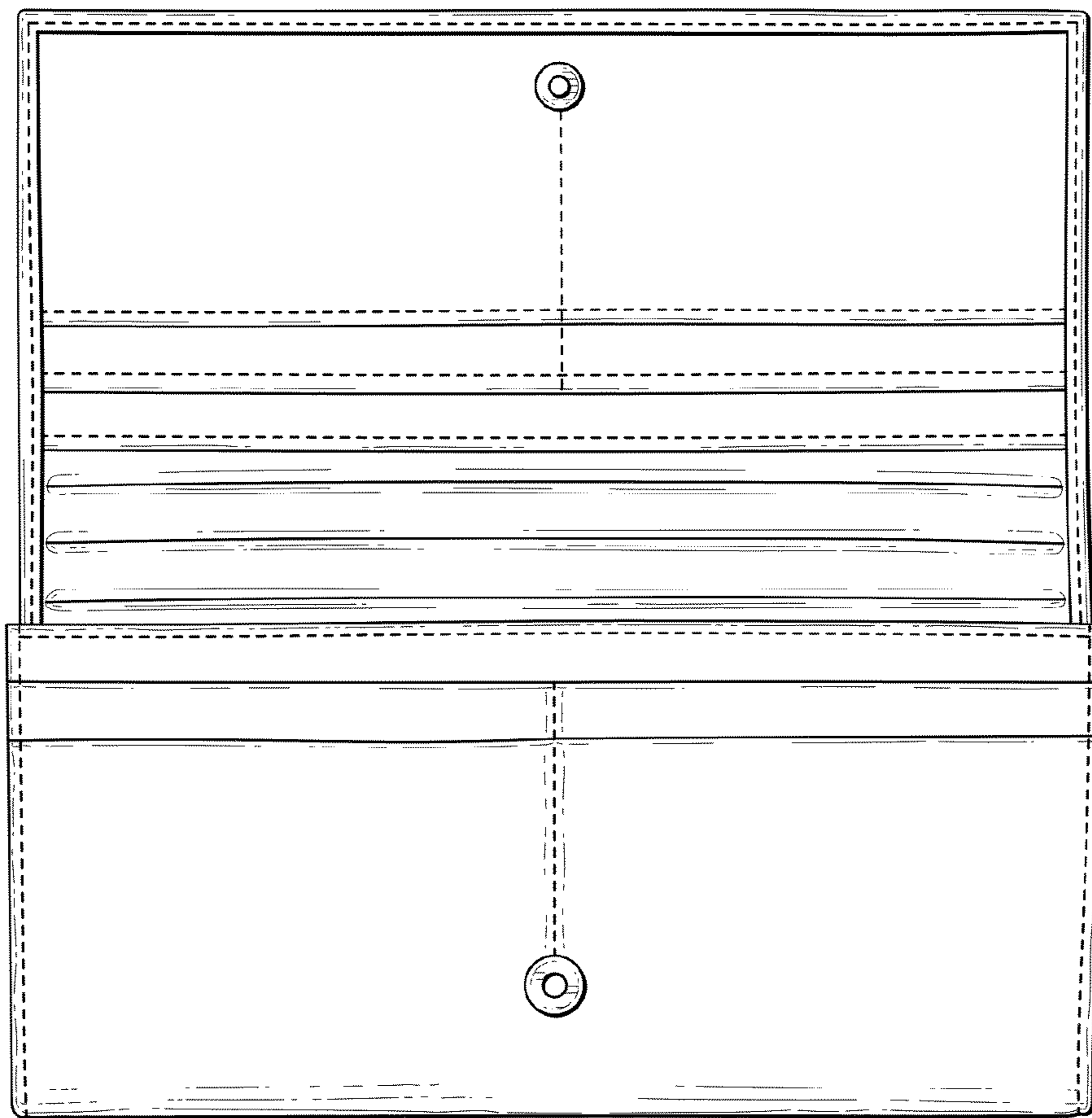

FIG. 8