



US00D703098S

(12) **United States Design Patent**
Quan

(10) **Patent No.:** **US D703,098 S**

(45) **Date of Patent:** **** Apr. 22, 2014**

(54) **ATTACHMENT HARDWARE**

(71) Applicant: **Thule Organization Solutions, Inc.**,
Longmont, CO (US)

(72) Inventor: **Topping Quan**, Kowloon Bay (CN)

(73) Assignee: **Thule Organization Solutions, Inc.**,
Longmont, CO (US)

(**) Term: **14 Years**

(21) Appl. No.: **29/460,293**

(22) Filed: **Jul. 9, 2013**

(51) **LOC (10) Cl.** **02-07**

(52) **U.S. Cl.**
USPC **D11/218**

(58) **Field of Classification Search**
USPC D11/1-2, 200-201, 206-210, 214-218;
24/163 R, 169-171, 173, 177-179, 191,
24/194-195, 197, 200, 614-616, 625, 198
See application file for complete search history.

(56) **References Cited**

U.S. PATENT DOCUMENTS

D183,959 S * 11/1958 Burnham D11/218
D568,785 S * 5/2008 Yang et al. D11/218
D619,497 S * 7/2010 Paik D11/218

* cited by examiner

Primary Examiner — Ralf Seifert

(74) *Attorney, Agent, or Firm* — Sheridan Ross P.C.

(57) **CLAIM**

The ornamental design for attachment hardware, as shown and described.

DESCRIPTION

FIG. 1 is a front perspective view of the attachment hardware; FIG. 2 is a top plan view thereof; FIG. 3 is a front elevation view thereof; FIG. 4 is a right elevation view thereof; FIG. 5 is a left elevation view thereof; FIG. 6 is a rear elevation view thereof; FIG. 7 is a bottom plan view thereof; and, FIG. 8 is a front perspective view with a strap provided therethrough.

The broken lines illustrate environment and are included for the purpose of illustrating unclaimed features of the design.

1 Claim, 3 Drawing Sheets

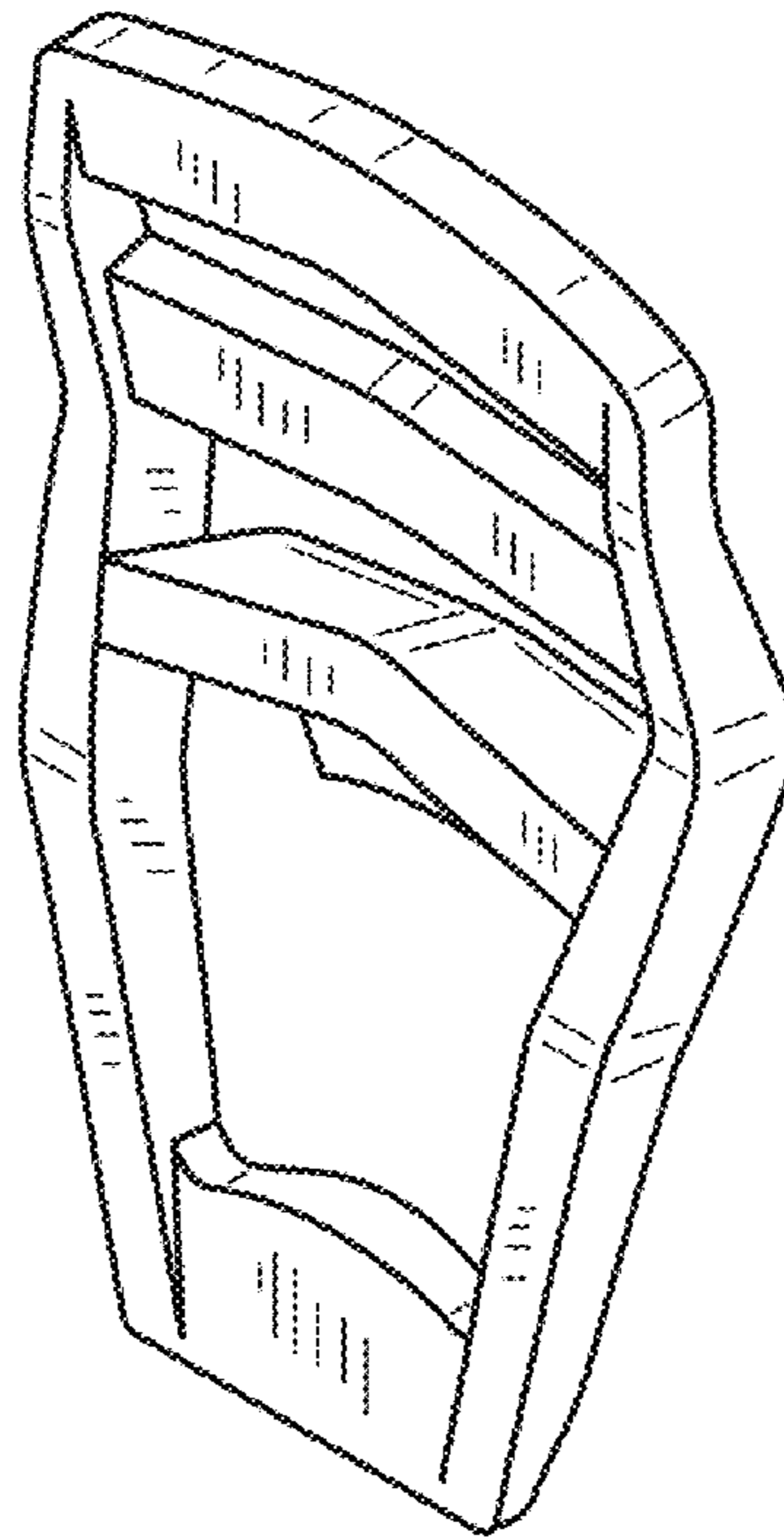

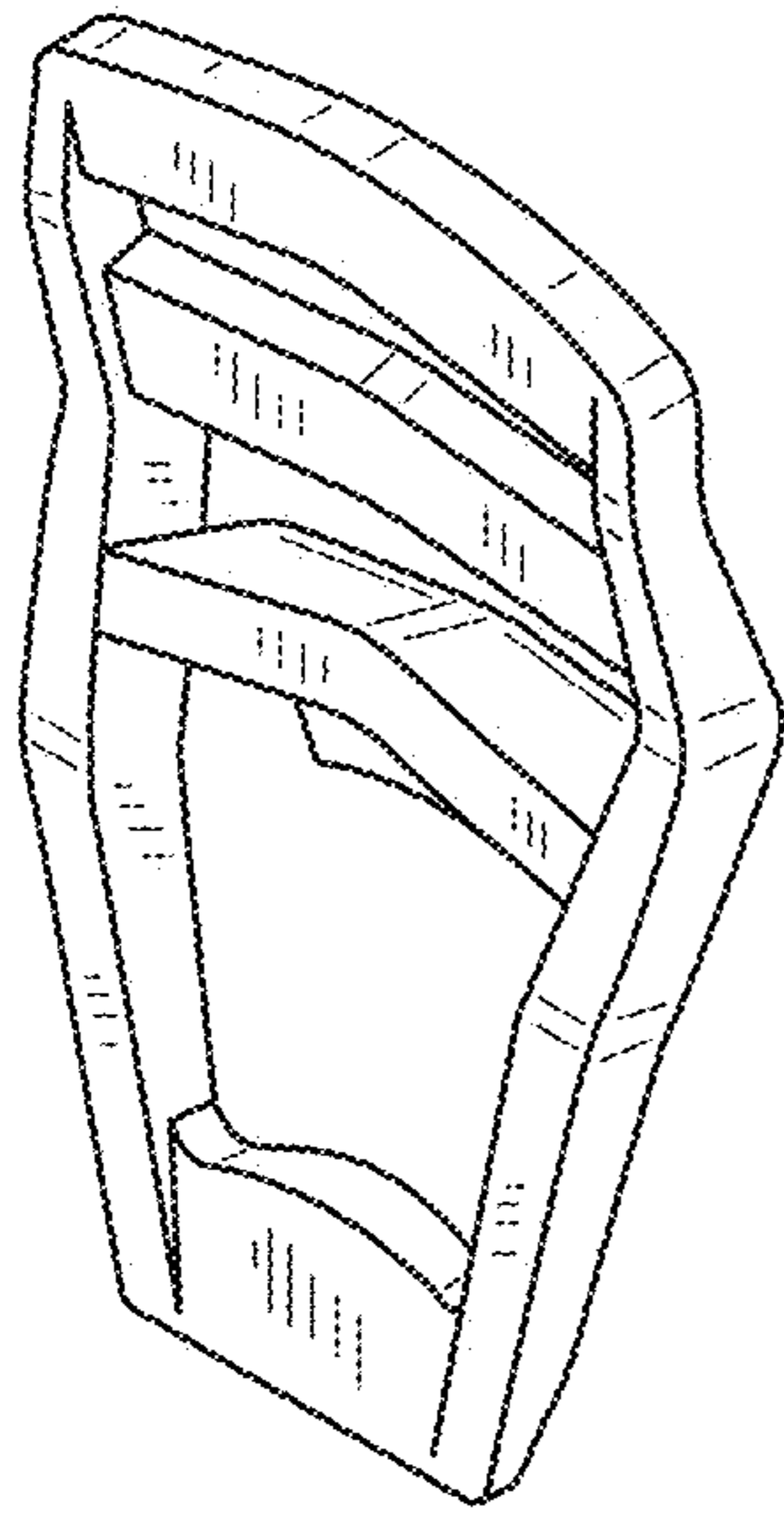

FIG. 1

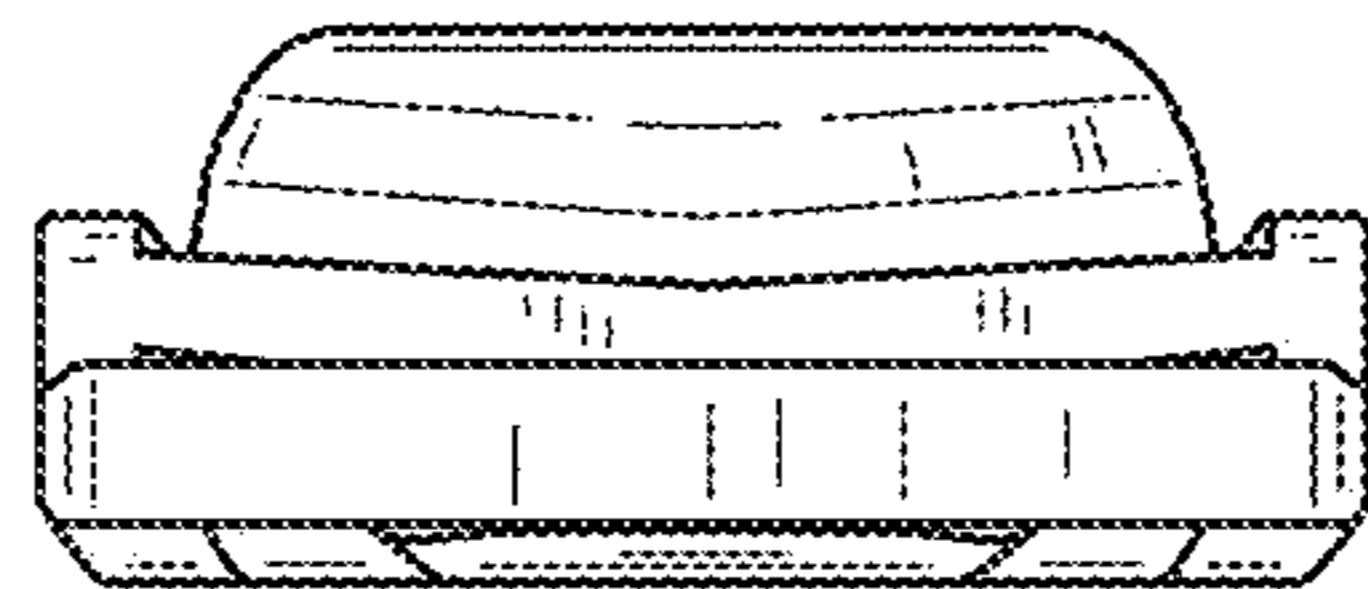

FIG. 2

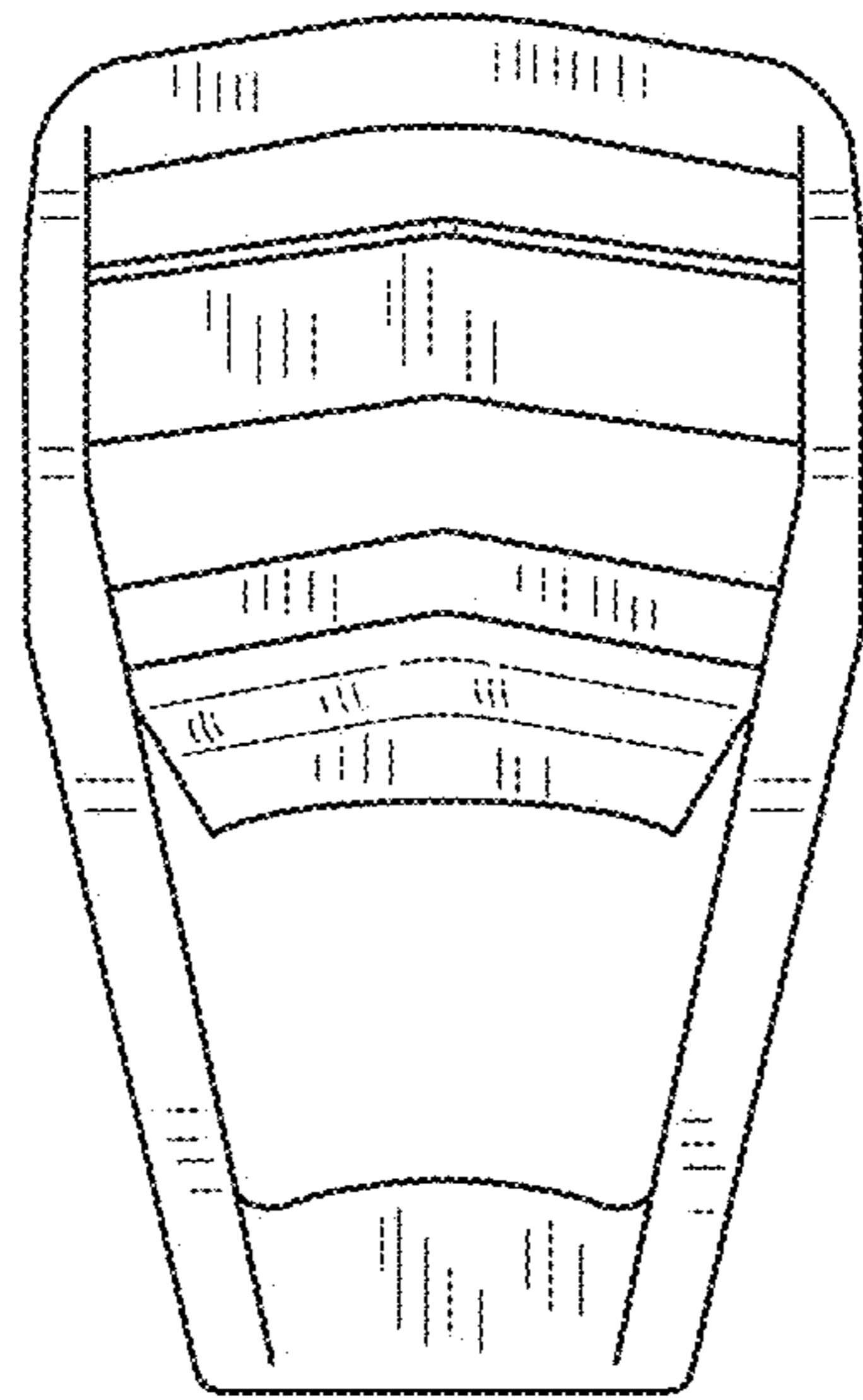

FIG. 3

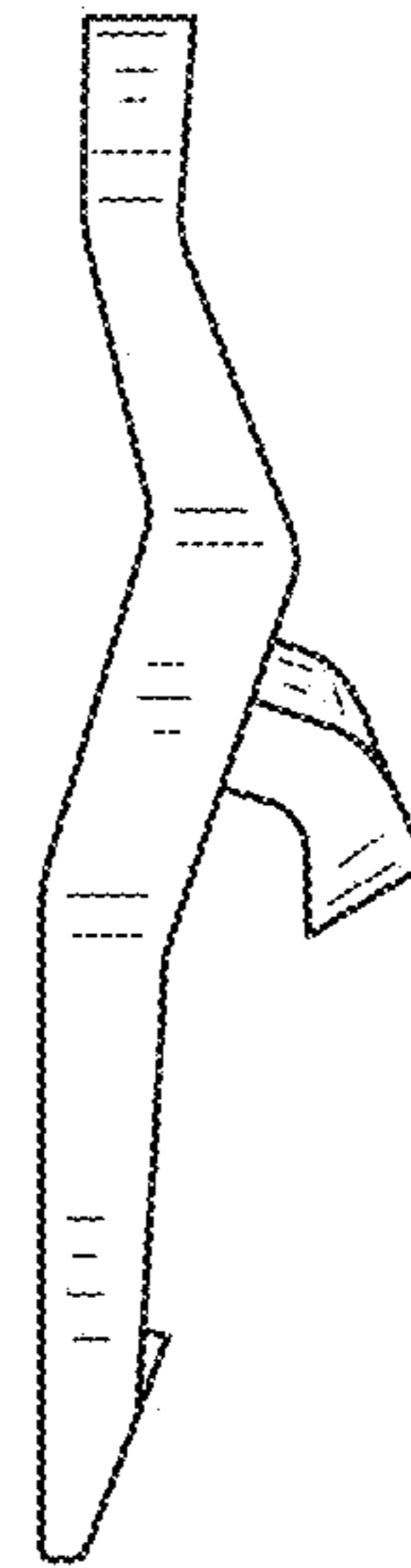

FIG. 4

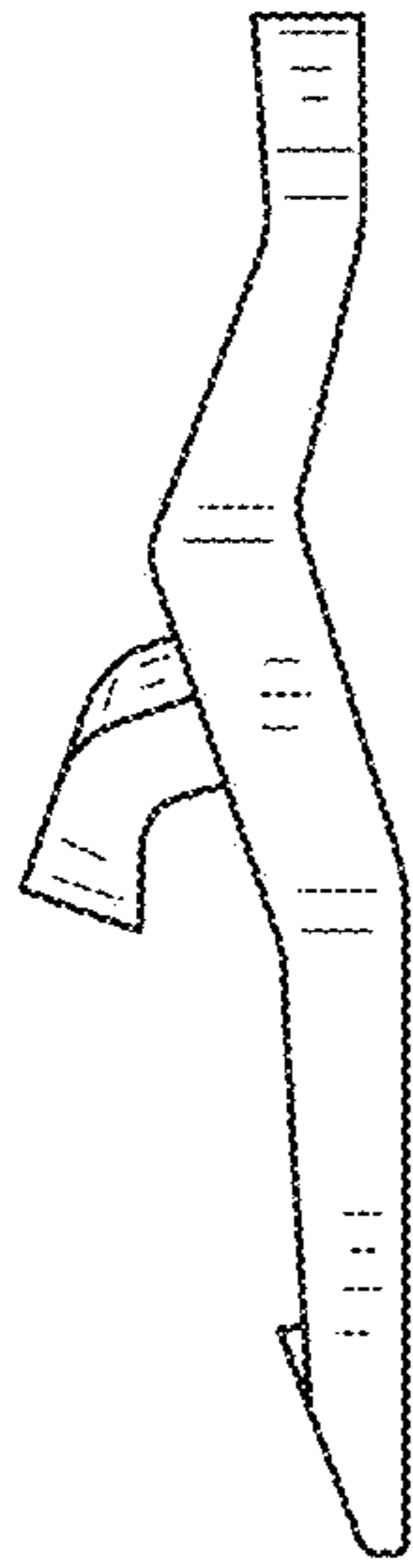

FIG. 5

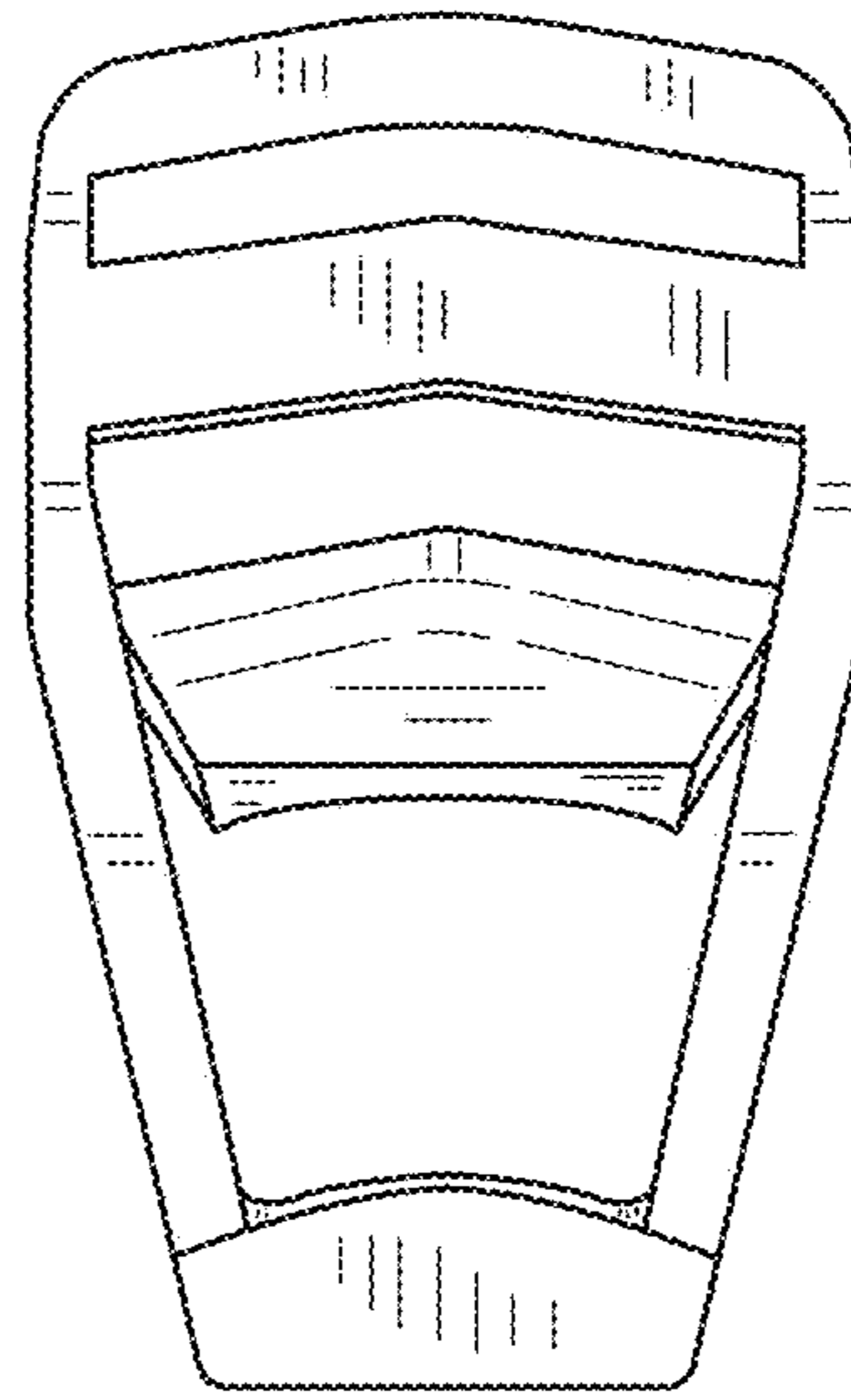

FIG. 6

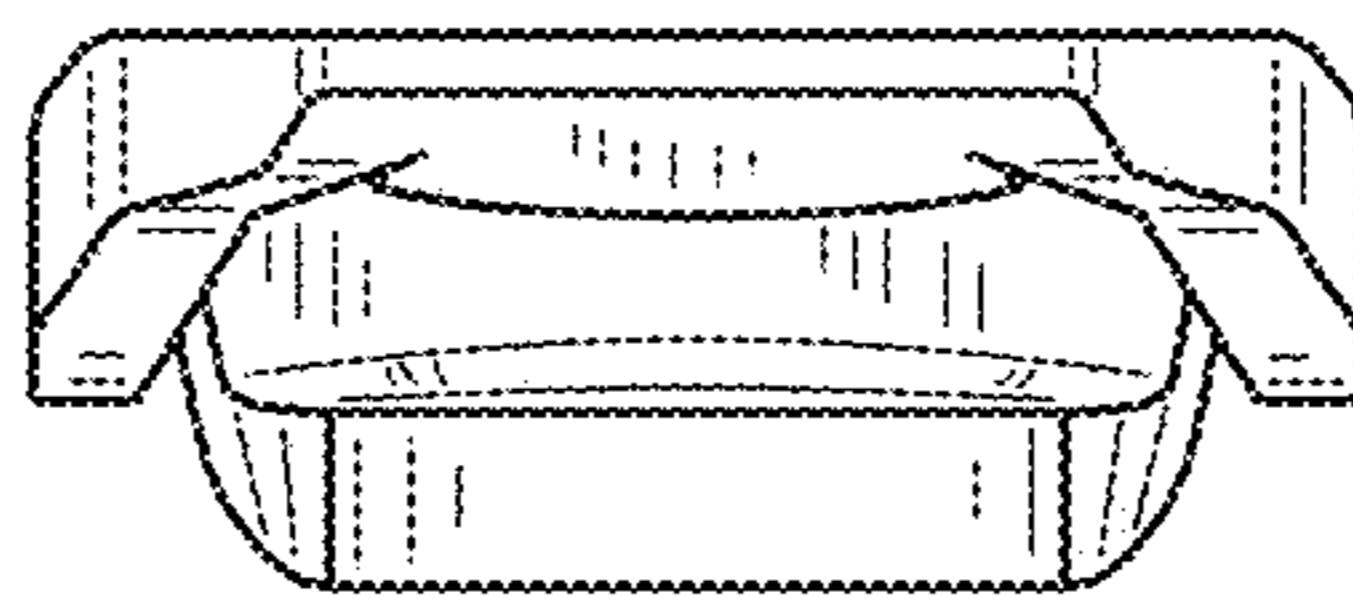

FIG. 7

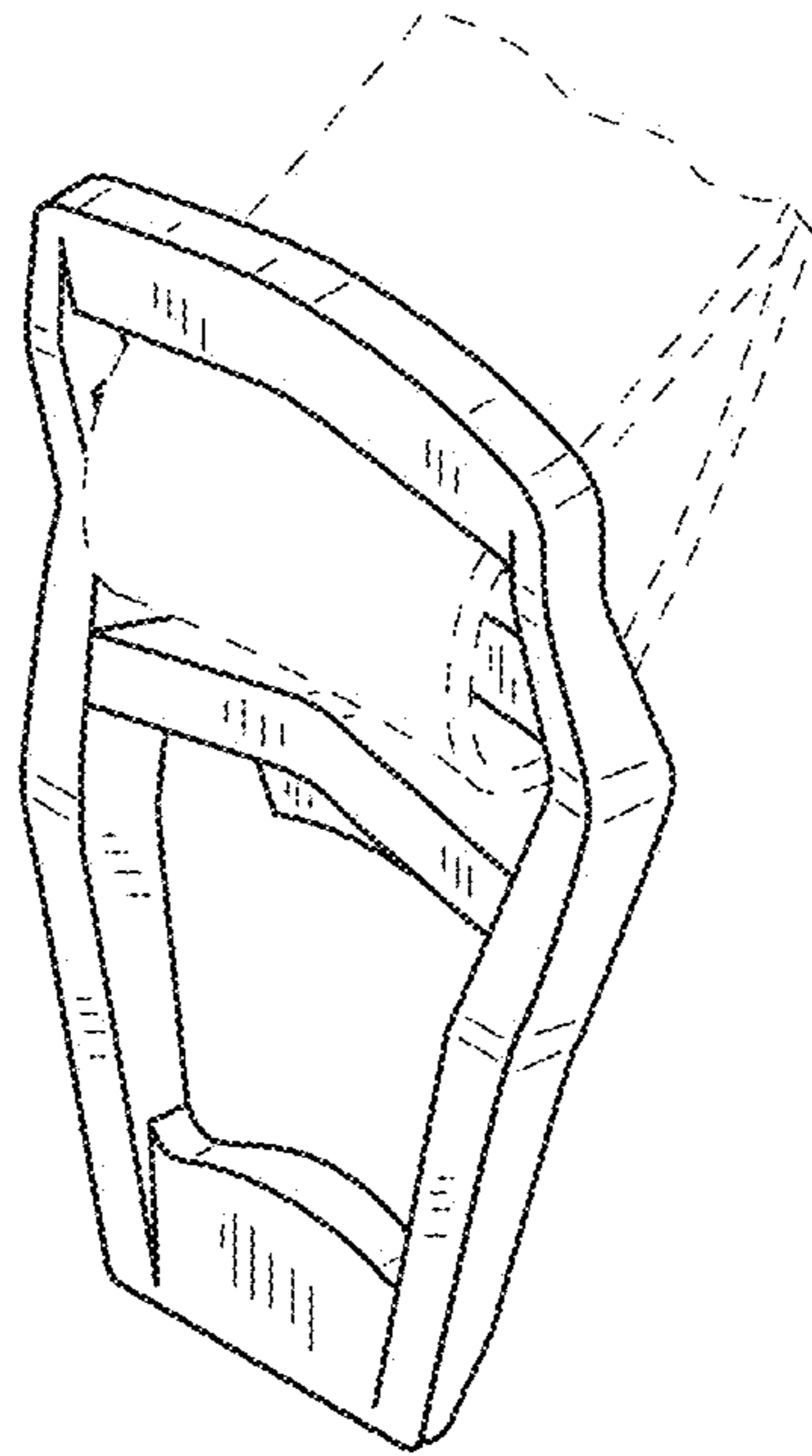

FIG.8