



US00D703093S

(12) **United States Design Patent**
Chamy

(10) **Patent No.:** **US D703,093 S**

(45) **Date of Patent:** **** Apr. 22, 2014**

(54) **OVERLAPPING DECORATIVE PANEL SET**

(76) **Inventor:** **Dimitry Saïd Chamy**, Coconut Grove,
FL (US)

(**) **Term:** **14 Years**

(21) **Appl. No.:** **29/431,571**

(22) **Filed:** **Sep. 9, 2012**

(51) **LOC (10) Cl.** **11-02**

(52) **U.S. Cl.**
USPC **D11/131**

(58) **Field of Classification Search**
USPC D11/131–133, 157; D6/300–314, 332,
D6/352, 553; D20/29; 40/600, 661, 700,
40/711, 735, 738, 745, 765, 780, 790, 791,
40/798, 799; 273/348.4, 372; 715/735,
715/754; 52/27, 391; 434/73, 80; 248/489
See application file for complete search history.

(56) **References Cited**

U.S. PATENT DOCUMENTS

4,741,534	A *	5/1988	Rogahn	273/157 R
5,505,620	A *	4/1996	Barlett	439/73
6,339,429	B1 *	1/2002	Schug	345/589
6,390,648	B1 *	5/2002	Privas et al.	362/276
6,820,853	B1 *	11/2004	DuBarry	248/489
6,889,457	B2 *	5/2005	Boddie	40/600
D541,090	S *	4/2007	Olofson	D6/553
7,512,891	B2 *	3/2009	Gnanamgari et al.	715/754

D612,763	S *	3/2010	Muller	D11/131
D627,679	S *	11/2010	Muller	D11/131
8,161,700	B2 *	4/2012	Scalise	52/391
8,245,453	B2 *	8/2012	Struthers et al.	52/27
2003/0121195	A1 *	7/2003	Moon	40/737
2005/0155266	A1 *	7/2005	Pupava-Felty et al.	40/729
2005/0183020	A1 *	8/2005	Gnanamgari et al.	715/735
2009/0317599	A1 *	12/2009	Heuman	428/189

* cited by examiner

Primary Examiner — T. Chase Nelson

Assistant Examiner — Michelle E Wilson

(74) *Attorney, Agent, or Firm* — QuickPatents; Kevin Prince

(57) **CLAIM**

I claim the ornamental design for an overlapping decorative panel set, as shown and described.

DESCRIPTION

FIG. 1 is a perspective view of an overlapping decorative panel set, showing my new design;
FIG. 2 is an exploded perspective view thereof;
FIG. 3 is a scaled-down top plan view thereof, the rear elevational view being a mirror image thereof;
FIG. 4 is a top plan view of FIG. 1;
FIG. 5 is a rear elevational view of FIG. 1;
FIG. 6 is an enlarged right-side elevational view thereof;
FIG. 7 is an enlarged left-side elevational view thereof;
FIG. 8 is an enlarged top plan view thereof; and,
FIG. 9 is an enlarged bottom plan view thereof.
The broken lines showing a wall in FIG. 1 depict environmental matter and form no part of the claimed design.

1 Claim, 4 Drawing Sheets

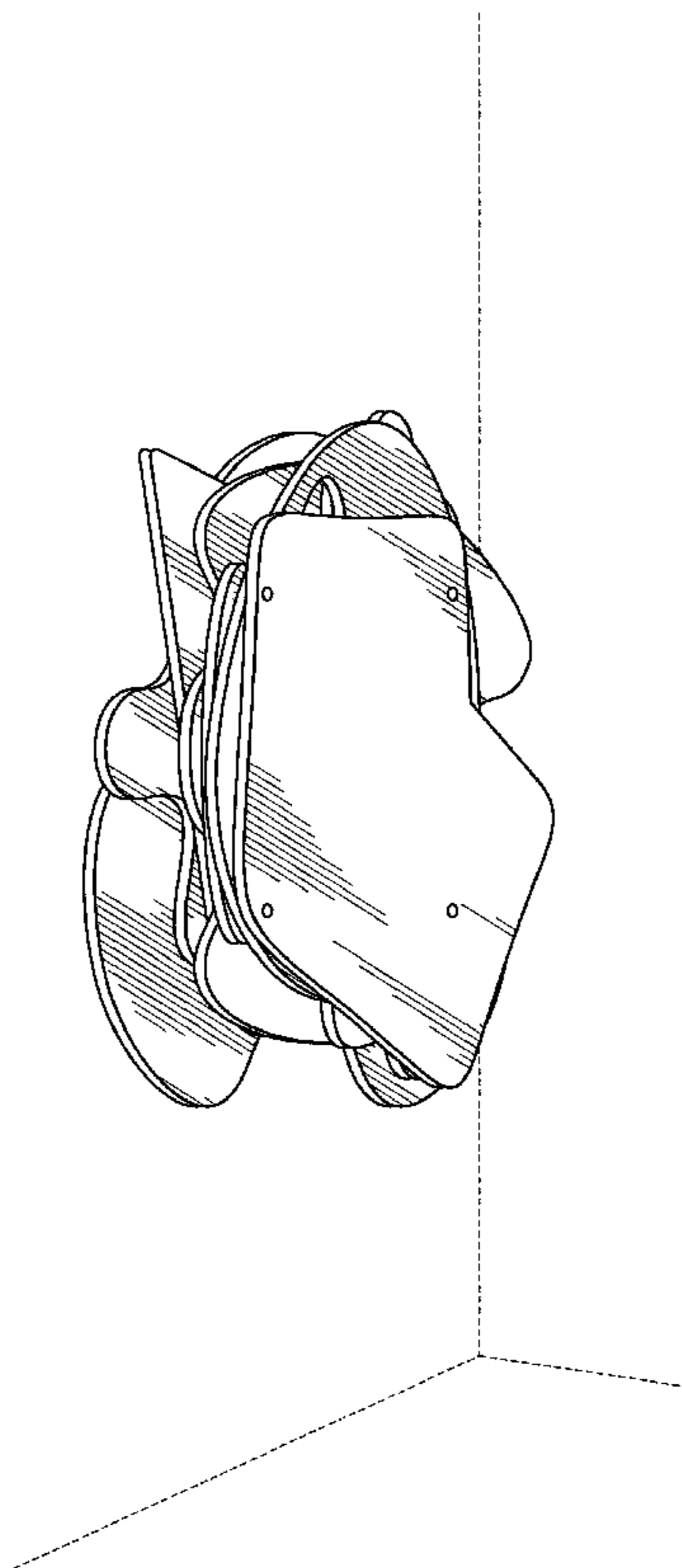

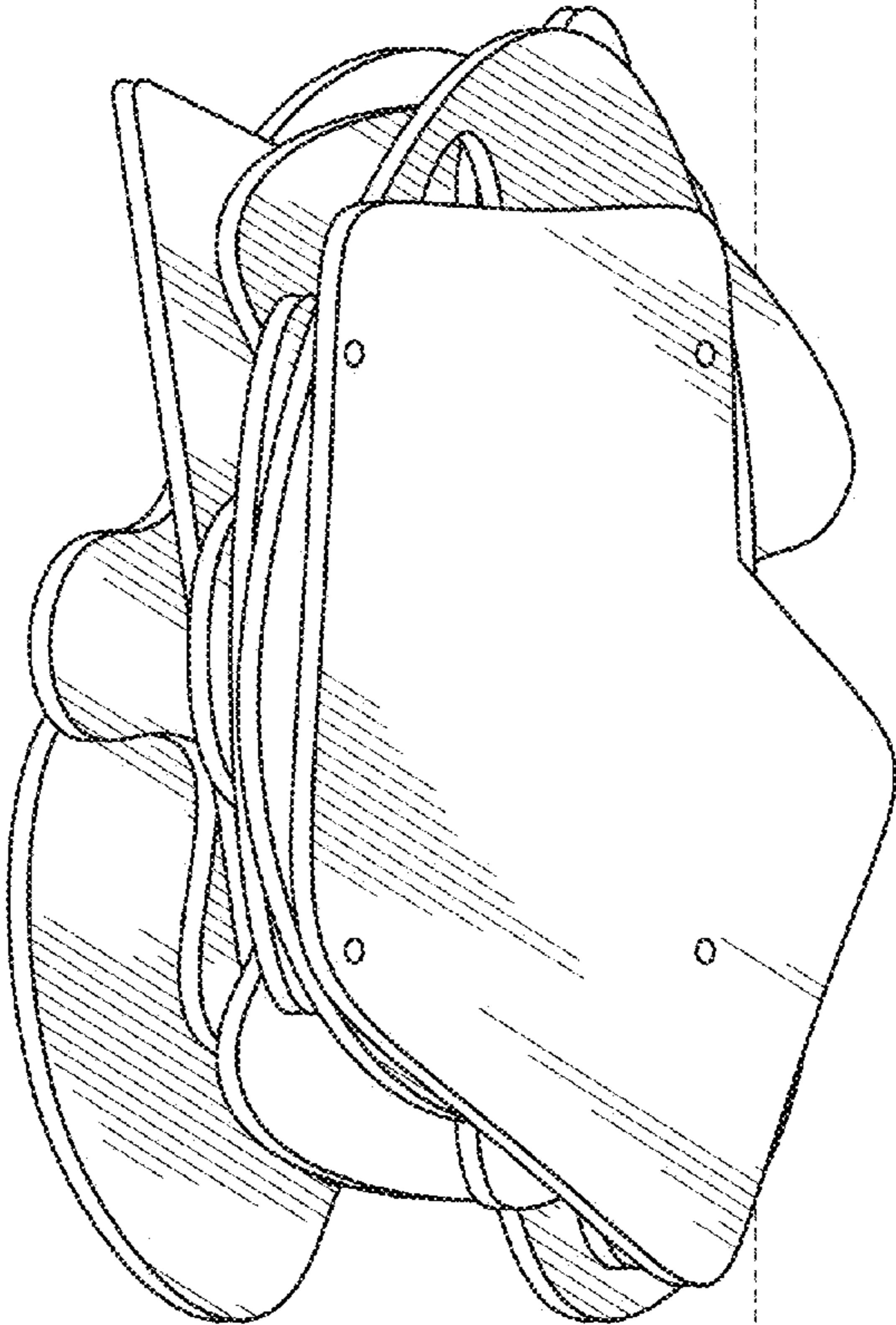

FIG. 1

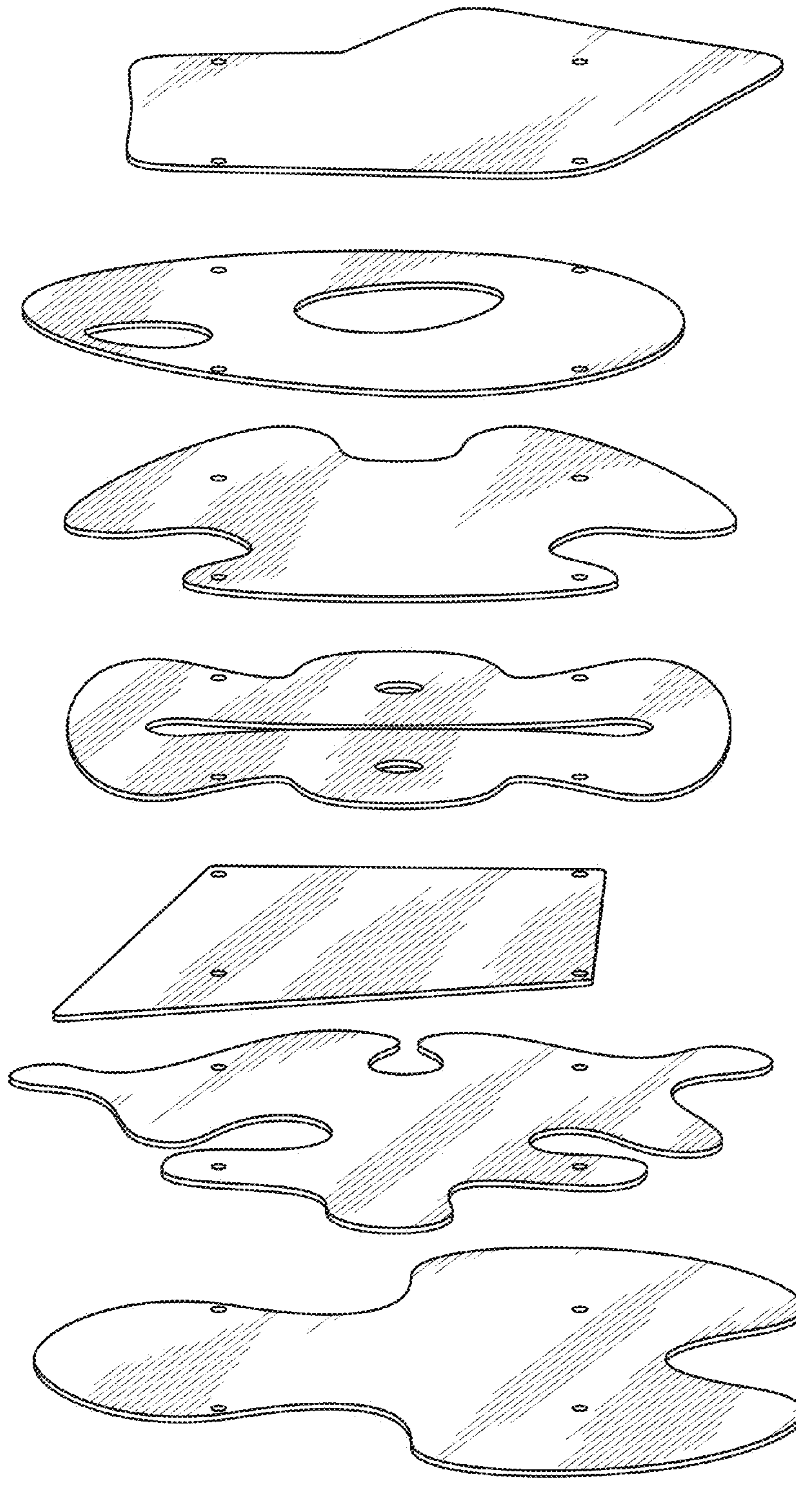

FIG. 2

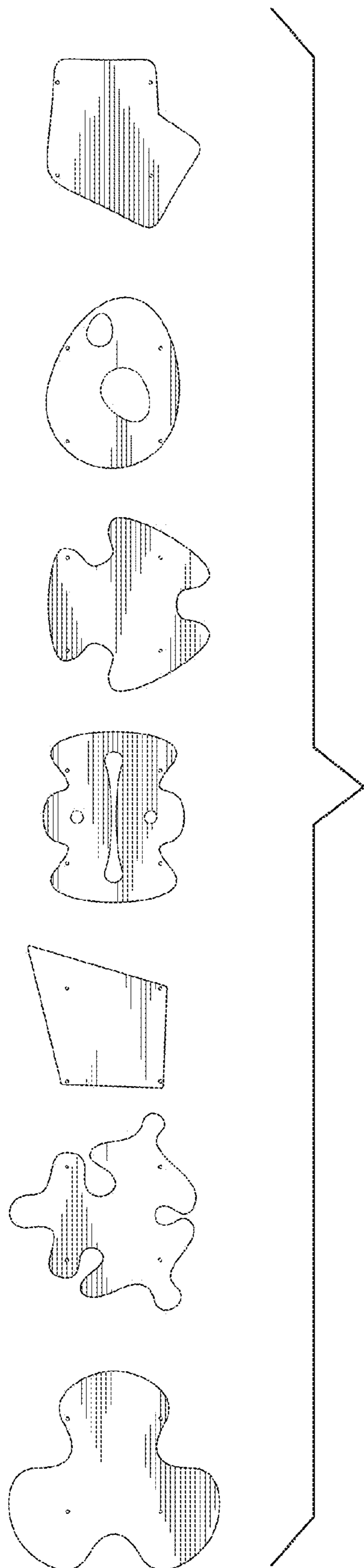

FIG. 3

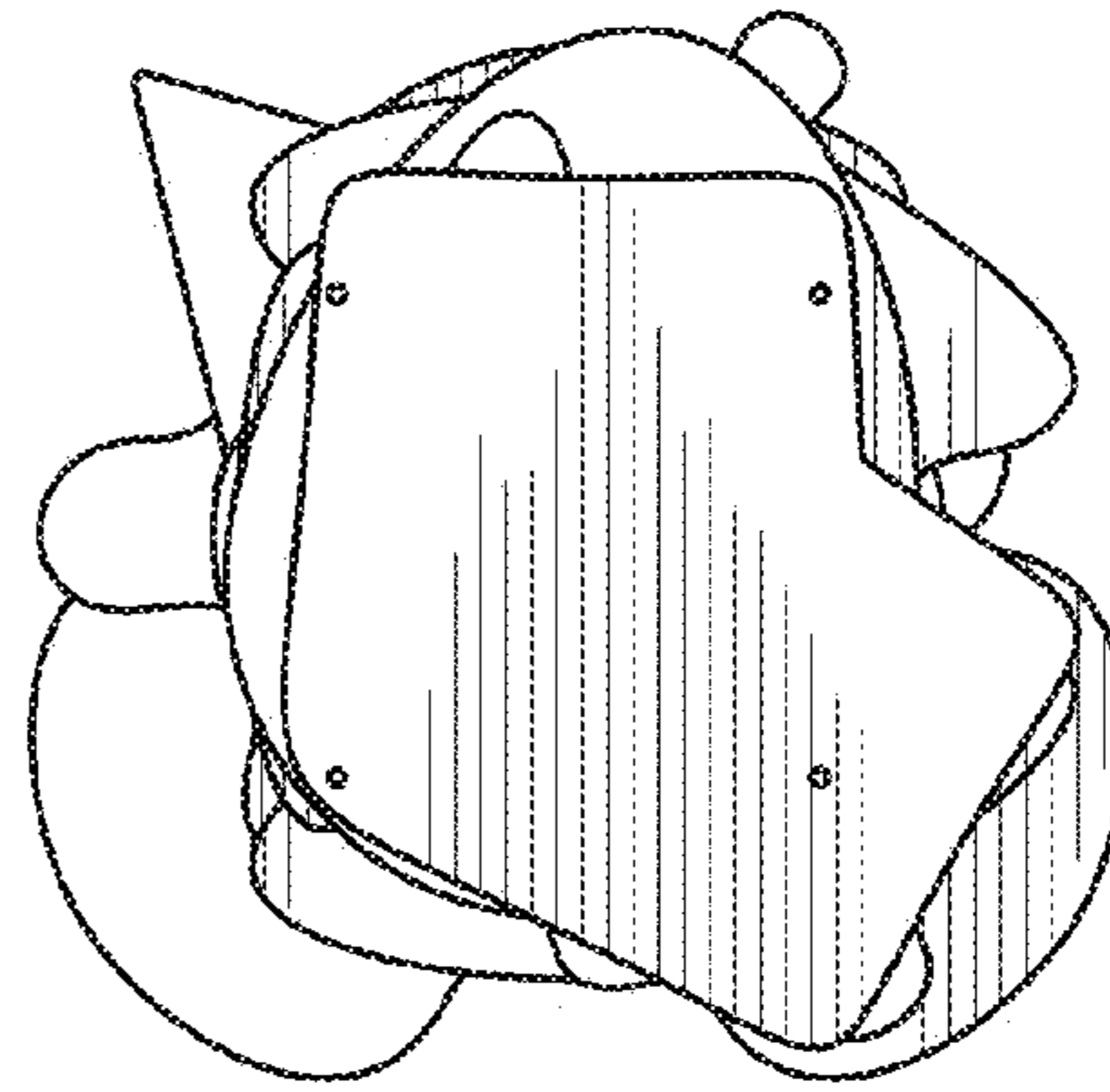

FIG. 4

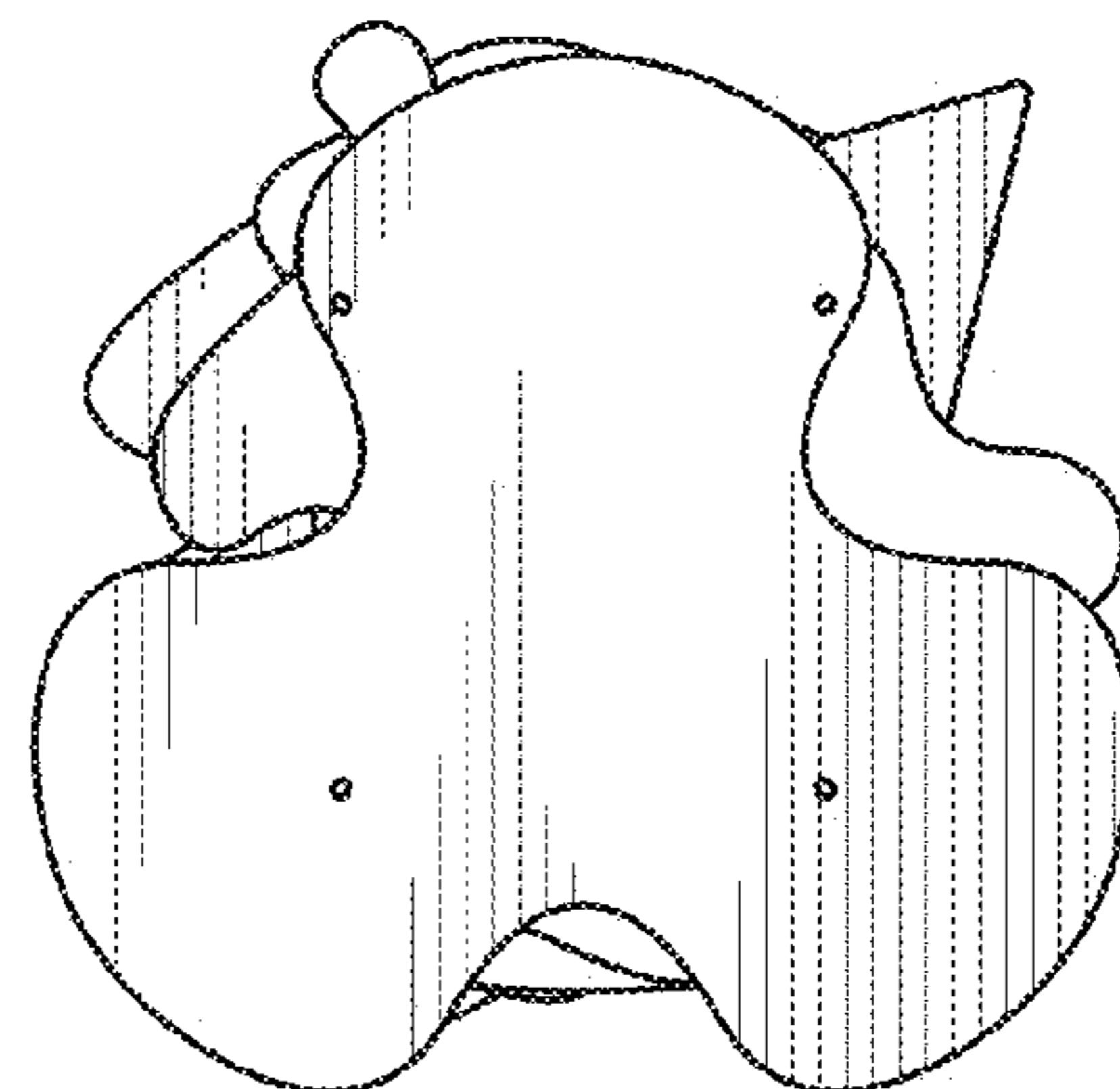

FIG. 5

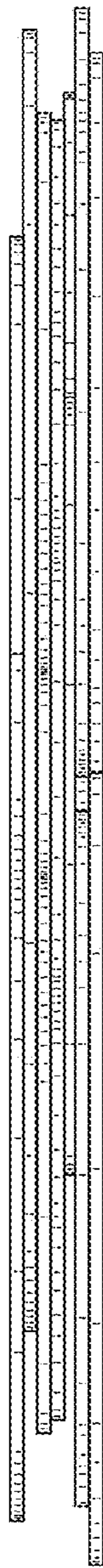

FIG. 6

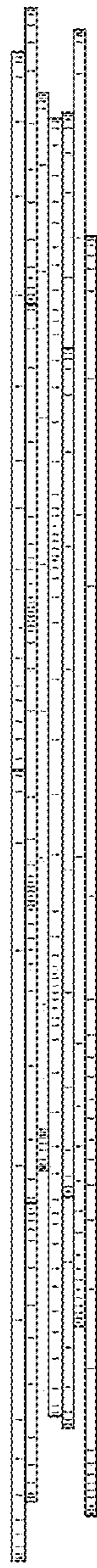

FIG. 7

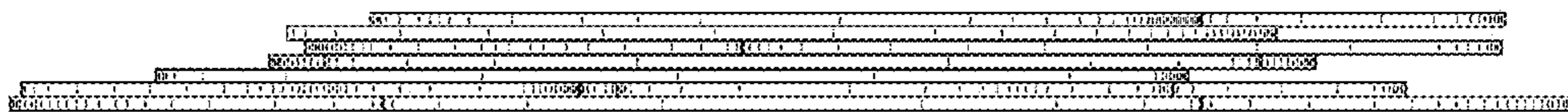

FIG. 8

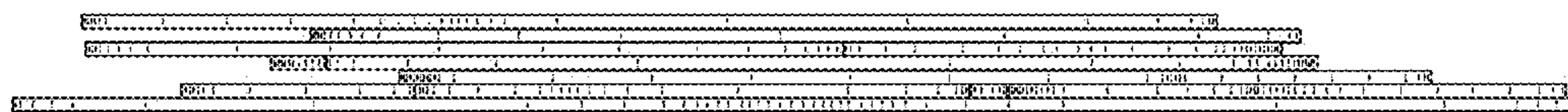

FIG. 9