



US00D703055S

(12) **United States Design Patent**  
**Park**

(10) **Patent No.:** **US D703,055 S**

(45) **Date of Patent:** **\*\* Apr. 22, 2014**

(54) **COSMETIC CONTAINER**

(71) Applicant: **Amorepacific Corporation**, Seoul (KR)

(72) Inventor: **Kyung Mi Park**, Seoul (KR)

(\*\*) Term: **14 Years**

(21) Appl. No.: **29/462,201**

(22) Filed: **Jul. 31, 2013**

(30) **Foreign Application Priority Data**

Feb. 1, 2013 (KR) ..... 30-2013-0005713

(51) **LOC (10) Cl.** ..... **09-01**

(52) **U.S. Cl.**  
USPC ..... **D9/504**; D9/454; D9/551

(58) **Field of Classification Search**  
USPC ..... D9/435, 454, 500, 502-505, 516, 529,  
D9/549, 552, 558, 571, 682, 686-692;  
D3/203.2, 203.3, 205, 302; D28/73,  
D28/76-78, 81-82; 215/379, 381; 220/660,  
220/662, 665, 675

See application file for complete search history.

(56) **References Cited**

**U.S. PATENT DOCUMENTS**

D324,997 S \* 3/1992 Jones ..... D9/529  
D391,162 S \* 2/1998 Kokenge ..... D9/504  
5,846,089 A \* 12/1998 Weiss et al. .... 434/365  
D411,747 S \* 6/1999 Kokenge et al. .... D9/503  
D424,943 S \* 5/2000 Kokenge et al. .... D9/504  
D522,695 S \* 6/2006 Desdoigts ..... D28/82

D561,943 S \* 2/2008 Desdoigts ..... D28/82  
D615,868 S \* 5/2010 Rodriguez et al. .... D9/529  
D640,925 S \* 7/2011 Rodriguez et al. .... D9/529  
D641,245 S \* 7/2011 Rodriguez et al. .... D9/529  
D645,749 S \* 9/2011 Lee ..... D9/504  
D645,750 S \* 9/2011 Lee ..... D9/504  
D662,822 S \* 7/2012 Morais et al. .... D9/504  
D688,138 S \* 8/2013 Kim ..... D9/690  
D692,773 S \* 11/2013 Kim ..... D9/690

\* cited by examiner

*Primary Examiner* — Dana L Meyrow

(74) *Attorney, Agent, or Firm* — Ohlandt Greeley Ruggiero & Perle L.L.P.

(57) **CLAIM**

The ornamental design for a cosmetic container, as shown and described.

**DESCRIPTION**

FIG. 1 is a perspective view of the cosmetic container of the present disclosure;  
FIG. 2 is a front elevation view of the cosmetic container shown in FIG. 1;  
FIG. 3 is a rear elevation view of the cosmetic container shown in FIG. 1;  
FIG. 4 is a left side elevation view of the cosmetic container shown in FIG. 1;  
FIG. 5 is a right side elevation view of the cosmetic container shown in FIG. 1;  
FIG. 6 is a top plan view of the cosmetic container shown in FIG. 1; and,  
FIG. 7 is a bottom plan view of the cosmetic container shown in FIG. 1.

**1 Claim, 7 Drawing Sheets**

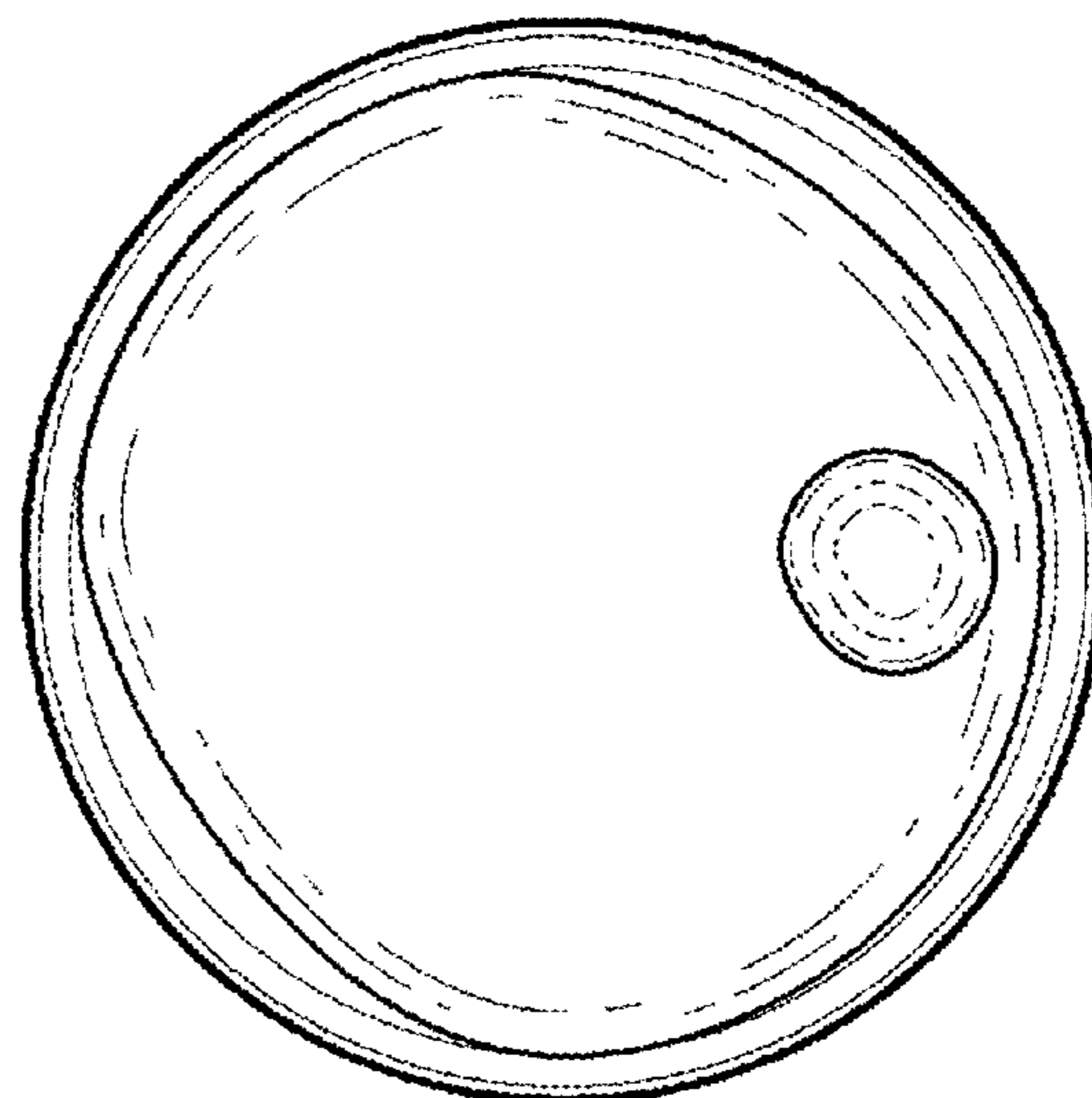
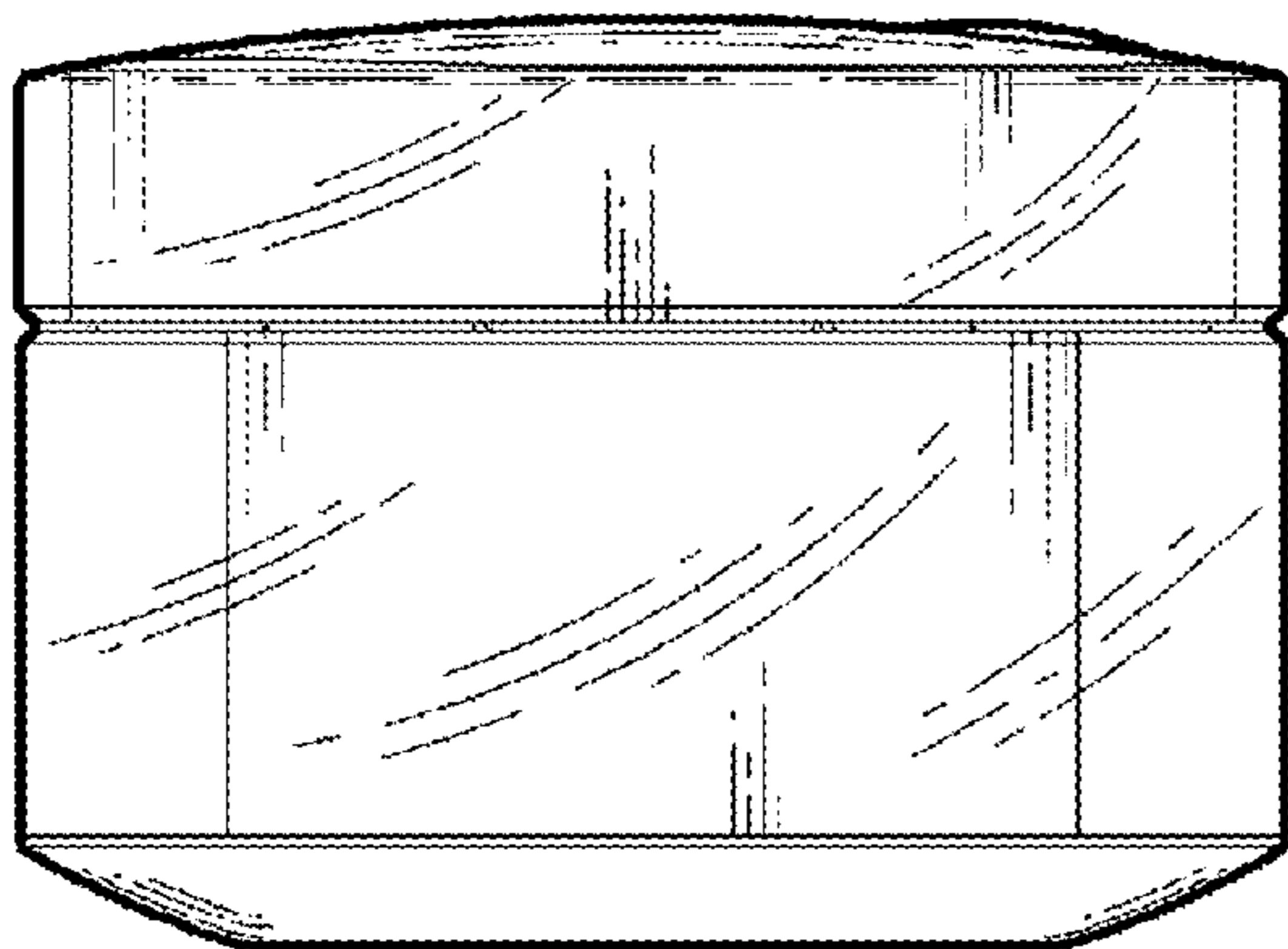

Fig. 1

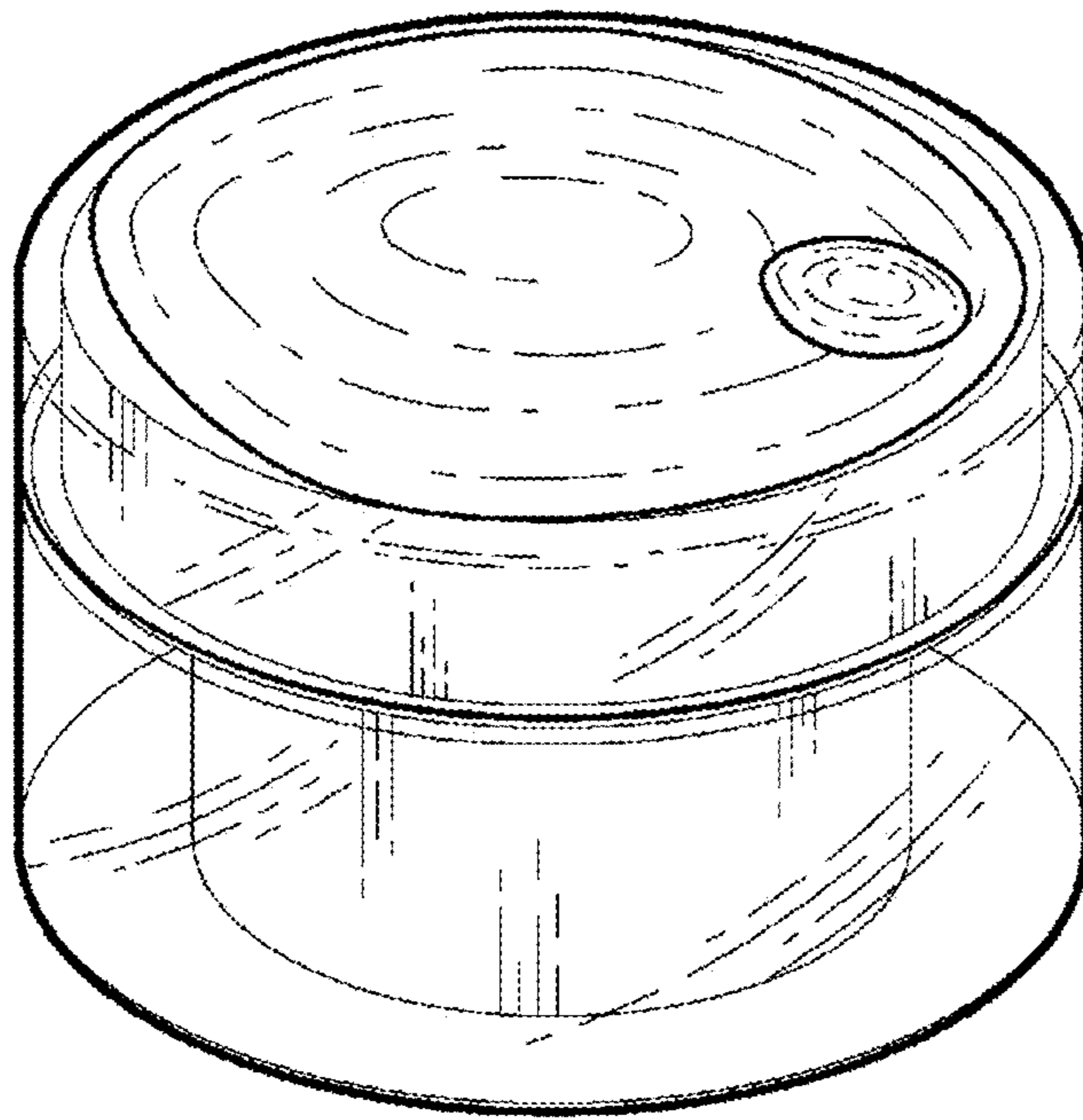

Fig. 2

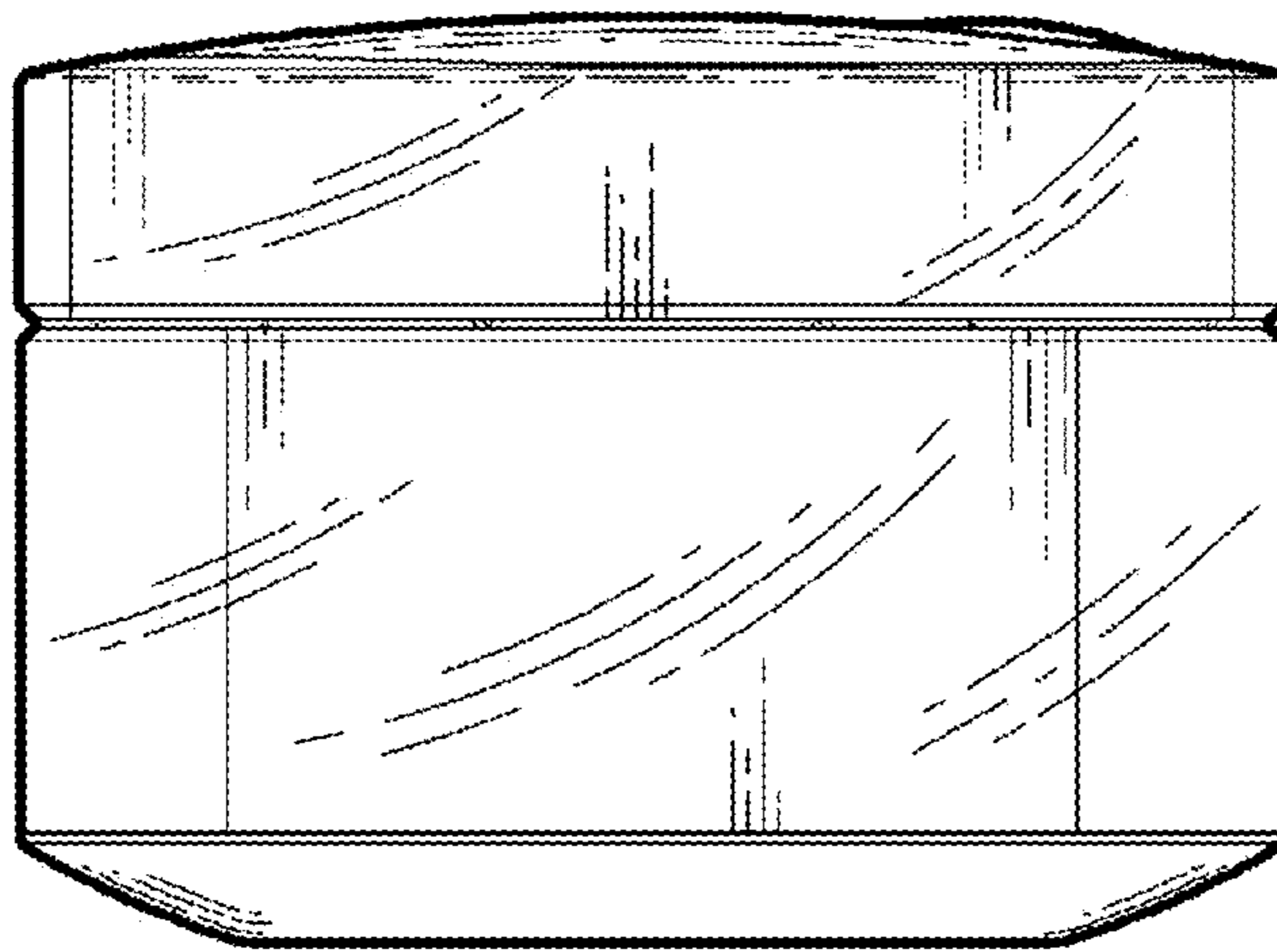

Fig. 3

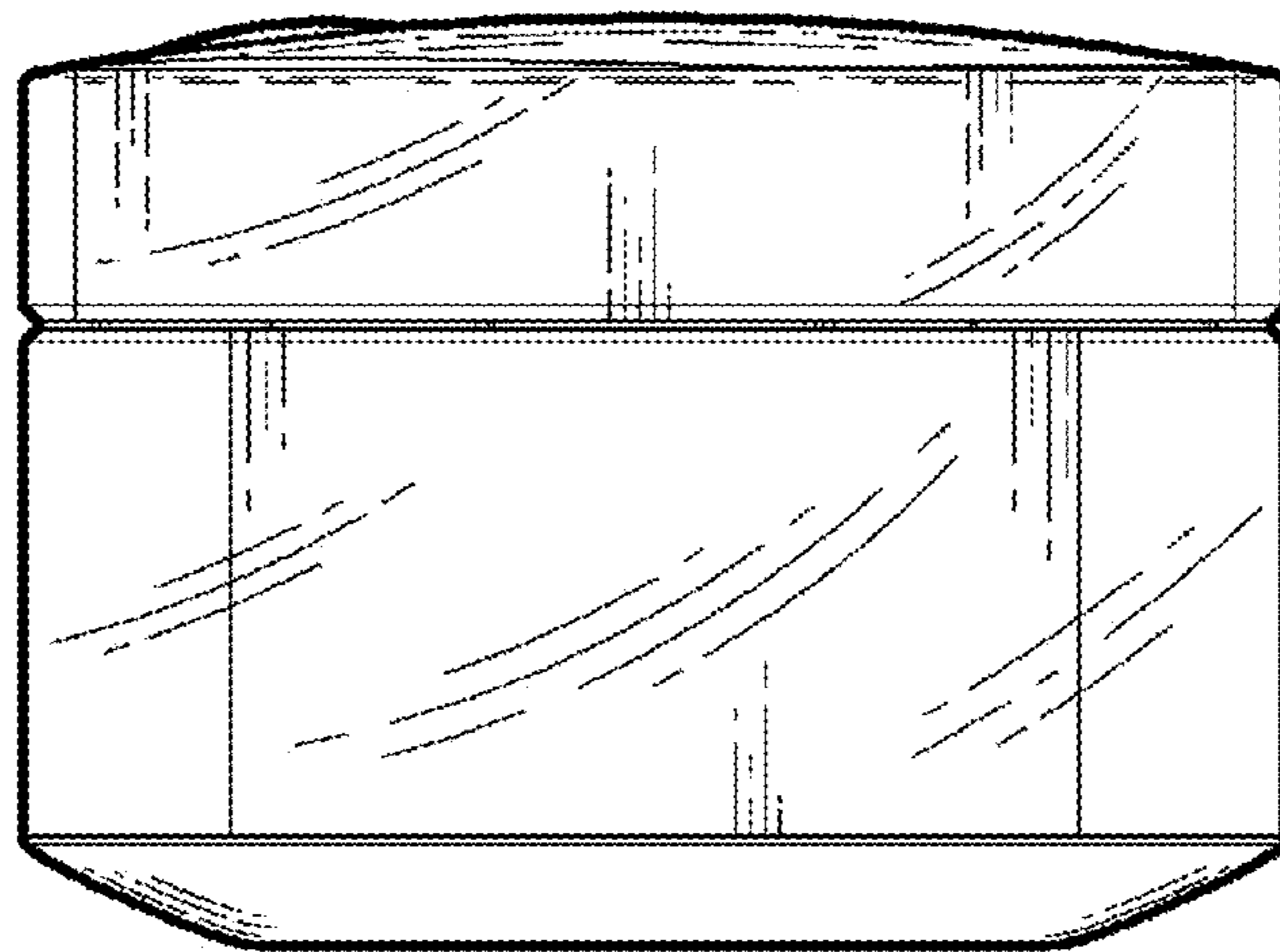

Fig. 4

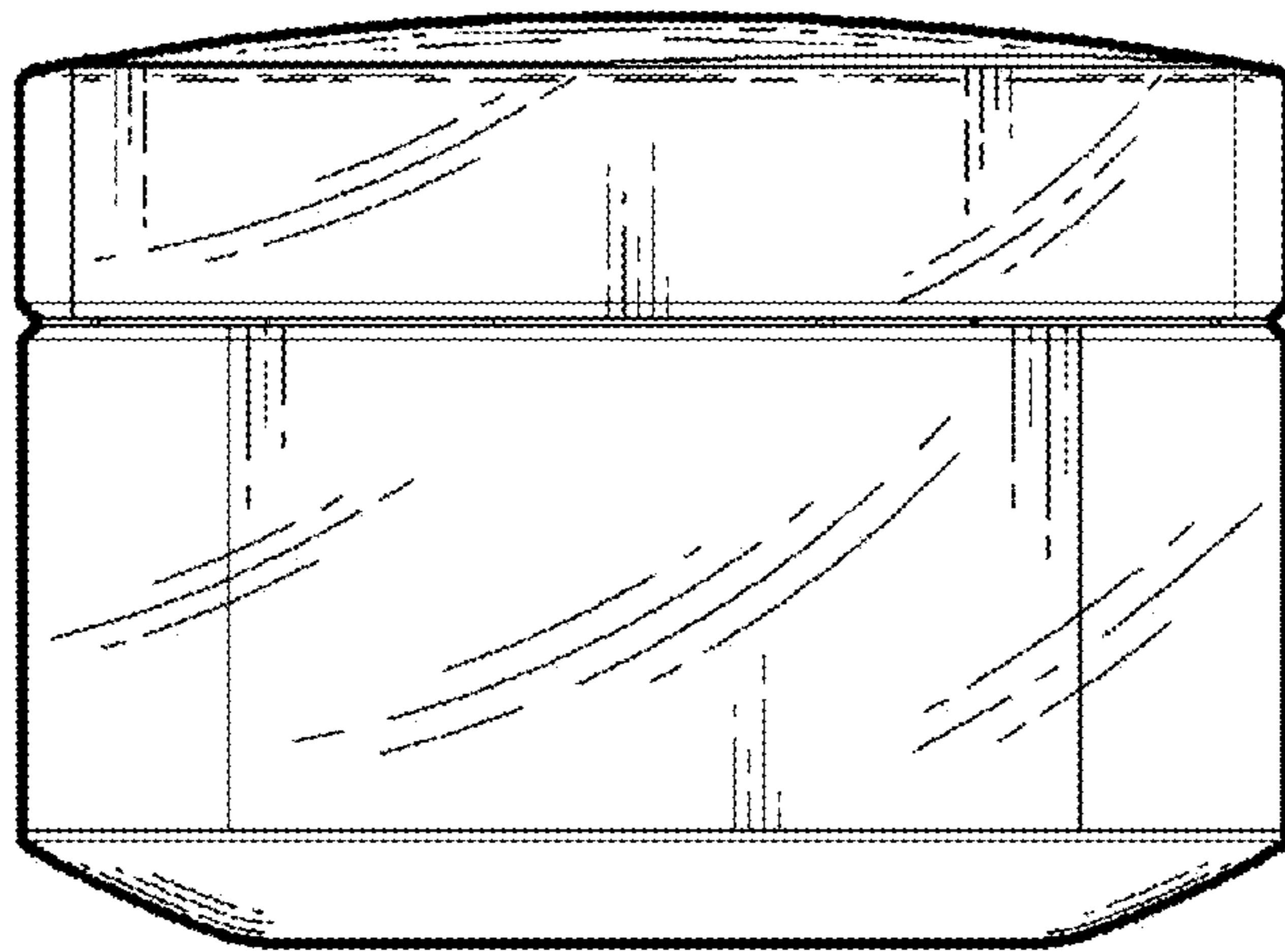

Fig. 5

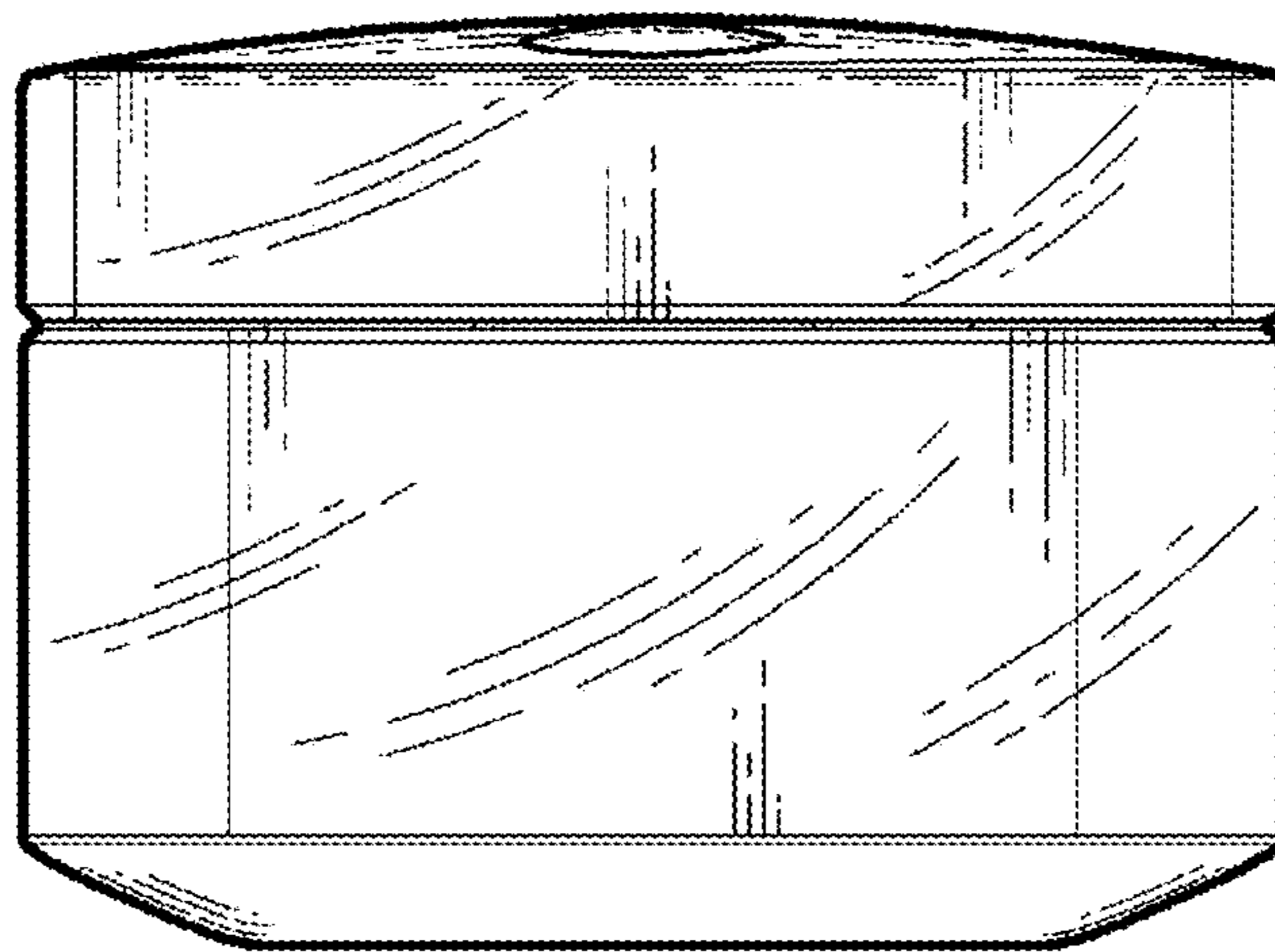

Fig. 6

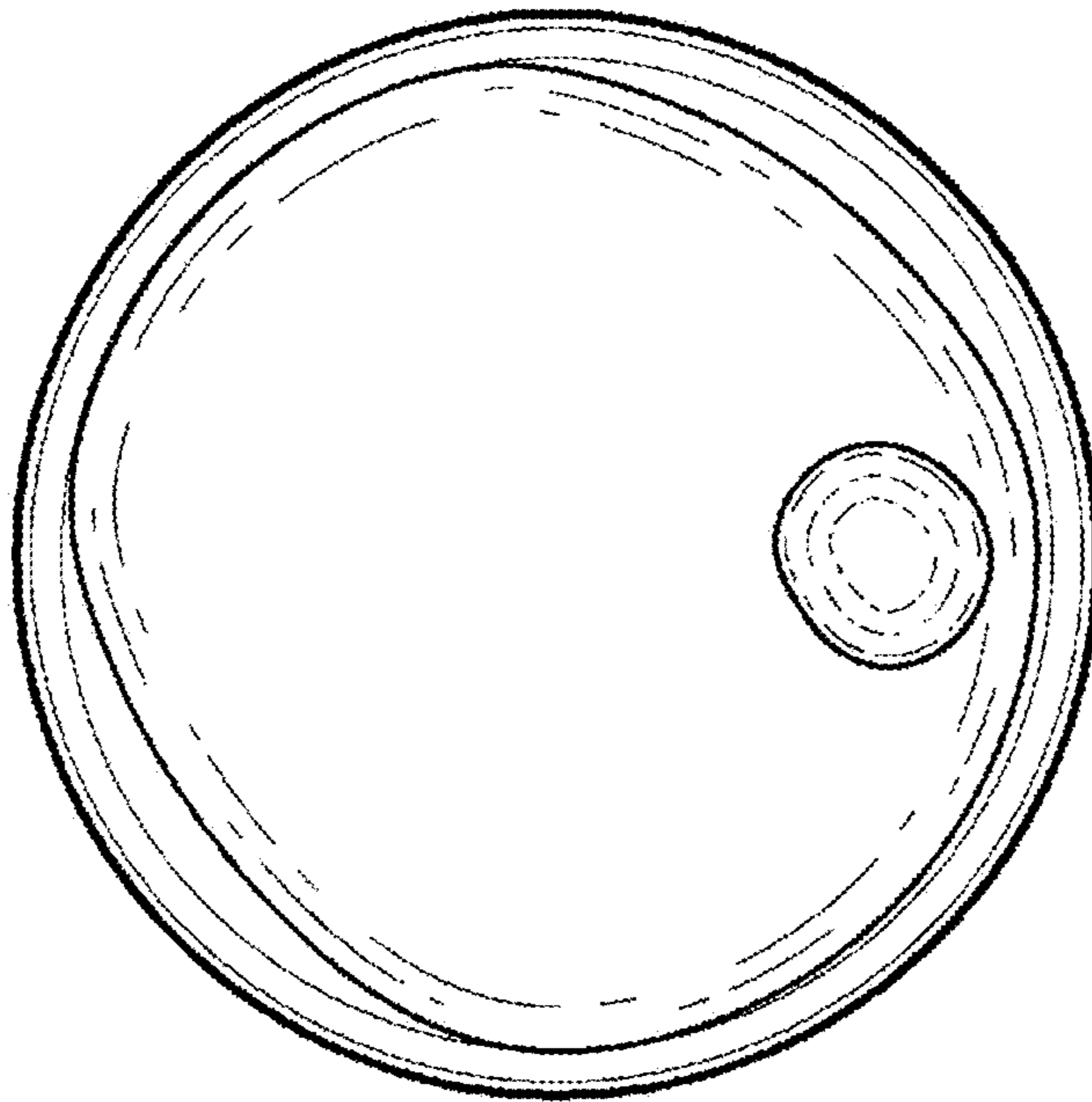

Fig. 7

