



US00D702977S

(12) **United States Design Patent**
Bonneywell

(10) **Patent No.:** **US D702,977 S**

(45) **Date of Patent:** **** Apr. 22, 2014**

(54) **CHAIR**

(71) Applicant: **Boss Design Limited**, West Midlands (GB)

(72) Inventor: **David Stephen Bonneywell**, West Midlands (GB)

(73) Assignee: **Boss Design Limited**, West Midlands (GB)

(**) Term: **14 Years**

(21) Appl. No.: **29/446,157**

(22) Filed: **Feb. 21, 2013**

(30) **Foreign Application Priority Data**

Dec. 12, 2012 (EM) 002151621

(51) **LOC (10) Cl.** **06-01**

(52) **U.S. Cl.**
USPC **D6/716; D6/366**

(58) **Field of Classification Search**
USPC D6/334-336, 364, 365, 366, 367, 374, D6/376, 379, 380, 716, 716.1, 716.2, D6/716.3, 716.4; 297/284.4, 411.4, 297/452.13, 452.21, 452.29, 452.3, 452.56
See application file for complete search history.

(56) **References Cited**

U.S. PATENT DOCUMENTS

D570,624 S * 6/2008 Kang D6/716

D647,738 S * 11/2011 Chen D6/716.1
D668,085 S * 10/2012 Bellin D6/716
2007/0267911 A1* 11/2007 Kinoshita et al. 297/452.56

* cited by examiner

Primary Examiner — Mimoso De

(74) *Attorney, Agent, or Firm* — Design IP

(57) **CLAIM**

The ornamental design for a chair, as shown and described.

DESCRIPTION

FIG. 1 is a front perspective view of an embodiment of a chair showing my new design;
FIG. 2 is a front view thereof;
FIG. 3 is a rear view thereof;
FIG. 4 is a left side view thereof;
FIG. 5 is a right side view thereof; and,
FIG. 6 is a top view thereof.

The dashed lines shown in FIGS. 1-6 are included for the purpose of illustrating environmental subject matter only and form no part of the claimed design. In the embodiment shown in FIGS. 1-6, the material that covers the seat back and bottom is comprised of a wire mesh material. The bottom view is omitted and forms no part of the claimed design.

1 Claim, 6 Drawing Sheets

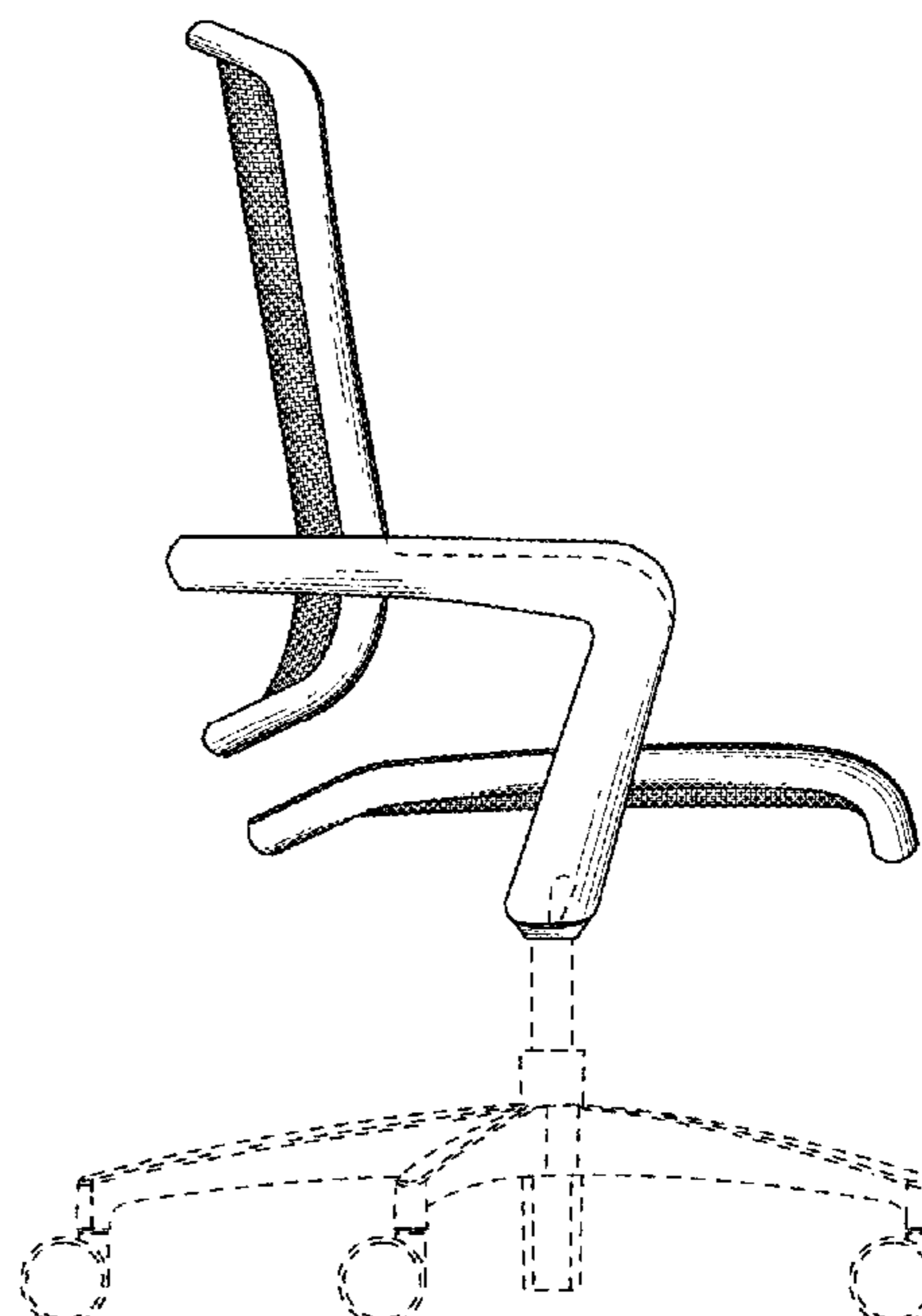
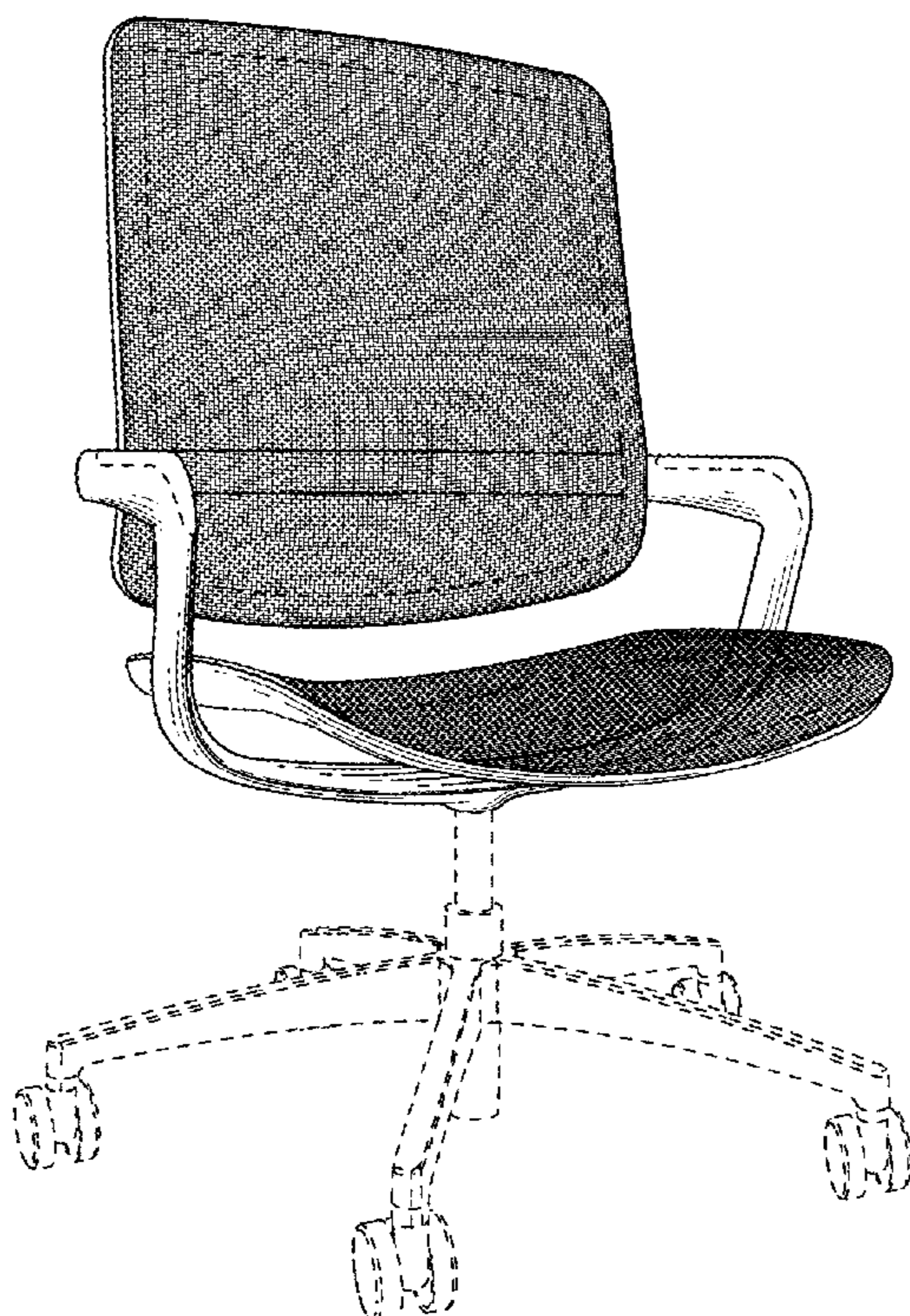

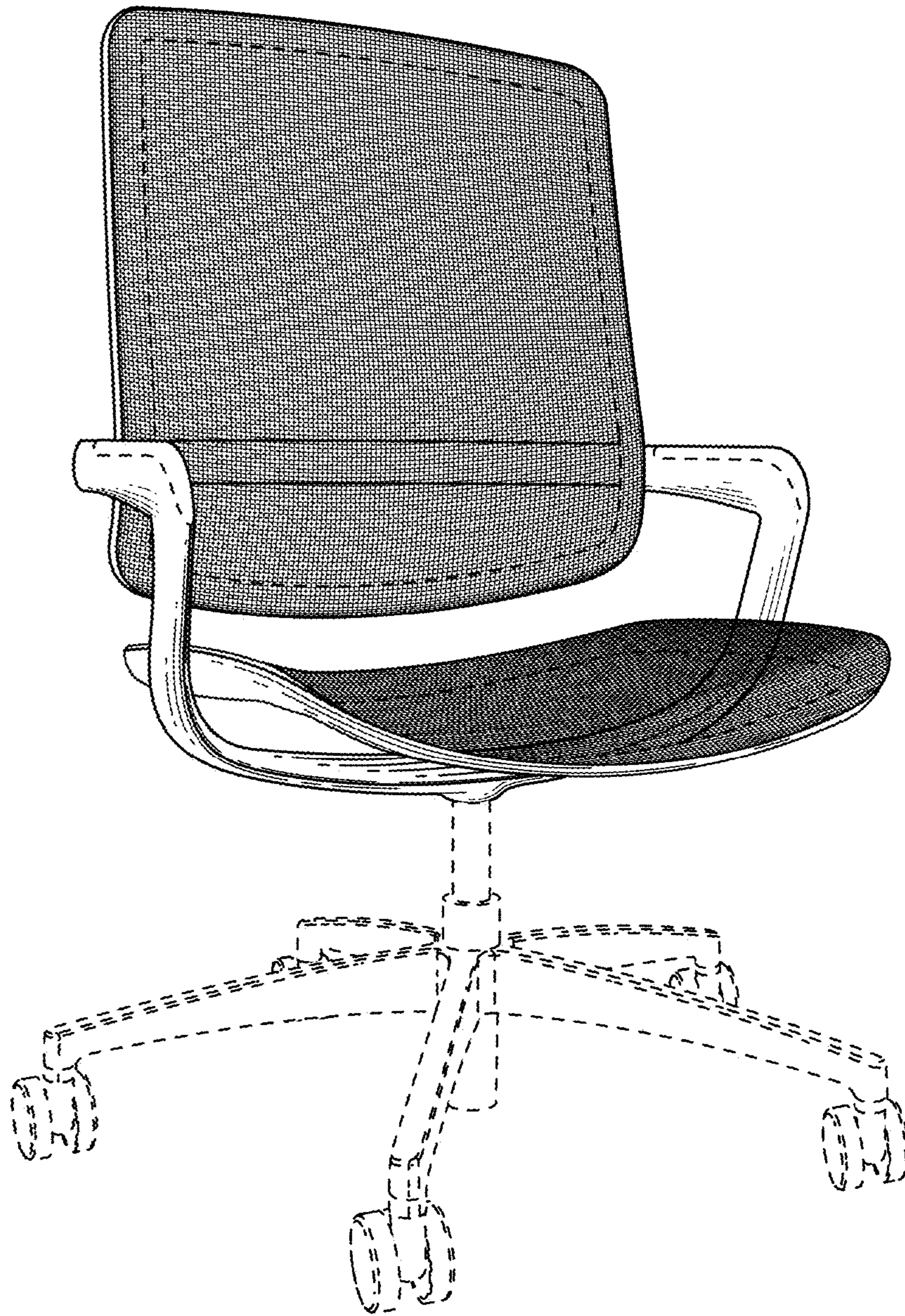

FIG. 1

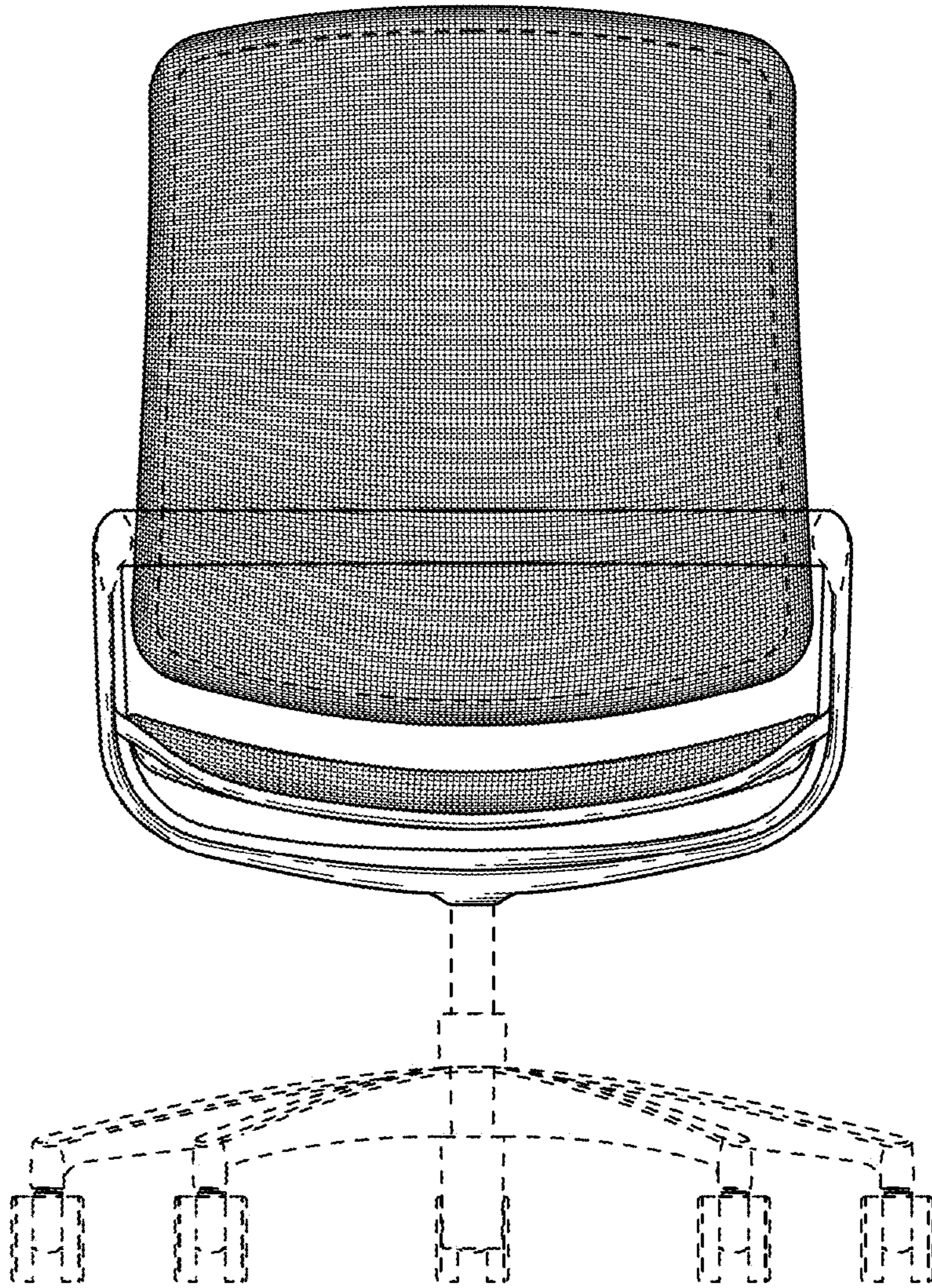

FIG. 2

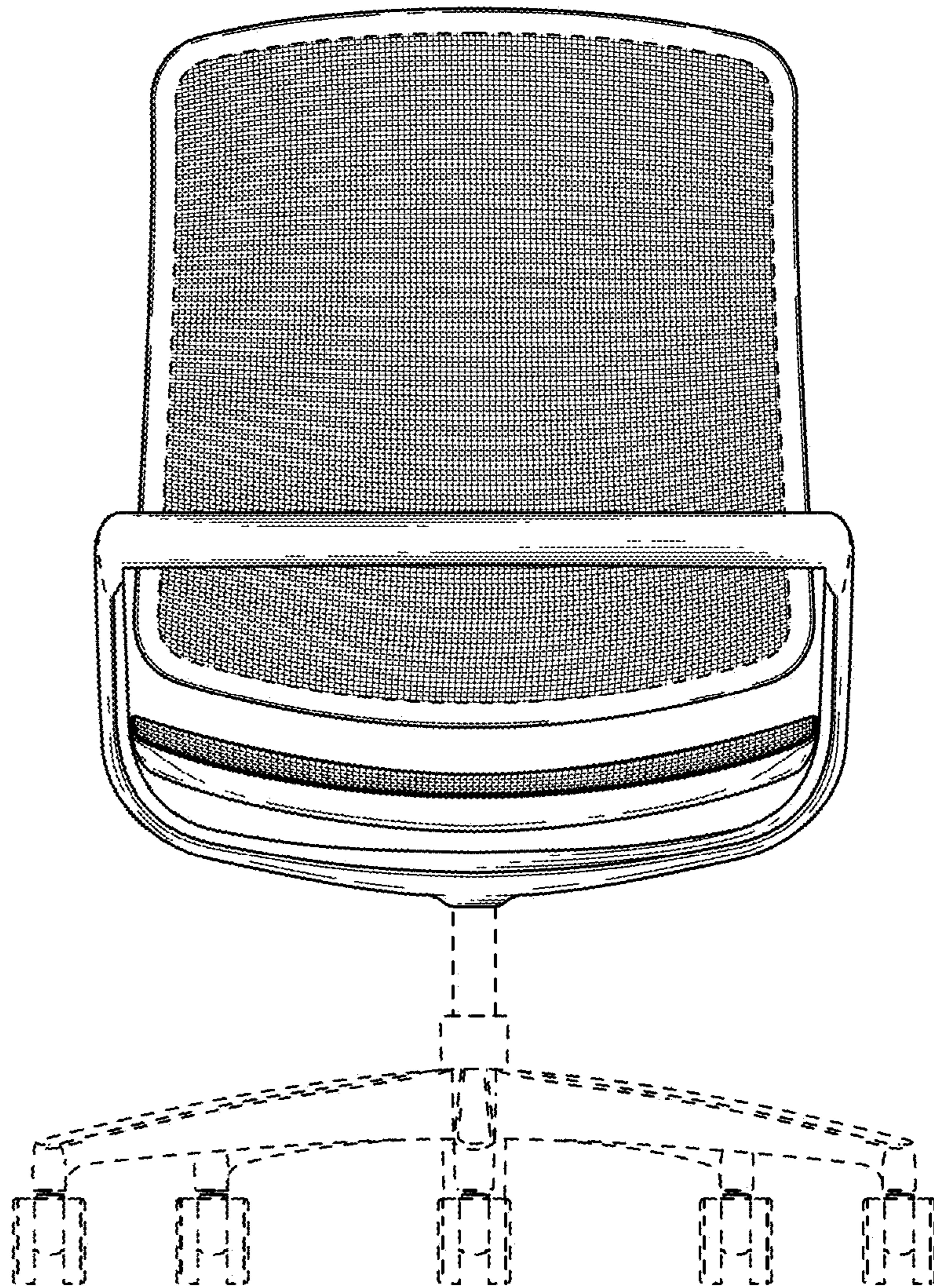

FIG. 3

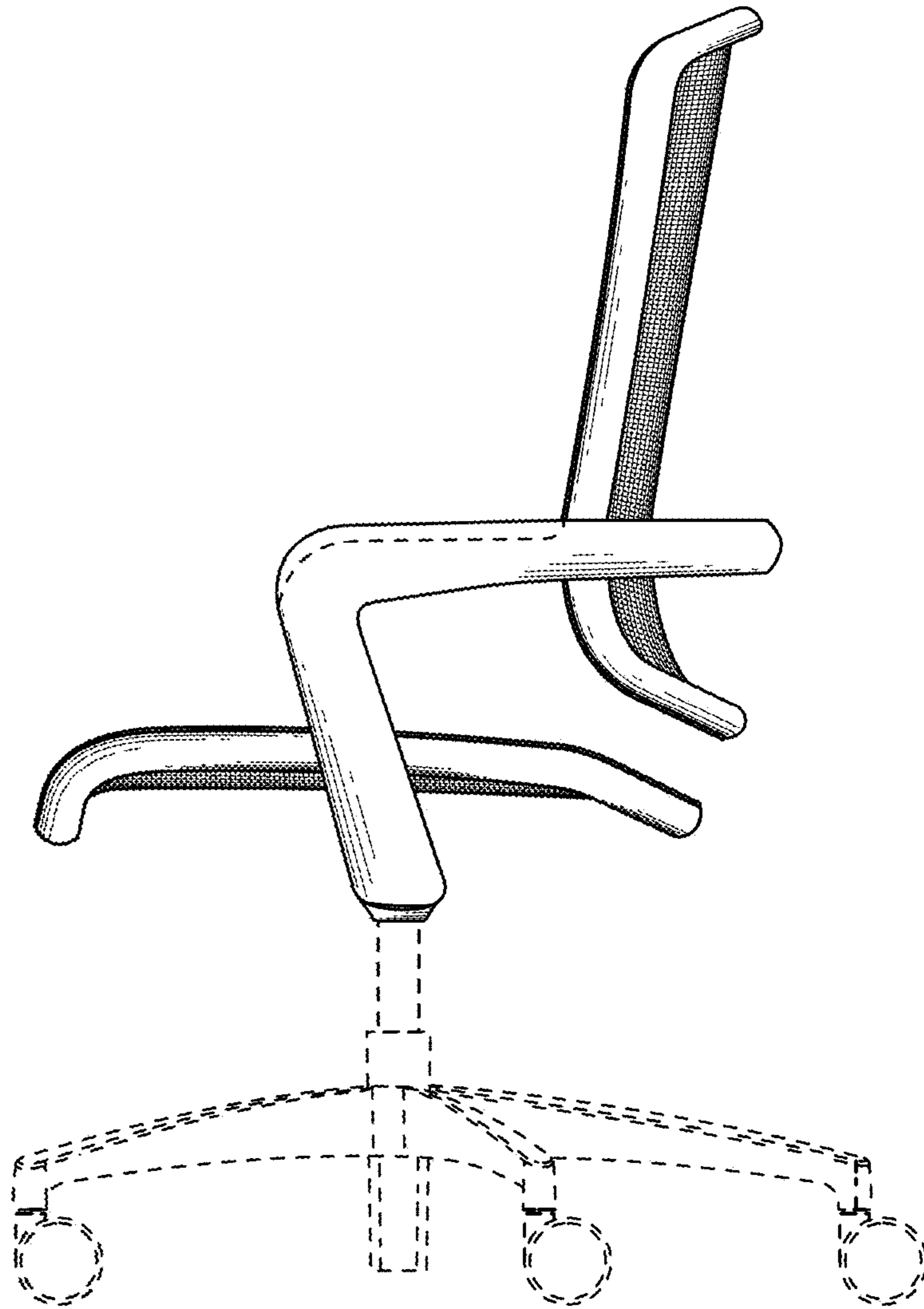

FIG. 4

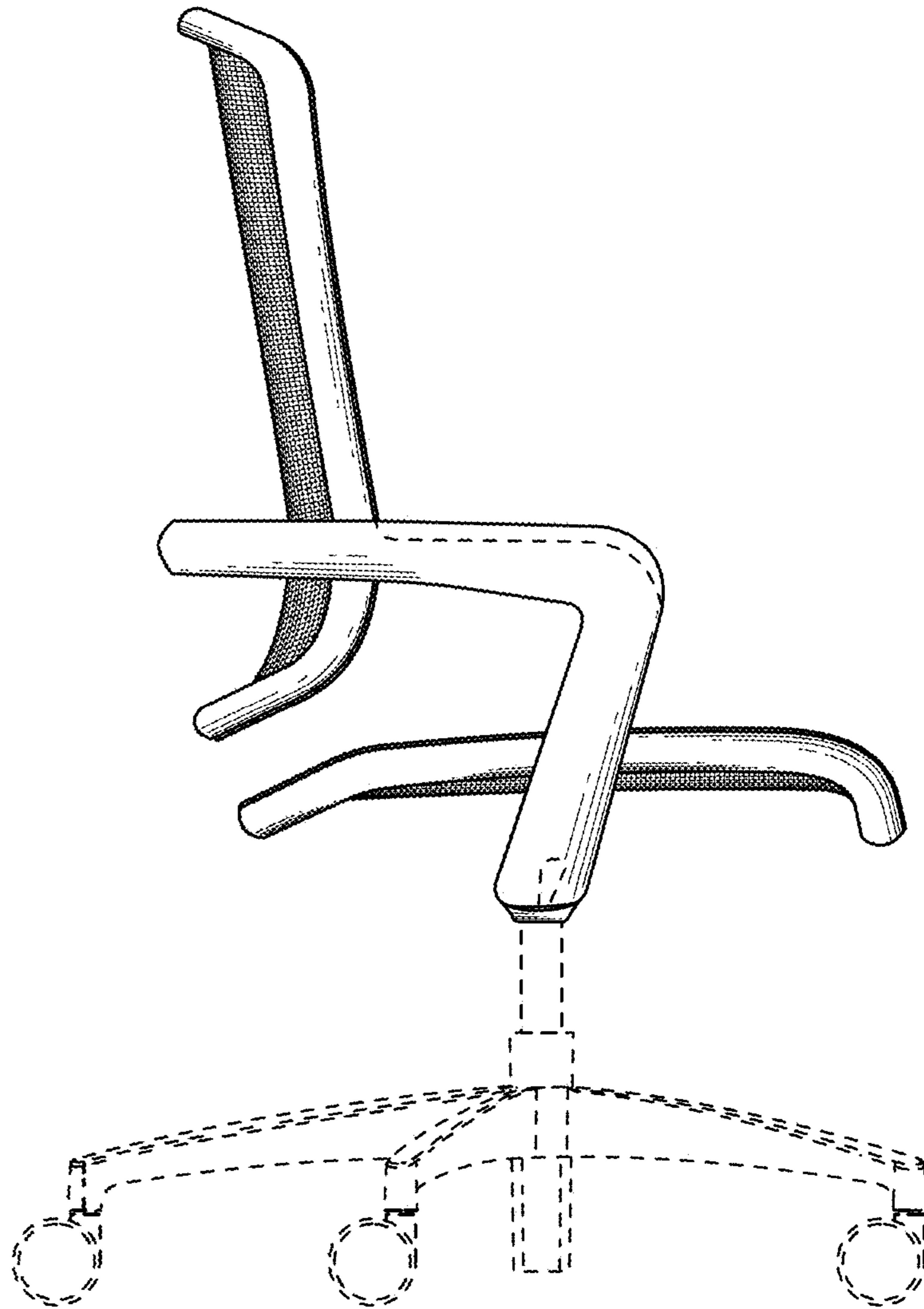

FIG. 5

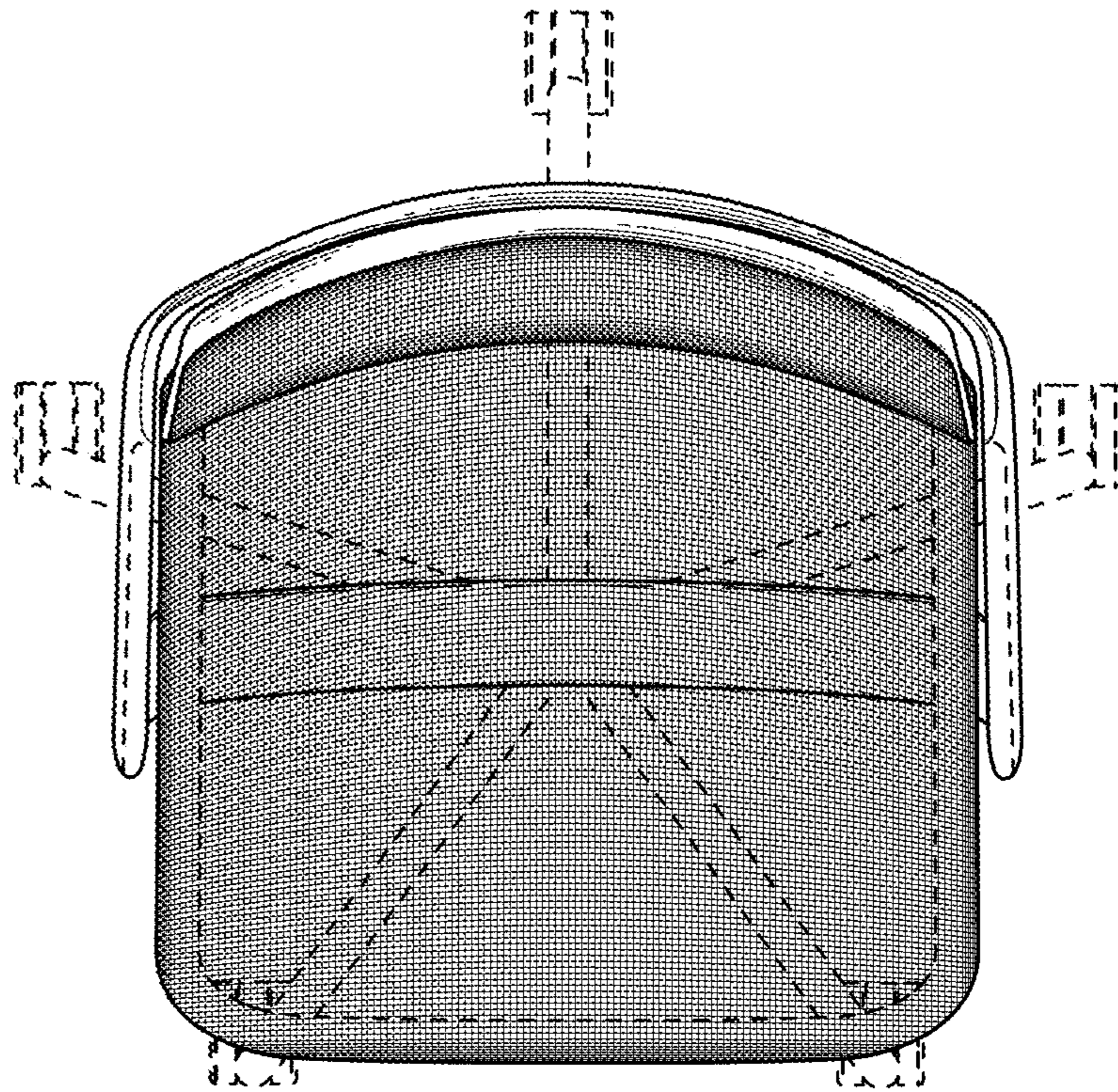

FIG. 6