



US00D702973S

(12) **United States Design Patent**
Norland et al.

(10) **Patent No.:** **US D702,973 S**
(45) **Date of Patent:** **** Apr. 22, 2014**

(54) **STAND MIXER COVER**

(71) Applicant: **Whirlpool Corporation**, Benton Harbor, MI (US)

(72) Inventors: **Leif A. Norland**, Saint Joseph, MI (US);
Kaitlyn M. Benoit, Saint Joseph, MI (US)

(73) Assignee: **Whirlpool Corporation**, Benton Harbor, MI (US)

(**) Term: **14 Years**

(21) Appl. No.: **29/447,361**

(22) Filed: **Mar. 1, 2013**

(51) **LOC (10) CL.** **06-13**

(52) **U.S. CL.**
USPC **D6/610**

(58) **Field of Classification Search**

USPC D6/610, 611, 596, 601, 602, 603, 615,
D6/617, 621; D7/332, 334-337;
D12/401-405; 135/87, 88.01, 95;
150/165-167, 158, 154; 280/770;
296/136.01, 136.1, 136.11

See application file for complete search history.

(56) **References Cited**

U.S. PATENT DOCUMENTS

D483,212	S	*	12/2003	Trickett	D6/610
7,152,733	B2	*	12/2006	Trickett	206/320
7,594,695	B2	*	9/2009	Noonan	297/184.11
D623,582	S	*	9/2010	Smith	D12/401
D642,848	S	*	8/2011	Van Note	D6/610
2001/0038023	A1	*	11/2001	Trevino	224/153

* cited by examiner

Primary Examiner — Katrina A Betton

(57) **CLAIM**

We claim the ornamental design for a stand mixer cover, as shown and described.

DESCRIPTION

FIG. 1 is a top perspective view of one embodiment of a stand mixer cover;

FIG. 2 is a first side elevational view of the stand mixer cover of FIG. 1;

FIG. 3 is a second side elevational view of the of FIG. 1;

FIG. 4 is a third side elevational view of the stand mixer cover of FIG. 1;

FIG. 5 is a fourth side elevational view of the stand mixer cover of FIG. 1;

FIG. 6 is a top plan view of the stand mixer cover of FIG. 1;

FIG. 7 is a bottom plan view of the stand mixer cover of FIG. 1;

FIG. 8 is a top perspective view of another embodiment of a stand mixer cover;

FIG. 9 is a first side elevational view of the stand mixer cover of FIG. 8;

FIG. 10 is a second side elevational view of the stand mixer cover of FIG. 8;

FIG. 11 is a third side elevational view of the stand mixer cover of FIG. 8;

FIG. 12 is a fourth side elevational view of the stand mixer cover of FIG. 8;

FIG. 13 is a top plan view of the stand mixer cover of FIG. 8; and,

FIG. 14 is a bottom plan view of the stand mixer cover of FIG. 8.

In the drawings, the broken lines in FIGS. 8, 10, 11, 12, 13 and 14 depict portions of the article that form no part of the claimed design.

1 Claim, 14 Drawing Sheets

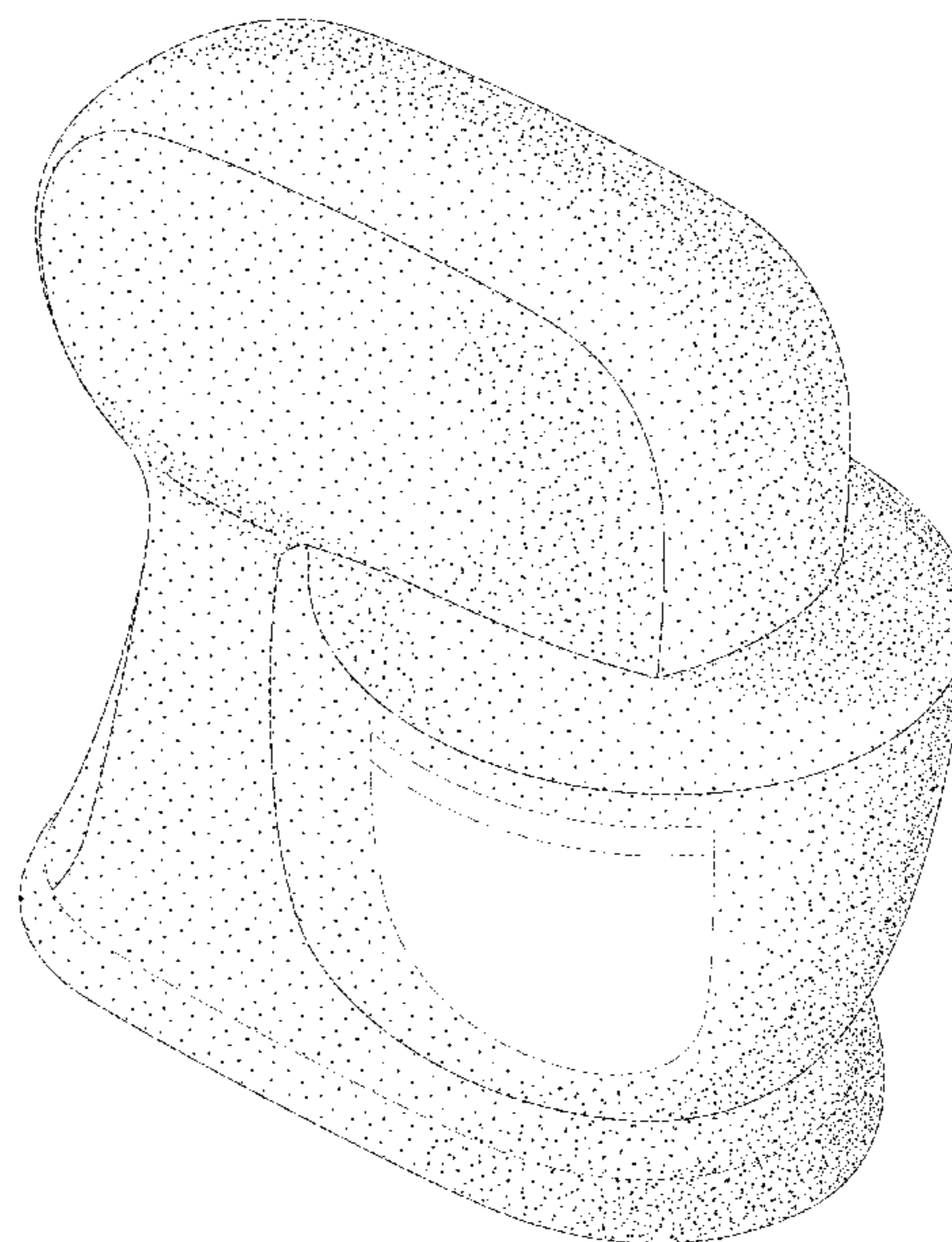
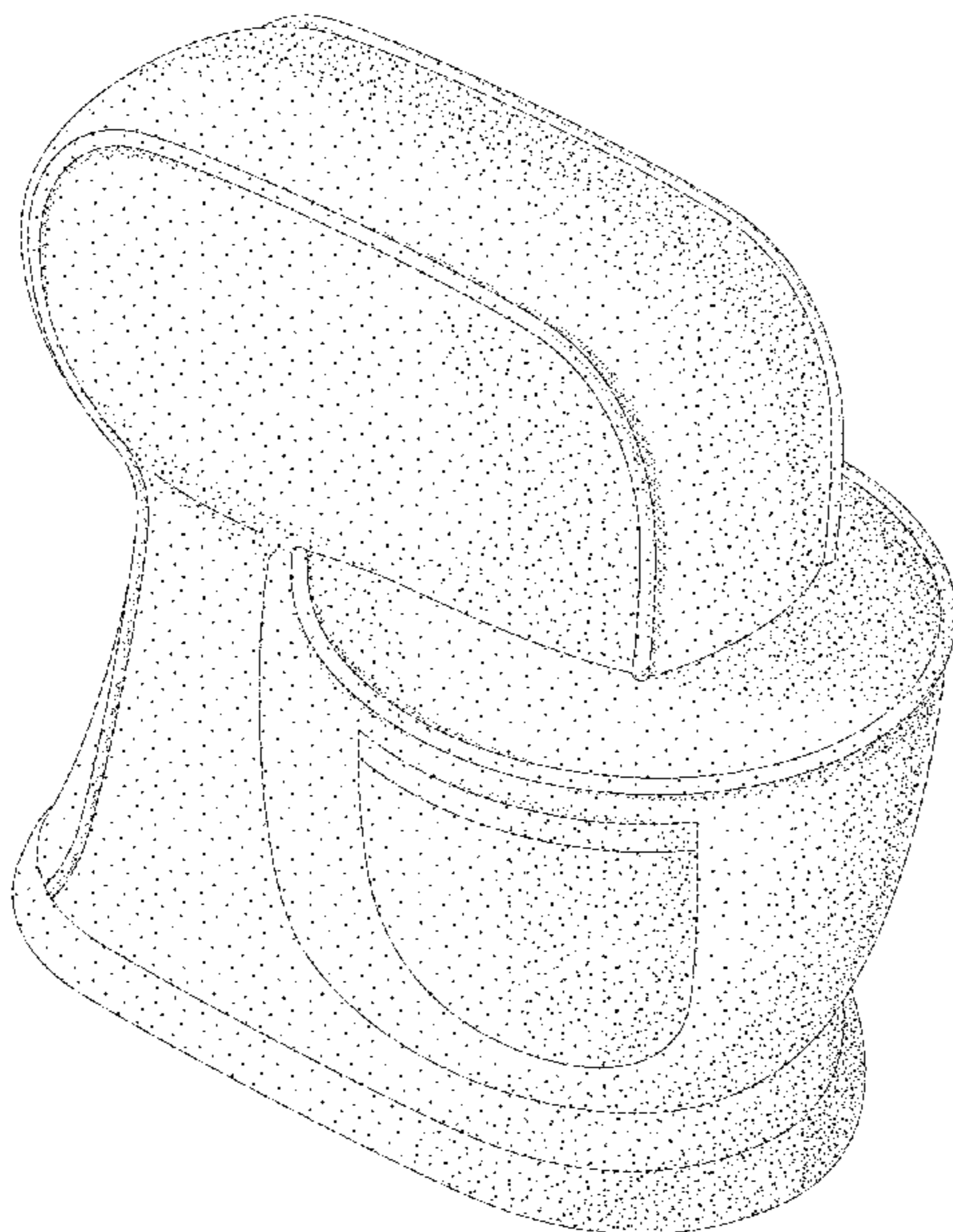

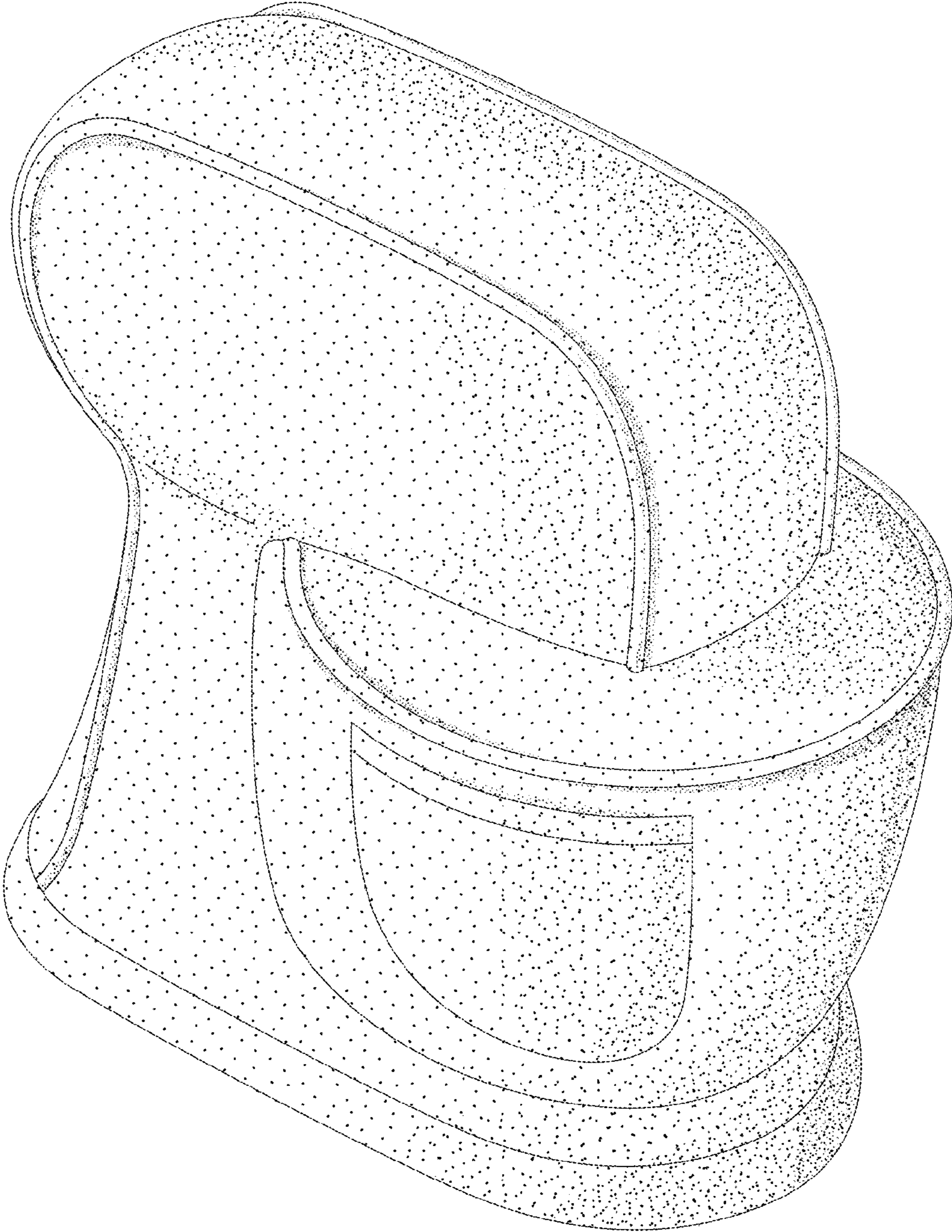

Fig. 1

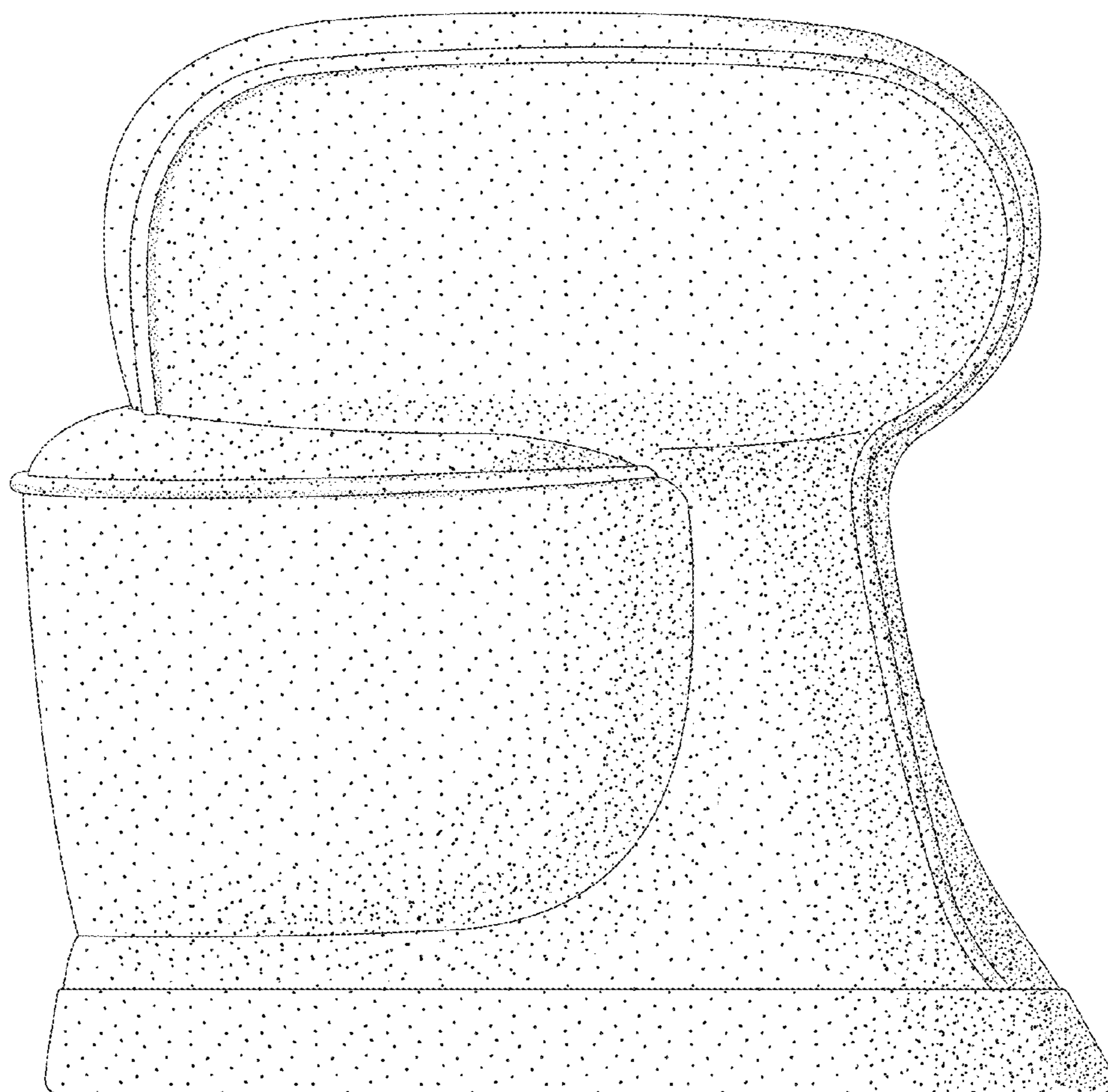

Fig. 2

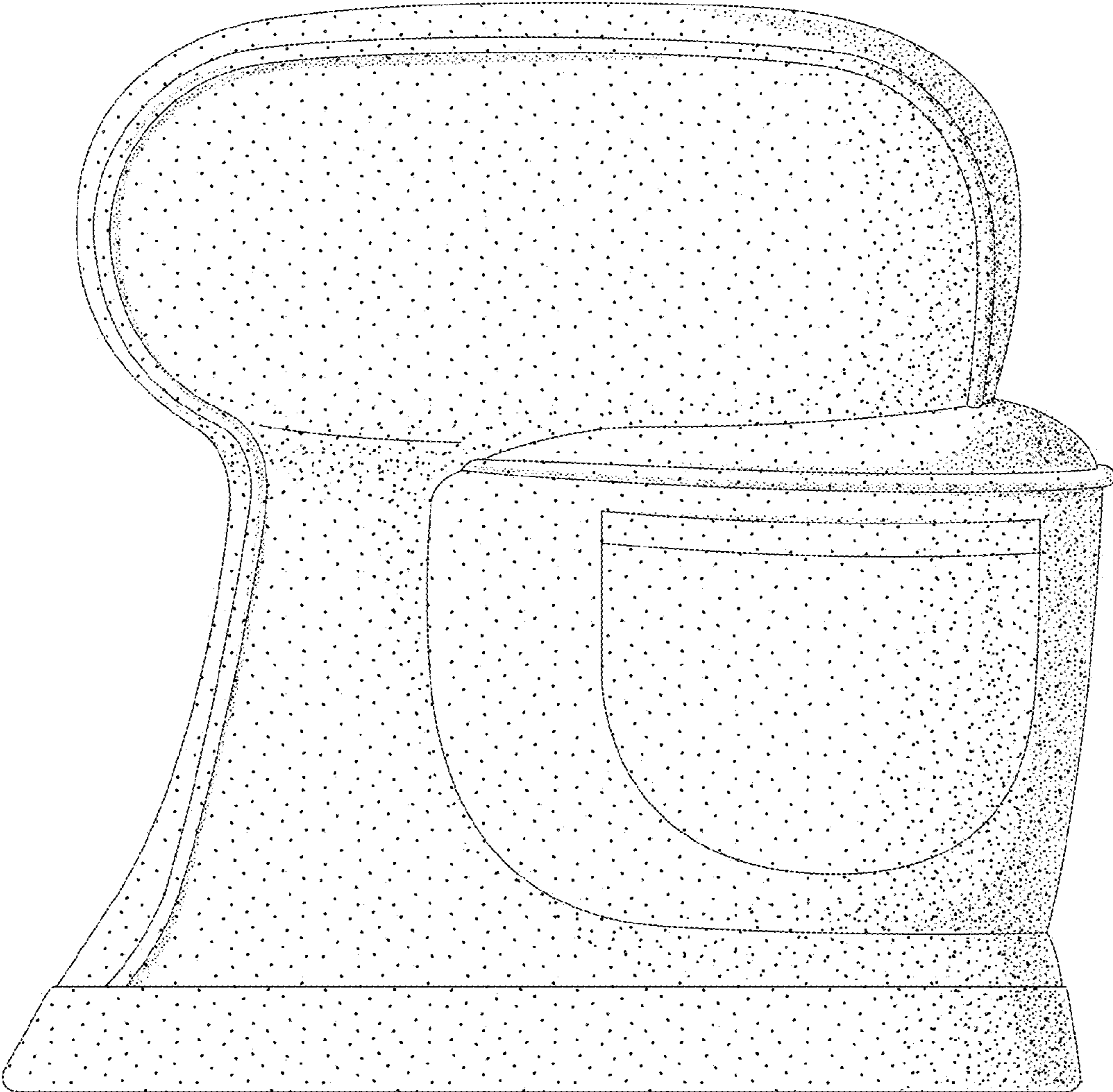

Fig. 3

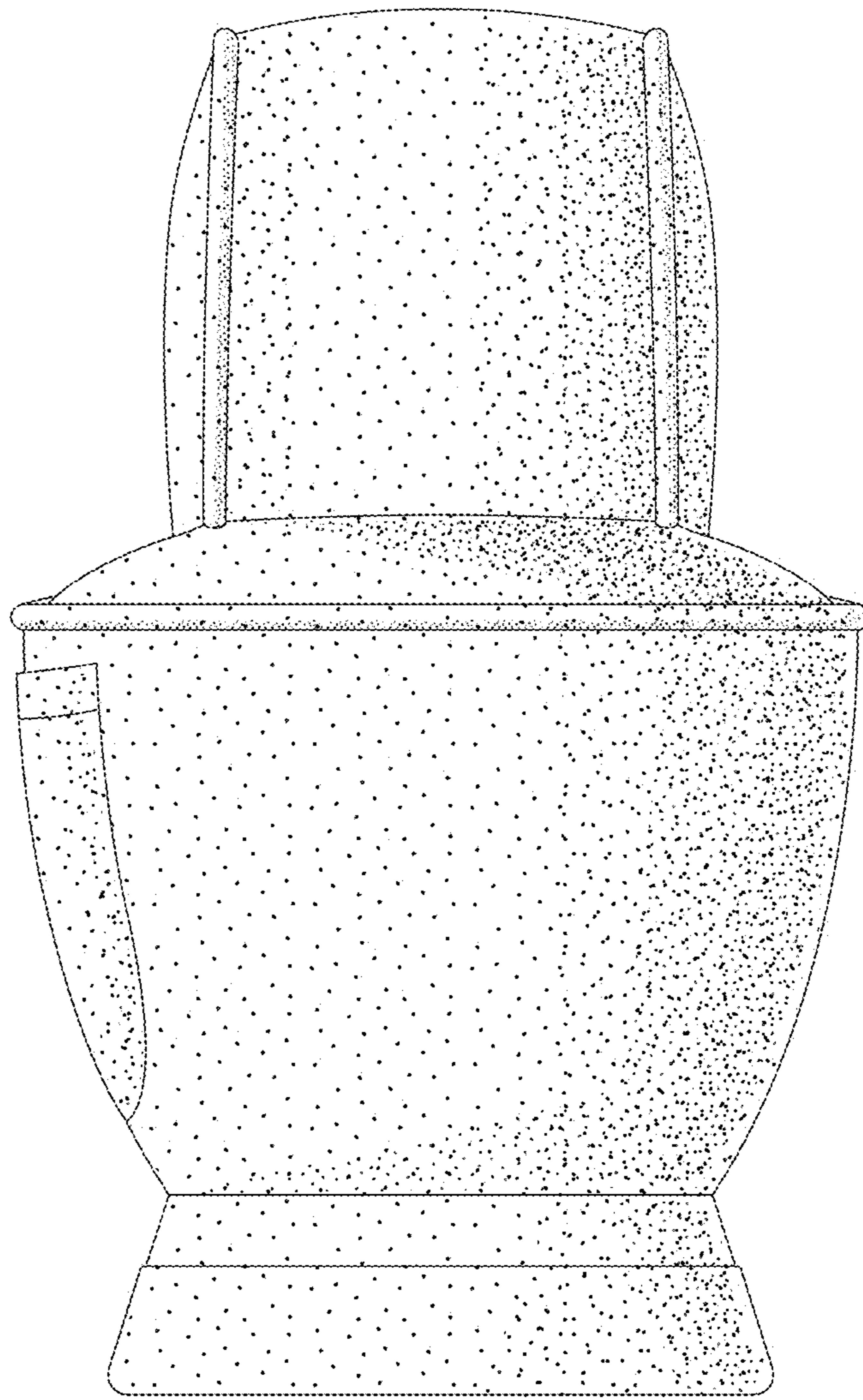

Fig. 4

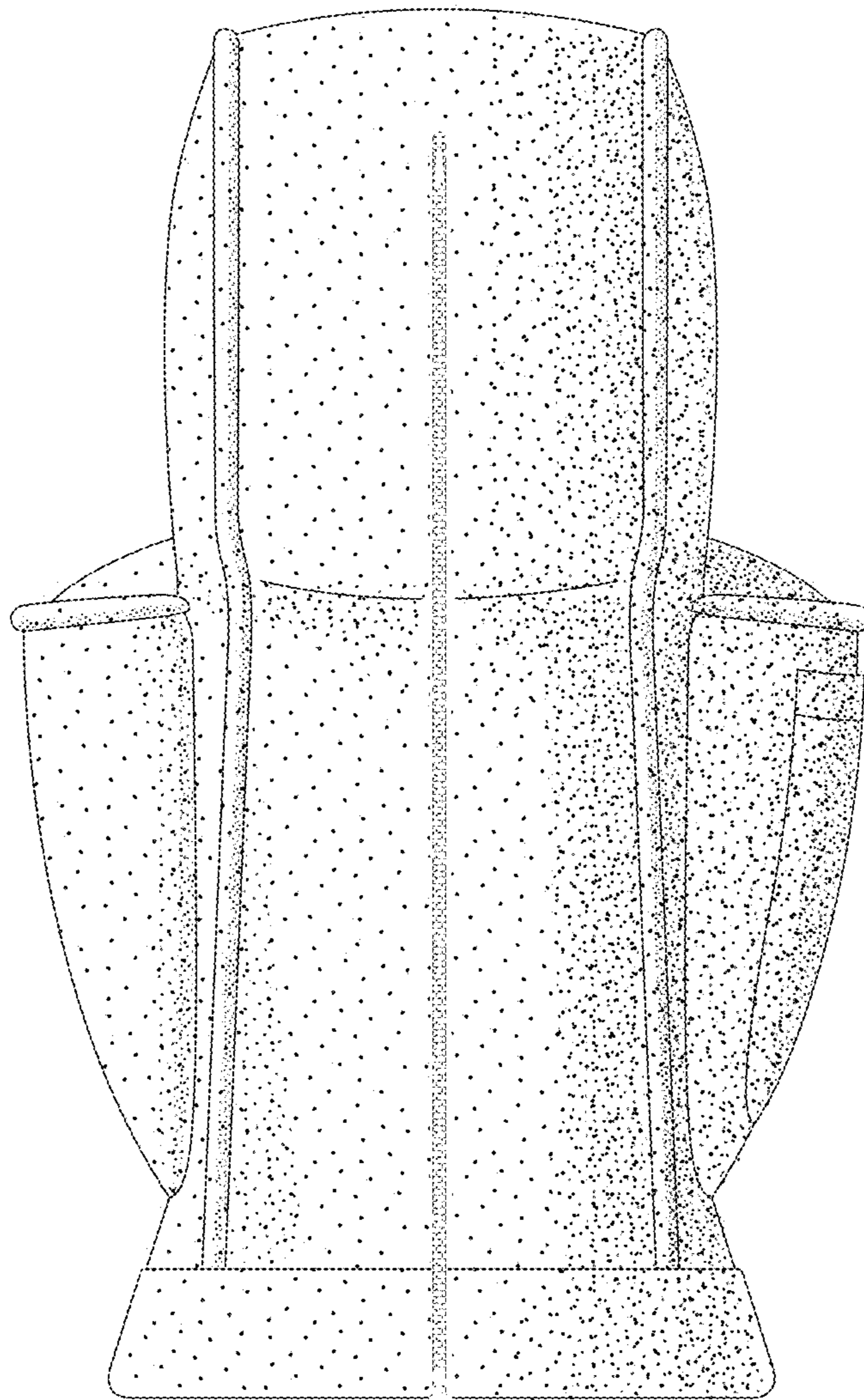

Fig. 5

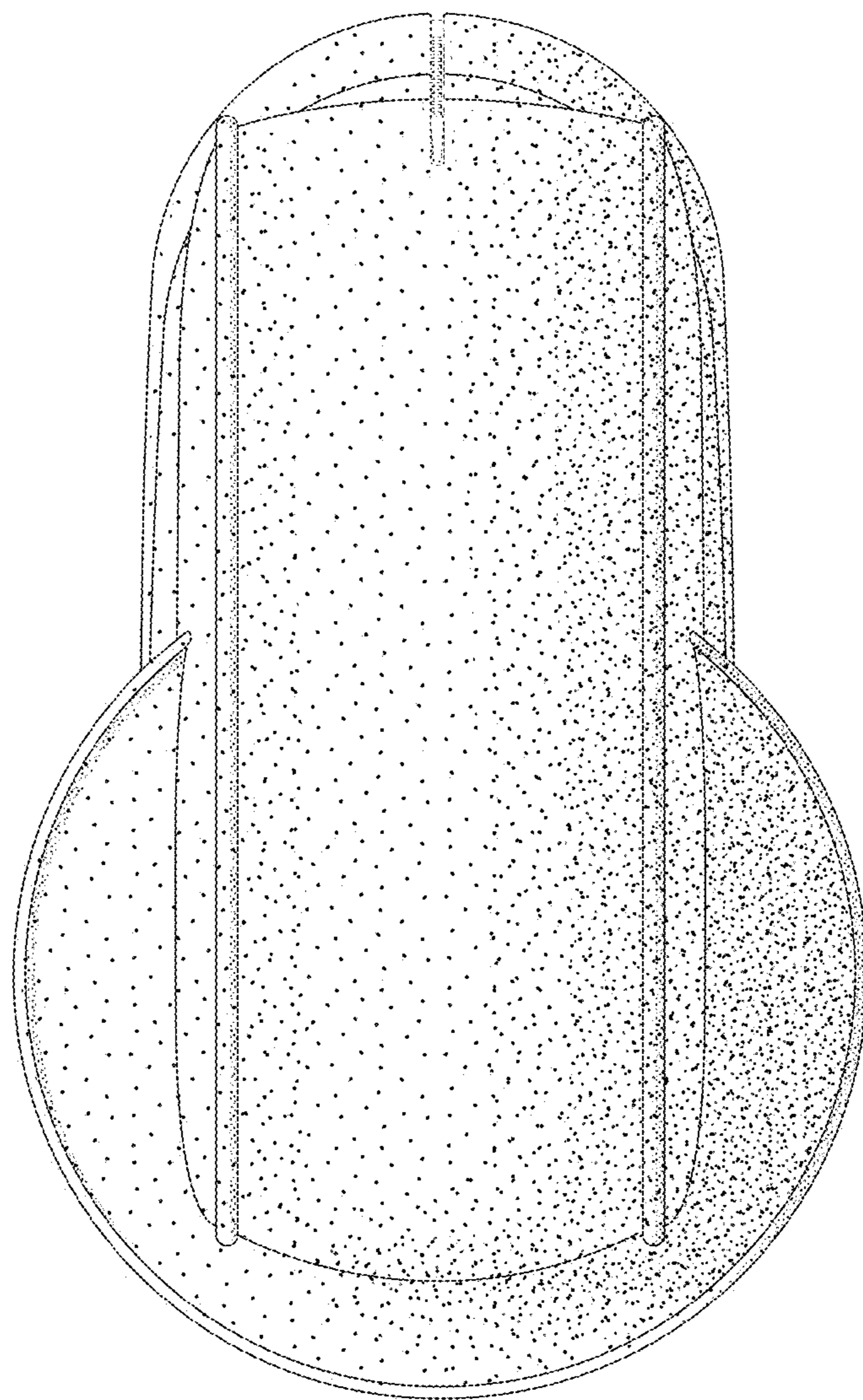

Fig. 6

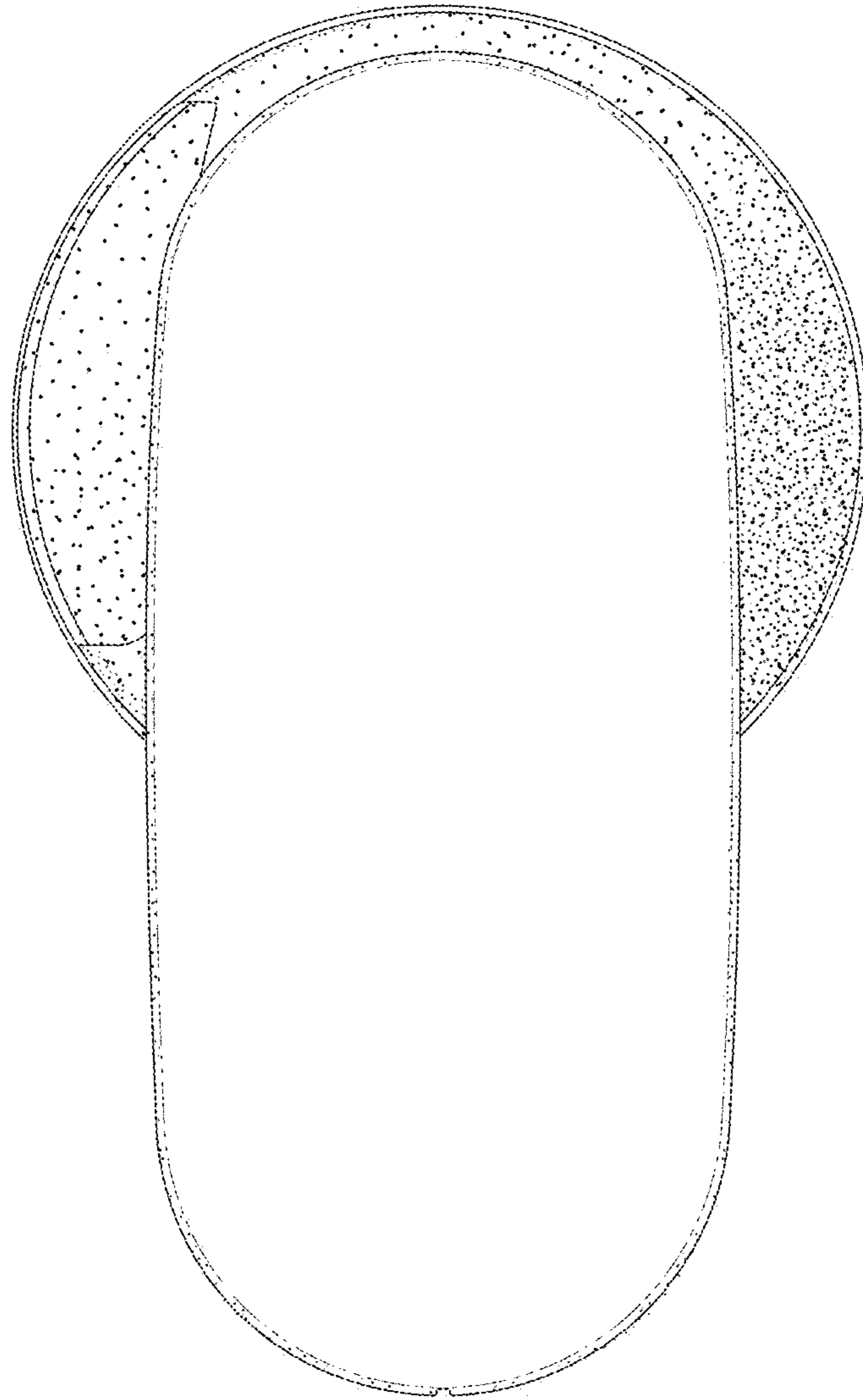

Fig. 7

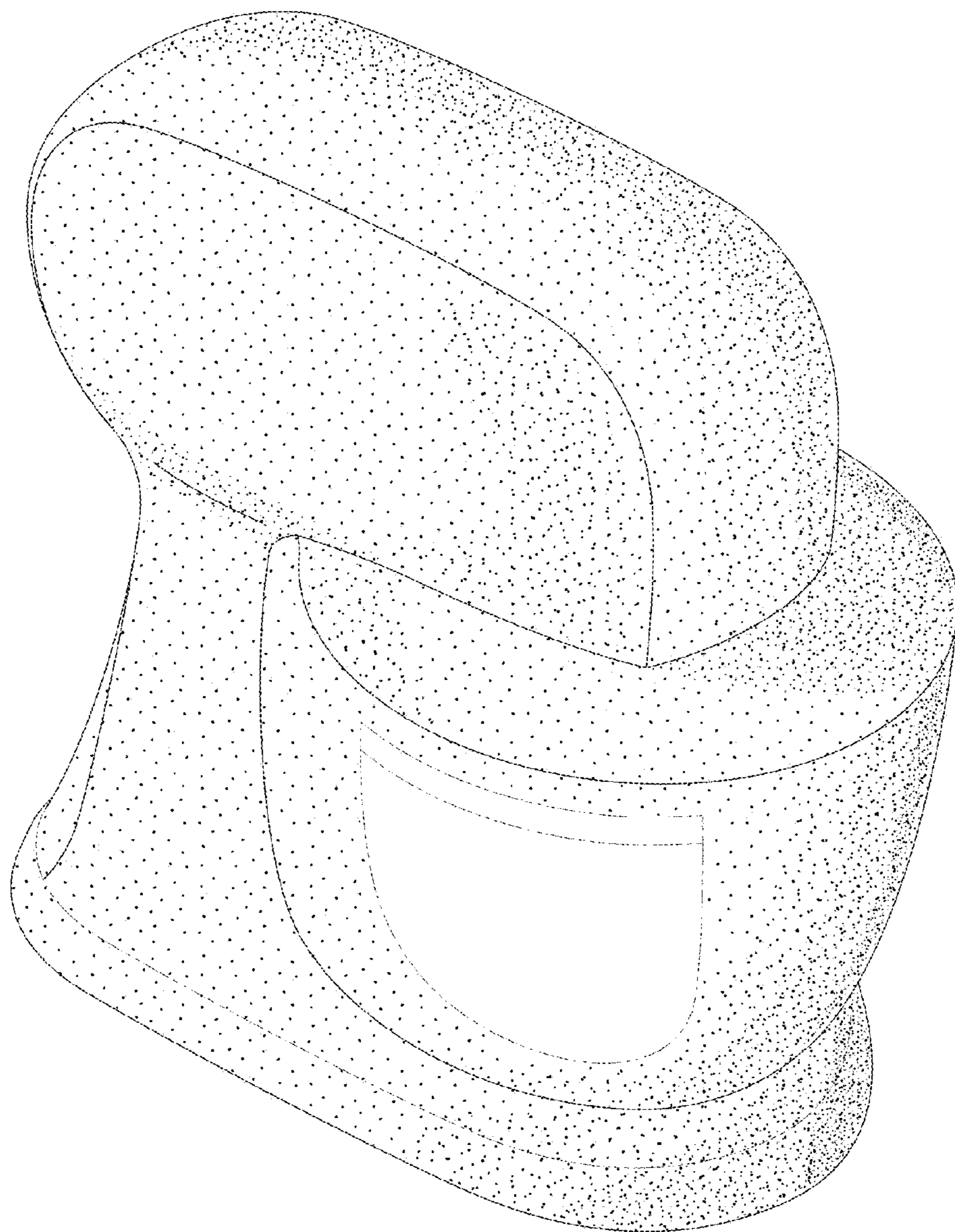

Fig. 8

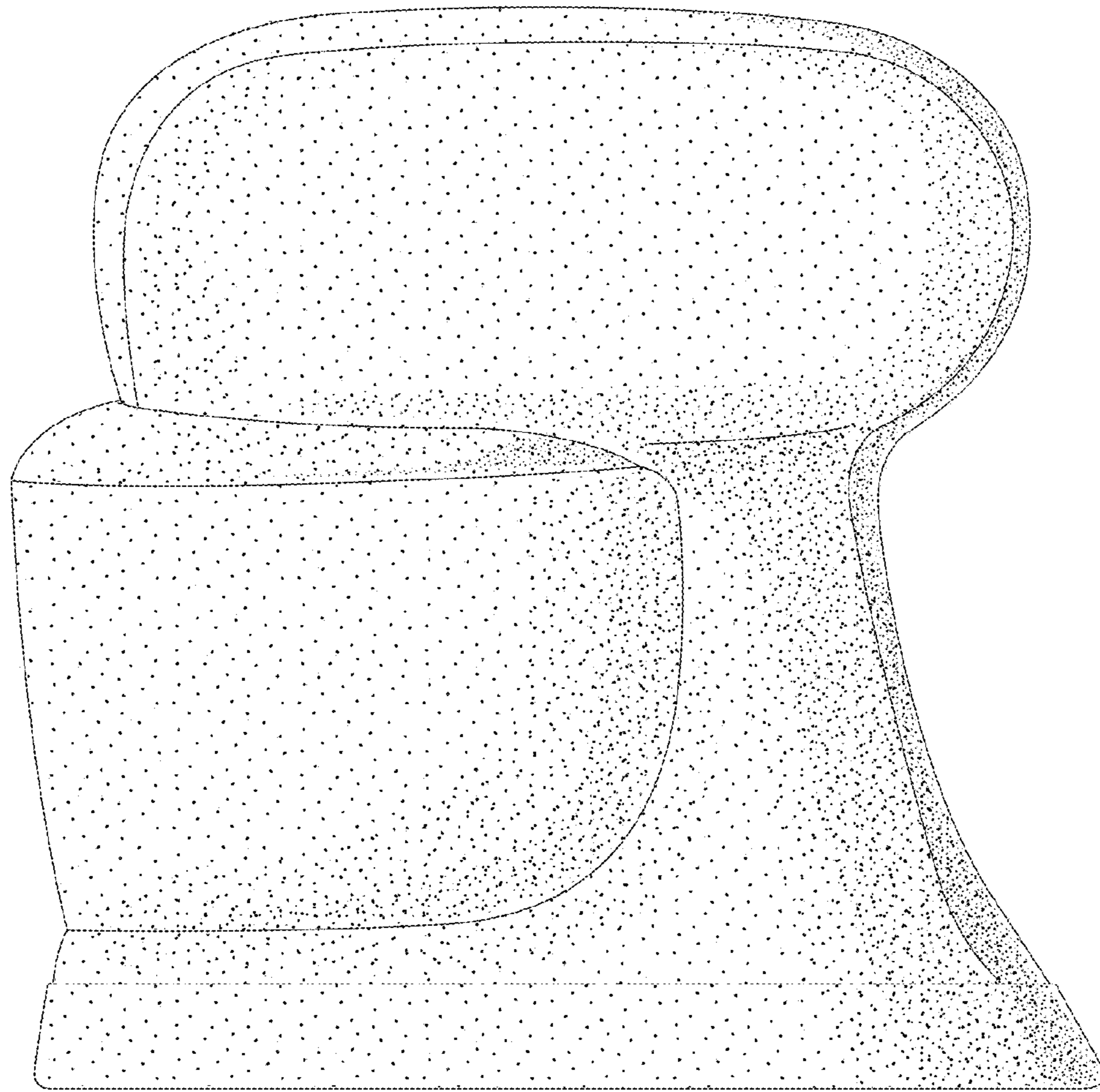

Fig. 9

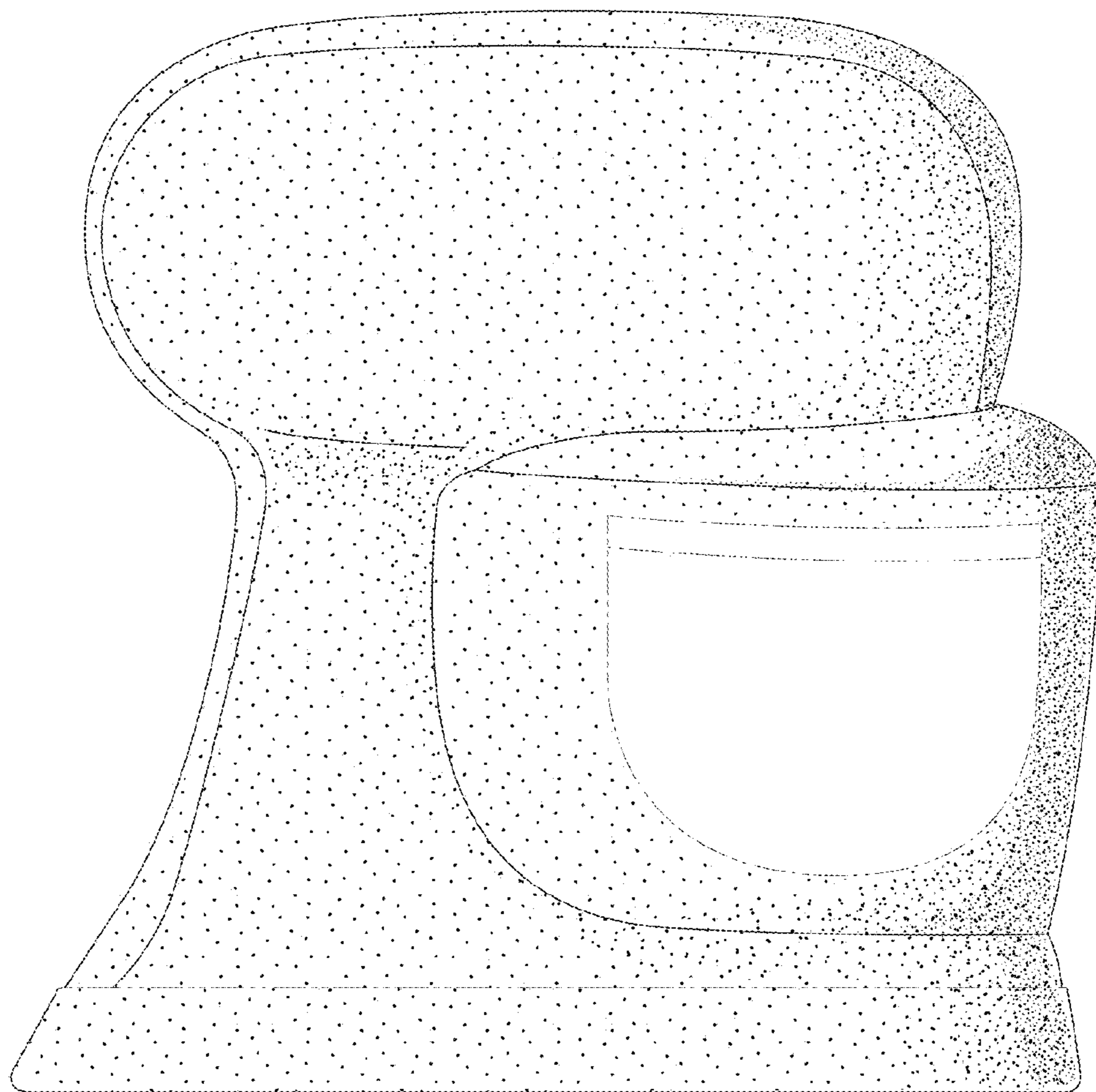

Fig. 10

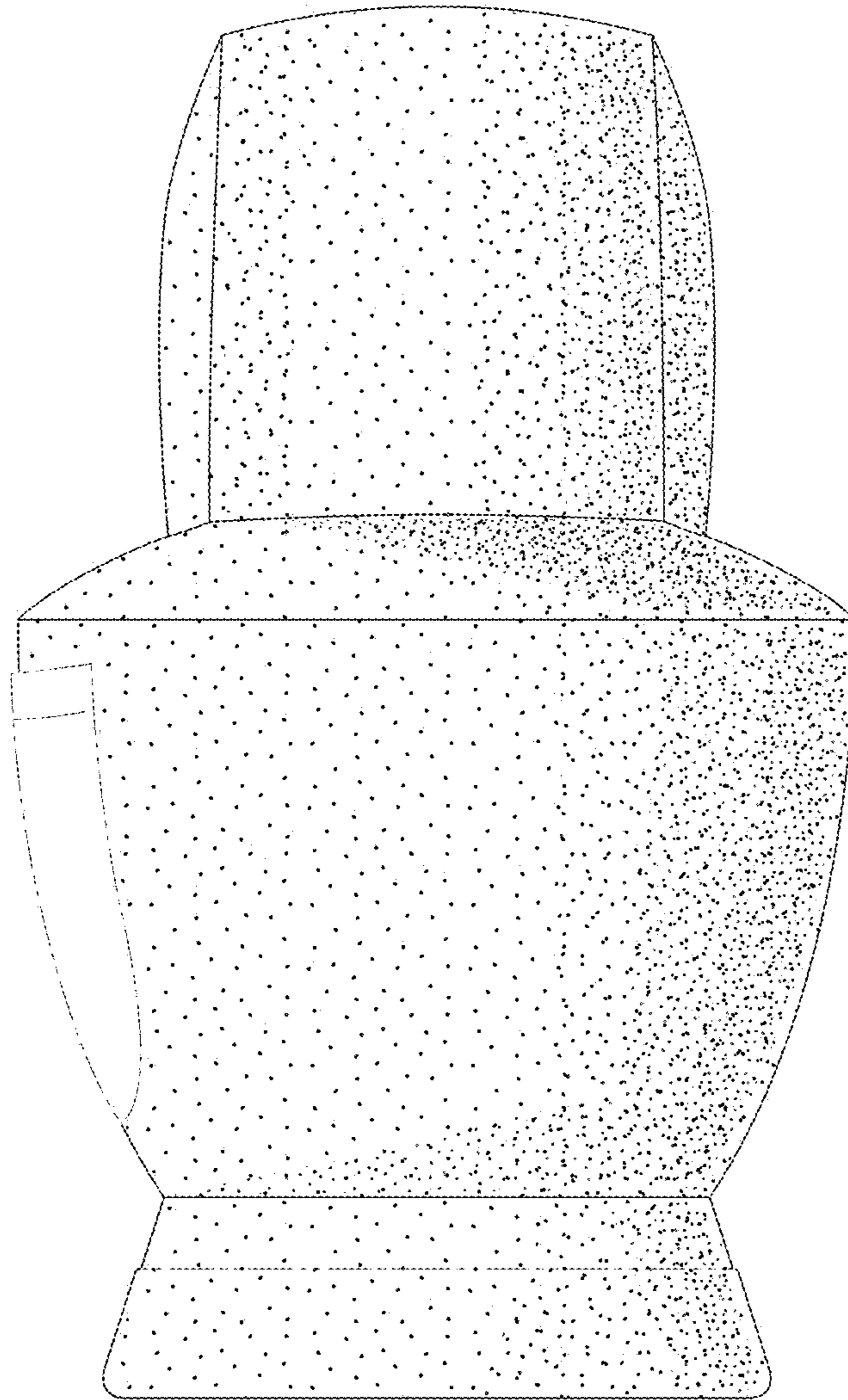

Fig. 11

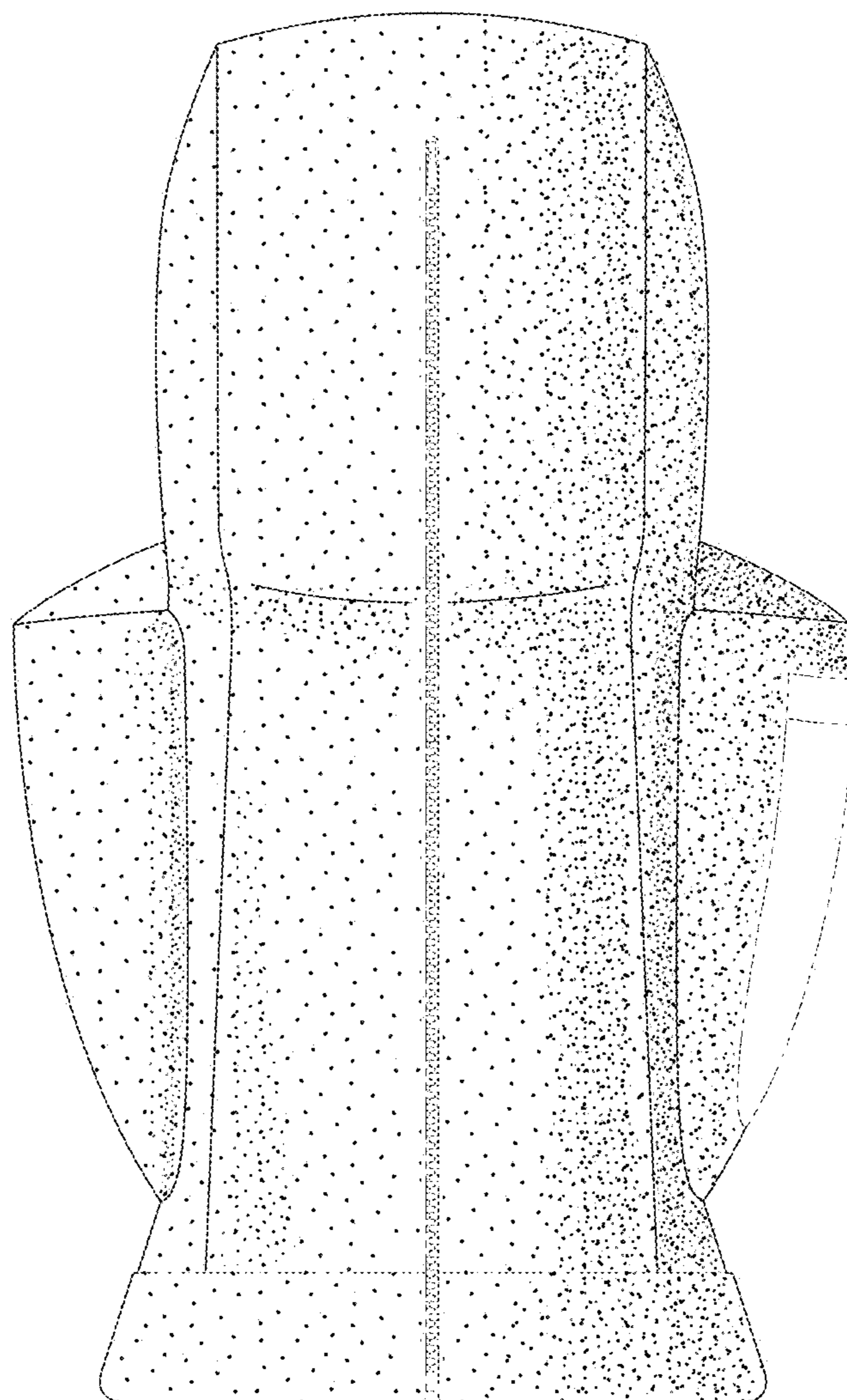

Fig. 12

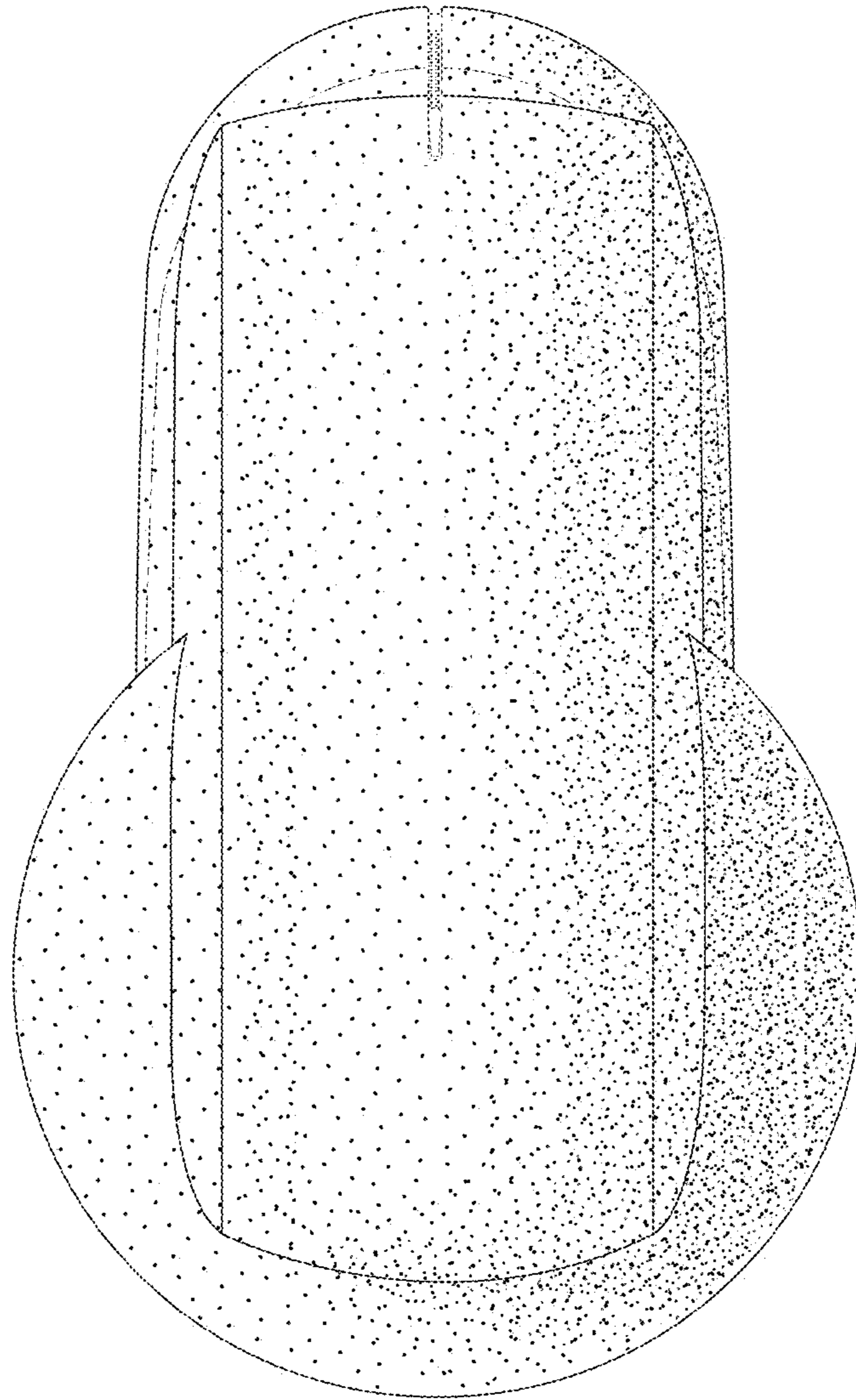

Fig. 13

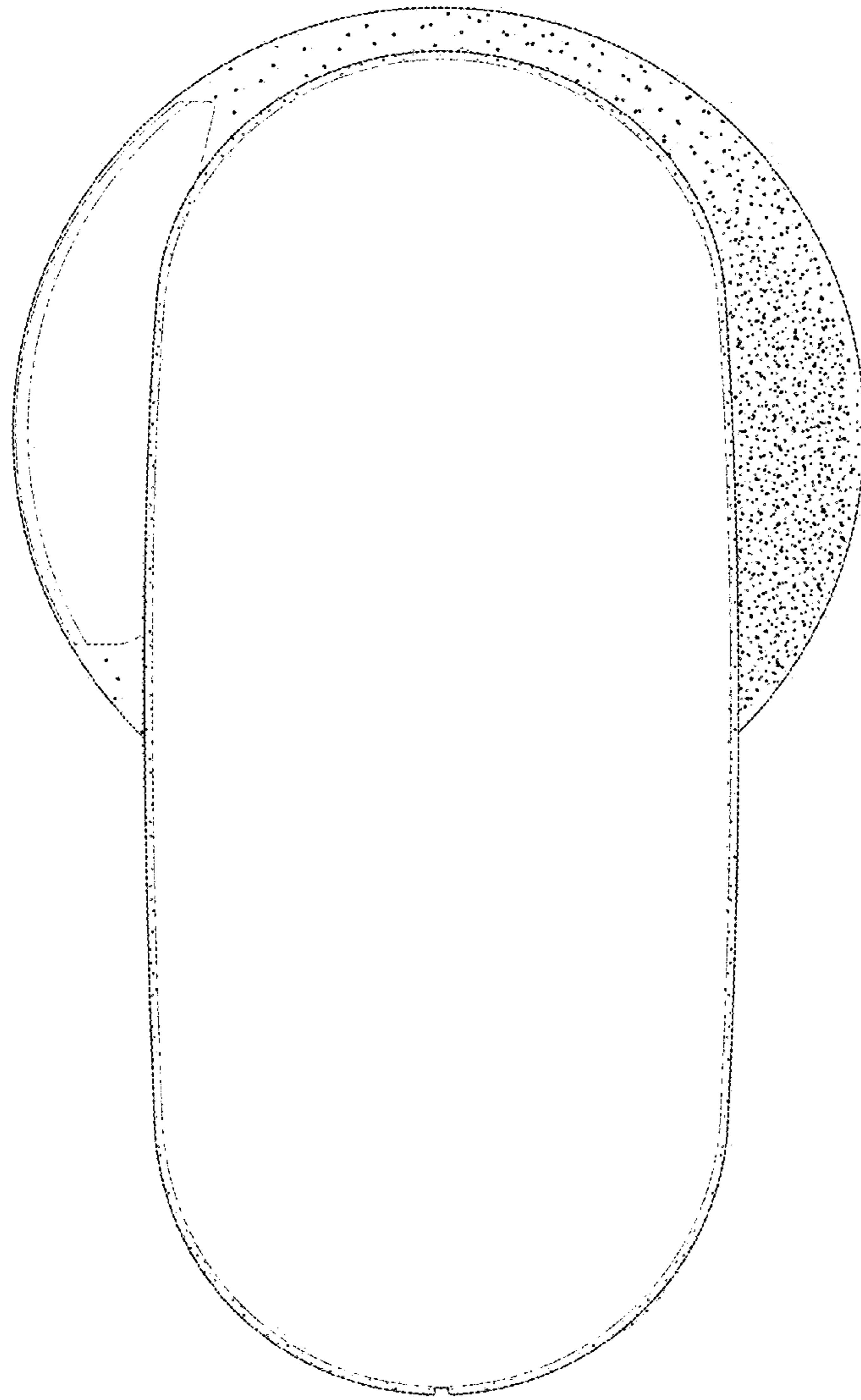

Fig. 14