



US00D702928S

(12) **United States Design Patent**
White

(10) **Patent No.:** **US D702,928 S**

(45) **Date of Patent:** **** Apr. 22, 2014**

(54) **HAT**

(71) Applicant: **Richard White**, Fremont, CA (US)

(72) Inventor: **Richard White**, Fremont, CA (US)

(**) Term: **14 Years**

(21) Appl. No.: **29/443,889**

(22) Filed: **Jan. 23, 2013**

(51) **LOC (10) Cl.** **02-03**

(52) **U.S. Cl.**
USPC **D2/882**

(58) **Field of Classification Search**

USPC D2/865, 866, 872, 878, 879, 882, 883,
D2/884, 886, 887, 888, 891, 892; 2/171,
2/171.5, 171.6, 171.7, 171.8, 175.1,
2/175.9, 183, 195.1, 195.2, 209.12,
2/209.13, 209.3, 209.4, 209.5, 209.7

See application file for complete search history.

(56) **References Cited**

U.S. PATENT DOCUMENTS

1,190,427	A *	7/1916	Kromer, Jr.	2/181
2,094,104	A *	9/1937	Lee et al.	2/175.9
2,116,736	A *	5/1938	Subira	2/182.1
2,226,133	A *	12/1940	Lee, Jr.	2/175.3
2,284,854	A *	6/1942	Wall	2/175.9
D136,498	S	10/1943	Cookman	
D136,649	S	11/1943	Dannenberg	
2,505,403	A *	4/1950	Jacobi	2/175.4
2,779,947	A *	2/1957	Severy	2/181.4
D223,742	S *	6/1972	Johnson	D2/887
D277,521	S *	2/1985	Nasby	D2/892
D346,477	S *	5/1994	Harmon	D2/882
D403,840	S *	1/1999	Griffin	D2/882
D406,440	S *	3/1999	Wulle	D2/879
D406,687	S *	3/1999	Thorpe	D2/881
D417,770	S	12/1999	Greenwood	
D423,196	S *	4/2000	White	D2/882
D427,751	S *	7/2000	Richlin	D2/866

(Continued)

Primary Examiner — Karen E Eldridge Powers

(74) *Attorney, Agent, or Firm* — QuickPatents; Kevin Prince

(57) **CLAIM**

I claim the ornamental design for a hat, as shown and described.

DESCRIPTION

FIG. 1 is a top perspective view of a hat, showing a first embodiment of my new design;

FIG. 2 is a bottom perspective view of the hat as shown in FIG. 1;

FIG. 3 is a front elevational view of the hat as shown in FIG. 1;

FIG. 4 is a rear elevational view of the hat as shown in FIG. 1;

FIG. 5 is a left-side elevational view of the hat as shown in FIG. 1, the right-side elevational view being a mirror image thereof;

FIG. 6 is a top plan view of the hat as shown in FIG. 1;

FIG. 7 is a bottom plan view of the hat as shown in FIG. 1;

FIG. 8 is a top perspective view of a second embodiment of the hat thereof;

FIG. 9 is a bottom perspective view of the hat as shown in FIG. 8;

FIG. 10 is a front elevational view of the hat as shown in FIG. 8;

FIG. 11 is a rear elevational view of the hat as shown in FIG. 8;

FIG. 12 is a left-side elevational view of the hat as shown in FIG. 8, the right-side elevational view being a mirror image thereof;

FIG. 13 is a top plan view of the hat as shown in FIG. 8; and,

FIG. 14 is a bottom plan view of the hat as shown in FIG. 8.

The broken lines in the figures represent stitching, and are part of the claimed design.

1 Claim, 6 Drawing Sheets

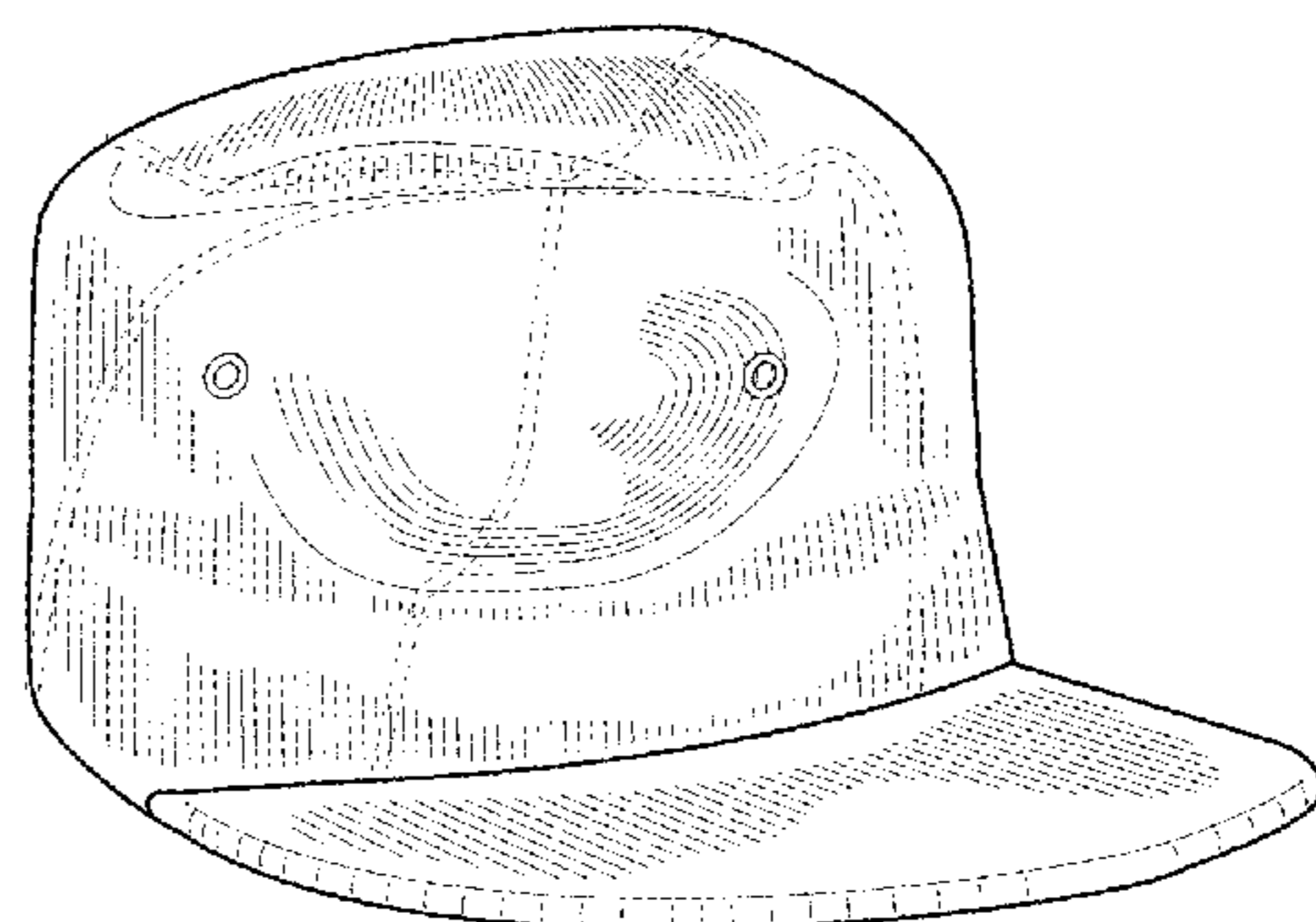
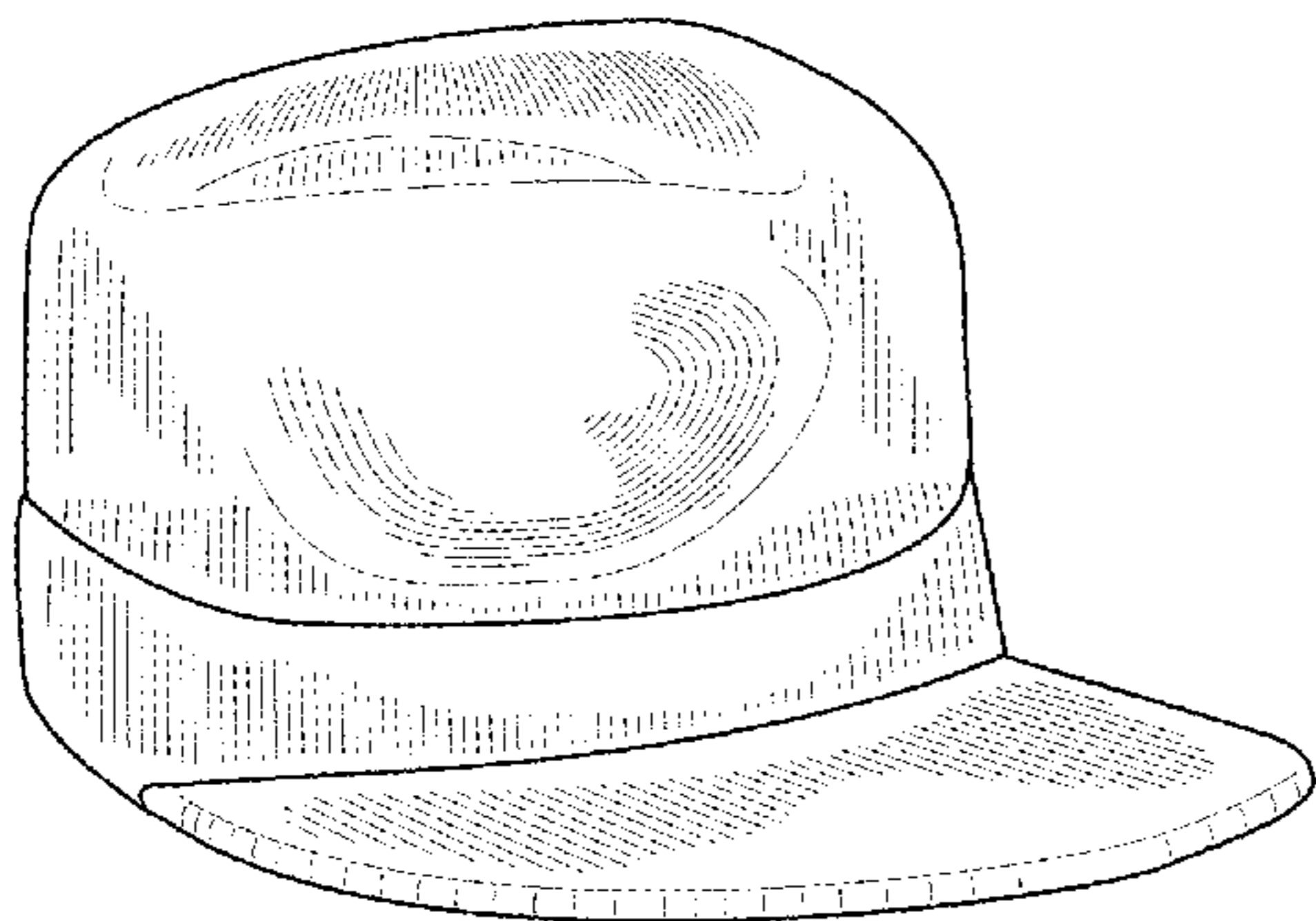

(56)

References Cited

U.S. PATENT DOCUMENTS

D496,145 S *	9/2004	Lacey	D2/866	D616,633 S	6/2010	Lacy	
7,024,702 B2 *	4/2006	Kronenberger	2/209.3	D617,537 S *	6/2010	Pearson	D2/884
D528,744 S *	9/2006	Nelson	D2/882	D636,976 S	5/2011	McIntosh	
D541,508 S *	5/2007	Day	D2/866	D661,060 S	6/2012	Eveleth	
D557,480 S	12/2007	Horton		D661,062 S	6/2012	Eveleth	
D566,380 S	4/2008	Galvan		D661,063 S *	6/2012	Eveleth	D2/882
D570,580 S *	6/2008	Paul et al.	D2/882	D661,064 S	6/2012	Eveleth	
D571,539 S *	6/2008	Valcourt	D2/866	D670,892 S *	11/2012	Epstein	D2/882
				D691,349 S *	10/2013	Pearson	D2/882
				2002/0095715 A1 *	7/2002	Hong	2/209.11
				2006/0117460 A1 *	6/2006	Yan	2/209.3

* cited by examiner

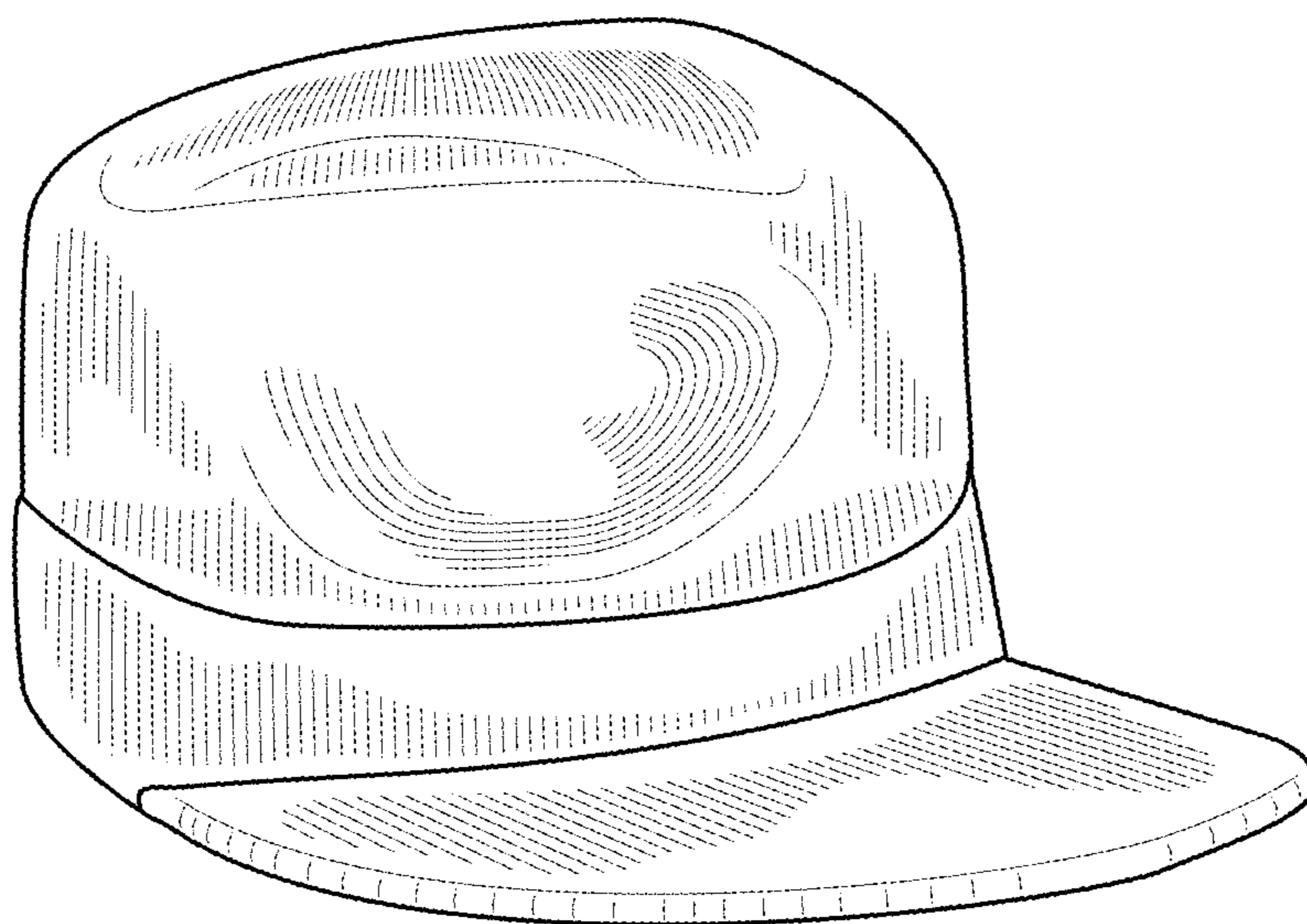

FIG. 1

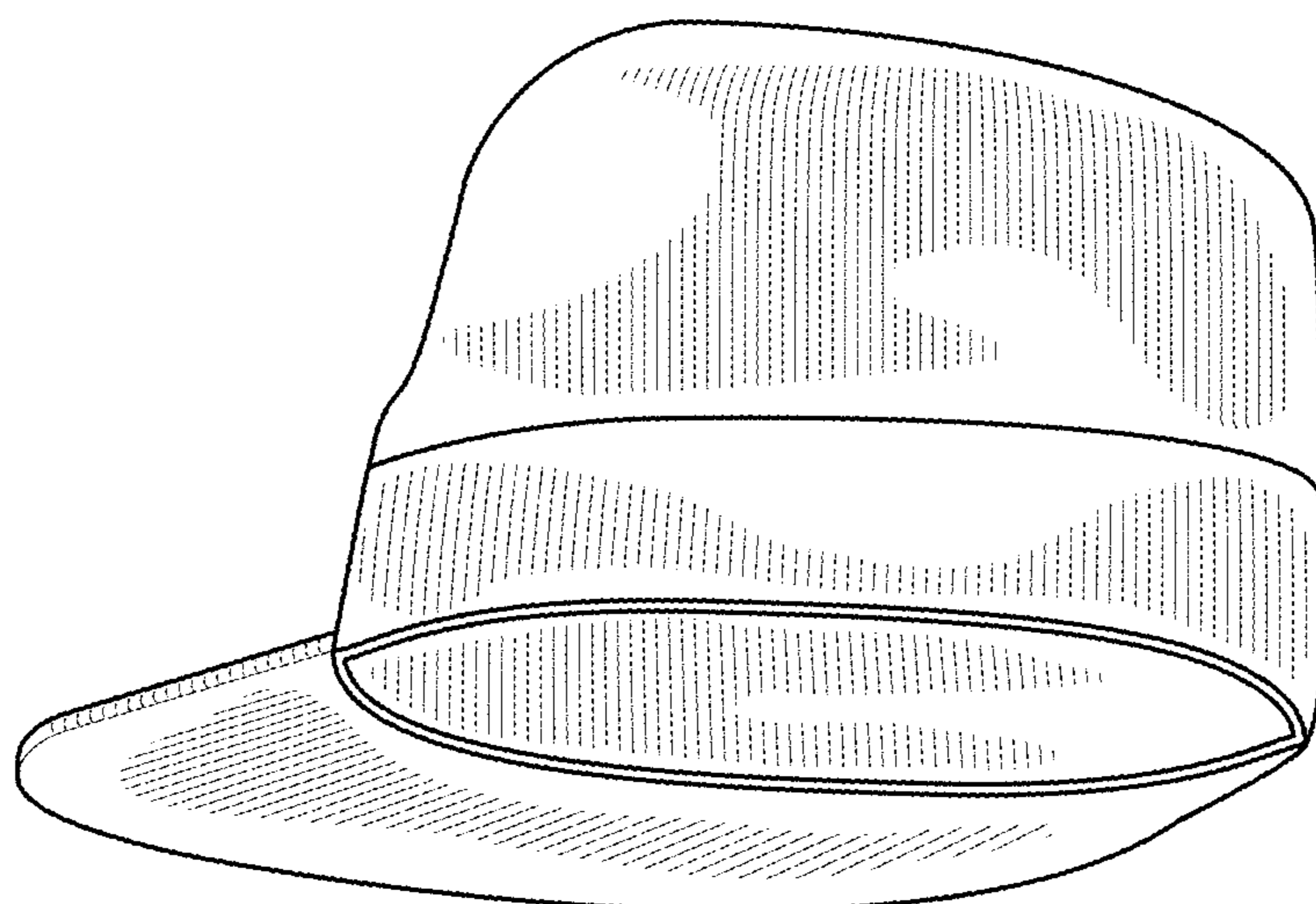

FIG. 2

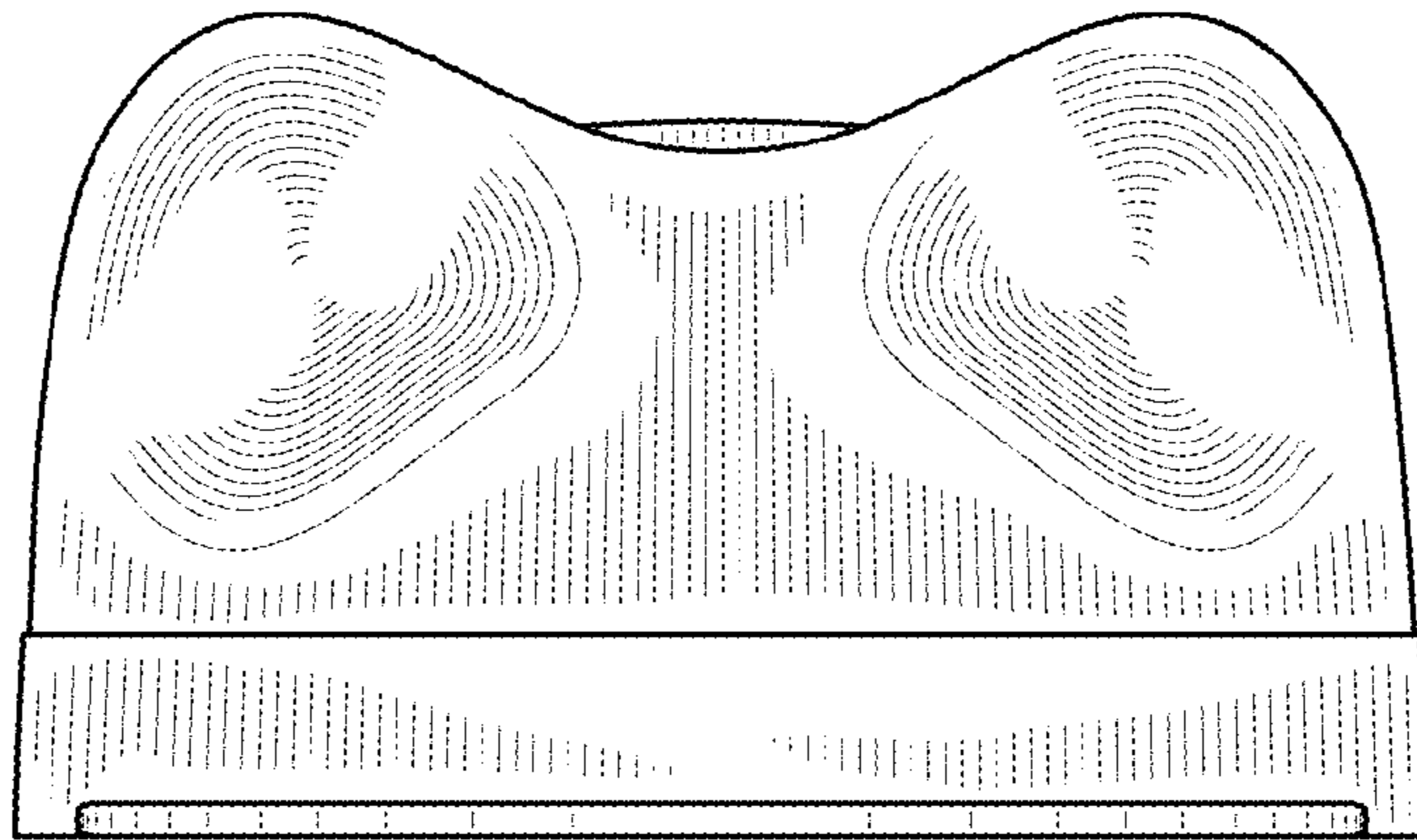

FIG. 3

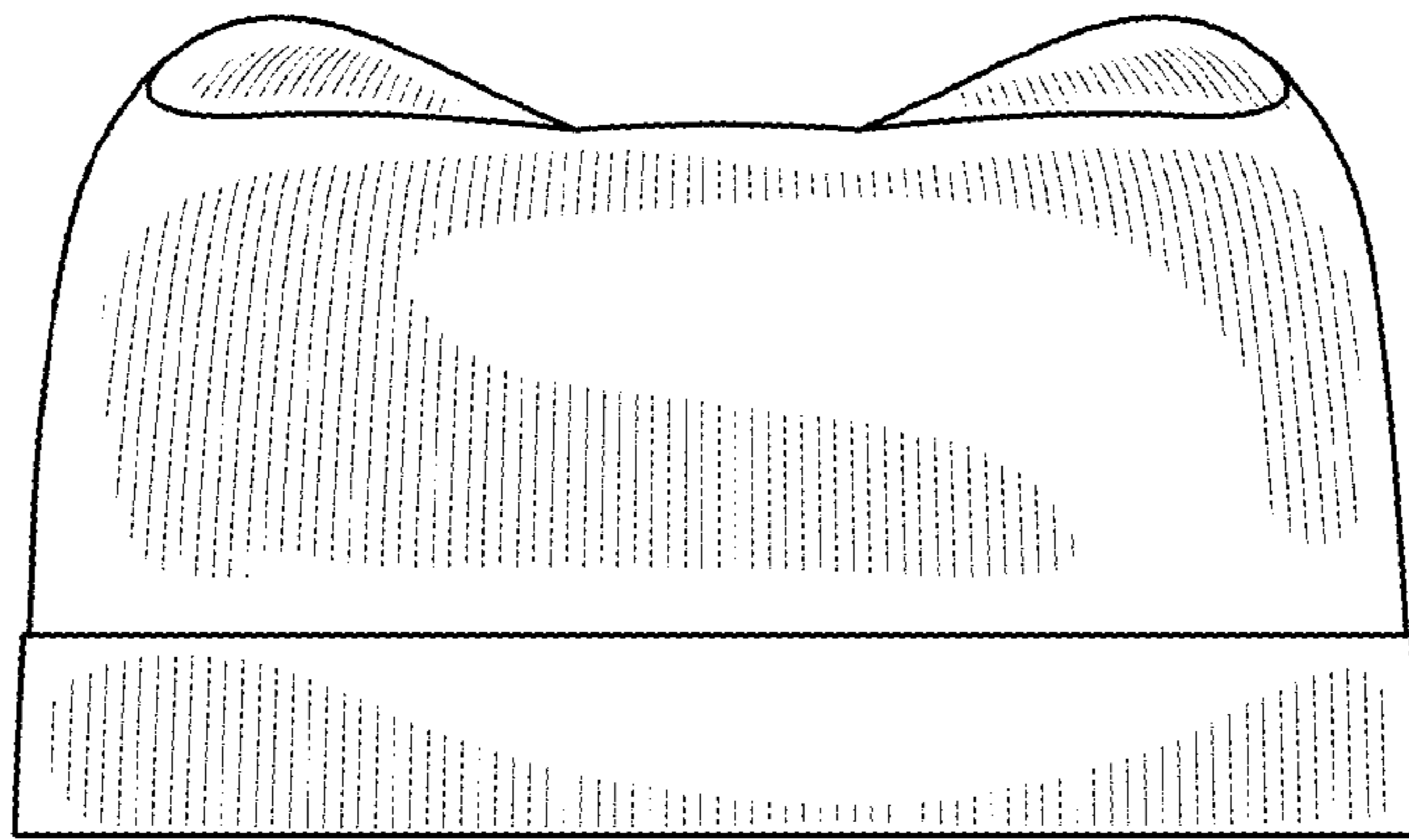

FIG. 4

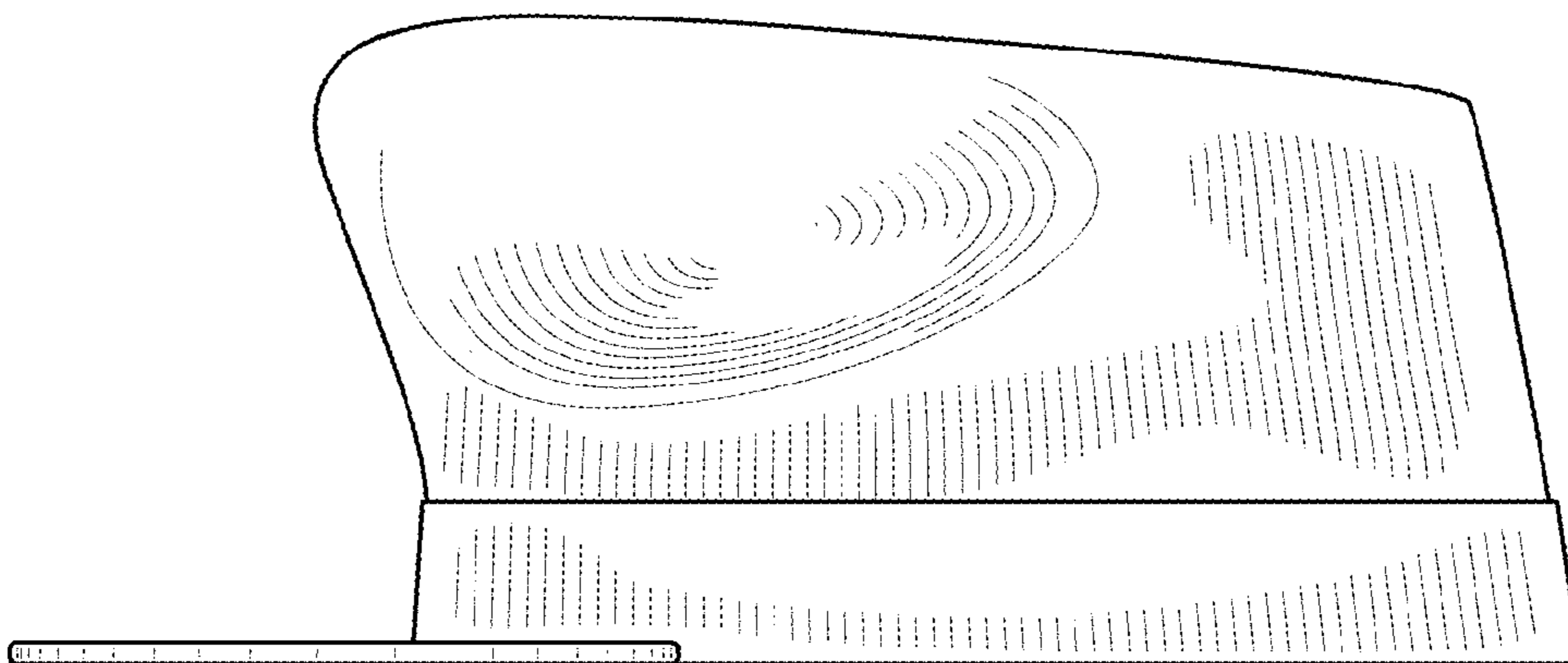

FIG. 5

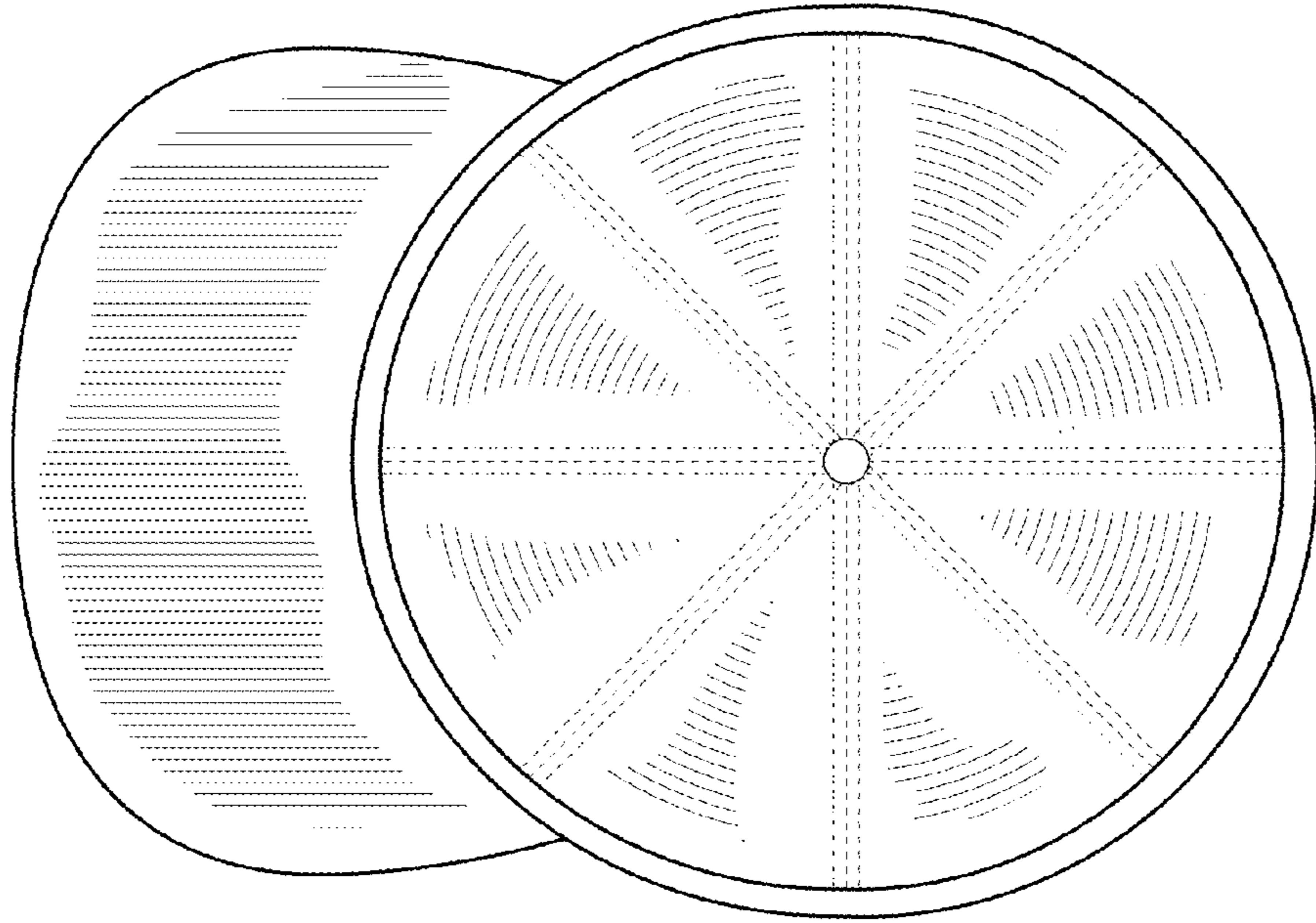

FIG. 7

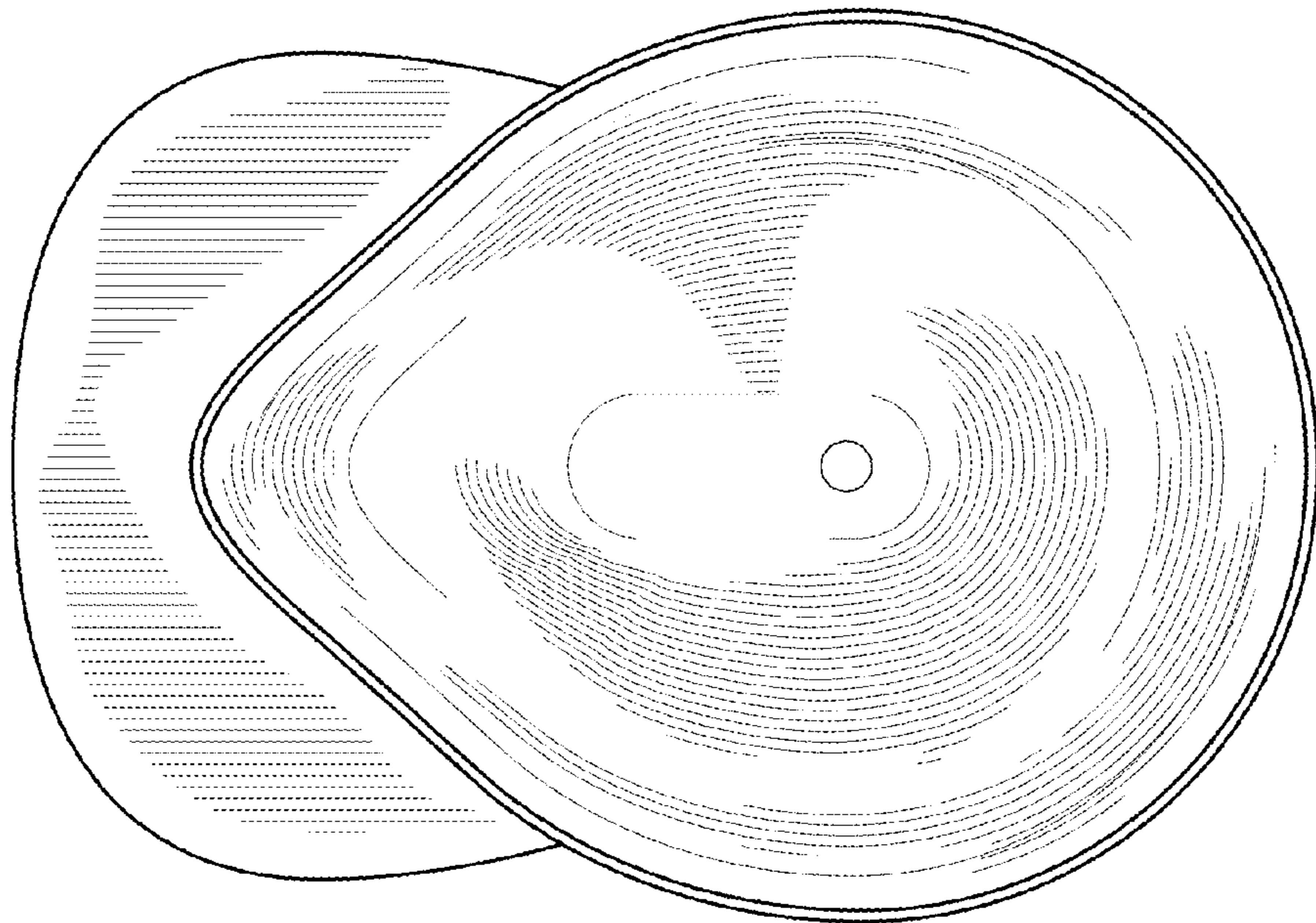

FIG. 6

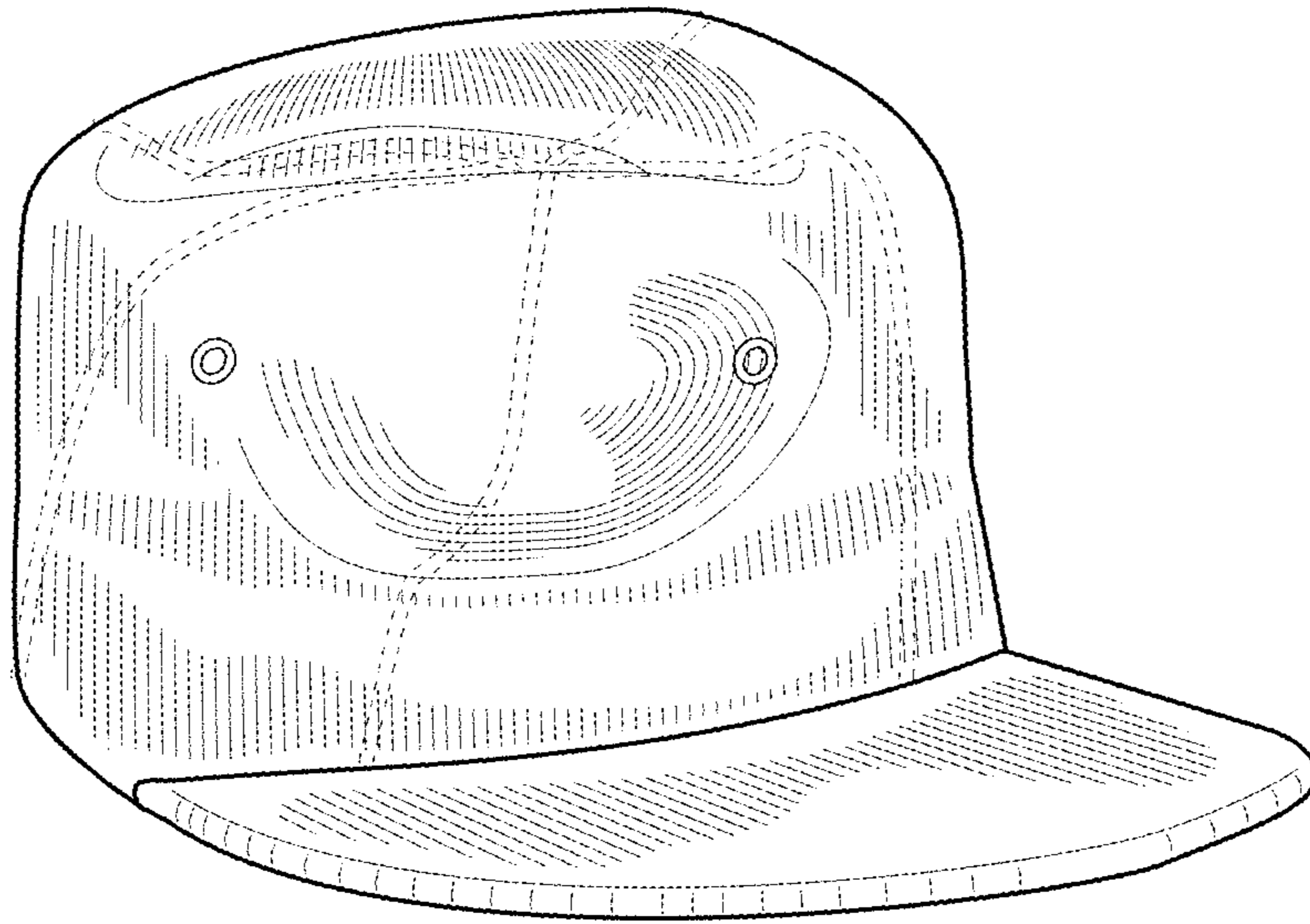

FIG. 8

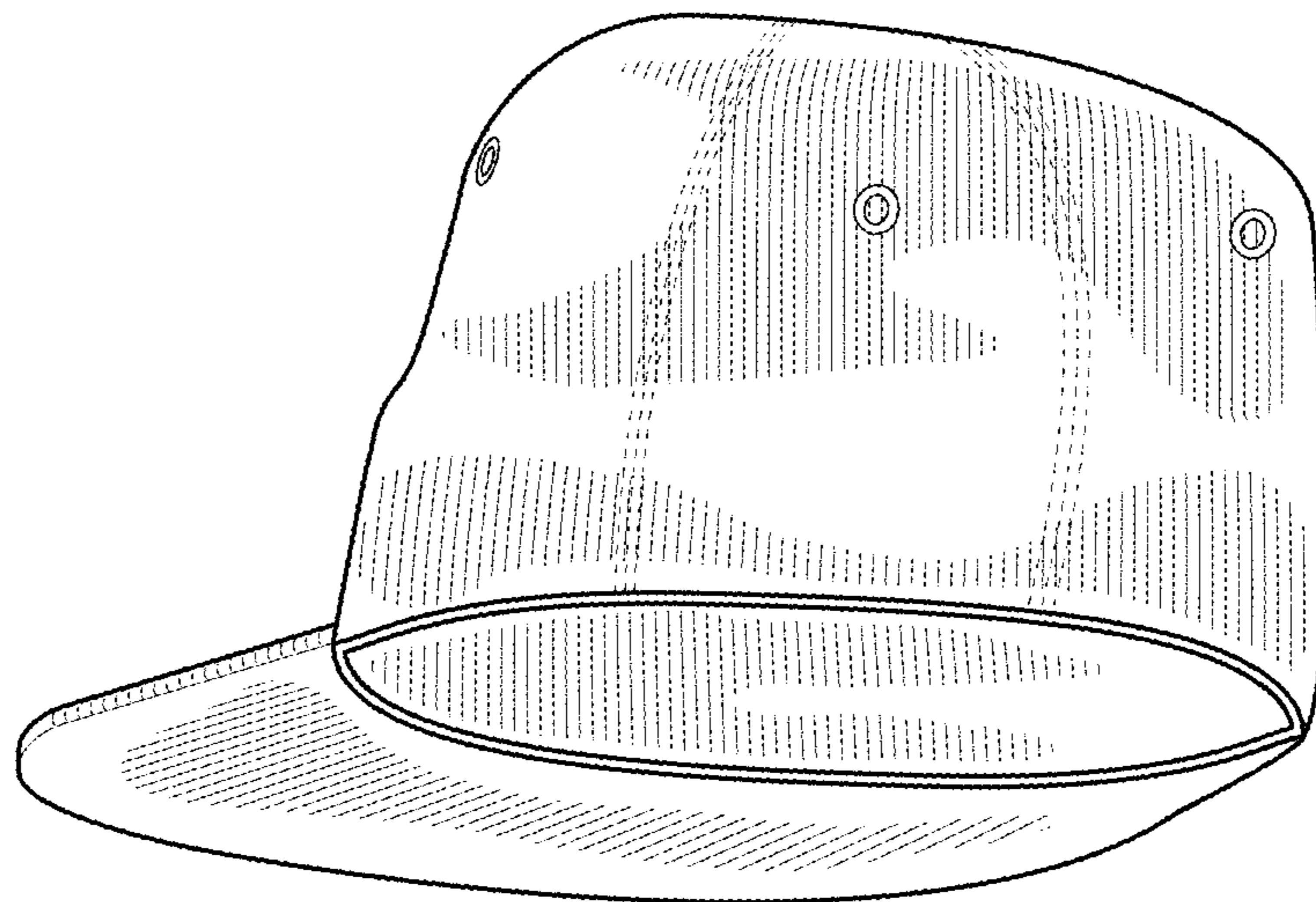

FIG. 9

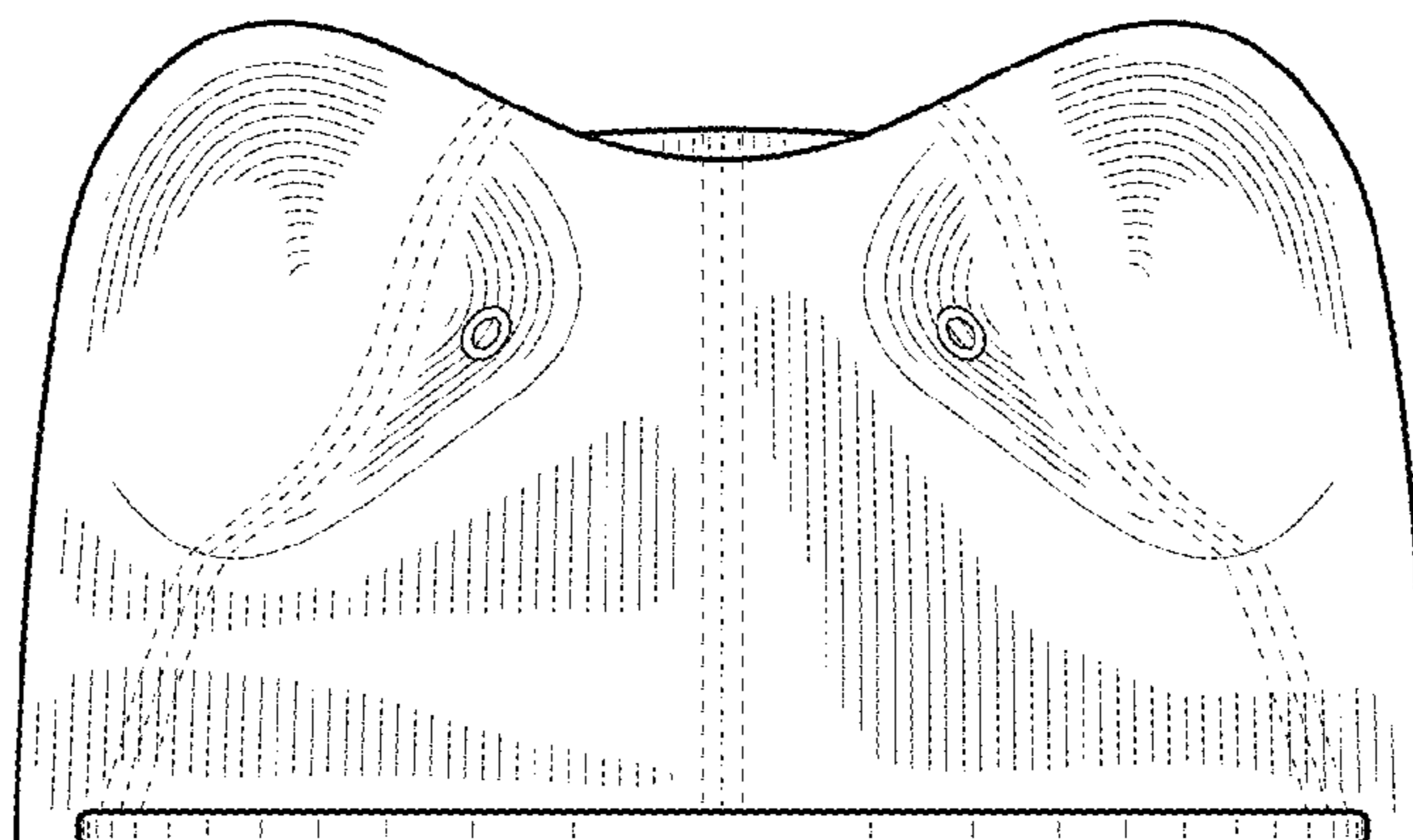

FIG. 10

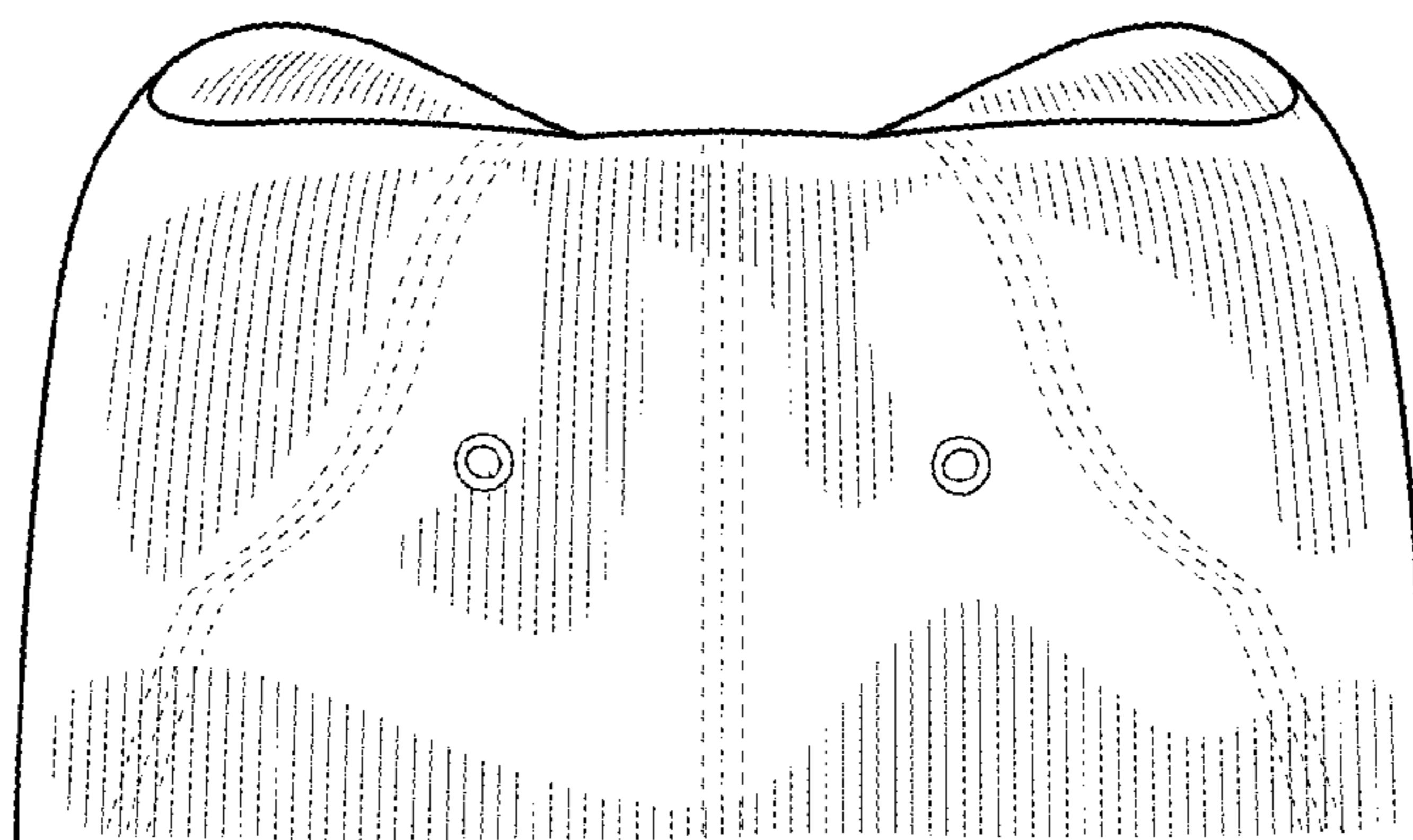

FIG. 11

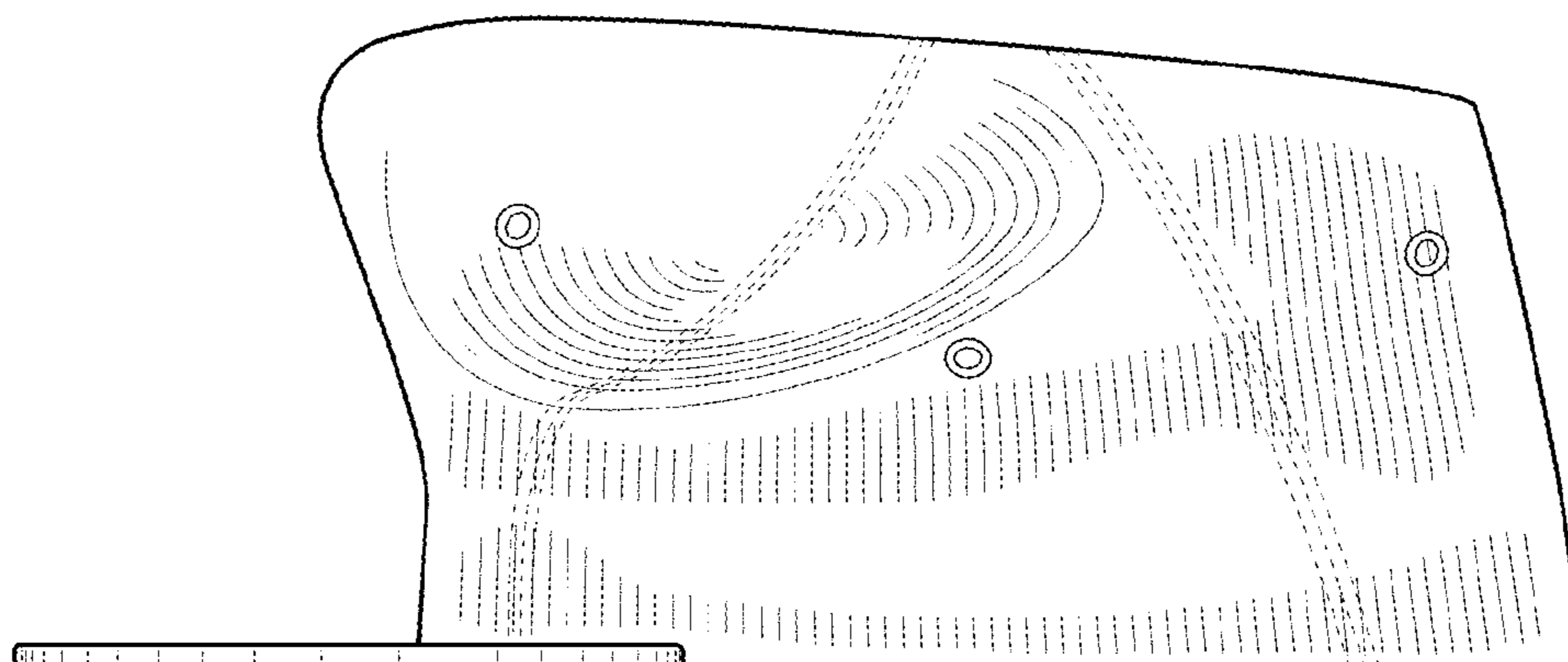

FIG. 12

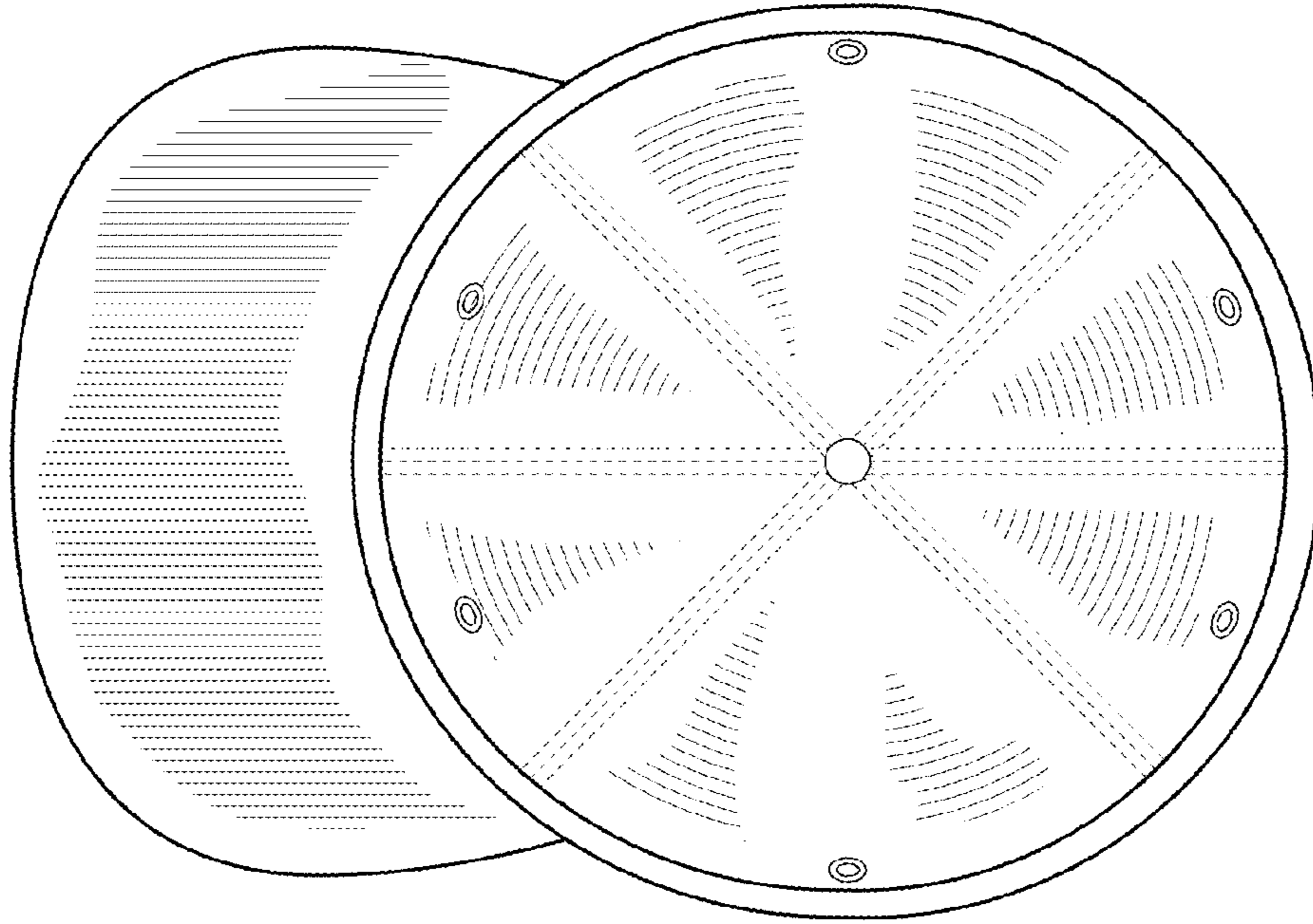

FIG. 14

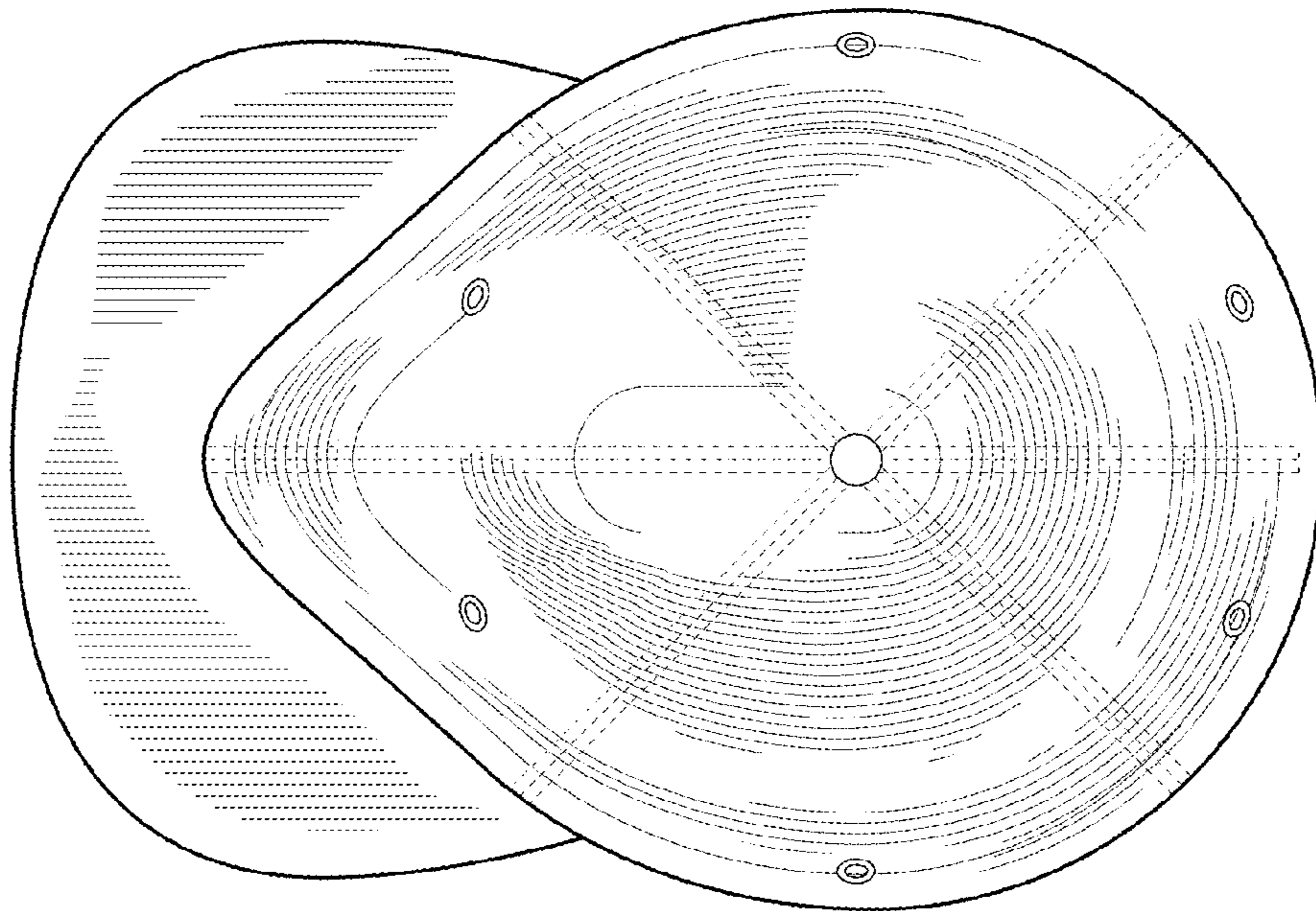

FIG. 13