



US00D702886S

(12) **United States Design Patent**
Bohman

(10) **Patent No.:** **US D702,886 S**

(45) **Date of Patent:** **** Apr. 15, 2014**

(54) **CURLING IRON HOLDER**

(71) Applicant: **Dione Ely Bohman**, Ringle, WI (US)

(72) Inventor: **Dione Ely Bohman**, Ringle, WI (US)

(**) Term: **14 Years**

(21) Appl. No.: **29/441,145**

(22) Filed: **Jan. 1, 2013**

(51) **LOC (10) Cl.** **28-03**

(52) **U.S. Cl.**
USPC **D28/73; D28/38; D6/567**

(58) **Field of Classification Search**
USPC 248/117.1–117.7, 249, 302, 176.2;
D8/373; D28/38, 73; D6/567, 570
See application file for complete search history.

(56) **References Cited**

U.S. PATENT DOCUMENTS

D280,582	S	*	9/1985	DelGarbino et al.	D6/562
4,583,647	A	*	4/1986	Schinzing	211/60.1
4,871,074	A	*	10/1989	Bryson et al.	211/26
4,973,019	A	*	11/1990	Baird et al.	248/314
D347,538	S	*	6/1994	Fleischer	D6/567
D403,869	S	*	1/1999	Harmon et al.	D6/320
D410,767	S	*	6/1999	Carroll	D28/73

D428,533	S	*	7/2000	Carroll	D28/73
D555,466	S	*	11/2007	Hennig	D8/373
D584,857	S	*	1/2009	Kirschenmann	D28/73
D608,054	S	*	1/2010	Radfar	D28/73
2004/0099624	A1	*	5/2004	Hein	211/89.01
2007/0210021	A1	*	9/2007	Whitehead et al.	211/70.6

* cited by examiner

Primary Examiner — Jennifer Rivard

(74) *Attorney, Agent, or Firm* — Steven H. Greenfield;
Greenfield Invention and Patent Consulting, Inc.

(57) **CLAIM**

The ornamental design for a curling iron holder, as shown and described.

DESCRIPTION

FIG. 1 is a top perspective view of an ornamental curling iron holder showing my new design;
FIG. 2 is a bottom perspective view thereof;
FIG. 3 is a rear perspective view thereof;
FIG. 4 is a front view thereof;
FIG. 5 is a rear view thereof;
FIG. 6 is a top view thereof;
FIG. 7 is a bottom view thereof;
FIG. 8 is a first side view thereof; and,
FIG. 9 is a second side view thereof.

1 Claim, 9 Drawing Sheets

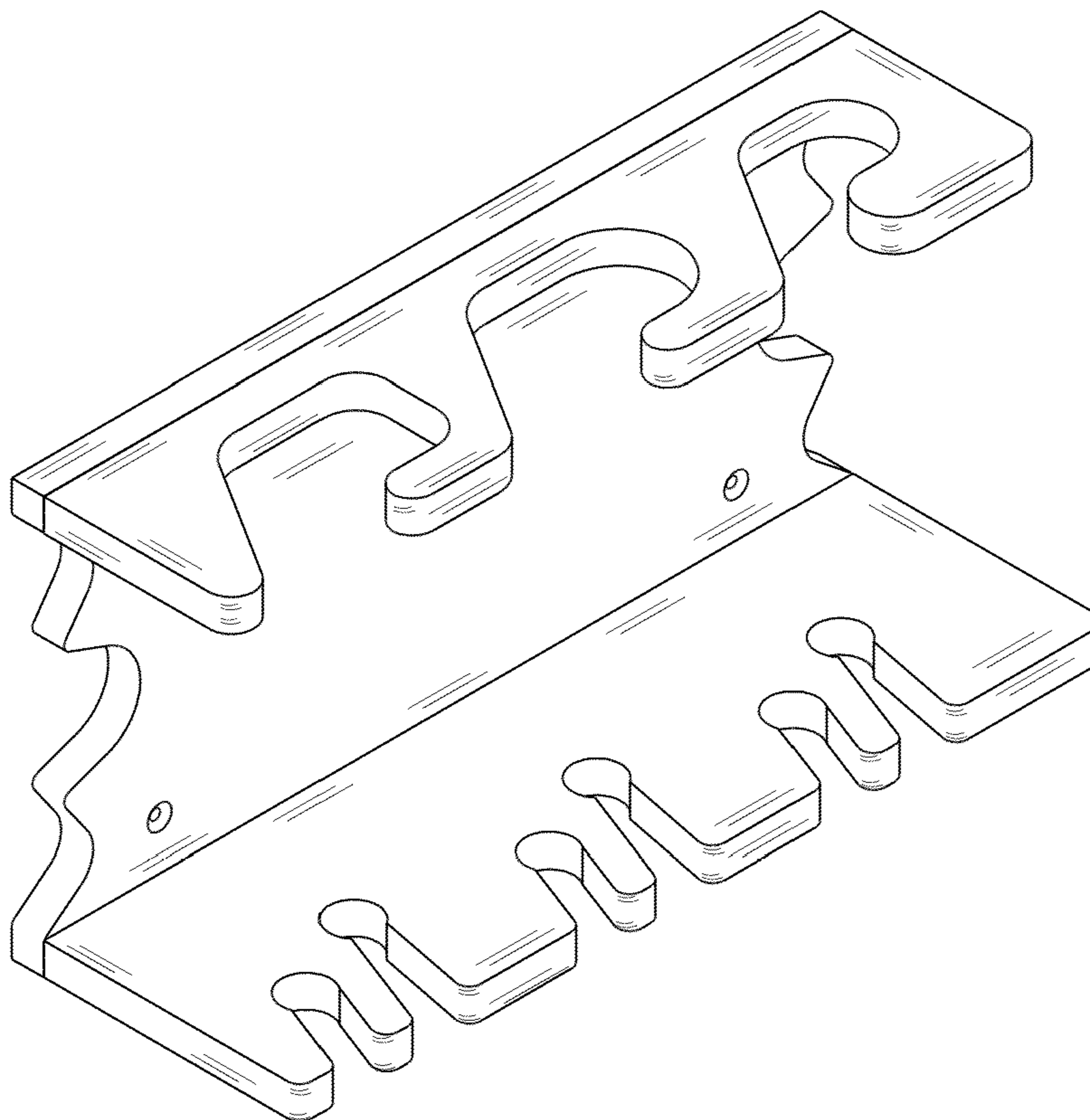

FIG. 1

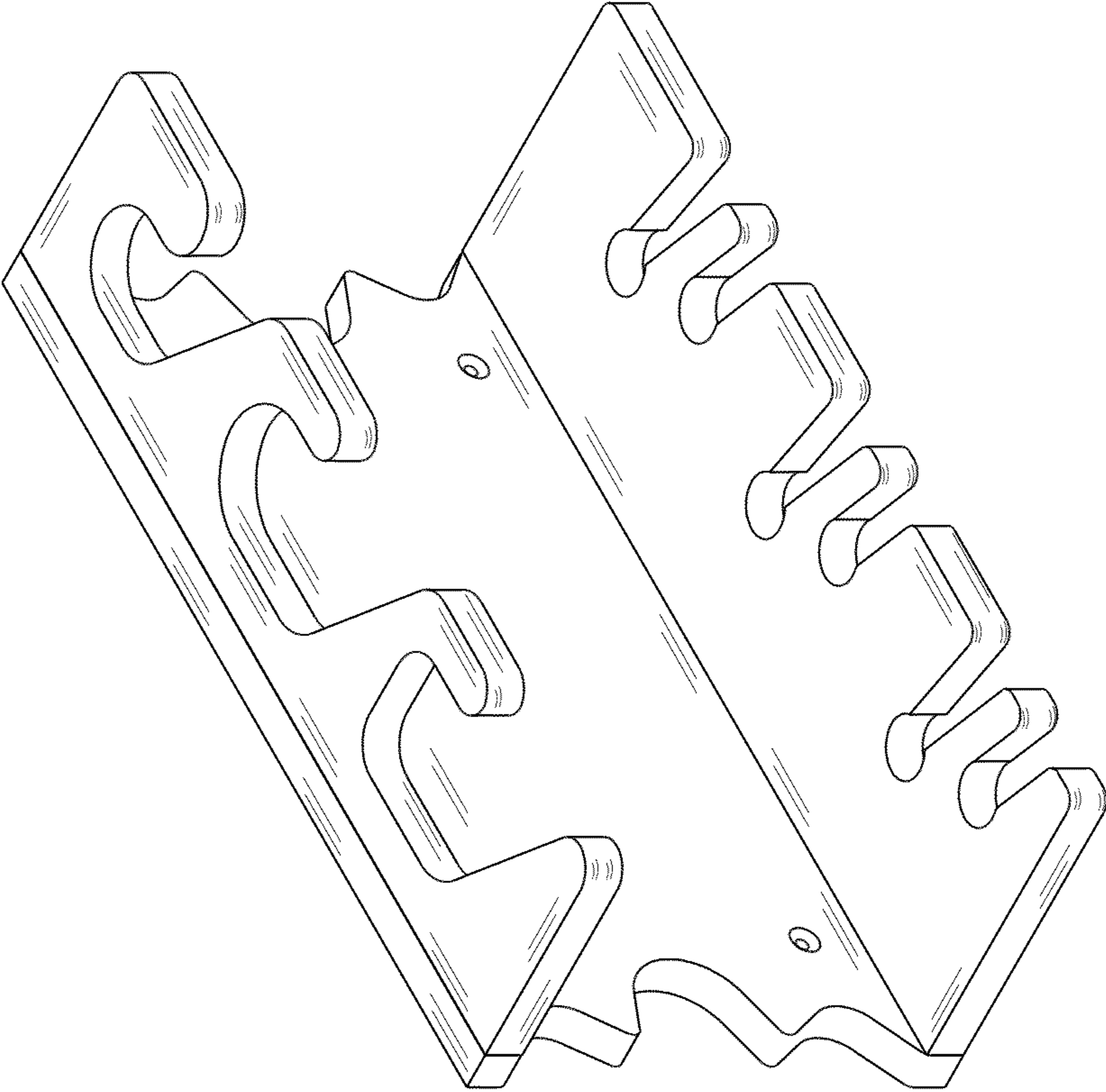

FIG. 2

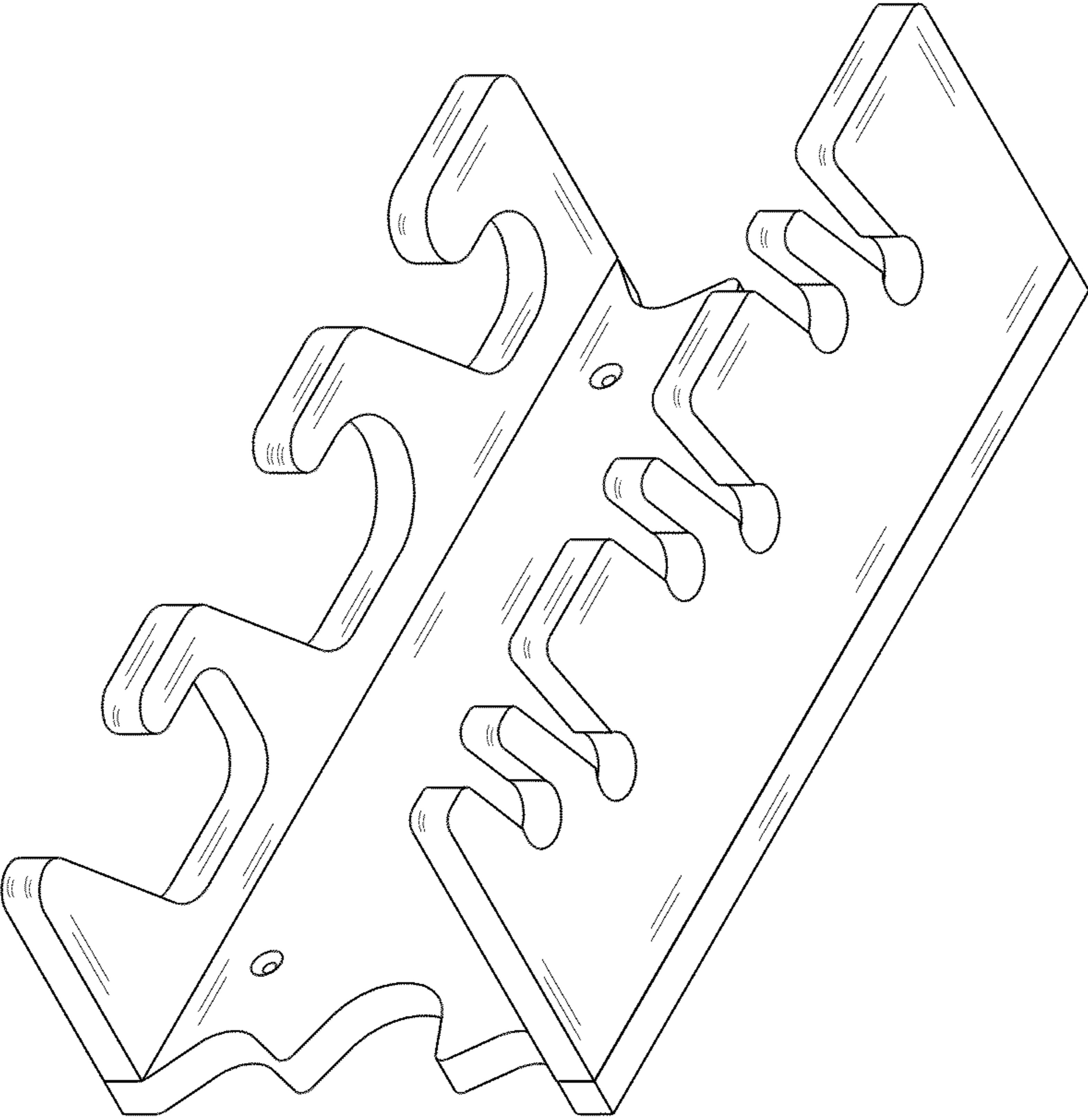

FIG. 3

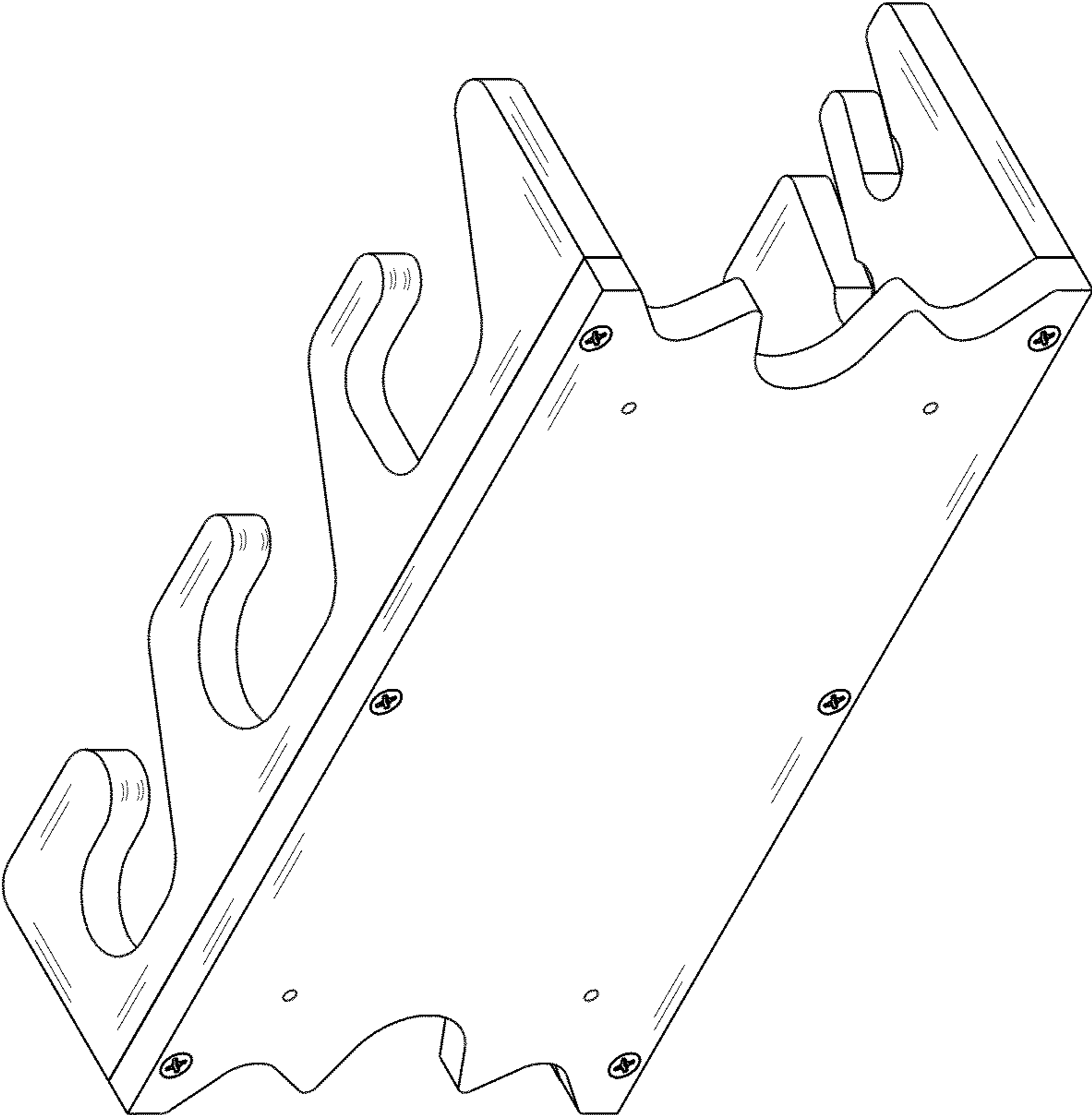

FIG. 4

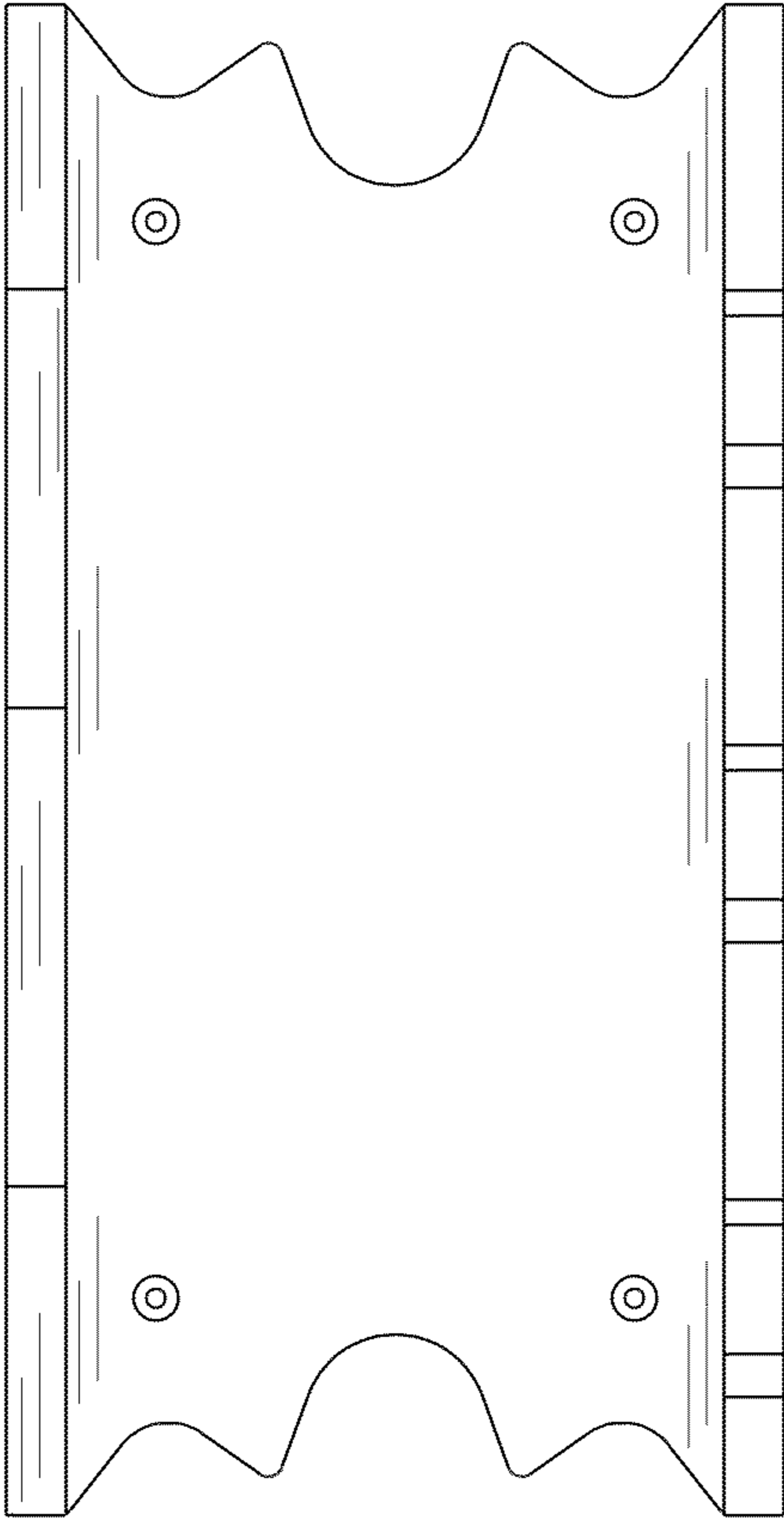

FIG. 5

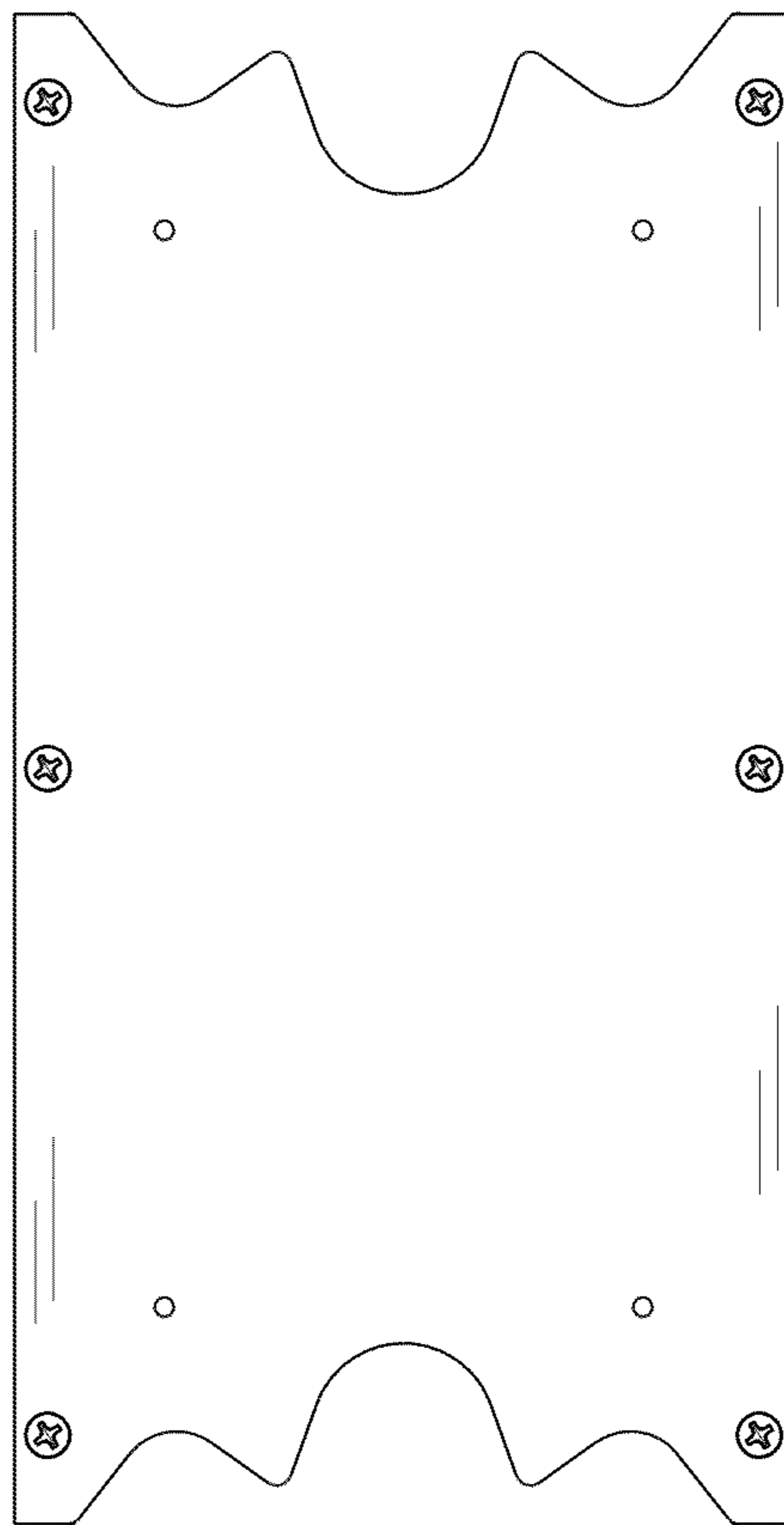

FIG. 6

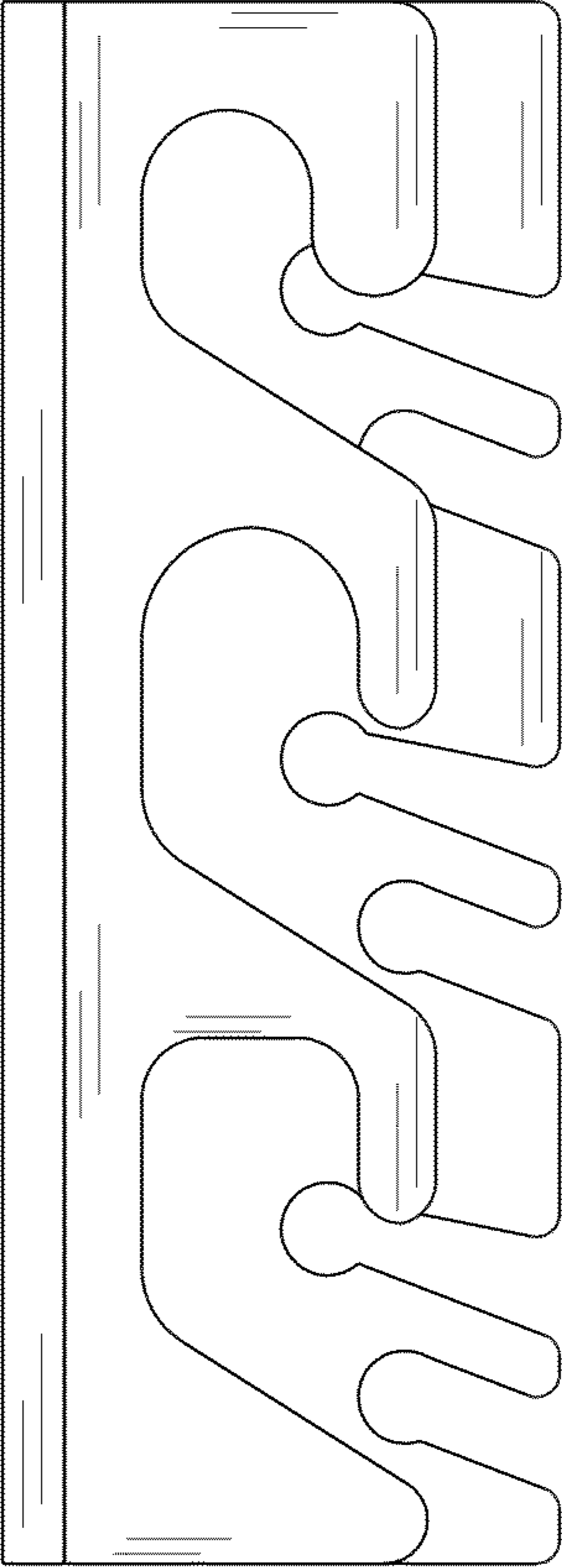

FIG. 7

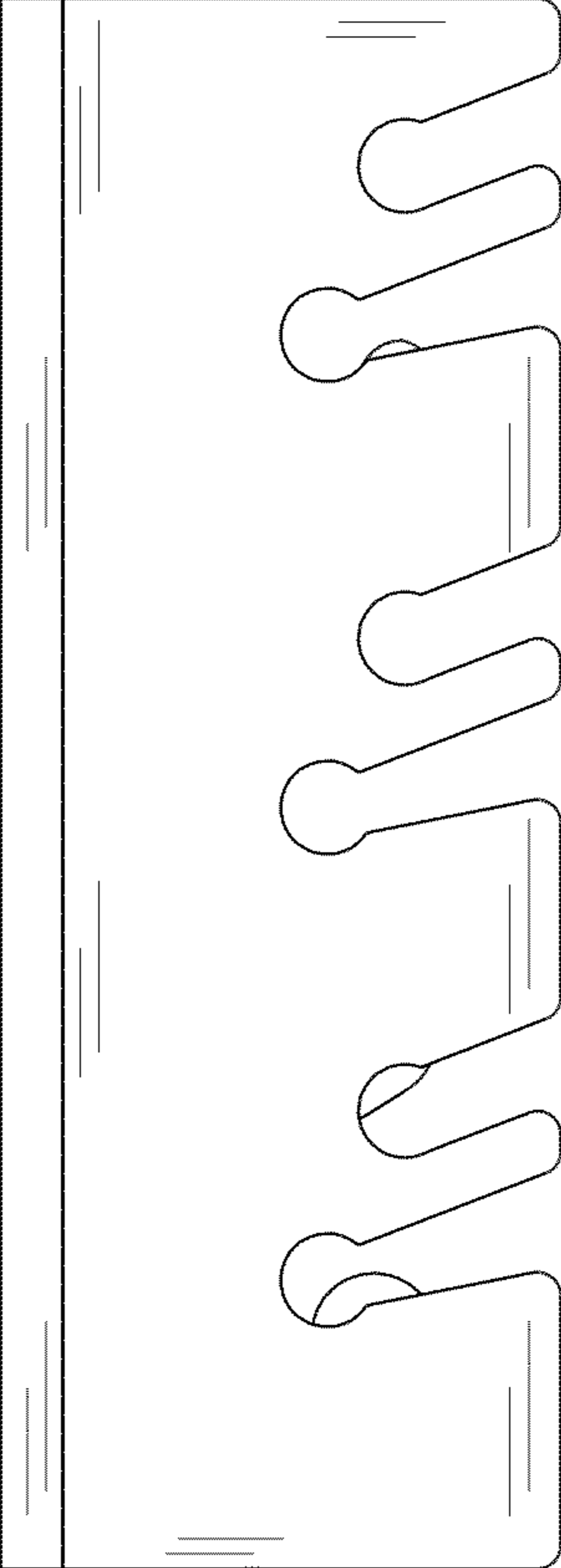

FIG. 8

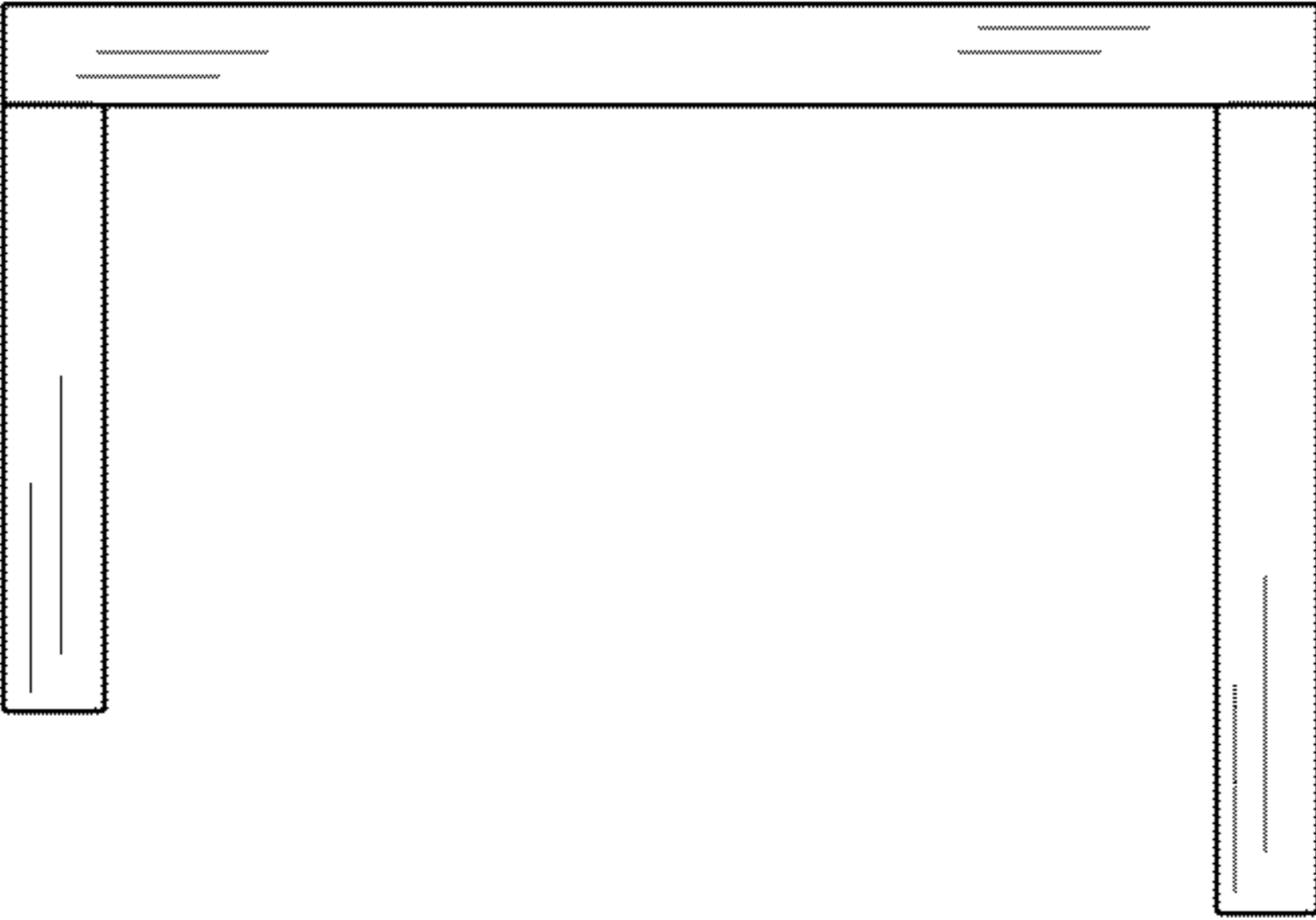

FIG. 9

