



US00D702804S

(12) **United States Design Patent**  
**King**

(10) **Patent No.:** **US D702,804 S**  
(45) **Date of Patent:** **\*\* Apr. 15, 2014**

- (54) **INSECT BAIT STAKE**
- (71) Applicant: **Woodstream Corporation**, Lititz, PA (US)
- (72) Inventor: **Andrew N. King**, Lititz, PA (US)
- (73) Assignee: **Woodstream Corporation**, Lititz, PA (US)

5,379,545 A	1/1995	Gall et al.	
5,528,854 A	6/1996	Antonali et al.	
D400,635 S	11/1998	Kinzler et al.	
5,870,853 A	2/1999	Williams	
6,003,266 A *	12/1999	Woodruff	43/124
6,016,625 A	1/2000	Bishoff et al.	
6,065,241 A *	5/2000	Woodruff	43/132.1
6,474,016 B2 *	11/2002	Snell et al.	43/131
6,964,124 B2 *	11/2005	Brode et al.	43/132.1
7,540,111 B2	6/2009	Kraatz	
7,937,886 B2 *	5/2011	Bernard	43/131

(\*\*) Term: **14 Years**

\* cited by examiner

(21) Appl. No.: **29/455,193**

*Primary Examiner* — Catheri Oliver-Garcia

(22) Filed: **May 17, 2013**

(74) *Attorney, Agent, or Firm* — Jacobson Holman PLLC

(51) **LOC (10) Cl.** ..... **22-06**

(57) **CLAIM**

(52) **U.S. Cl.**  
USPC ..... **D22/122**

The ornamental design for an insect bait stake, as shown and described.

(58) **Field of Classification Search**  
USPC ..... D22/119–124; 43/1, 58, 60, 107,  
43/112–113, 124, 131, 132.1  
See application file for complete search history.

**DESCRIPTION**

(56) **References Cited**

U.S. PATENT DOCUMENTS

2,547,314 A	4/1951	Grant	
2,825,996 A	3/1958	Grant	
2,837,861 A *	6/1958	Graham, Sr.	43/131
2,893,160 A	7/1959	Grant	
3,828,464 A	8/1974	Peace	
4,065,872 A	1/1978	Patton et al.	

FIG. 1 is a perspective view showing my new design for an insect bait stake,  
FIG. 2 is a front view thereof,  
FIG. 3 is a rear view thereof,  
FIG. 4 is a left side view thereof,  
FIG. 5 is a right side view thereof,  
FIG. 6 is a top view thereof,  
FIG. 7 is a bottom view thereof; and,  
FIG. 8 is another perspective view thereof with a tab portion removed.

**1 Claim, 6 Drawing Sheets**

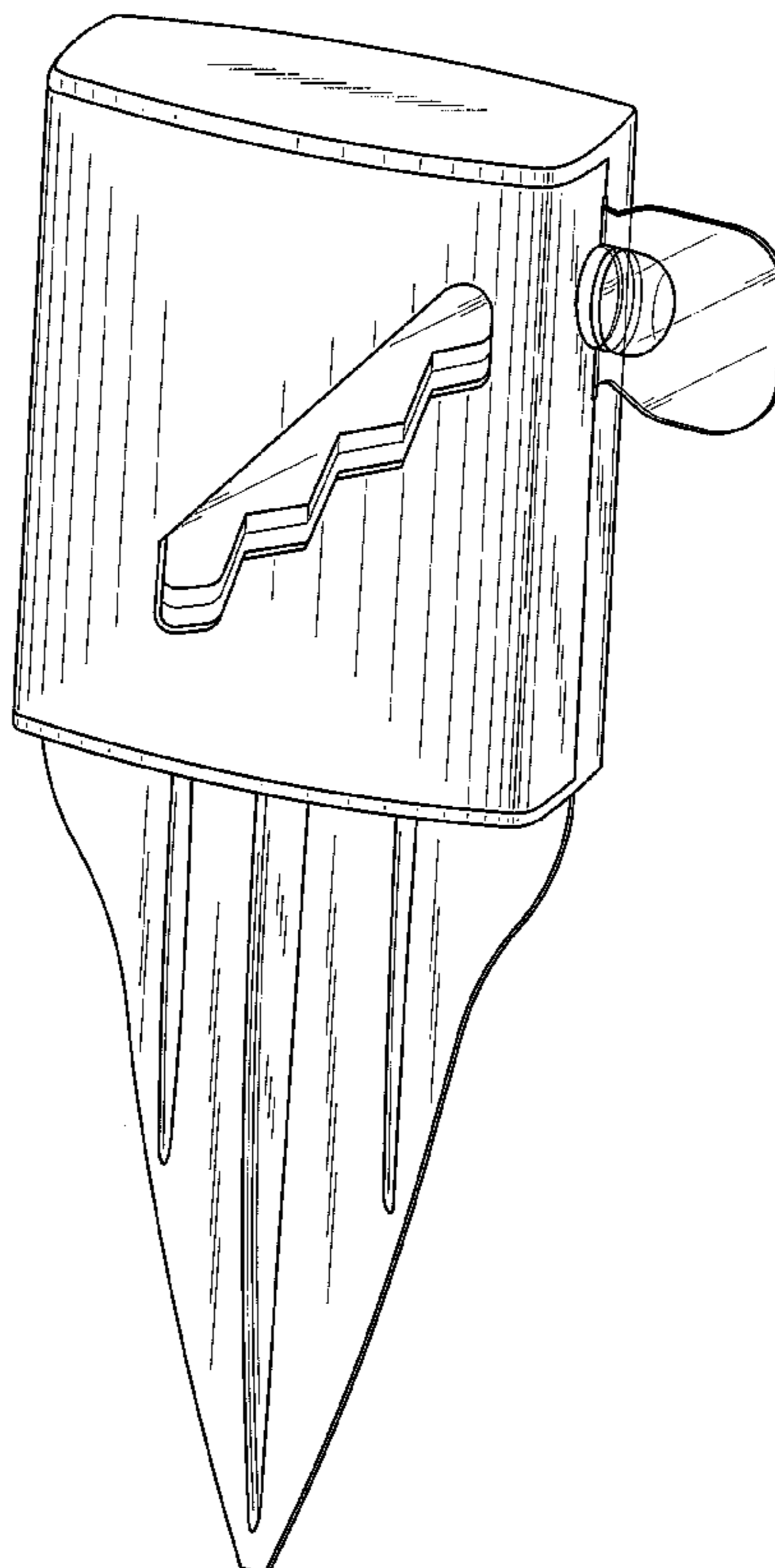

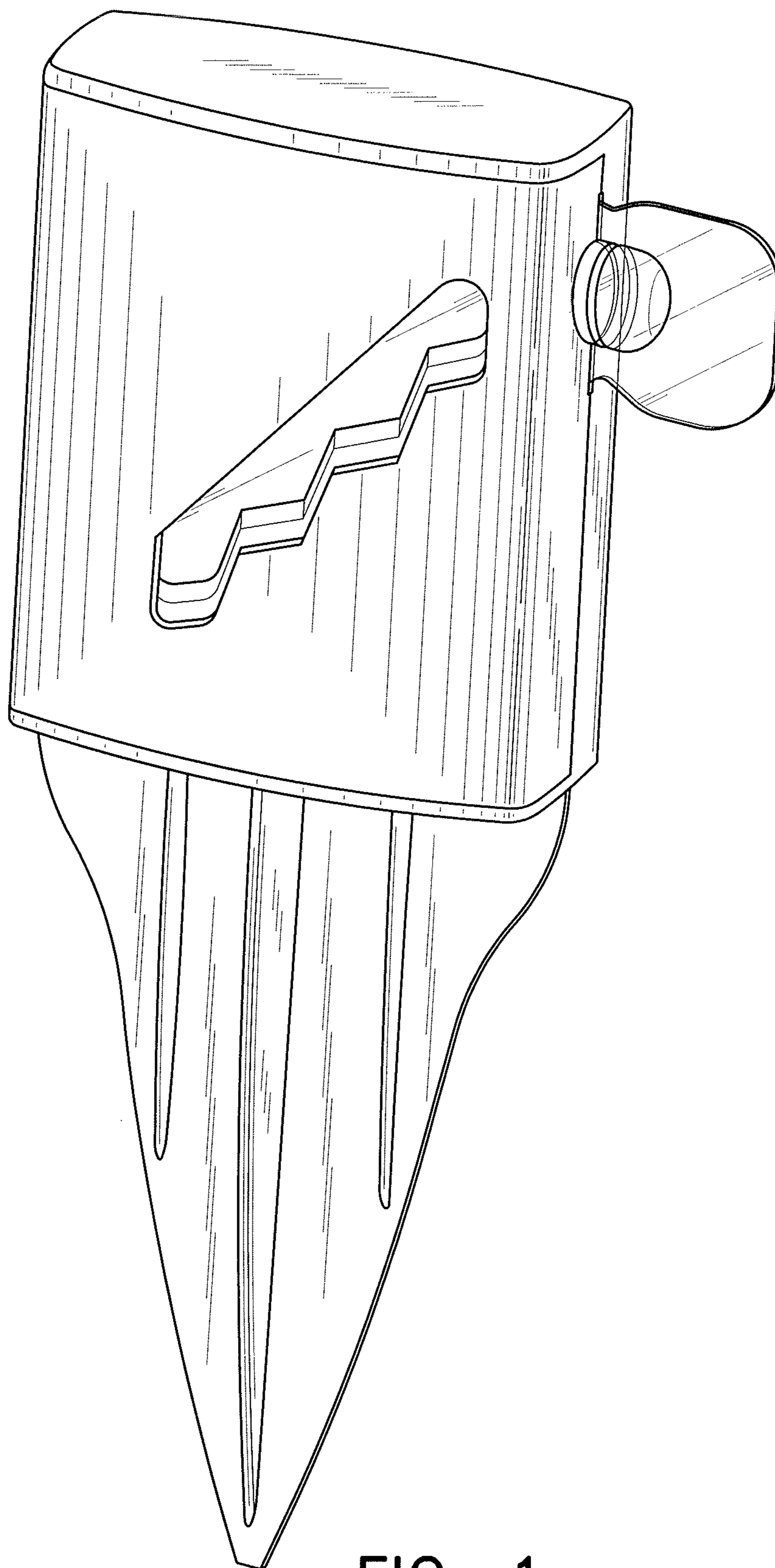

FIG. 1

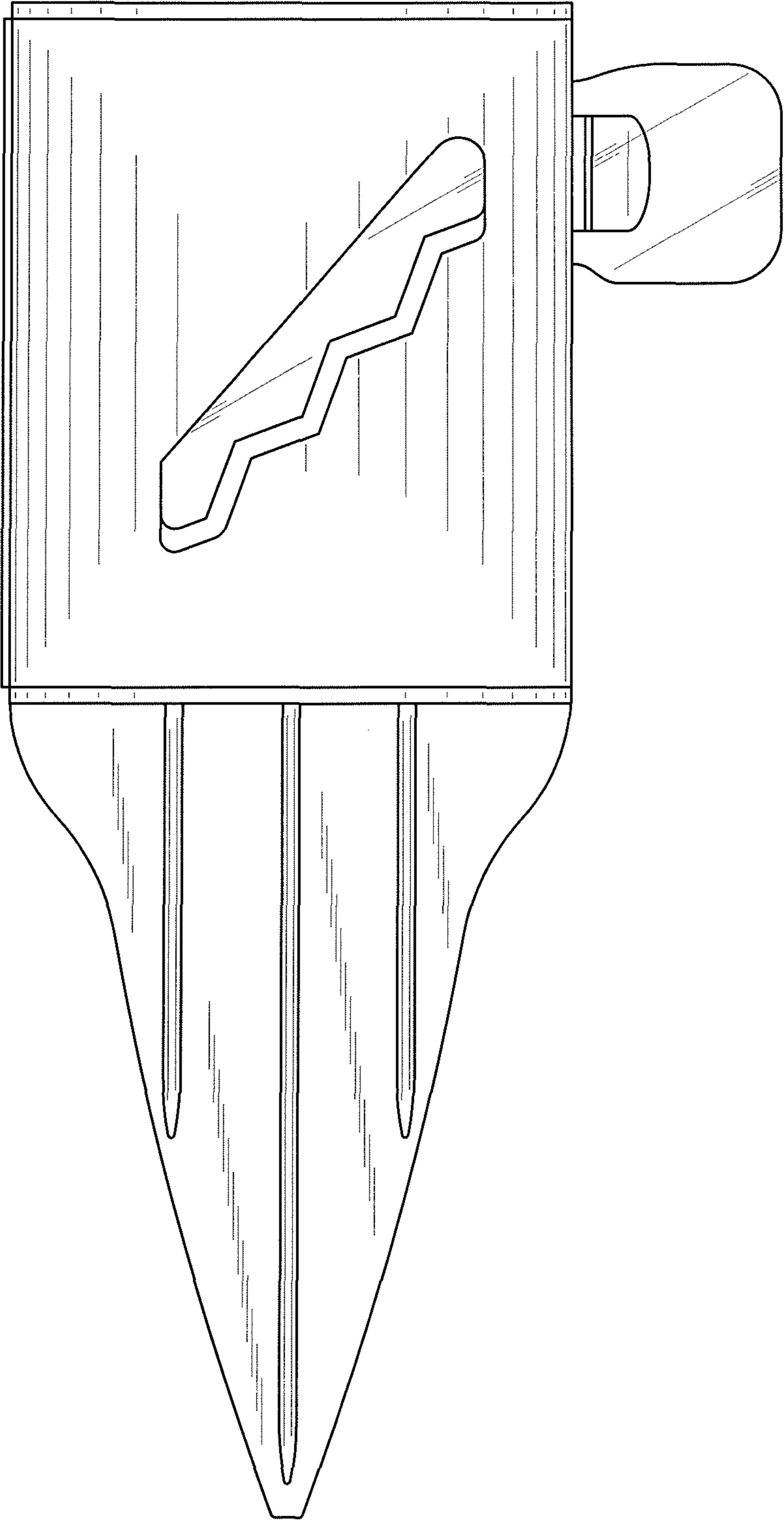

FIG. 2

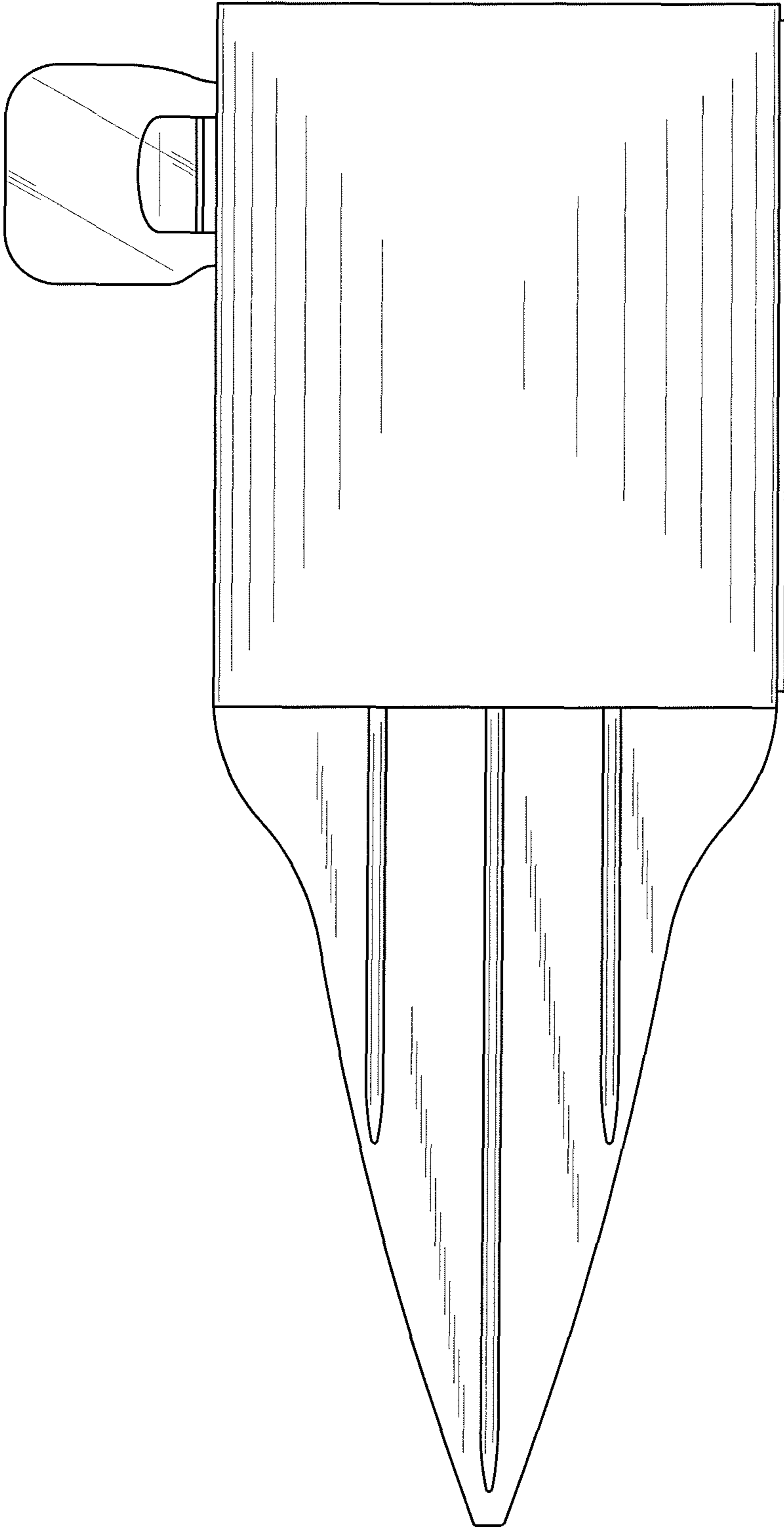

FIG. 3

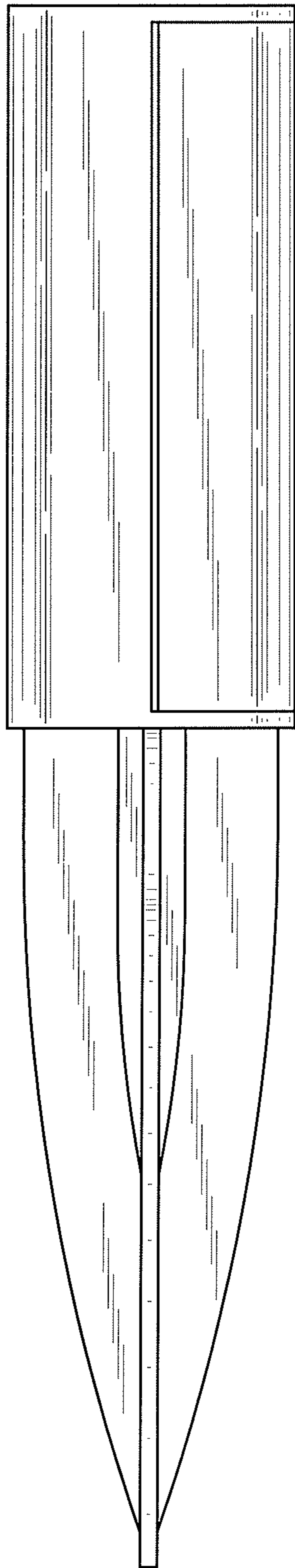

FIG. 4

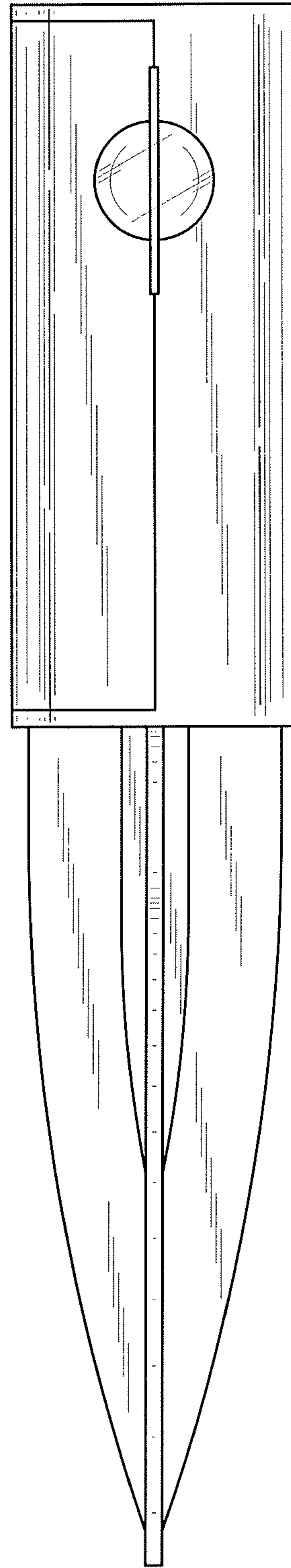

FIG. 5

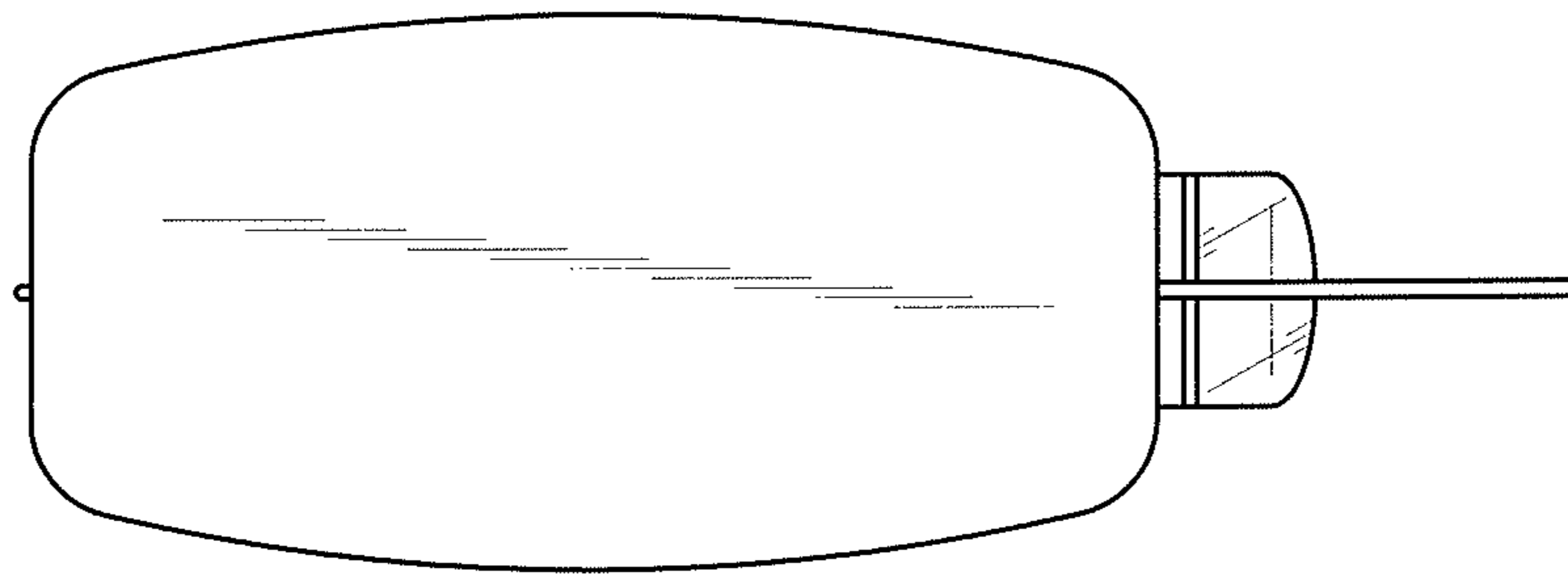

FIG. 6

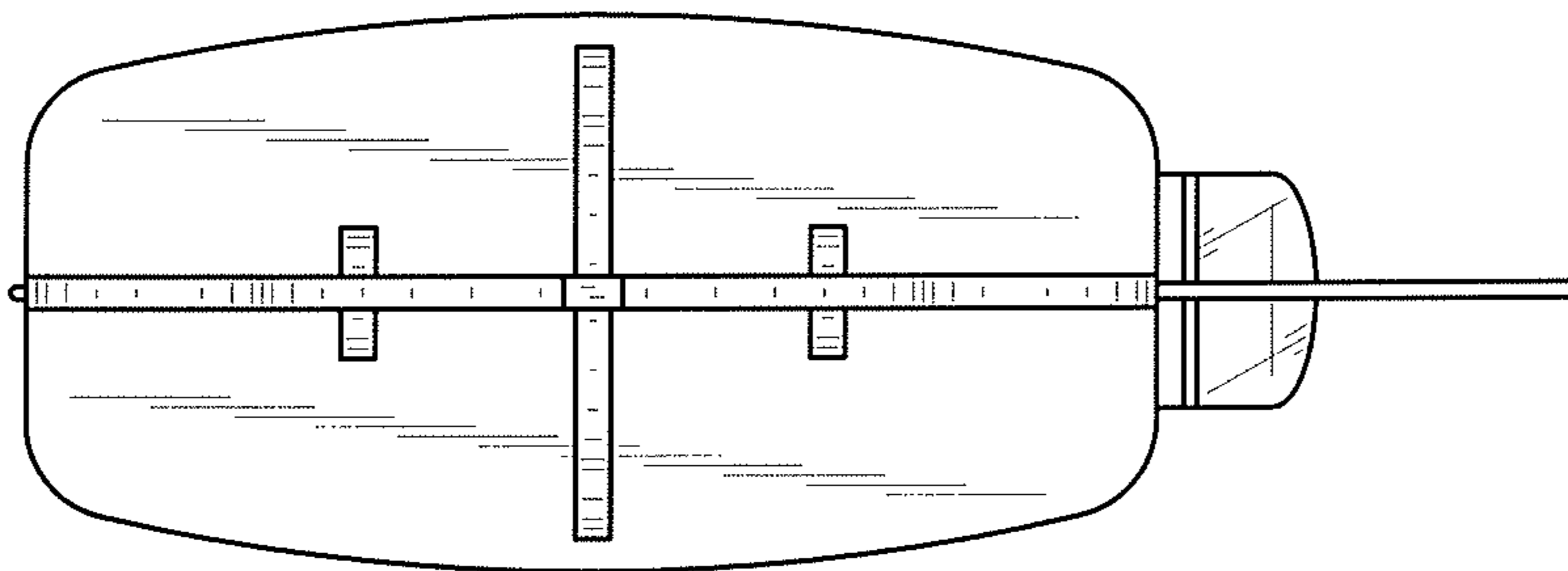

FIG. 7



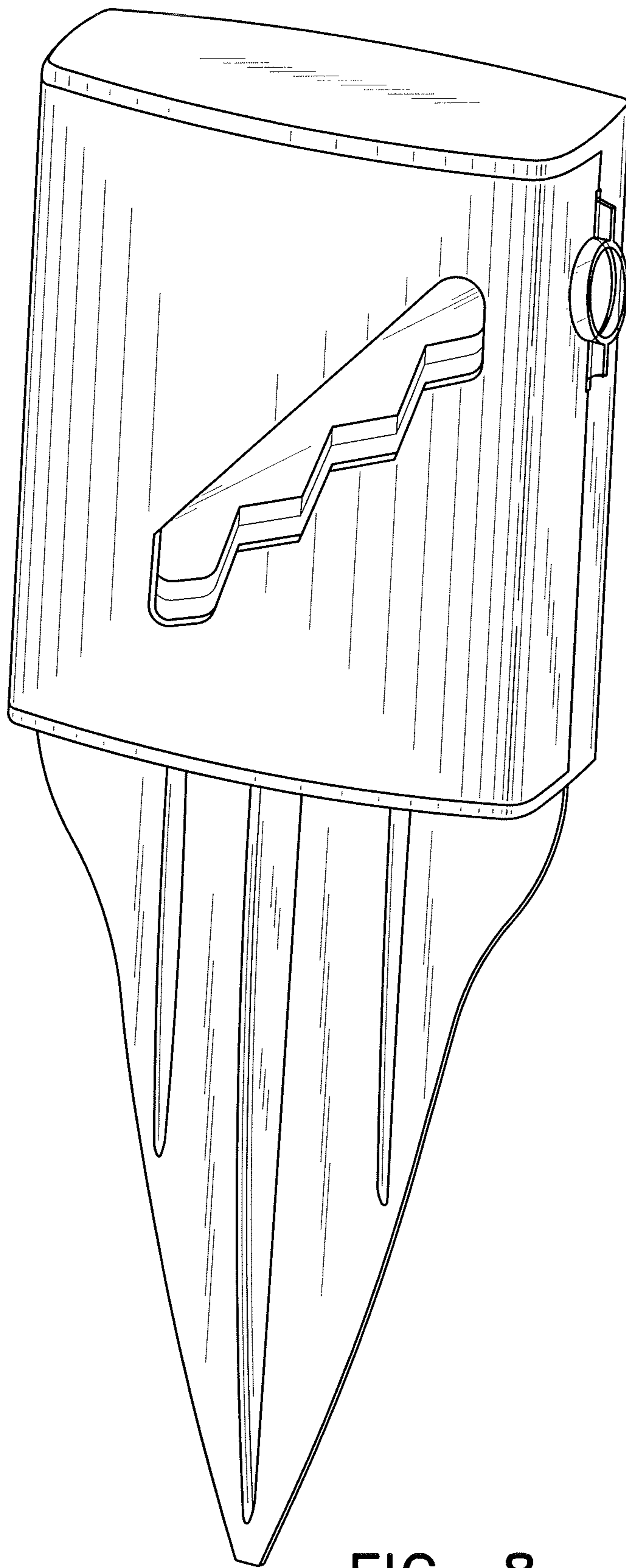

FIG. 8