



US00D702667S

(12) **United States Design Patent**
Yang

(10) **Patent No.:** **US D702,667 S**

(45) **Date of Patent:** **** Apr. 15, 2014**

(54) **EARPHONE**

(71) Applicant: **Bill Yang**, Taipei (TW)

(72) Inventor: **Bill Yang**, Taipei (TW)

(73) Assignee: **Cotron Corporation**, Taipei (TW)

(**) Term: **14 Years**

(21) Appl. No.: **29/451,240**

(22) Filed: **Mar. 29, 2013**

(51) **LOC (10) Cl.** **14-01**

(52) **U.S. Cl.**
CPC **H04R 1/1016** (2013.01)
USPC **D14/223**

(58) **Field of Classification Search**
CPC H04R 1/1016
USPC D14/223; 181/129, 130, 135; 379/430,
379/431; 381/380, 381; 455/90.3, 575.1
See application file for complete search history.

(56) **References Cited**

U.S. PATENT DOCUMENTS

3,821,647	A *	6/1974	Minasian	455/269
5,410,608	A *	4/1995	Lucey et al.	381/360
D519,108	S *	4/2006	Yang	D14/223
D567,217	S *	4/2008	Kamo et al.	D14/205
D587,681	S *	3/2009	Yanai	D14/205
D594,441	S *	6/2009	Lee et al.	D14/205
D598,894	S *	8/2009	Masuda et al.	D14/205

D602,475	S *	10/2009	Martin	D14/223
D631,470	S *	1/2011	Yoneyama et al.	D14/223
D637,181	S *	5/2011	Fuller et al.	D14/223
D643,416	S *	8/2011	Chong et al.	D14/223
D664,951	S *	8/2012	Ang et al.	D14/223
D674,377	S *	1/2013	Schaefer	D14/223
D685,767	S *	7/2013	Kelly et al.	D14/223
D691,580	S *	10/2013	Cho et al.	D14/205
D694,220	S *	11/2013	Lee et al.	D14/223

* cited by examiner

Primary Examiner — Paula Greene

(74) *Attorney, Agent, or Firm* — Jianq Chyun IP Office

(57) **CLAIM**

The ornamental design for an earphone, as shown and described.

DESCRIPTION

FIG. 1 is a perspective view of an earphone showing my new design;

FIG. 2 is another perspective view thereof;

FIG. 3 is a front view thereof;

FIG. 4 is a rear view thereof;

FIG. 5 is a left side view thereof;

FIG. 6 is a right side view thereof;

FIG. 7 is a top view thereof; and,

FIG. 8 is a bottom view thereof.

The broken line portions of the earphone in FIGS. 1-8 represent unclaimed portions of the claimed design and form no part thereof.

1 Claim, 8 Drawing Sheets

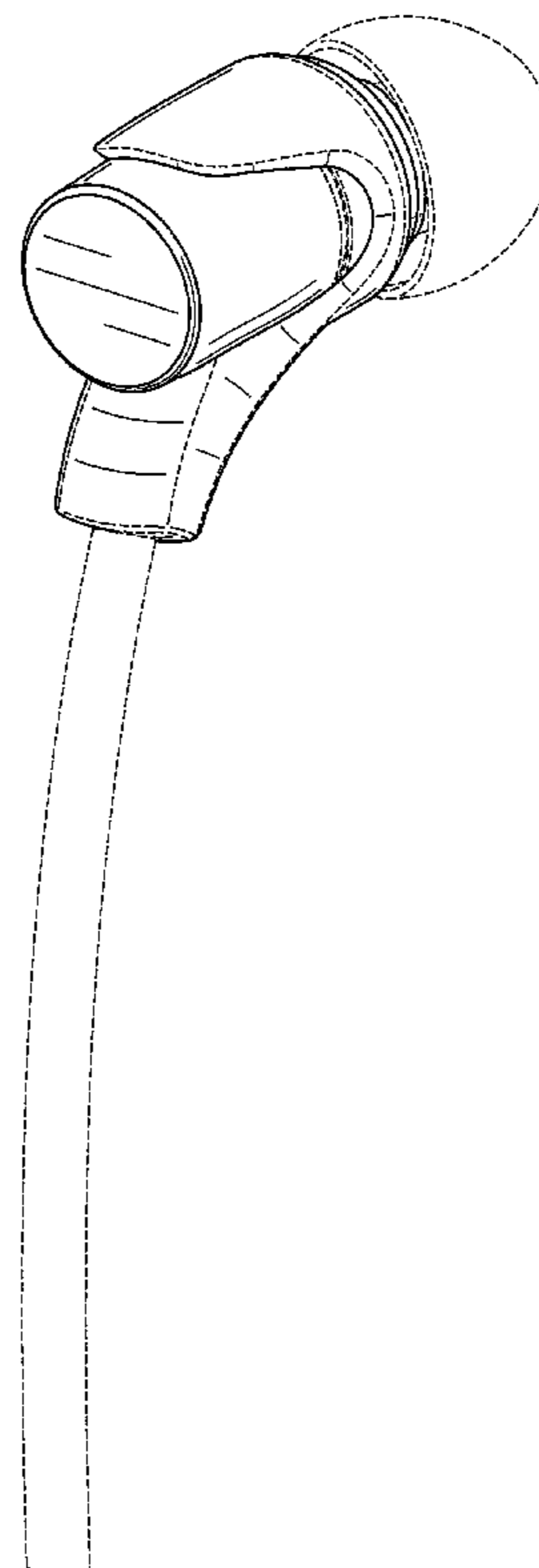
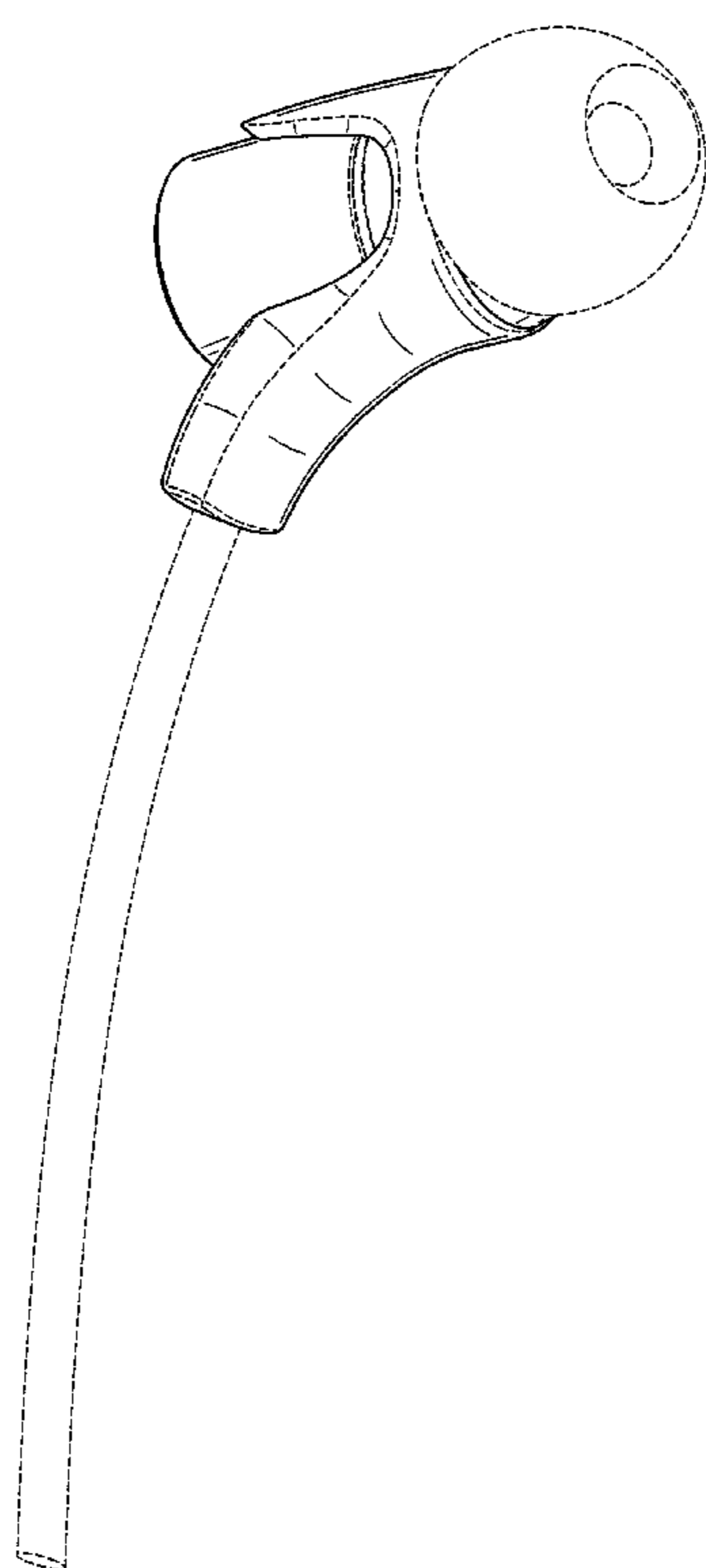

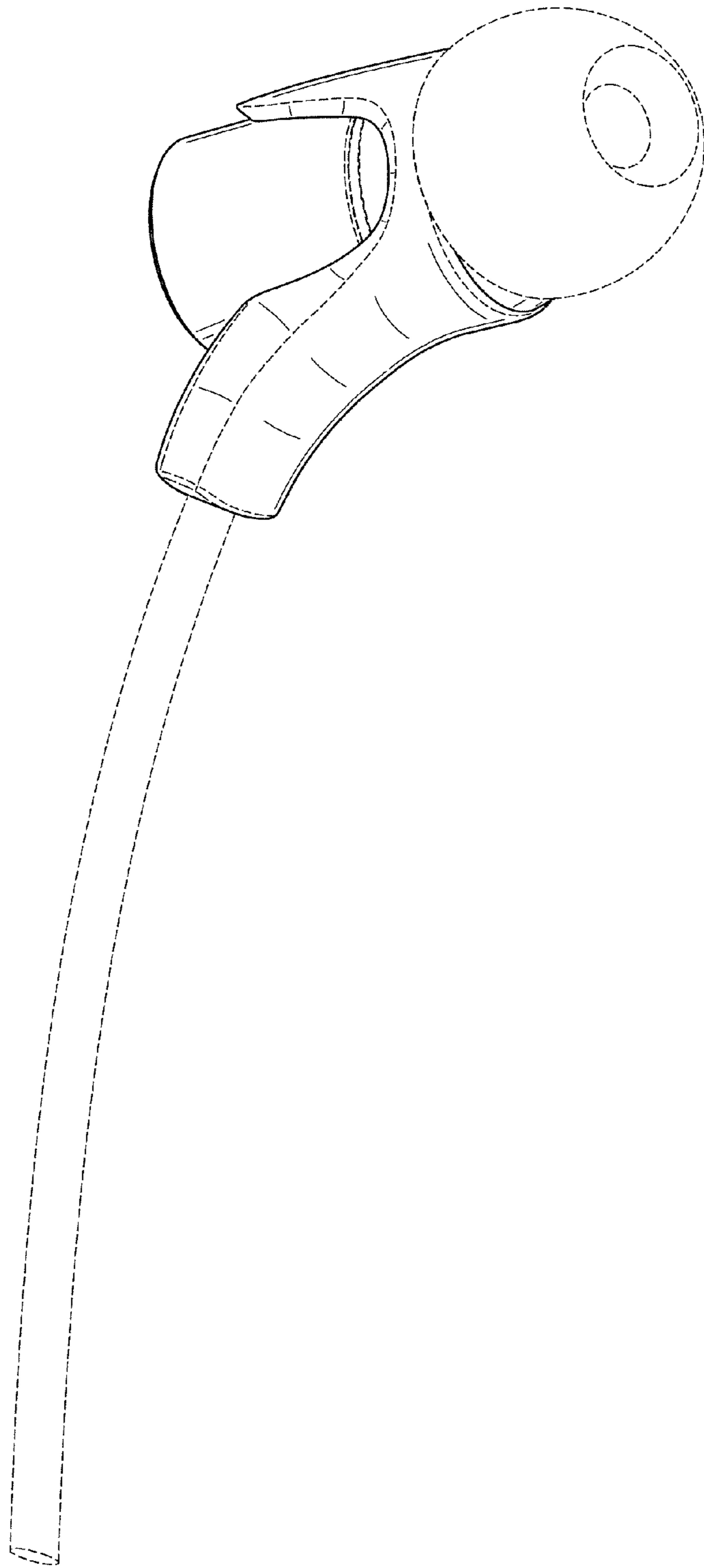

FIG. 1

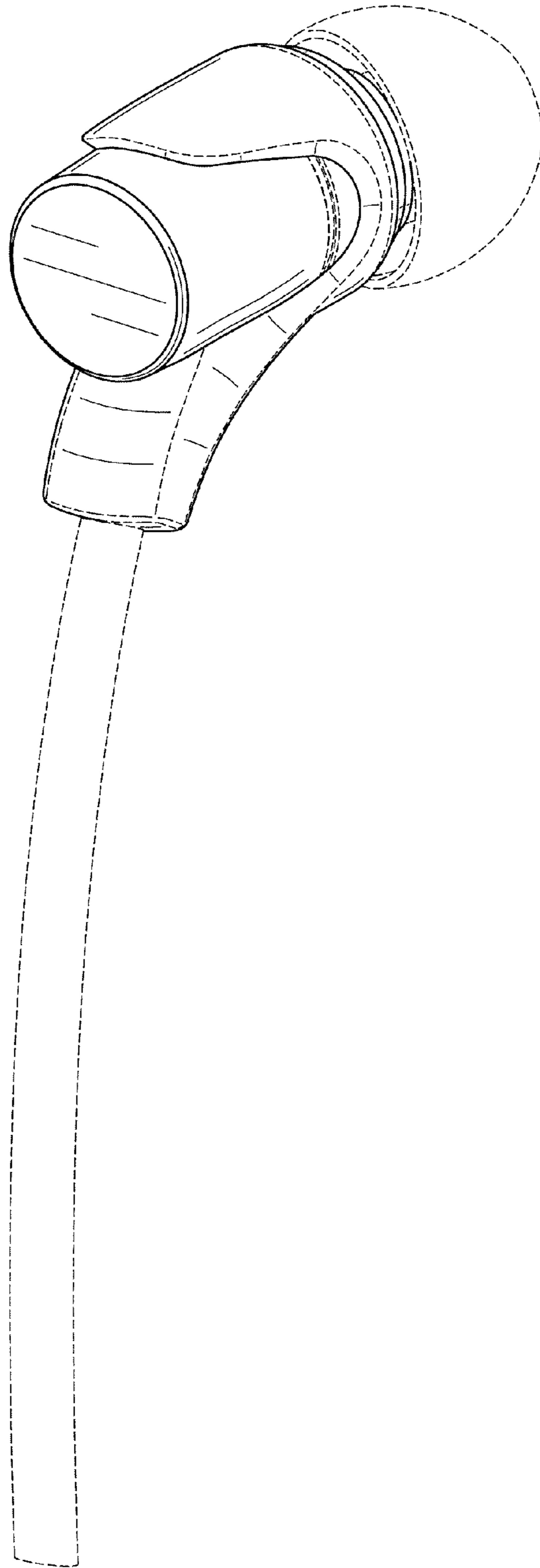

FIG. 2

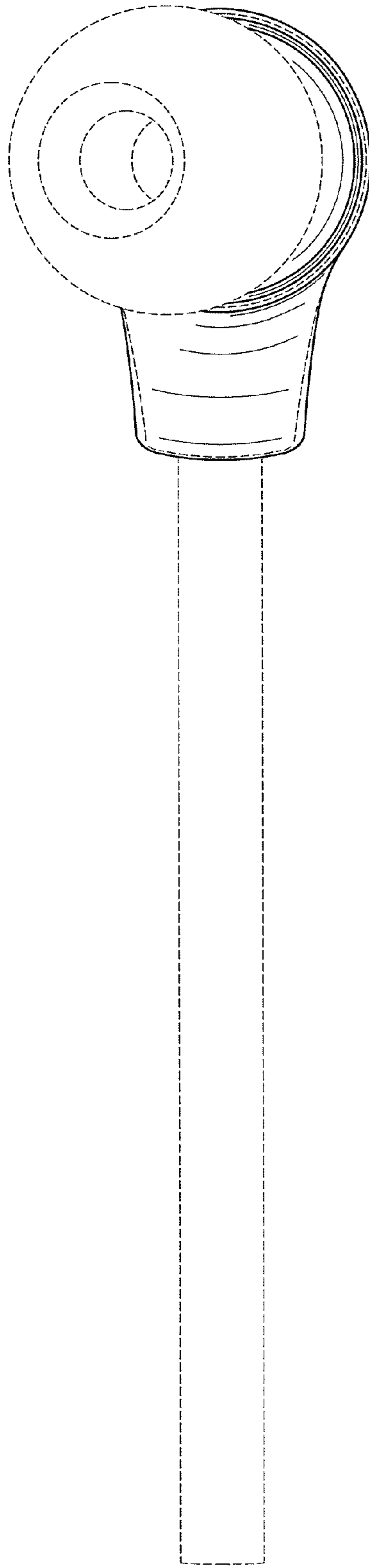

FIG. 3

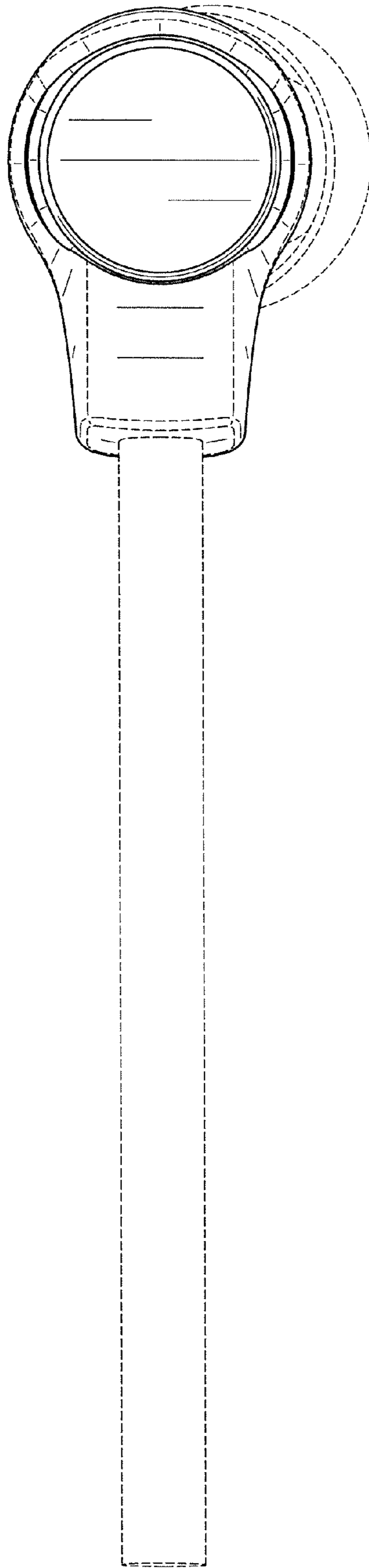

FIG. 4

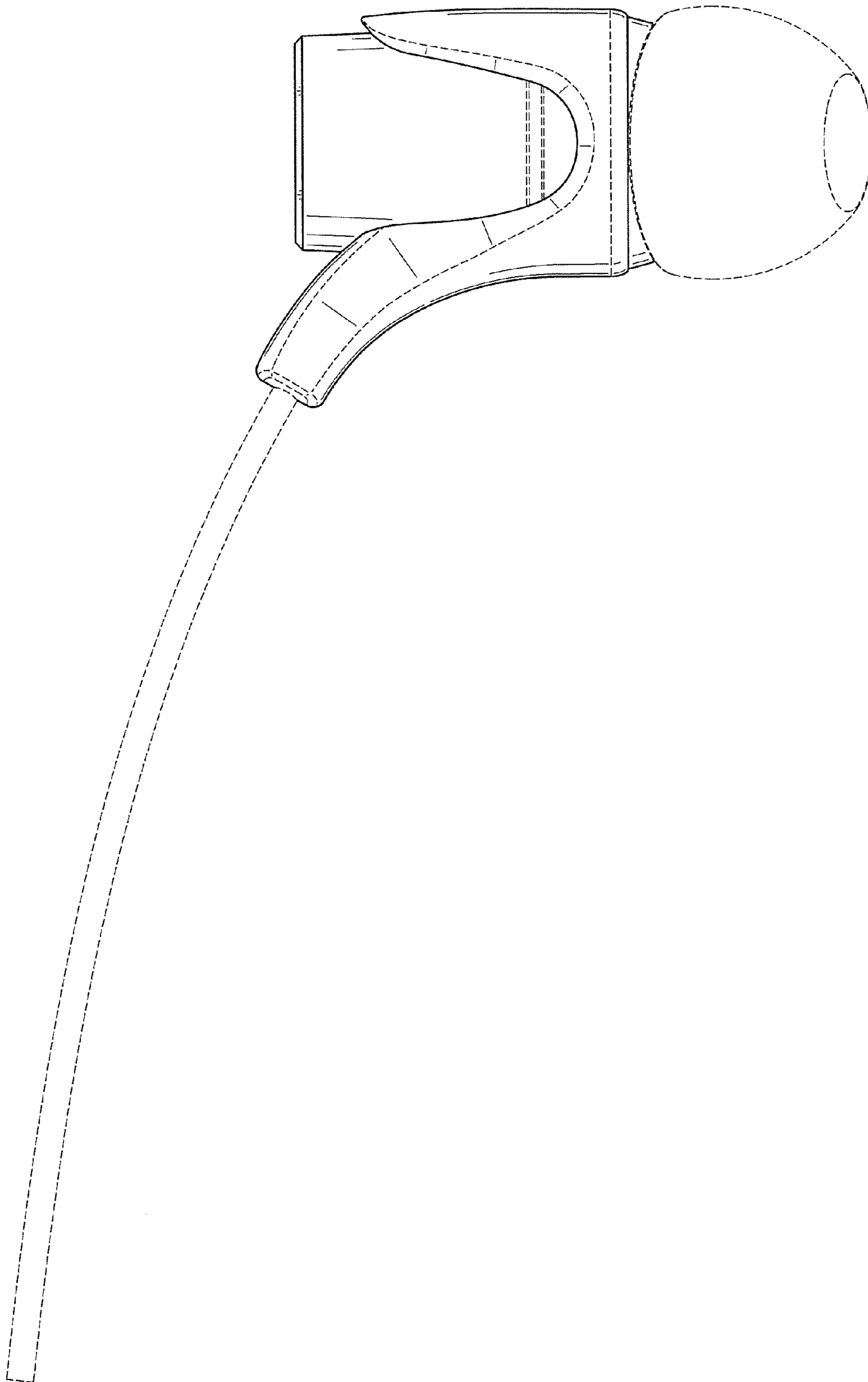

FIG. 5

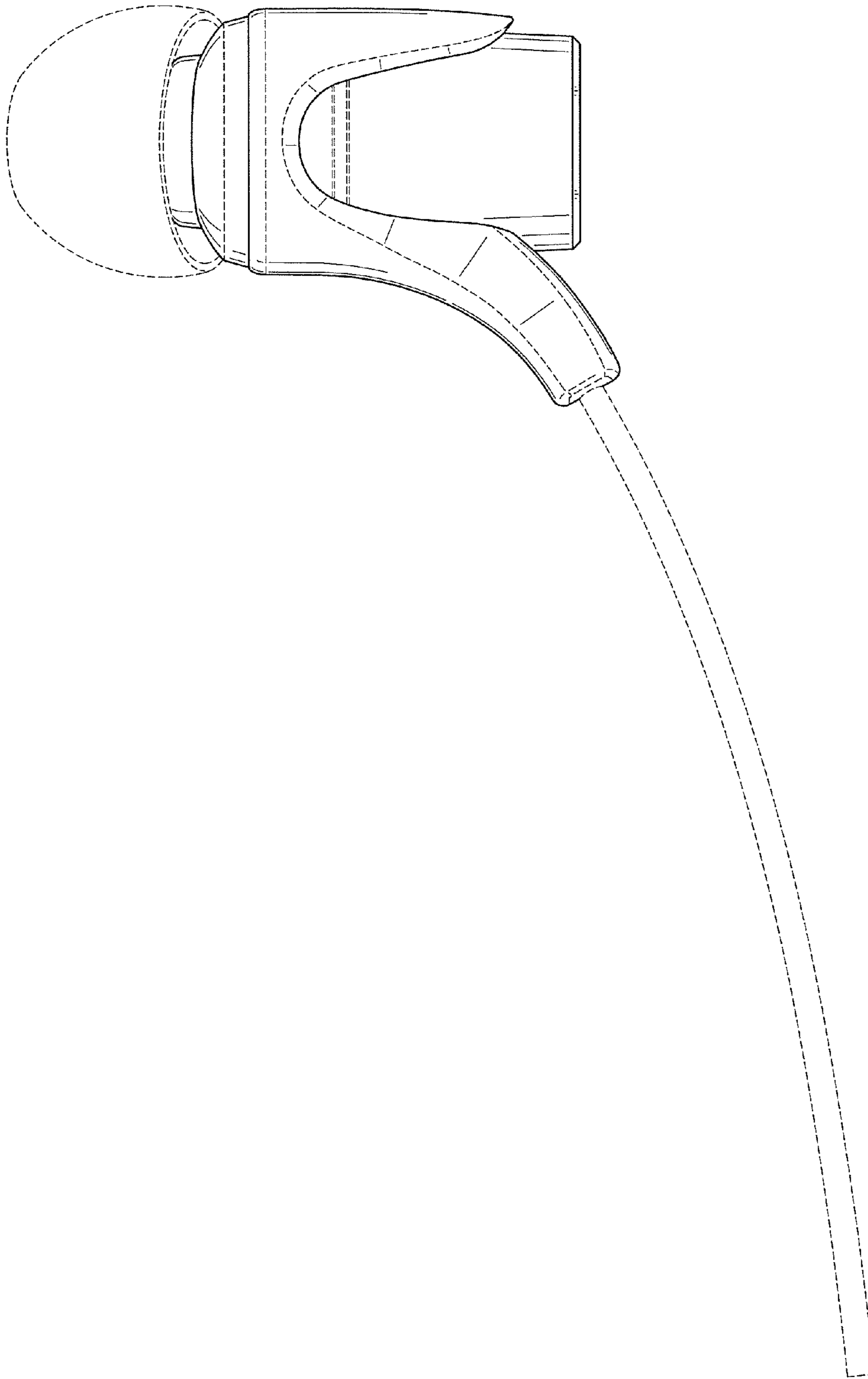

FIG. 6

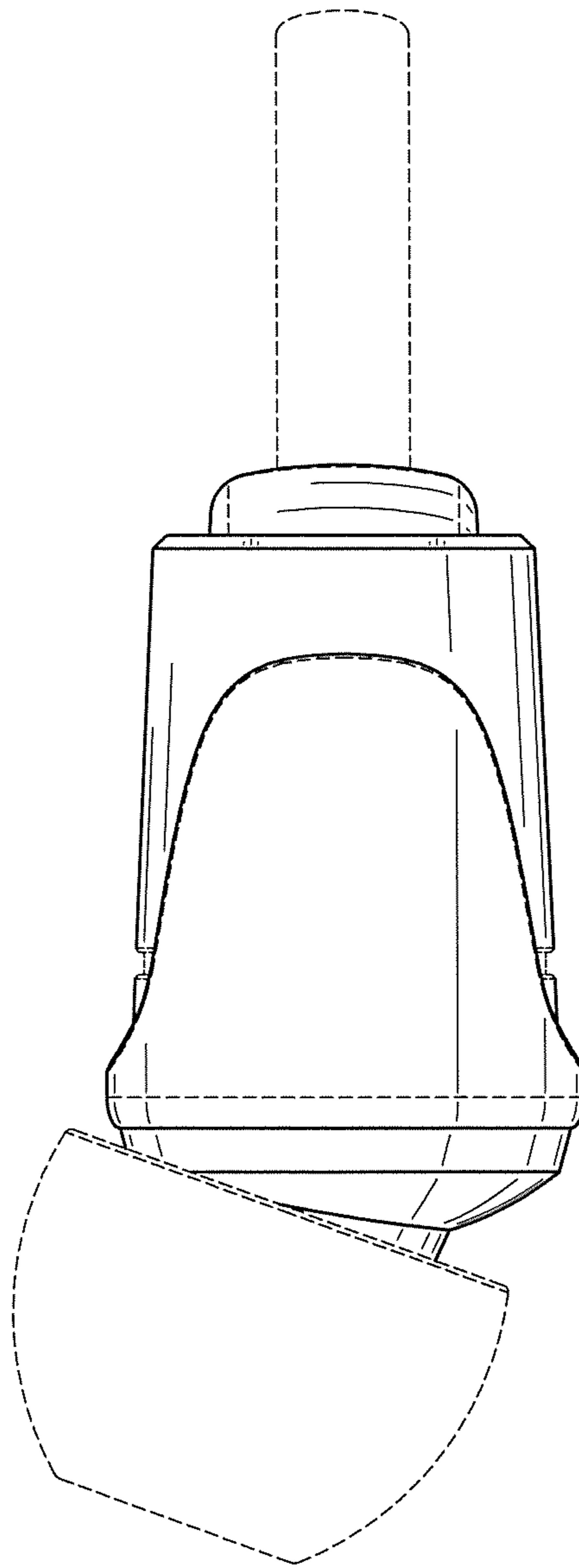

FIG. 7

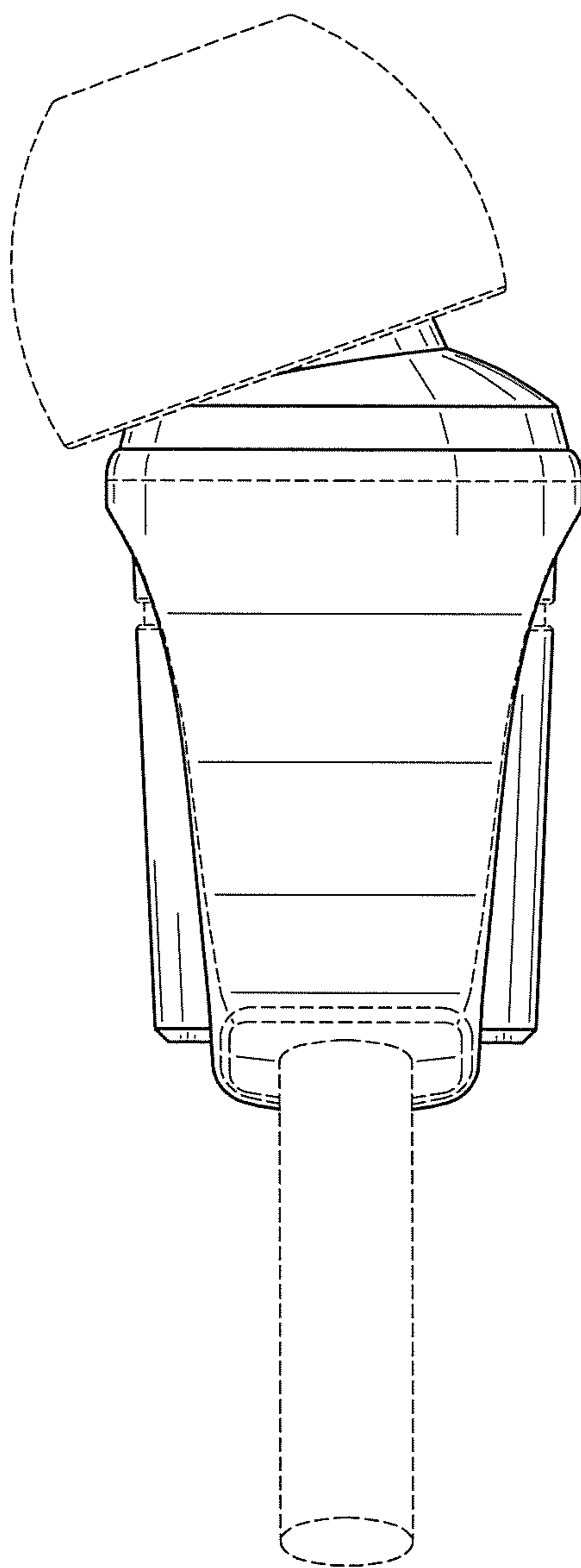

FIG. 8