



US00D702651S

(12) **United States Design Patent**
Reed et al.

(10) **Patent No.:** **US D702,651 S**
(45) **Date of Patent:** **** Apr. 15, 2014**

(54) **ELECTRICAL COMPONENT FACEPLATE**

(71) Applicant: **General Electric Company,**
Schenectady, NY (US)

(72) Inventors: **Christopher George Reed,** McKinney,
TX (US); **Khanh Quoc Nguyen,** Lucas,
TX (US)

(73) Assignee: **General Electric Company,**
Schenectady, NY (US)

(**) Term: **14 Years**

(21) Appl. No.: **29/449,755**

(22) Filed: **Mar. 15, 2013**

(51) **LOC (10) Cl.** **13-03**

(52) **U.S. Cl.**
USPC **D13/177**

(58) **Field of Classification Search**
USPC D13/162, 169, 173, 174, 177; D14/257,
D14/258, 265, 441, 445, 446, 450; 174/66,
174/67; 220/241; 312/223.2; 361/679.02,
361/679.33, 740, 798, 800, 816
See application file for complete search history.

(56) **References Cited**

U.S. PATENT DOCUMENTS

D357,461	S *	4/1995	Zaplatynsky et al.	D13/177
D411,991	S *	7/1999	Khuu	D14/442
D424,526	S *	5/2000	Yang	D13/177
6,288,902	B1 *	9/2001	Kim et al.	361/725
6,473,300	B1 *	10/2002	Youngquist et al.	361/679.33
D470,853	S *	2/2003	Macor et al.	D14/441
6,542,383	B1	4/2003	Tsuyuki et al.	
6,567,274	B1	5/2003	Tusan et al.	
6,603,657	B2 *	8/2003	Tanzer et al.	361/679.33
D486,454	S *	2/2004	Vink-Ellis et al.	D13/158
D492,319	S *	6/2004	Knetsch et al.	D14/445

6,836,406	B2 *	12/2004	Weng et al.	361/679.38
6,952,341	B2 *	10/2005	Hidaka et al.	361/679.32
6,972,960	B2 *	12/2005	Ecker et al.	361/724
6,972,961	B2	12/2005	Erskine	
7,027,309	B2 *	4/2006	Franz et al.	361/798
7,061,767	B2 *	6/2006	Schmidtke et al.	361/724
D552,045	S *	10/2007	Pratt	D13/177
7,301,778	B1 *	11/2007	Fang	361/759
7,307,836	B2 *	12/2007	Scicluna et al.	361/679.33
7,327,585	B1 *	2/2008	Fan et al.	361/816
D587,216	S *	2/2009	Peng	D13/177
7,492,607	B2	2/2009	Nguyen et al.	
7,554,811	B2 *	6/2009	Scicluna et al.	361/725
7,684,213	B2 *	3/2010	Titus	361/818
D619,108	S *	7/2010	Lin	D13/177

(Continued)

Primary Examiner — Selina Sikder

(74) *Attorney, Agent, or Firm* — Dolly Wu; General Electric Company

(57) **CLAIM**

We claim the ornamental design for an electrical component faceplate, as shown and described.

DESCRIPTION

FIG. 1 is a front perspective view of a faceplate showing our new design;
FIG. 2 is a front view of the faceplate design shown in FIG. 1;
FIG. 3 is a top view of the faceplate design shown in FIG. 1;
FIG. 4 is a bottom view of the faceplate design shown in FIG. 1;
FIG. 5 is a right view of the faceplate design shown in FIG. 1;
FIG. 6 is a left view of the faceplate design shown in FIG. 1;
and,
FIG. 7 is a back view of the faceplate design shown in FIG. 1.
In these drawings, the solid lines illustrate the claimed ornamental design, whereas the broken lines illustrate unclaimed environmental features and form no part of the claimed design.

1 Claim, 7 Drawing Sheets

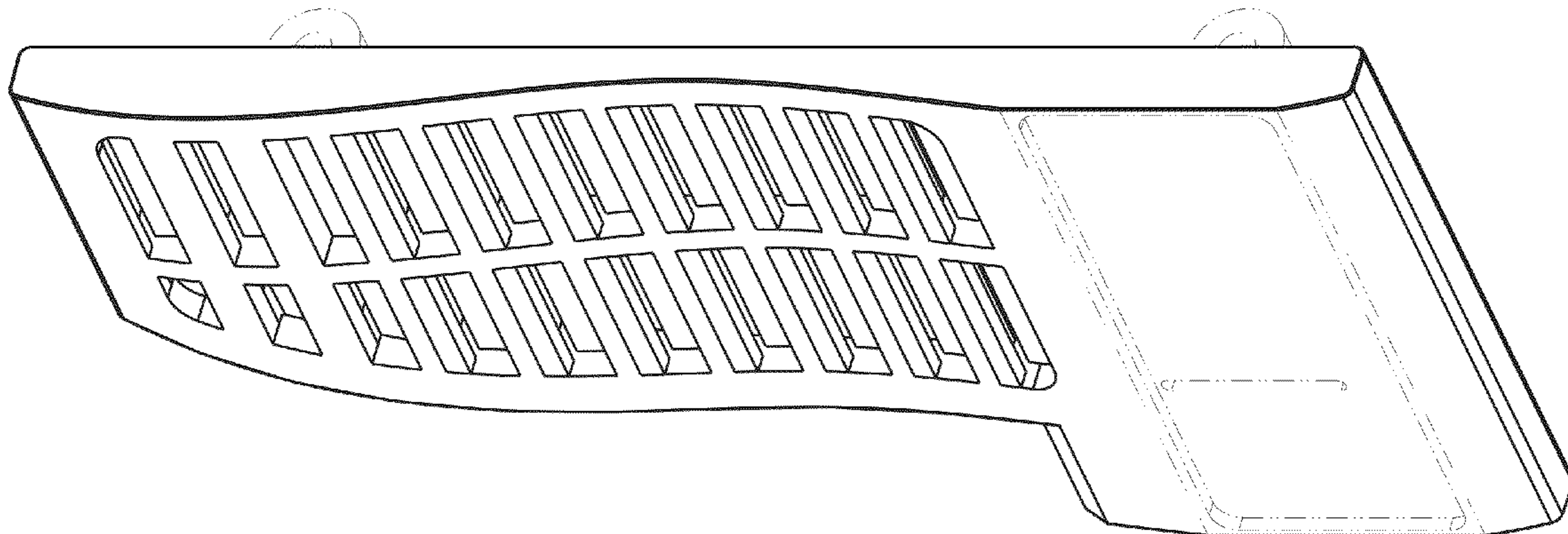

(56)

References Cited

U.S. PATENT DOCUMENTS

7,924,557 B2 *	4/2011	Li	361/679.37	8,248,775 B2 *	8/2012	Zhang et al.	361/679.33
D639,753 S *	6/2011	Saari	D13/177	D691,972 S *	10/2013	Lin	D13/177
7,974,088 B2 *	7/2011	Li	361/679.37	2004/0120122 A1 *	6/2004	Hartman et al.	361/724
8,246,129 B2 *	8/2012	Wang et al.	312/332.1	2010/0321879 A1 *	12/2010	Peng et al.	361/679.33
					2012/0134094 A1 *	5/2012	Zhang	361/679.33
					2012/0293946 A1 *	11/2012	Zheng	361/679.33

* cited by examiner

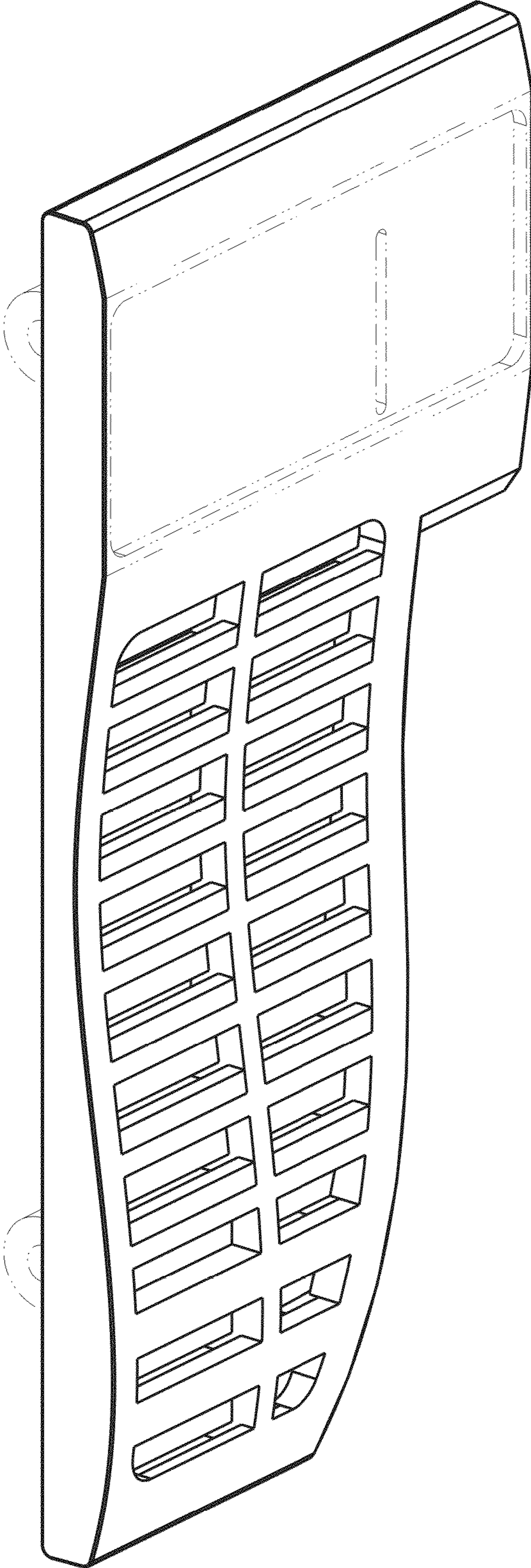

FIG 1

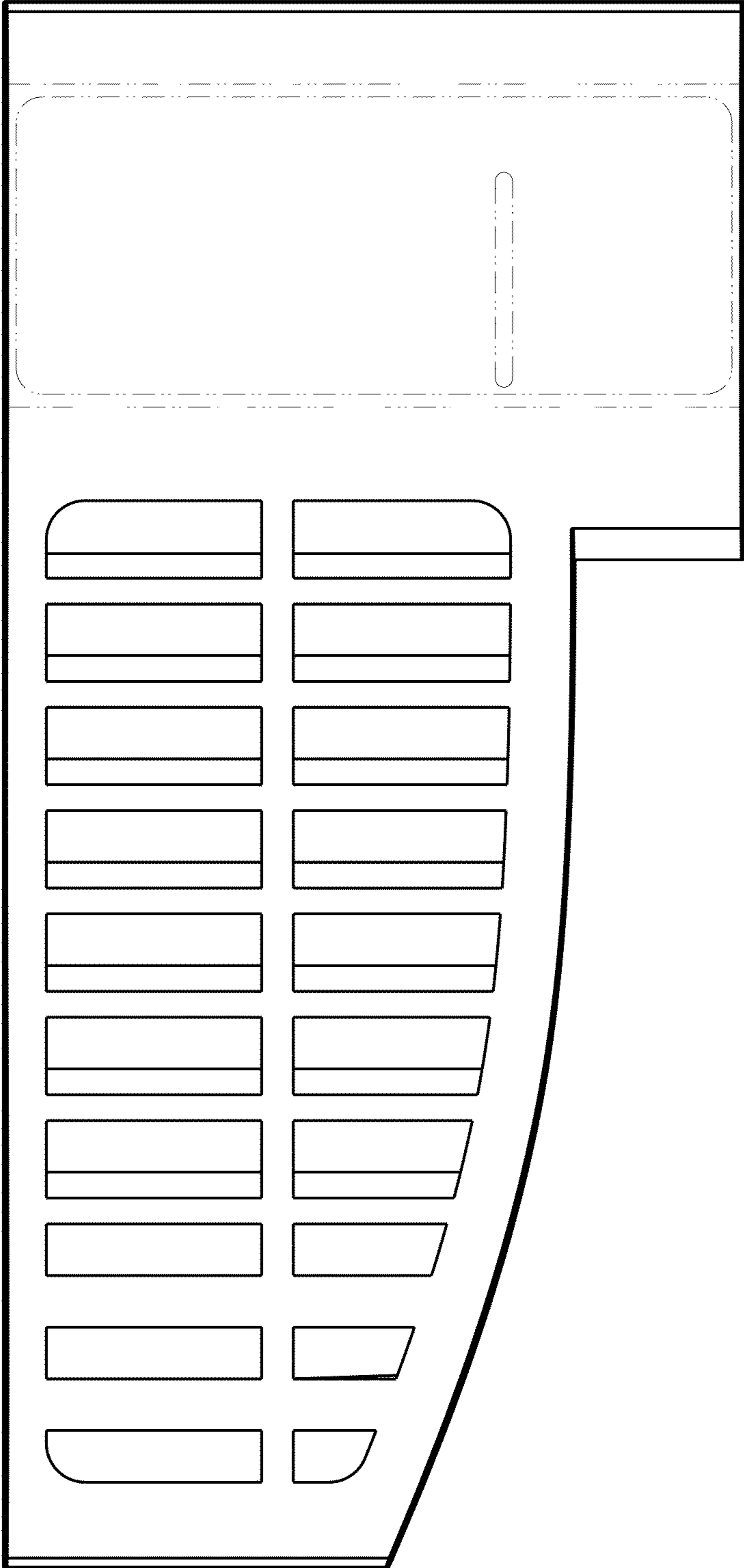

FIG 2

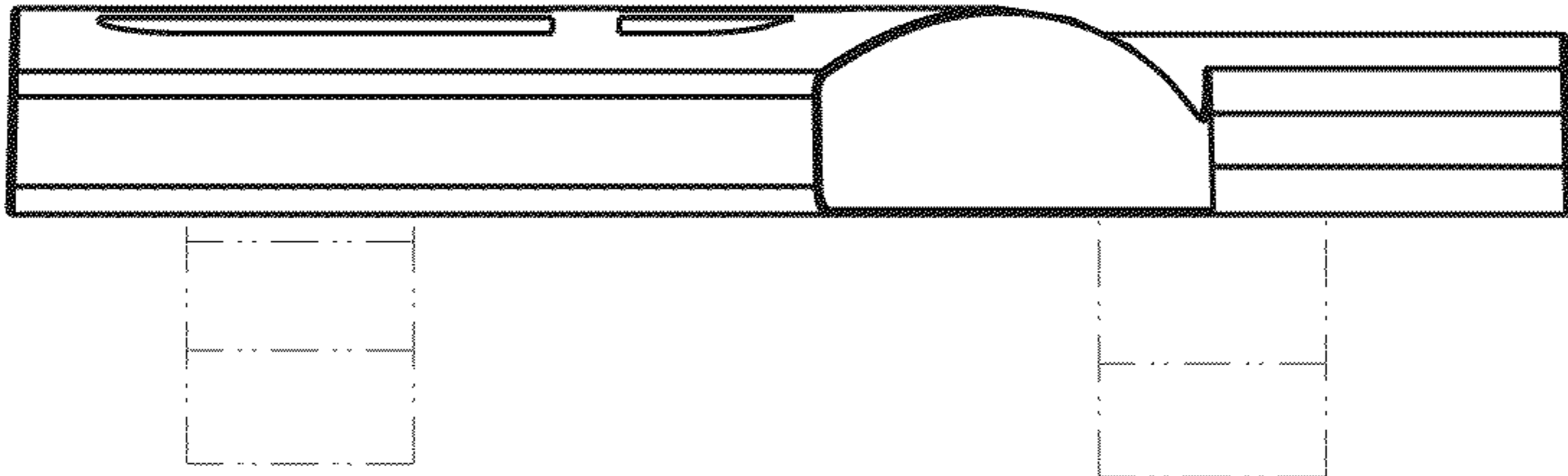

FIG 3

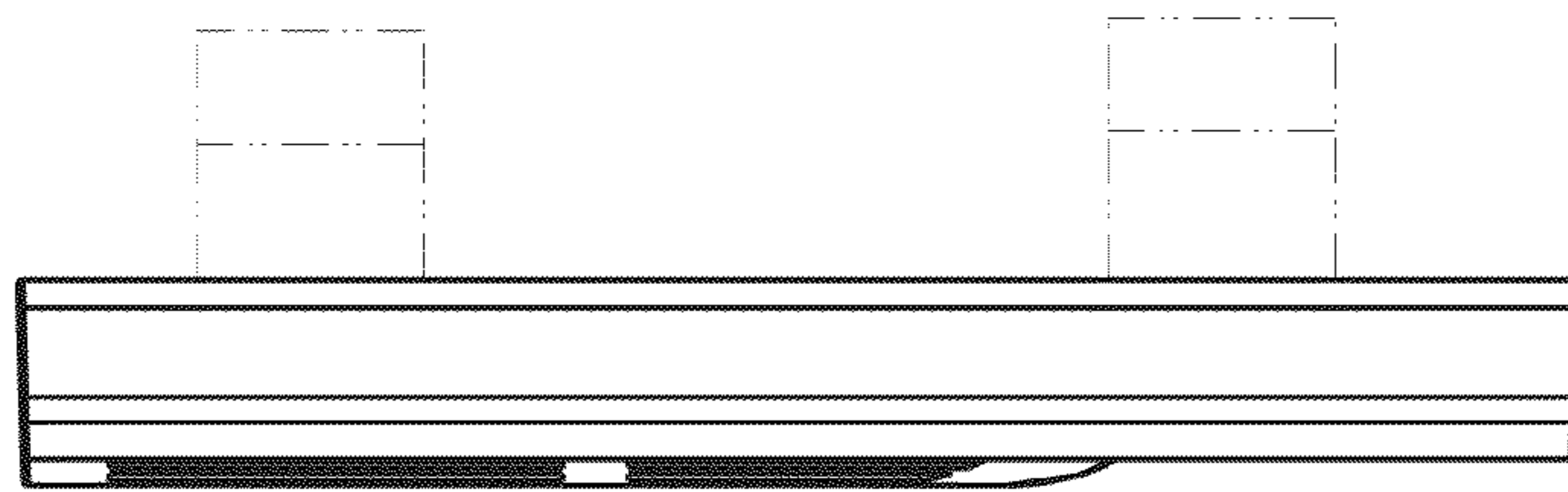

FIG 4

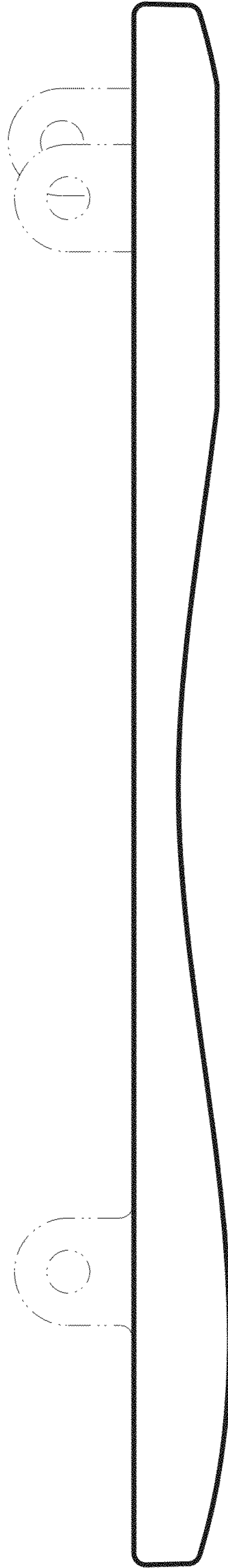

FIG 5

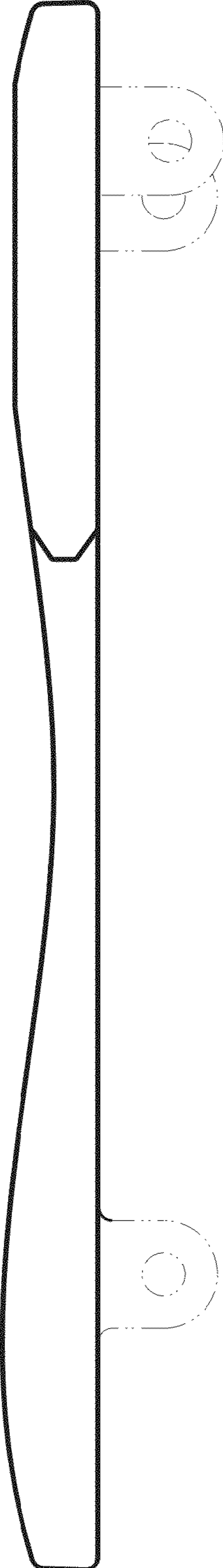

FIG 6

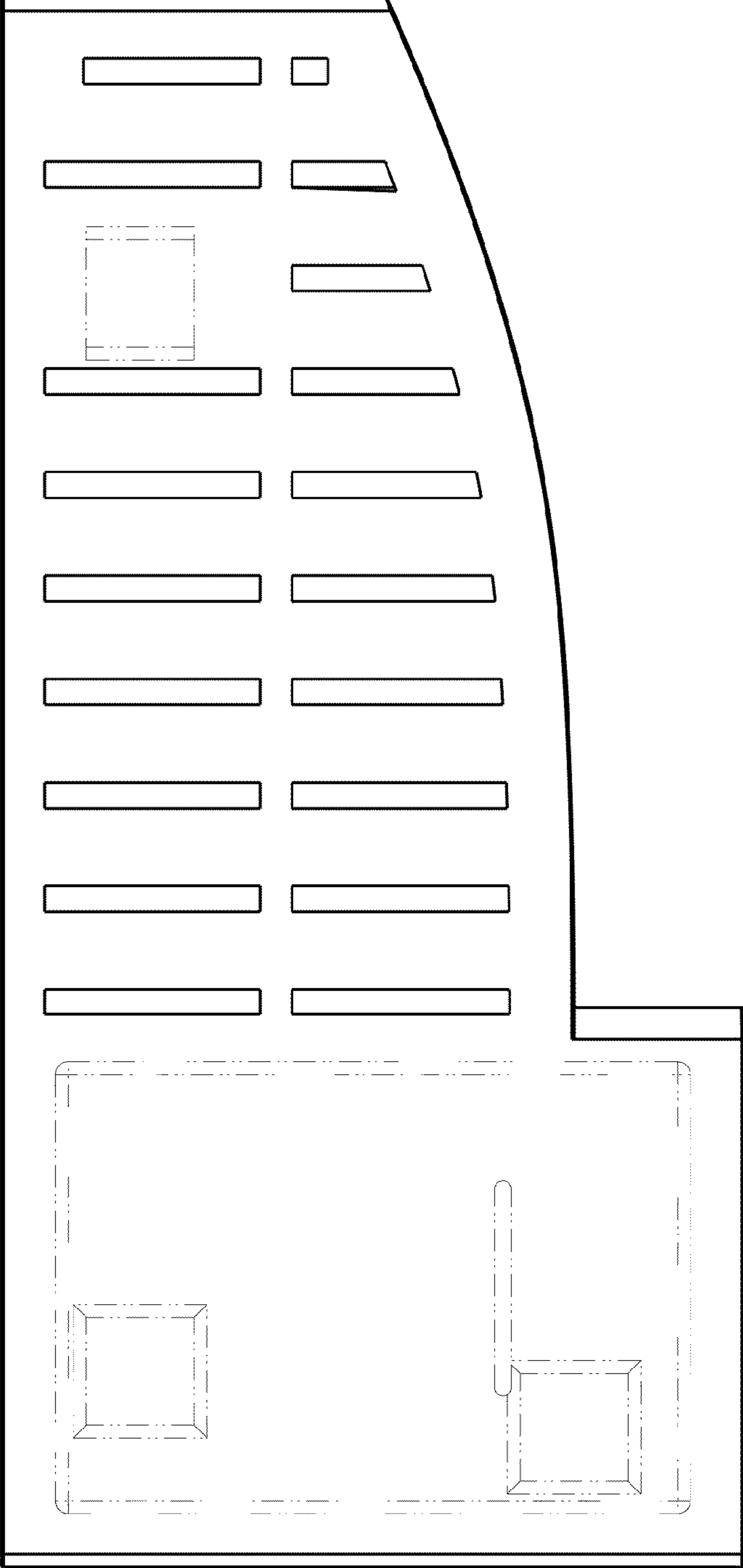

FIG 7