



US00D702634S

(12) **United States Design Patent**
Palatini

(10) **Patent No.:** **US D702,634 S**
(45) **Date of Patent:** **** Apr. 15, 2014**

(54) **WATERCOOLED TANKLESS LOADBANK**

(71) Applicant: **Experium Technologies, LLC**, Owings, MD (US)

(72) Inventor: **Lance Palatini**, Morris Plains, NJ (US)

(73) Assignee: **Experium Technologies, LLC**, Owings, MD (US)

(**) Term: **14 Years**

(21) Appl. No.: **29/434,582**

(22) Filed: **Oct. 15, 2012**

(51) **LOC (10) Cl.** **13-02**

(52) **U.S. Cl.**
USPC **D13/110**

(58) **Field of Classification Search**
USPC D13/110, 101, 123, 184, 199;
307/150-152; 361/600, 601, 622, 702,
361/703, 730, 796, 809; 363/141, 142;
712/1, 200, 201, 202, 203
See application file for complete search history.

(56) **References Cited**

U.S. PATENT DOCUMENTS

D298,616 S * 11/1988 Aschbacher et al. D13/110
D379,963 S * 6/1997 Ikeda et al. D13/110
6,680,445 B1 * 1/2004 Oravetz et al. 200/50.33

D492,650 S * 7/2004 Nishi D13/110
D509,184 S * 9/2005 Schuttler et al. D13/110
D511,137 S * 11/2005 Tuomola et al. D13/110
D512,696 S * 12/2005 Nurmi et al. D13/184

* cited by examiner

Primary Examiner — Derrick Holland

(74) *Attorney, Agent, or Firm* — Laubscher & Laubscher, P.C.

(57) **CLAIM**

The ornamental design for a water cooled tankless loadbank, as shown and described.

DESCRIPTION

FIG. 1 is a front perspective view of a water cooled tankless loadbank showing my new design;
FIG. 2 is a rear perspective view thereof;
FIG. 3 is a right side elevation view thereof;
FIG. 4 is a front elevation view thereof;
FIG. 5 is a left side elevation view thereof;
FIG. 6 is a rear elevation view thereof;
FIG. 7 is a top plan view thereof;
FIG. 8 is a bottom plan view thereof; and,
FIG. 9 is a rear perspective view of an alternate embodiment thereof.

The broken lines shown represent unclaimed subject matter and form no part of the claimed design.

1 Claim, 8 Drawing Sheets

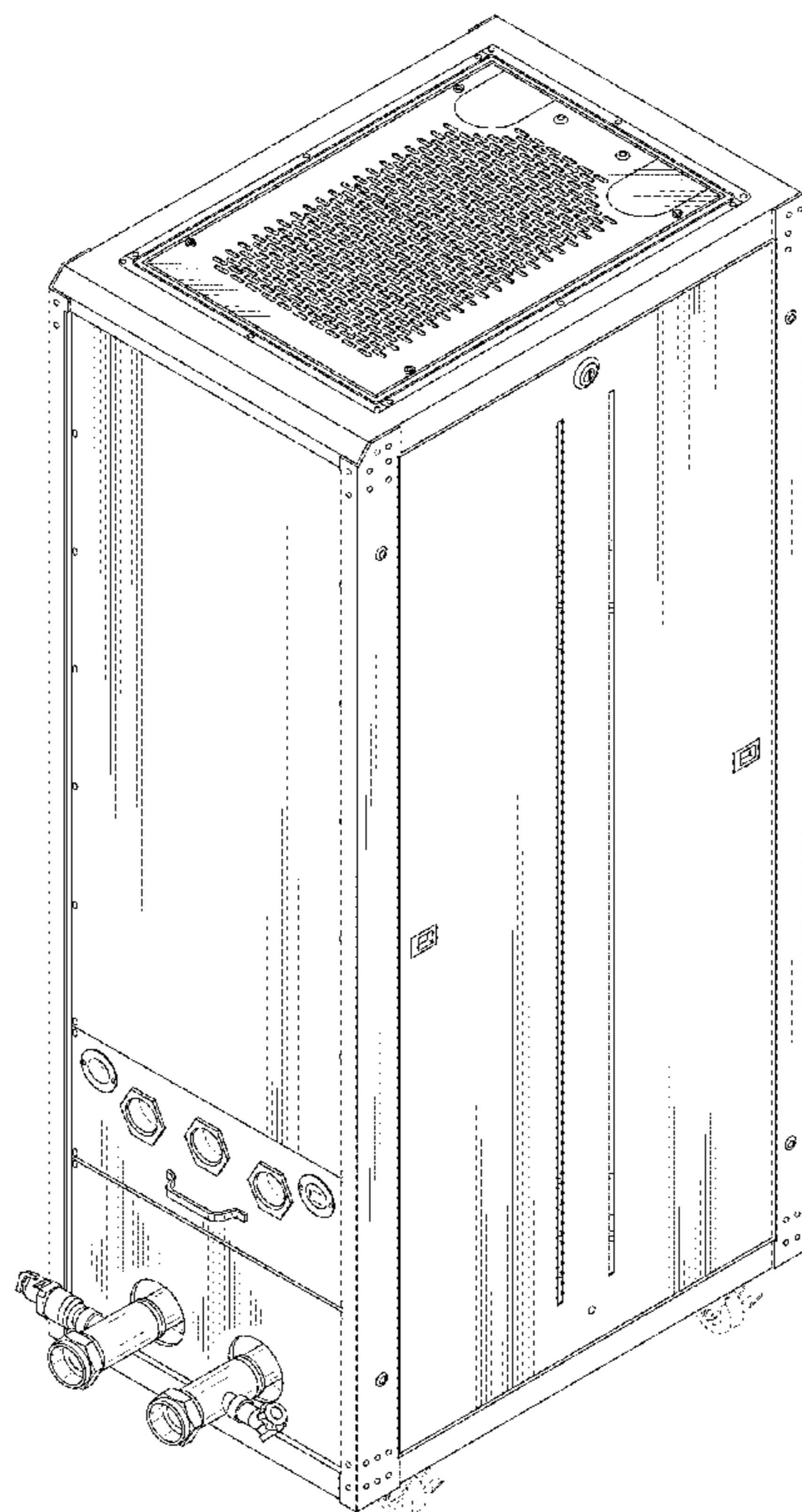

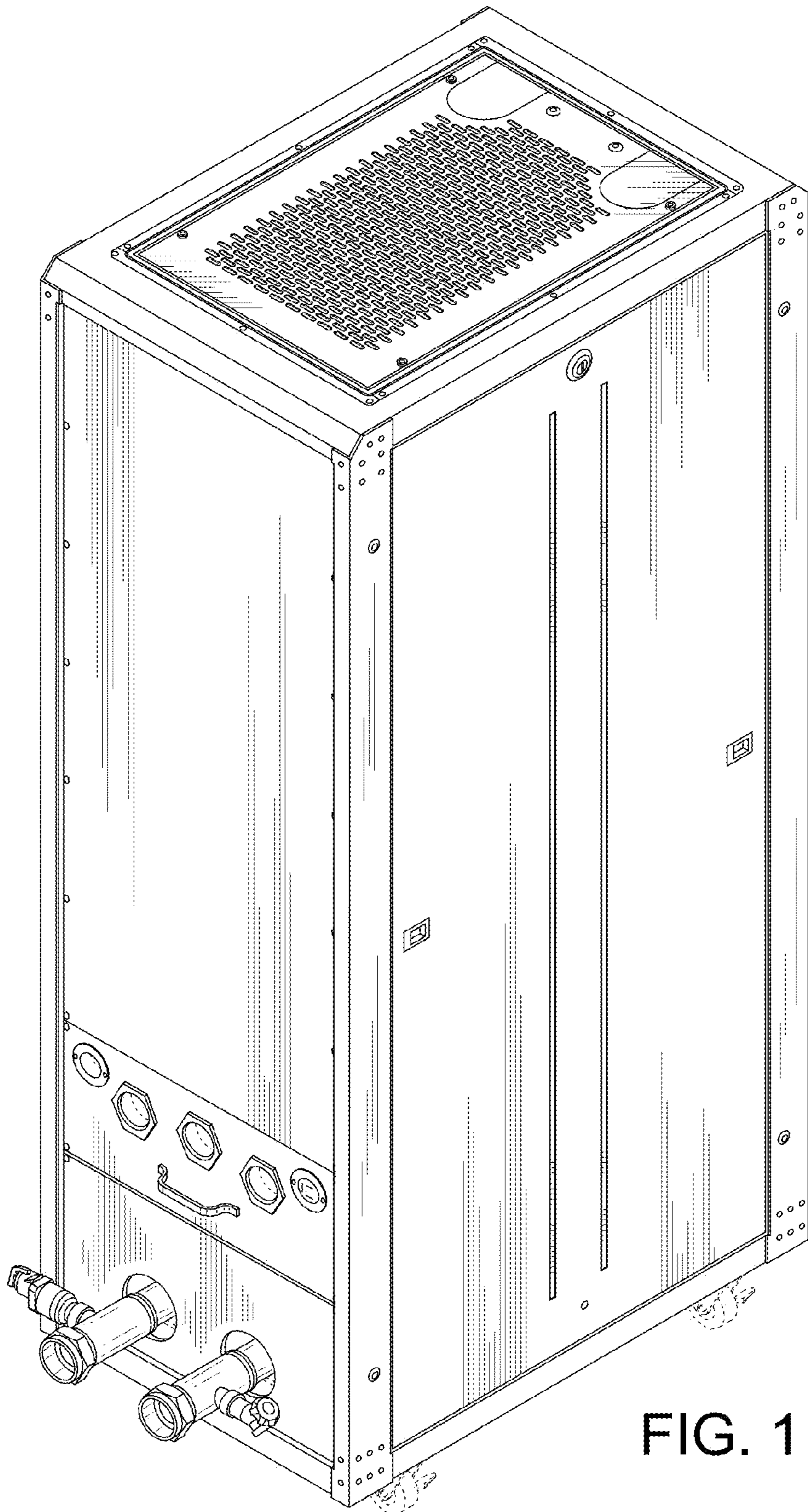

FIG. 1

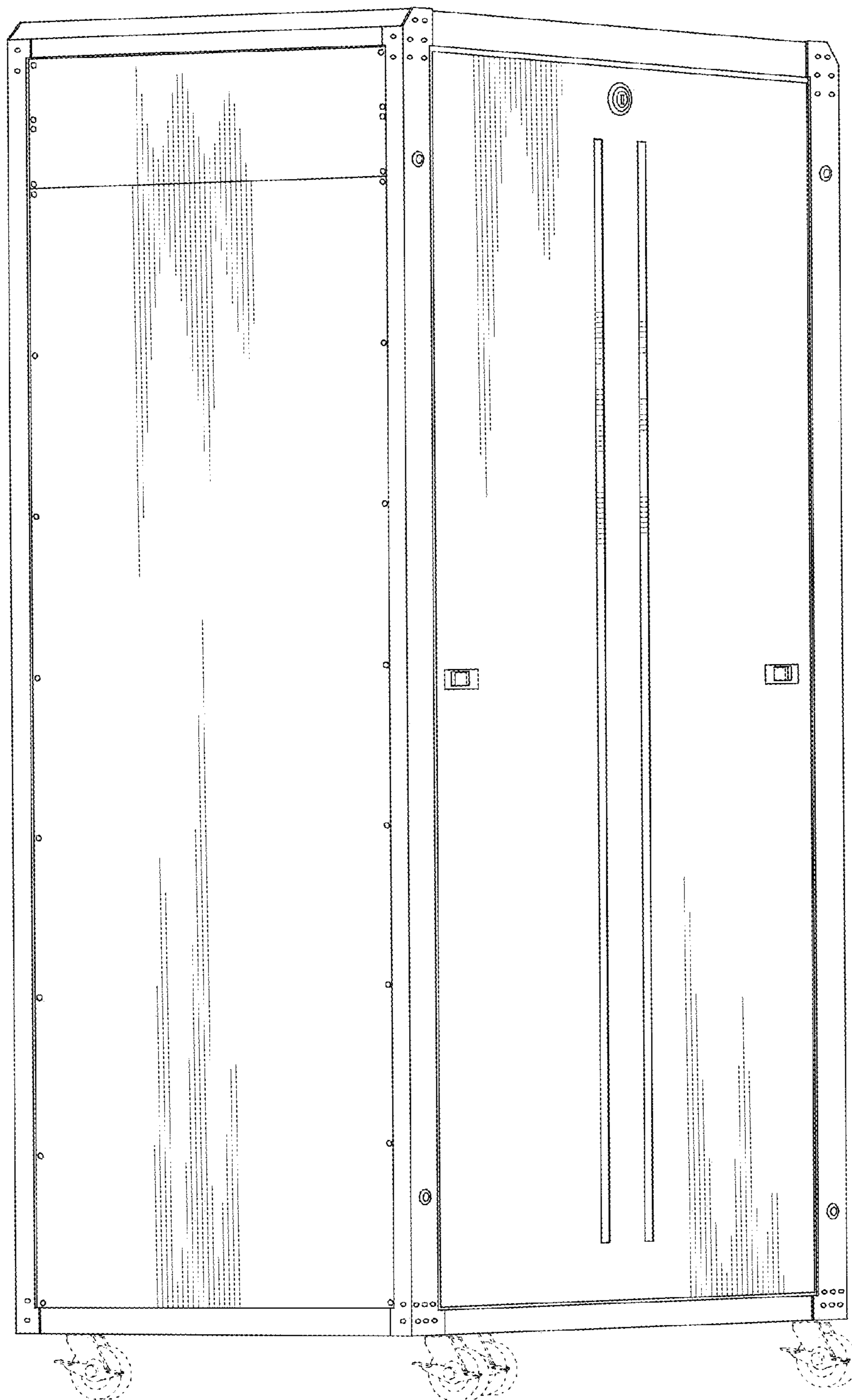

FIG. 2

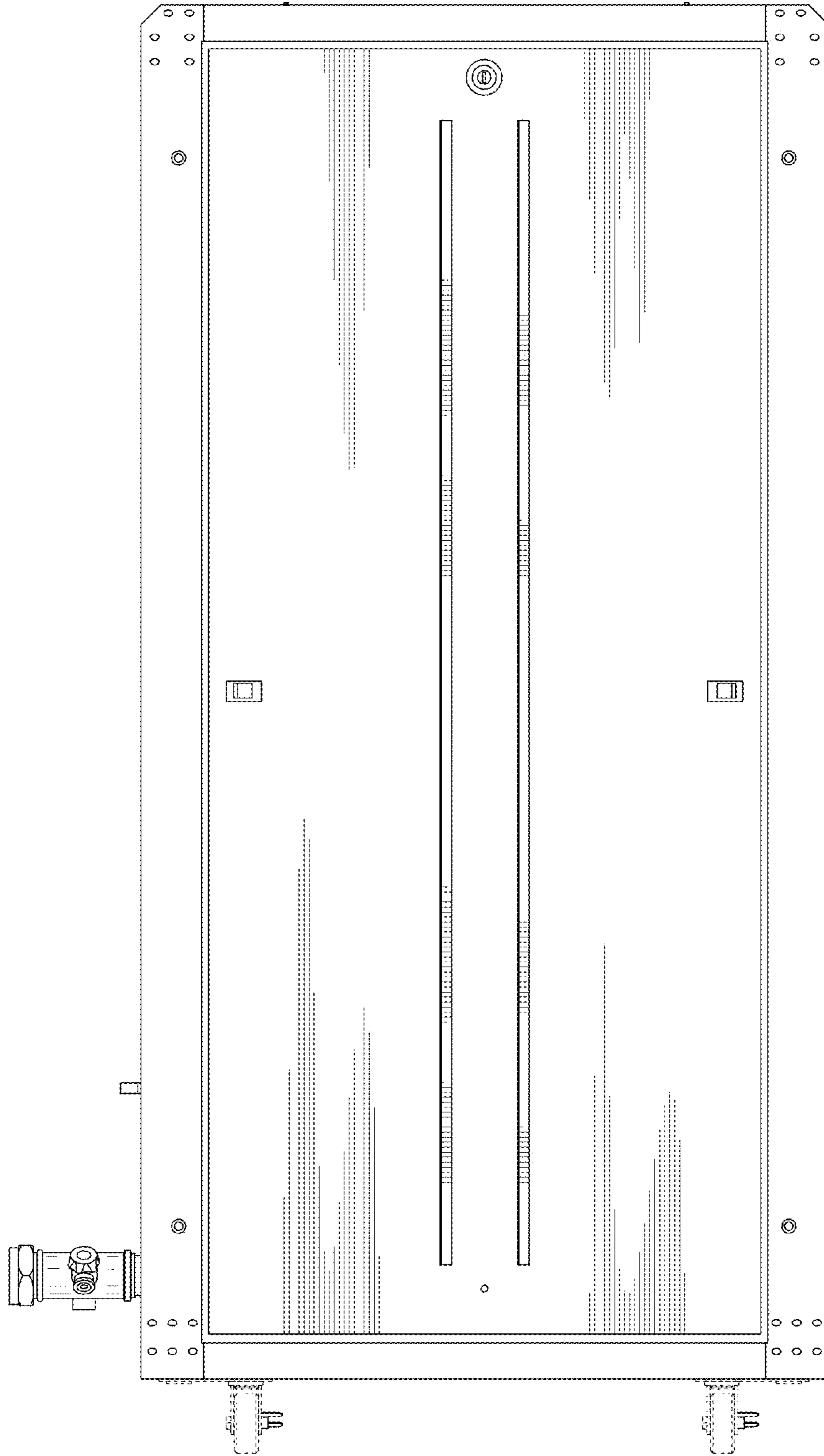

FIG. 3

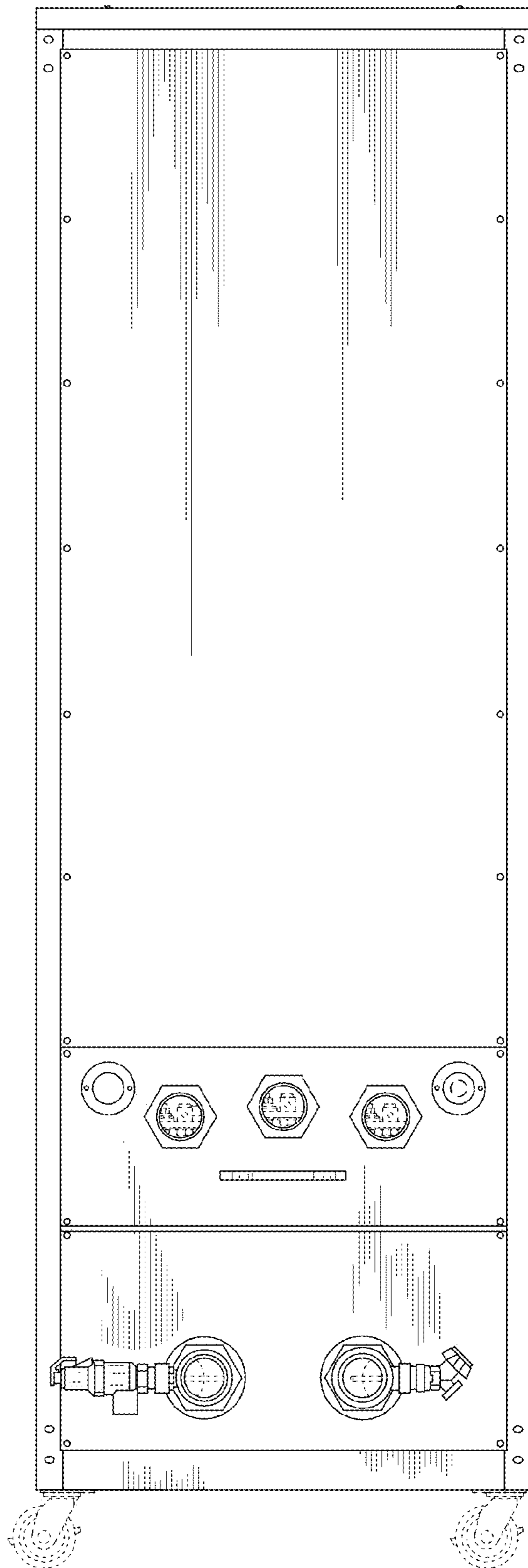

FIG. 4

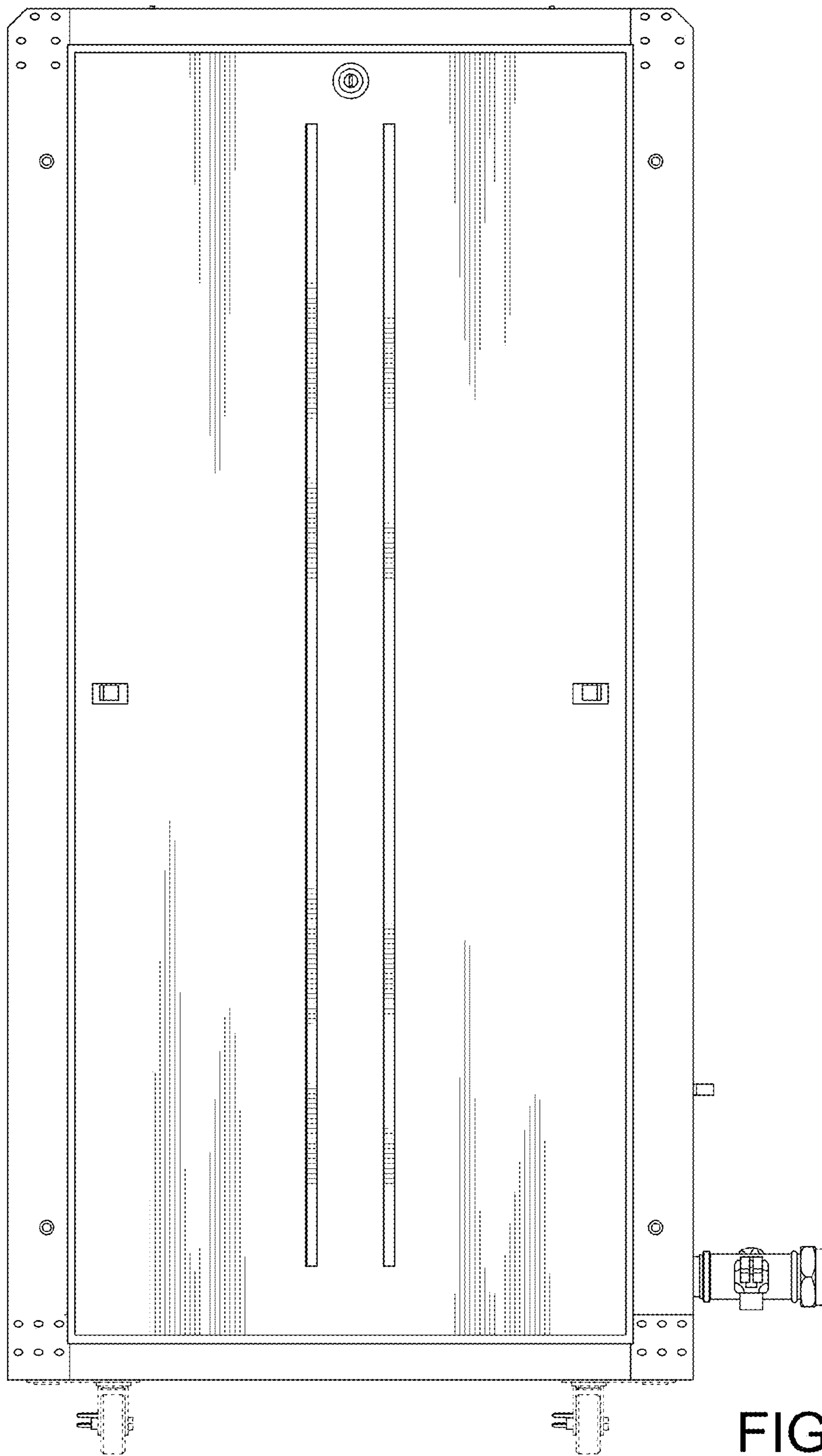

FIG. 5

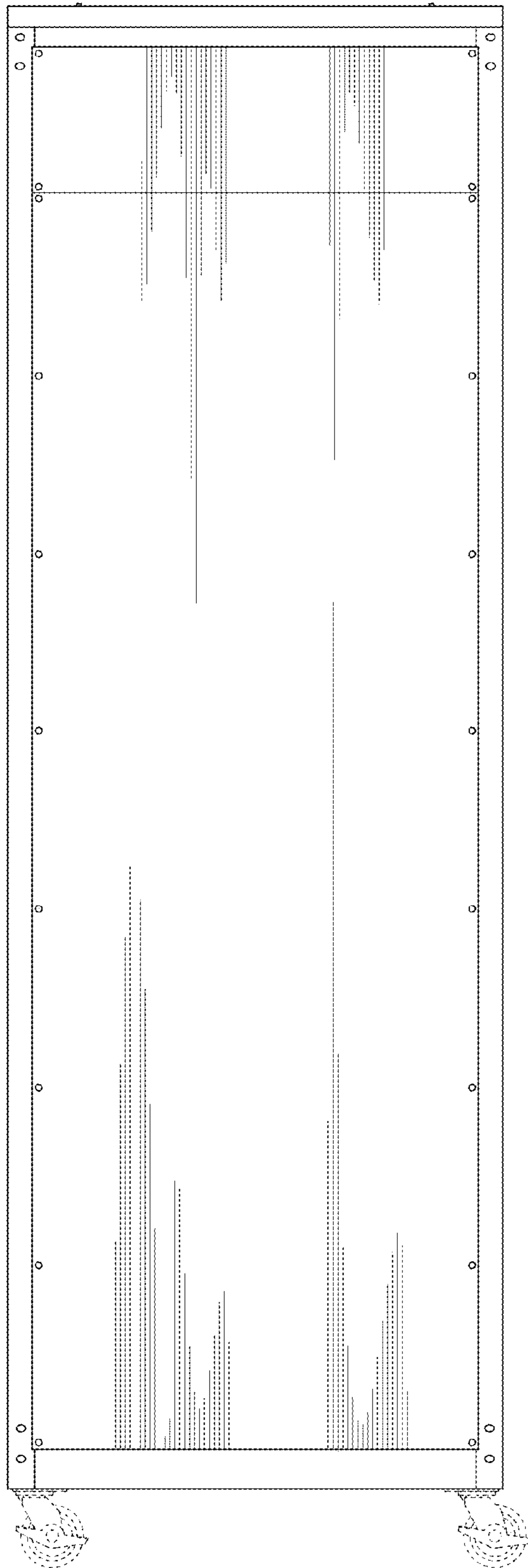

FIG. 6

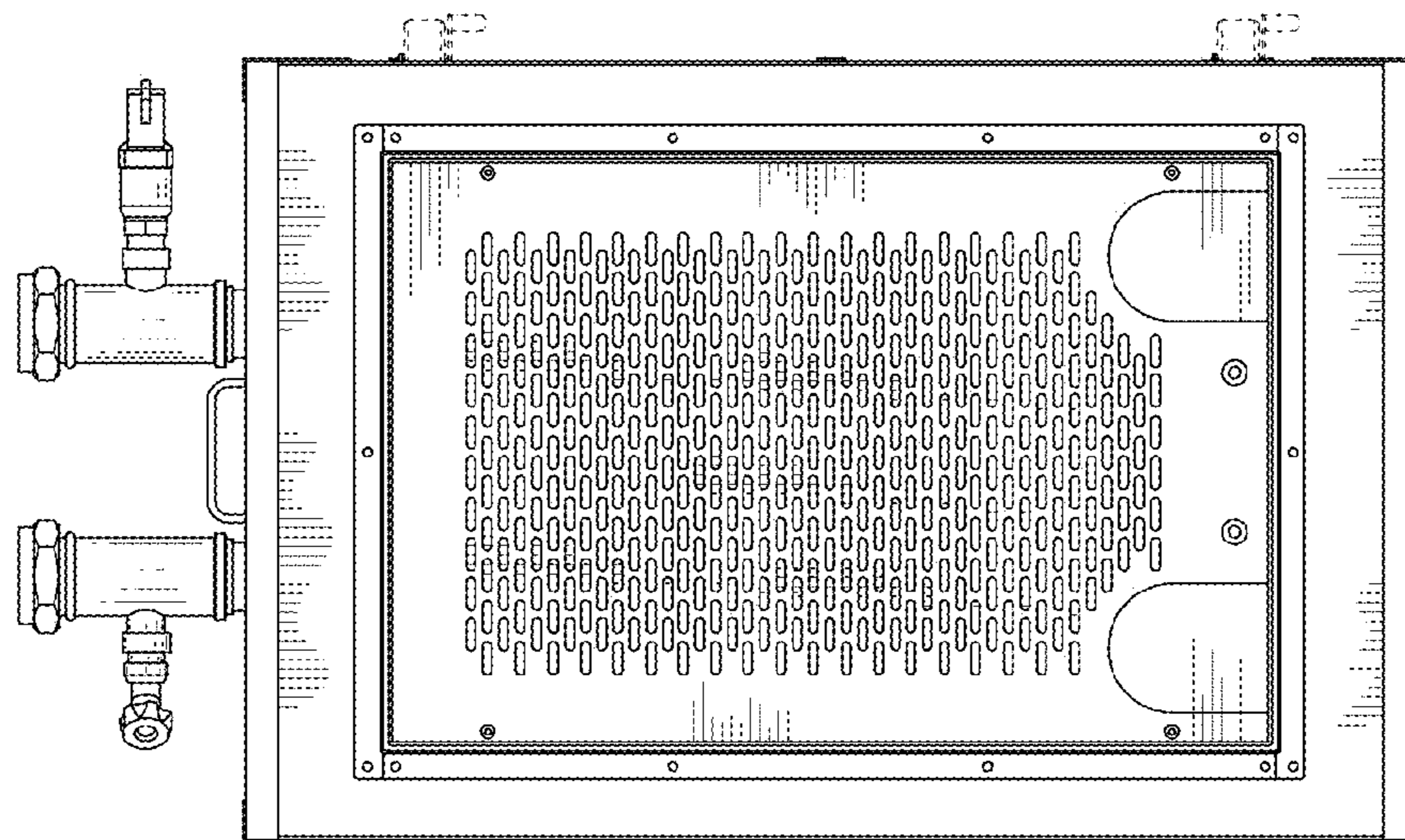

FIG. 7

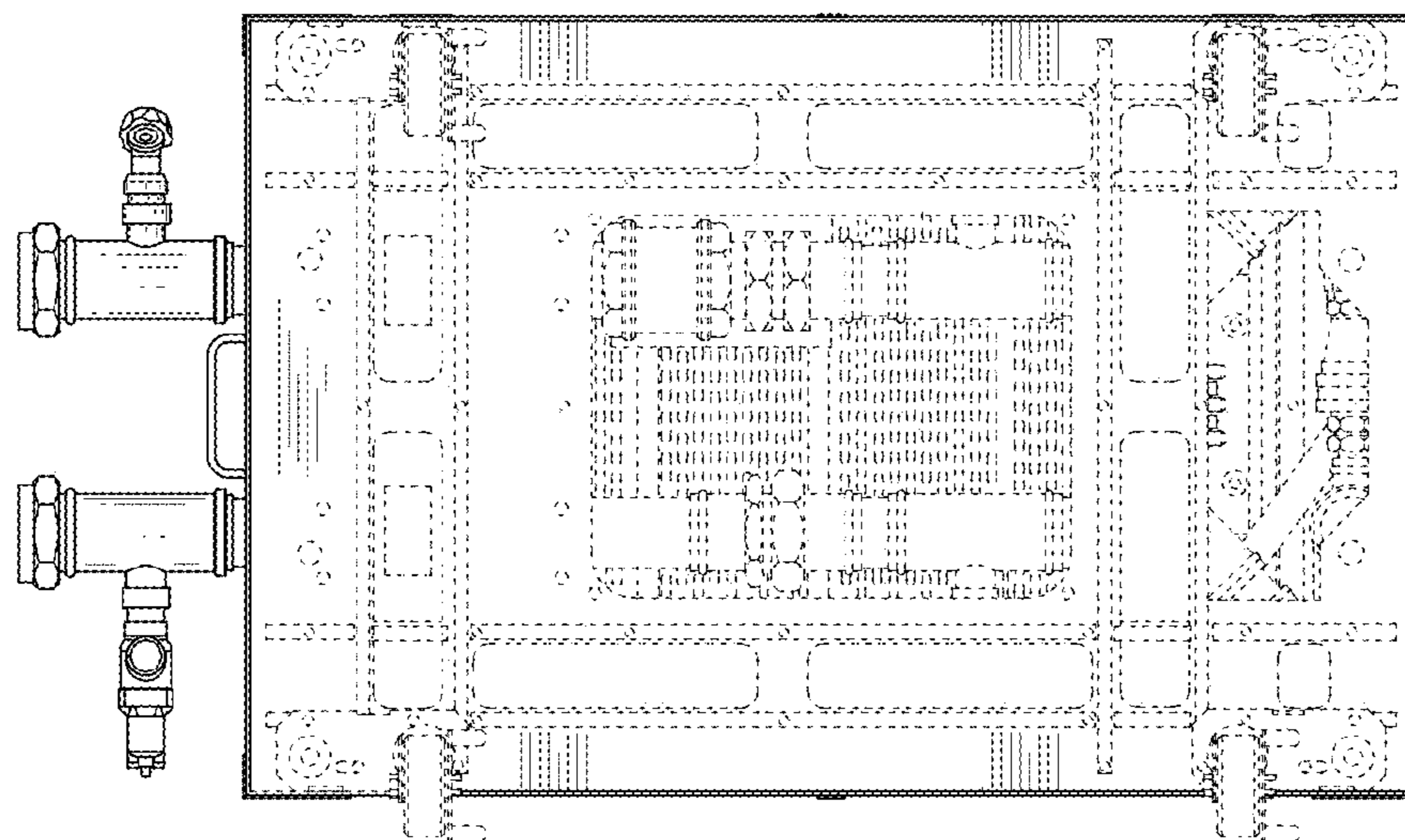

FIG. 8

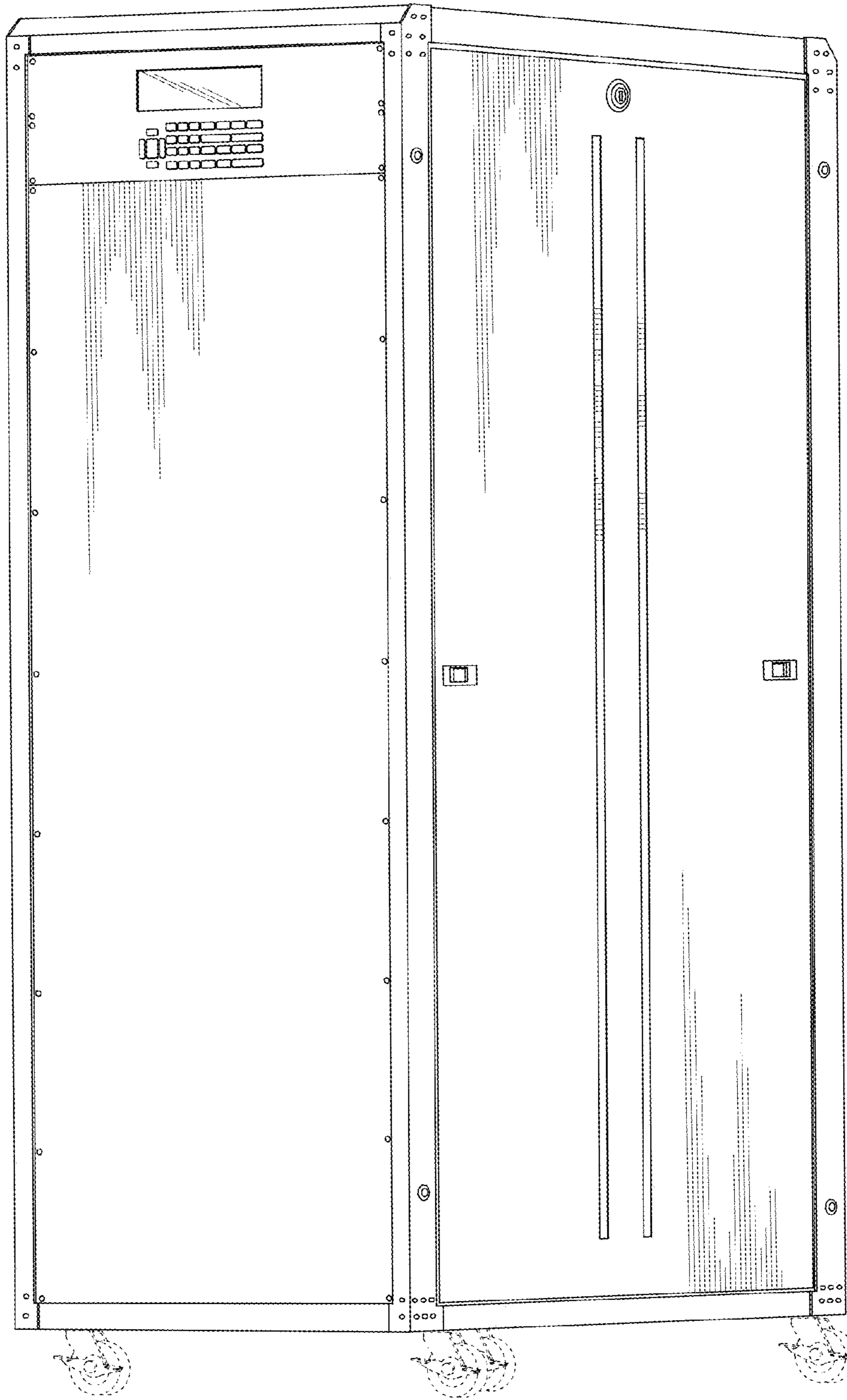

FIG. 9