



US00D702555S

(12) **United States Design Patent**
Park

(10) **Patent No.:** **US D702,555 S**

(45) **Date of Patent:** **** Apr. 15, 2014**

(54) **COSMETIC CONTAINER**

(71) Applicant: **Amorepacific Corporation**, Seoul (KR)

(72) Inventor: **Kyung Mi Park**, Seoul (KR)

(73) Assignee: **Amorepacific Corporation**, Seoul (KR)

(**) Term: **14 Years**

(21) Appl. No.: **29/462,150**

(22) Filed: **Jul. 31, 2013**

(30) **Foreign Application Priority Data**

Feb. 1, 2013 (KR) 30-2013-0005707

(51) **LOC (10) Cl.** **09-01**

(52) **U.S. Cl.**
USPC **D9/504; D9/454**

(58) **Field of Classification Search**
USPC D9/435, 454, 500, 502-505, 516, 529,
D9/549, 552, 558, 571, 682, 686-692;
D3/203.2, 203.3, 205, 302; D28/73,
D28/76-78, 81-82; 215/379, 381; 220/660,
220/662, 665, 675
See application file for complete search history.

(56) **References Cited**

U.S. PATENT DOCUMENTS

D391,162 S *	2/1998	Kokenge	D9/504
D411,747 S *	6/1999	Kokenge et al.	D9/503
D424,943 S *	5/2000	Kokenge et al.	D9/504
D522,695 S *	6/2006	Desdoigts	D28/82
D561,943 S *	2/2008	Desdoigts	D28/82
D615,868 S *	5/2010	Rodriguez et al.	D9/529

D640,925 S *	7/2011	Rodriguez et al.	D9/529
D641,245 S *	7/2011	Rodriguez et al.	D9/529
D645,749 S *	9/2011	Lee	D9/504
D645,750 S *	9/2011	Lee	D9/504
D662,822 S *	7/2012	Morais et al.	D9/504
D688,138 S *	8/2013	Kim	D9/690
D692,773 S *	11/2013	Kim	D9/690

* cited by examiner

Primary Examiner — Ian Simmons

Assistant Examiner — Dana L Meyrow

(74) *Attorney, Agent, or Firm* — Ohlandt Greeley Ruggiero & Perle L.L.P.

(57) **CLAIM**

The ornamental design for a cosmetic container, as shown and described.

DESCRIPTION

FIG. 1 is a top, perspective view of the cosmetic container of the present disclosure;
 FIG. 2 is a front elevation view of the cosmetic container shown in FIG. 1;
 FIG. 3 is a rear elevation view of the cosmetic container shown in FIG. 1;
 FIG. 4 is a left side elevation view of the cosmetic container shown in FIG. 1;
 FIG. 5 is a right side elevation view of the cosmetic container shown in FIG. 1;
 FIG. 6 is a top plan view of the cosmetic container shown in FIG. 1; and,
 FIG. 7 is a bottom plan view of the cosmetic container shown in FIG. 1.

1 Claim, 7 Drawing Sheets

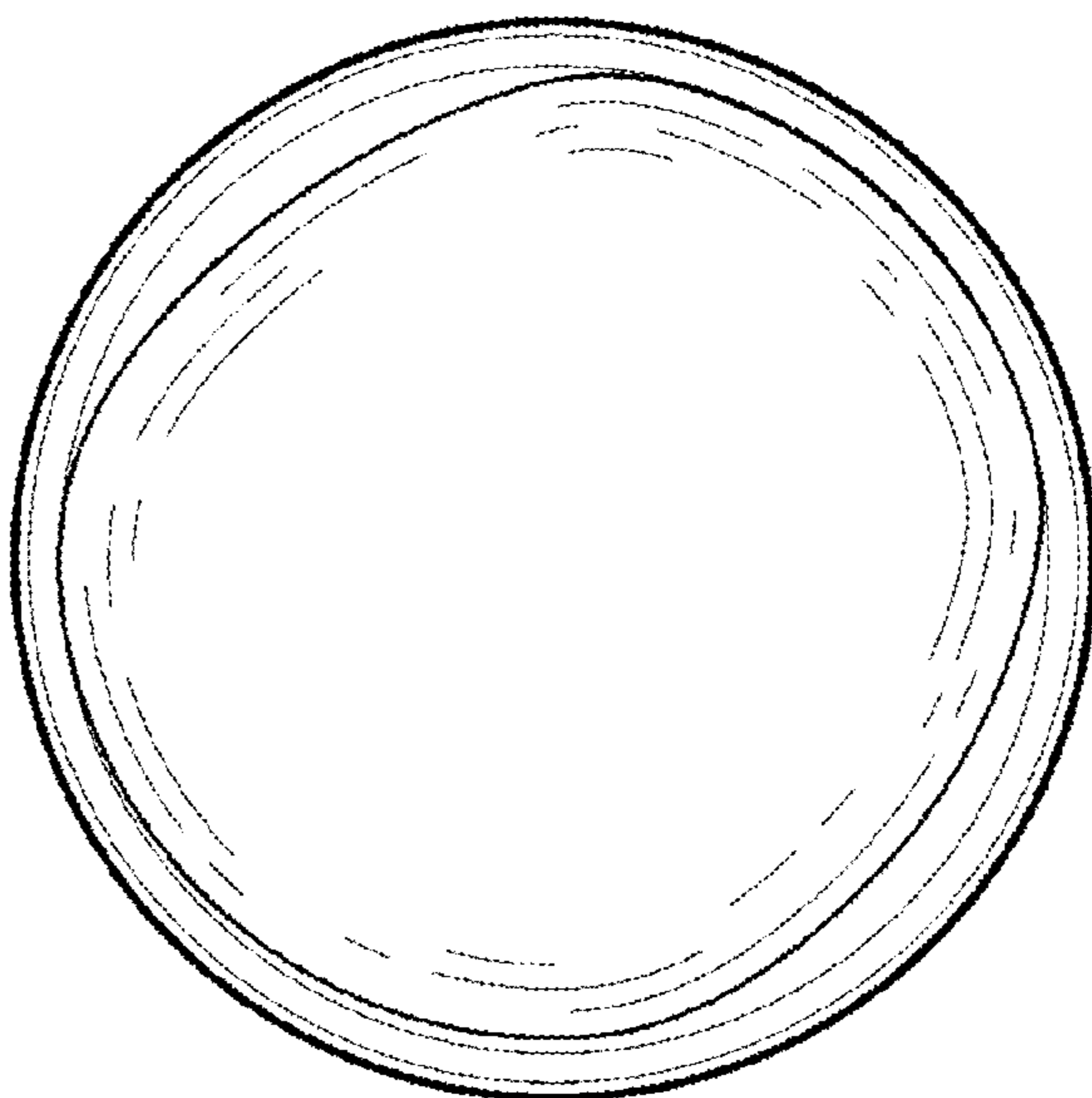
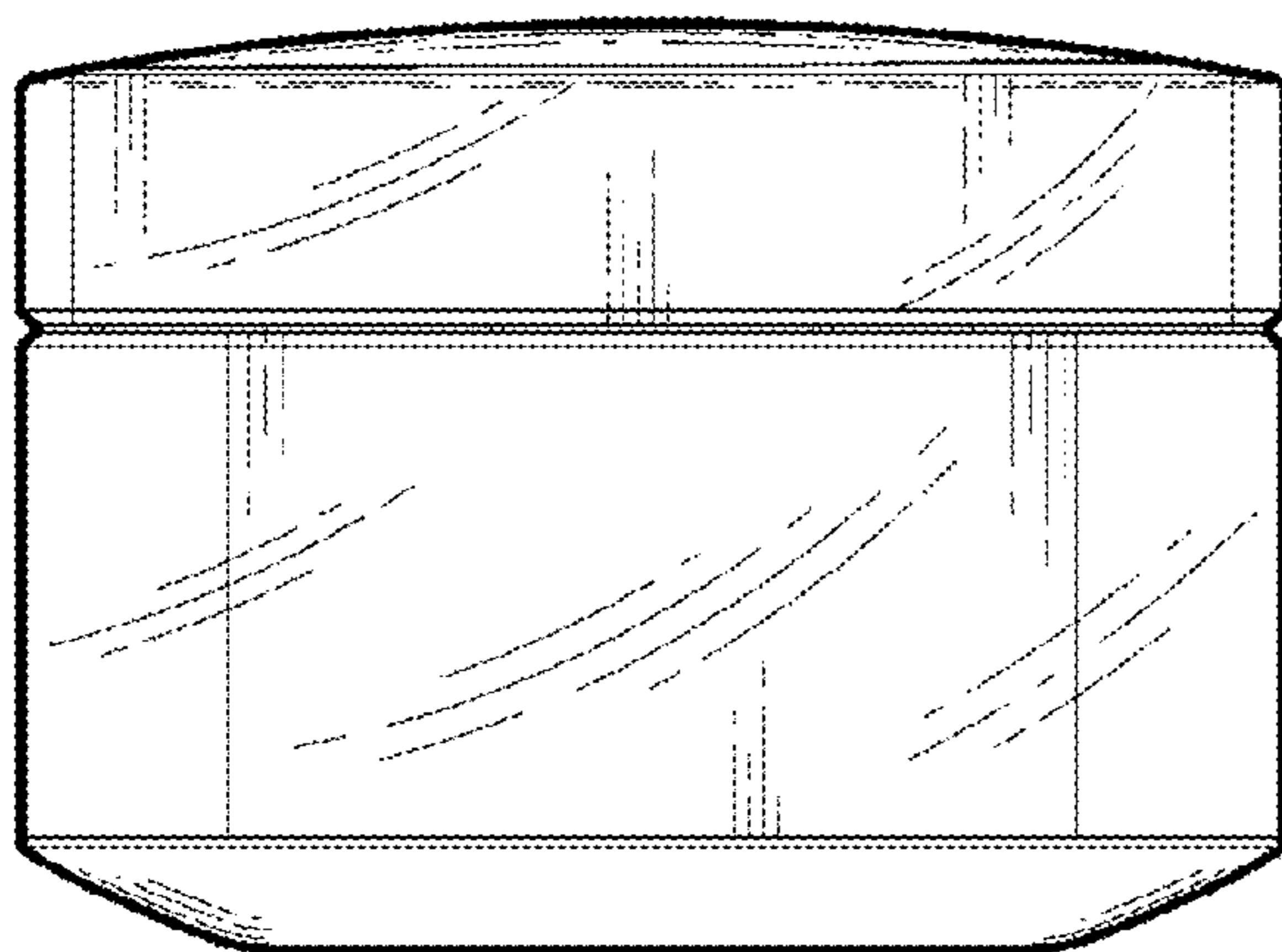

Fig. 1

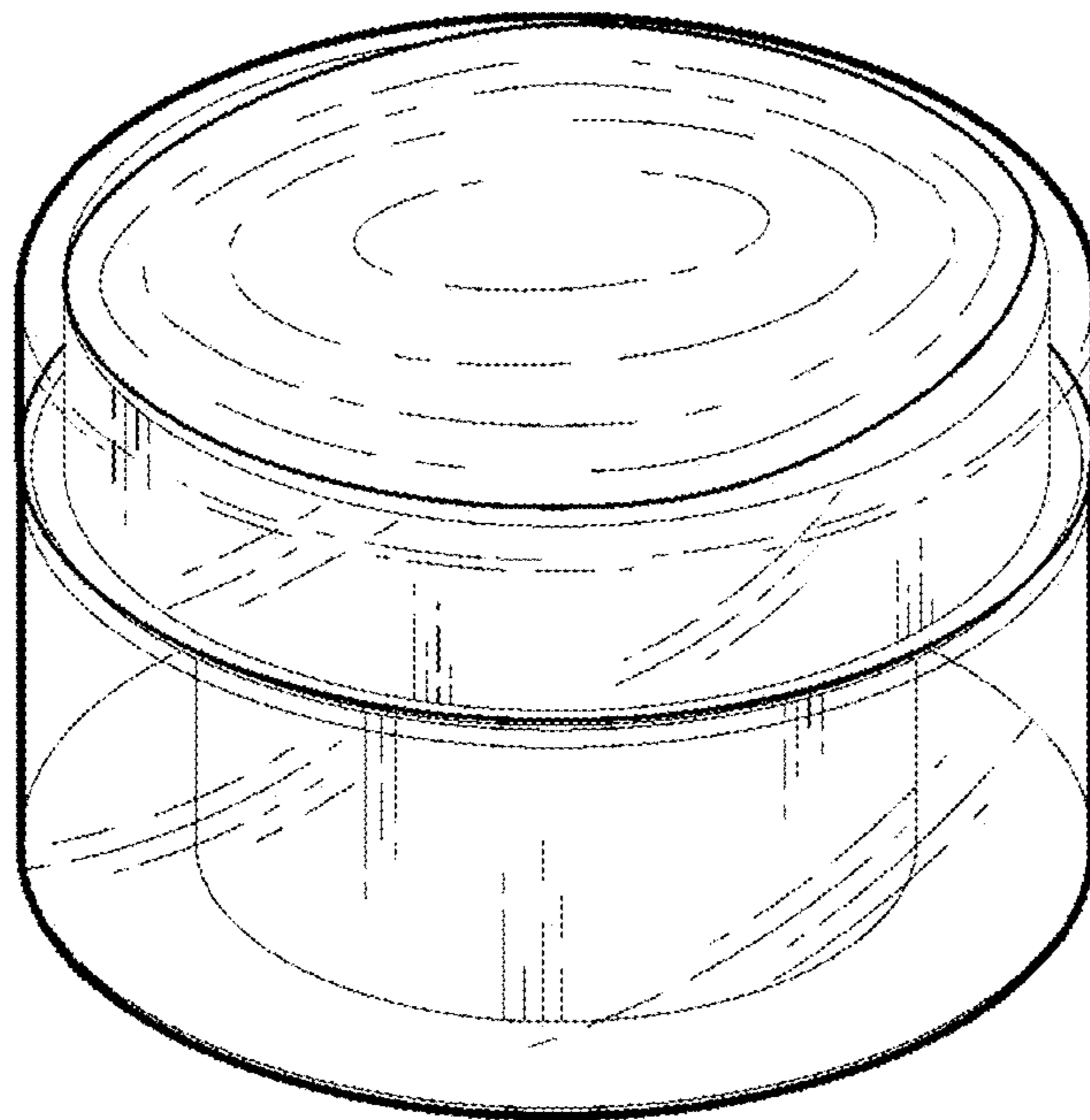

Fig. 2

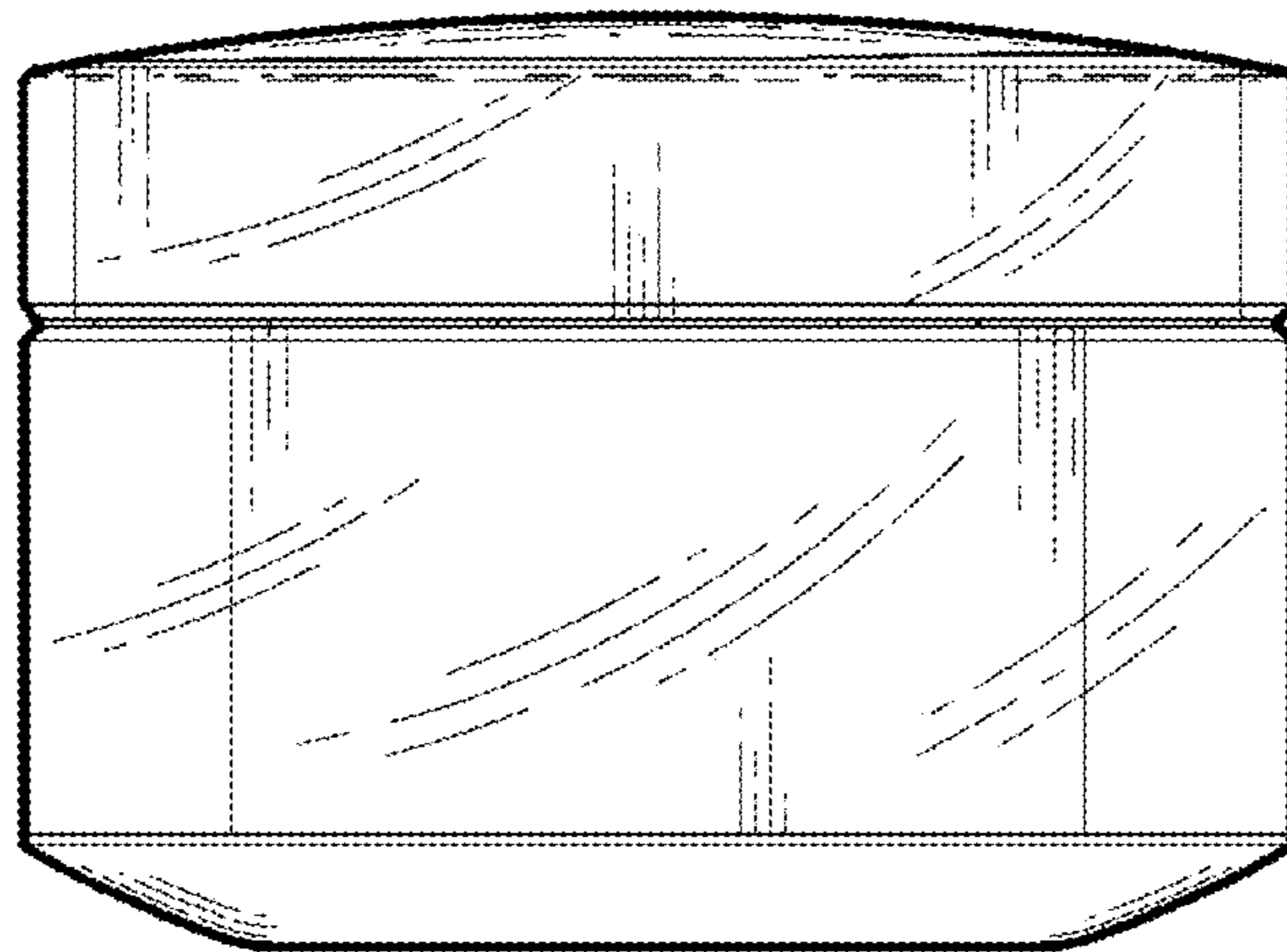

Fig. 3

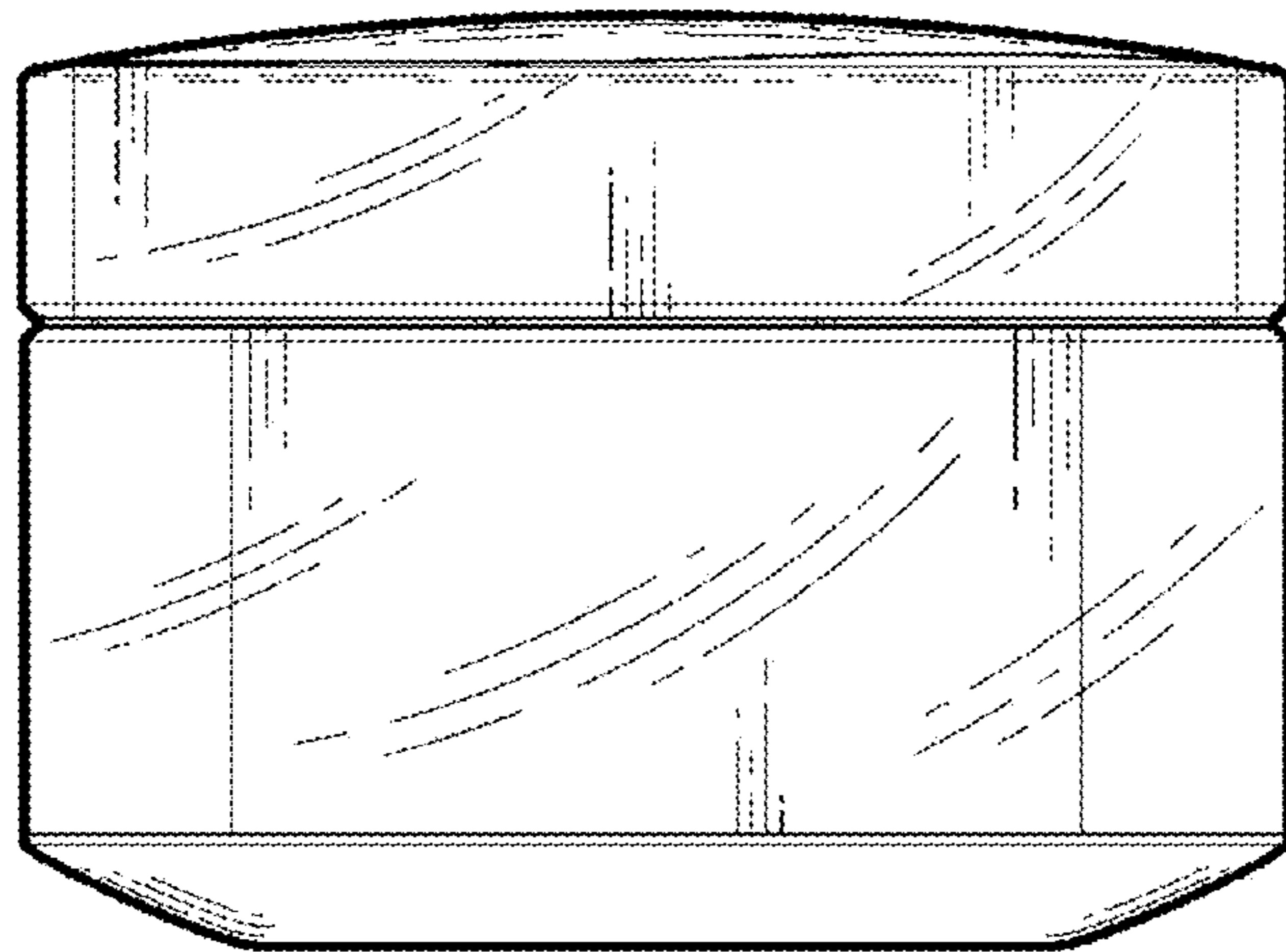

Fig. 4

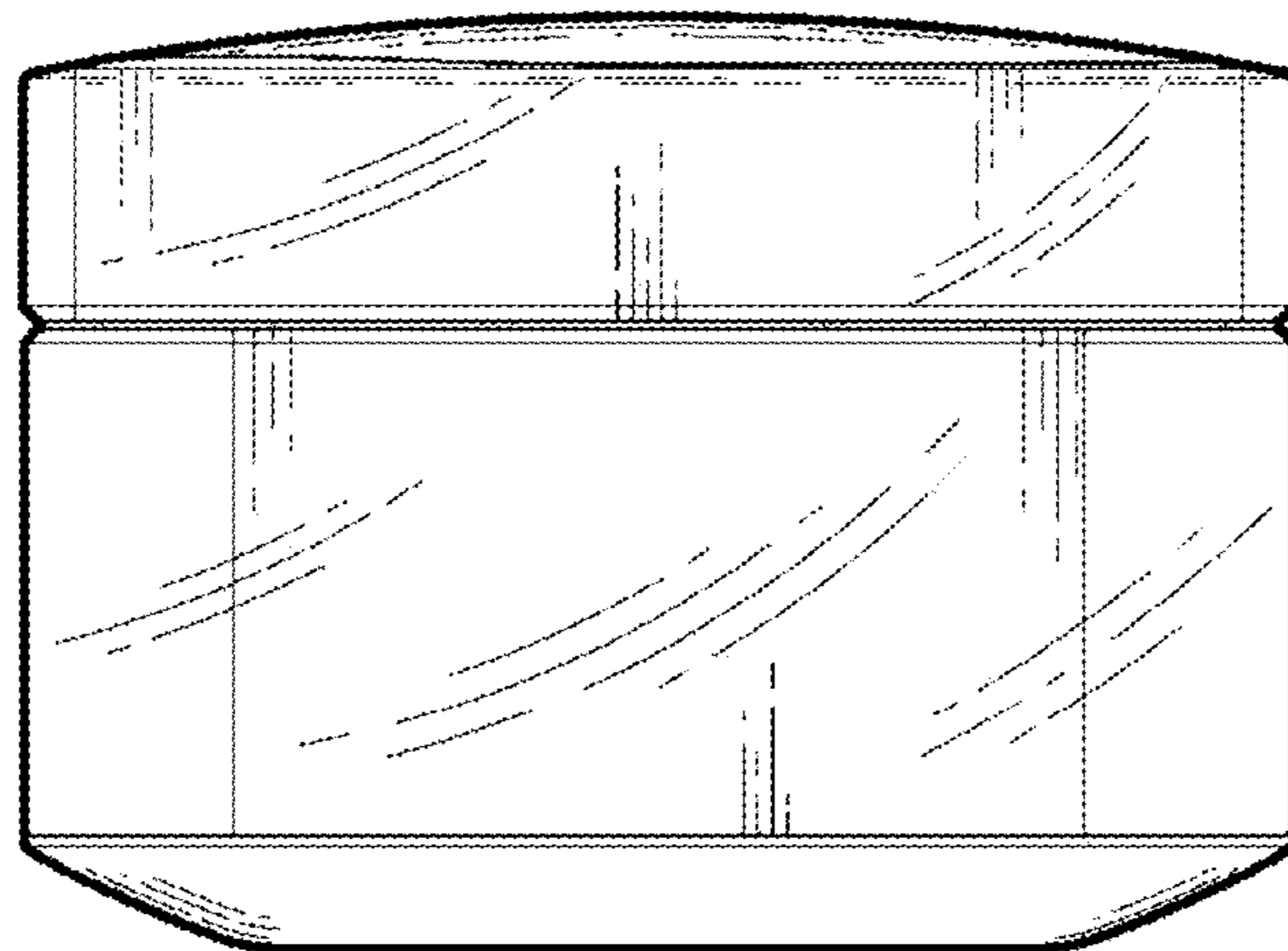

Fig. 5

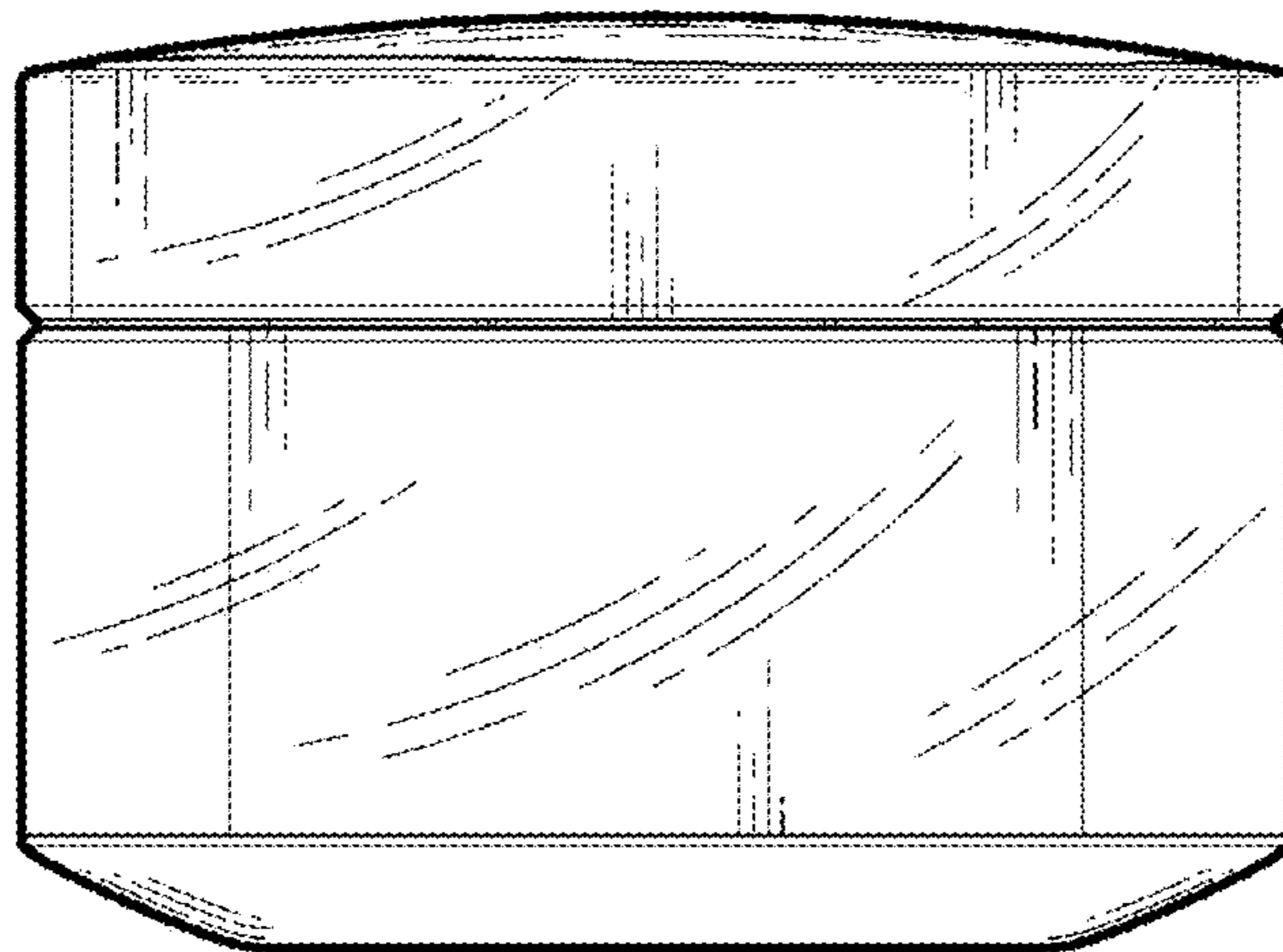

Fig. 6

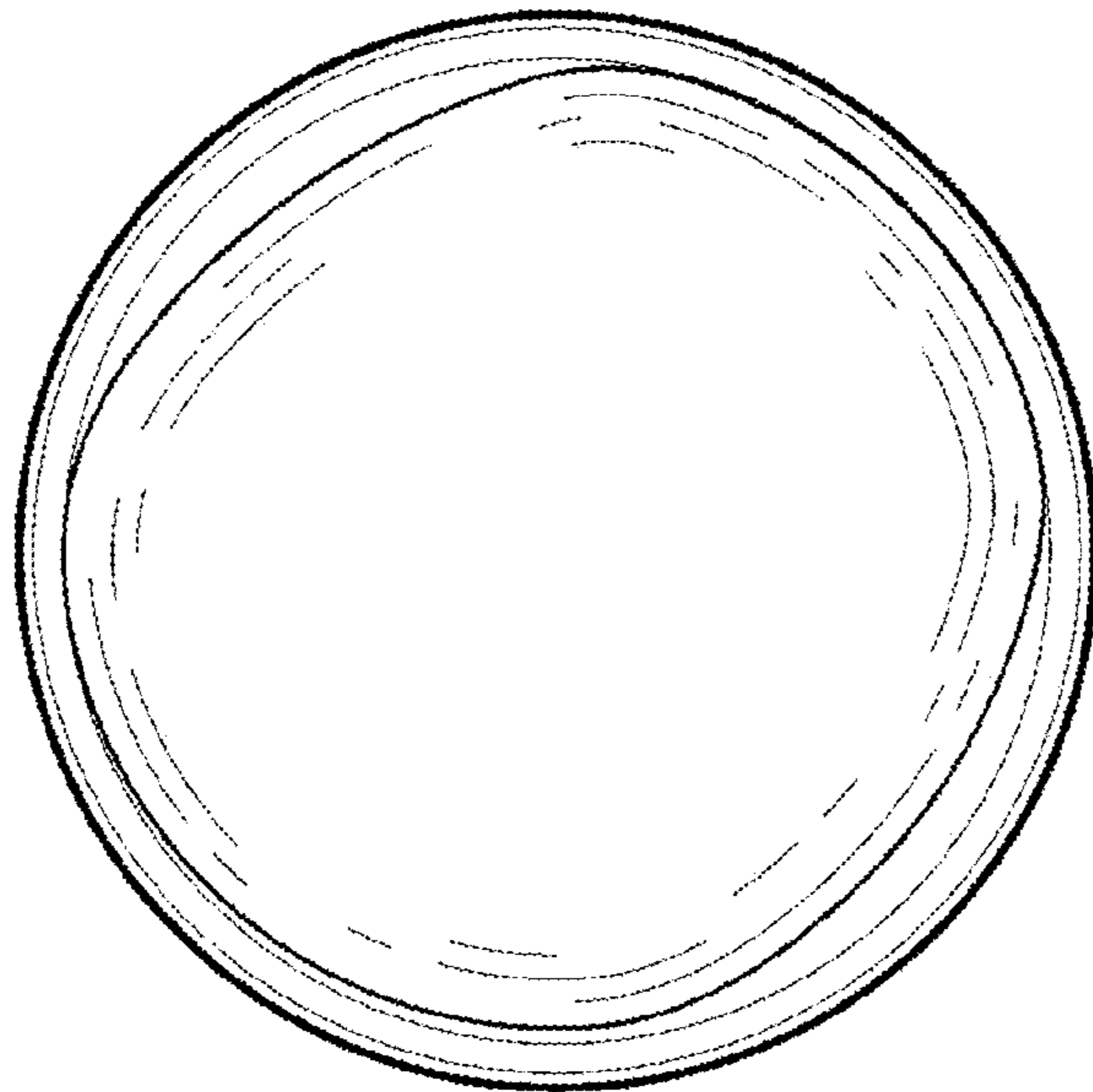

Fig. 7

