



US00D702435S

(12) **United States Design Patent**
Kriemler

(10) **Patent No.:** **US D702,435 S**
(45) **Date of Patent:** **** Apr. 15, 2014**

(54) **HANDBAG**

(75) Inventor: **Albert Kriemler**, St. Gallen (CH)

(73) Assignee: **Akris Ag**, St. Gallen (CH)

(**) Term: **14 Years**

(21) Appl. No.: **29/413,071**

(22) Filed: **Feb. 10, 2012**

(30) **Foreign Application Priority Data**

Aug. 11, 2011 (WO) 619166001

Aug. 11, 2011 (WO) DM/076 563

(51) **LOC (10) Cl.** **03-01**

(52) **U.S. Cl.**
USPC **D3/232**

(58) **Field of Classification Search**
USPC D3/232-233, 240-243, 245-246;
150/100, 103-110, 113-114, 117-119
See application file for complete search history.

(56) **References Cited**

U.S. PATENT DOCUMENTS

D447,627 S * 9/2001 Haapala D3/246

D487,542 S * 3/2004 Slimane D3/246

D493,614 S * 8/2004 Peng D3/246

D535,098 S * 1/2007 Maier D3/246

D610,803 S * 3/2010 Shing D3/245

* cited by examiner

Primary Examiner — Holly Baynham

(74) *Attorney, Agent, or Firm* — Buchanan Ingersoll & Rooney PC

(57) **CLAIM**

The ornamental design for a handbag, as shown and described.

DESCRIPTION

FIG. 1 is a front elevational view of an embodiment of a handbag according to my new design, in a fully closed position, the rear view of which is a mirror image thereof,

FIG. 2 is a front perspective view thereof, in a fully closed position,

FIG. 3 is side elevational view thereof, the other side being a mirror image thereof, in a fully closed position,

FIG. 4 is a top elevational view thereof, in a fully closed position,

FIG. 5 is a front elevational view thereof, in a semi-closed position, showing optional surface treatment, the rear view of which is a mirror image thereof,

FIG. 6 is a side perspective view thereof, in a semi-closed position, the other side being a mirror image thereof,

FIG. 7 is a top elevational view thereof, in a semi-closed position,

FIG. 8 is a front elevational view of the handbag;

FIG. 9 is a rear elevational view of the handbag;

FIG. 10 is a side perspective view thereof, in a second semi-closed position, showing optional surface treatment,

FIG. 11 is a side elevational view thereof, in a second semi-closed position,

FIG. 12 is a top elevational view thereof, in a second semi-closed position,

FIG. 13 is a side elevational view of an embodiment of a handbag according to my new design in a fully opened position,

FIG. 14 is a side perspective view thereof, in a fully opened position, showing optional surface treatment,

FIG. 15 is a side perspective view thereof, in a fully opened position, showing the handles fully extended,

FIG. 16 is a top elevational view thereof, in a fully opened position with the handles not fully extended; and,

FIG. 17 is a bottom view thereof.

The broken lines showing stitching are part of the claimed design.

1 Claim, 10 Drawing Sheets

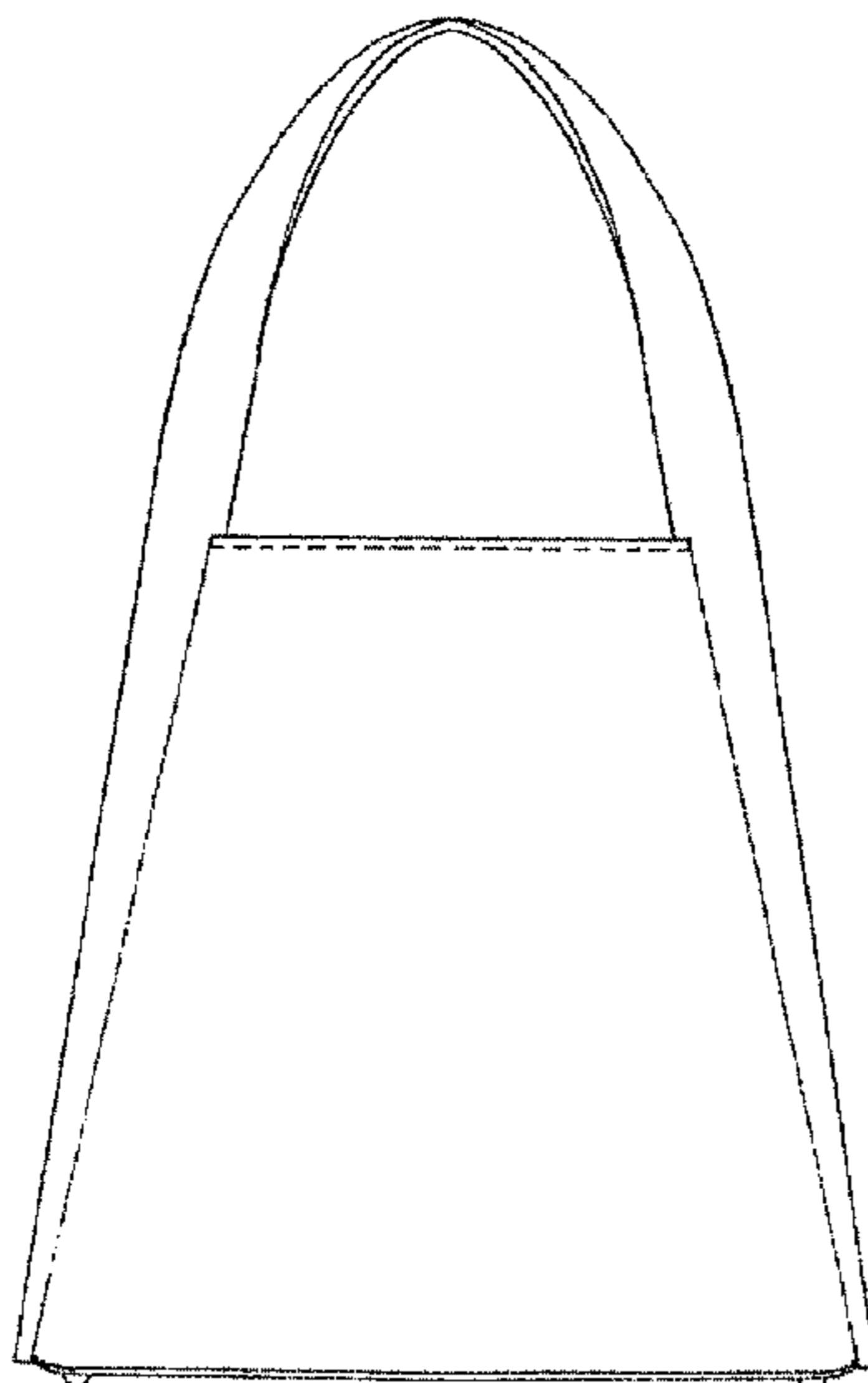

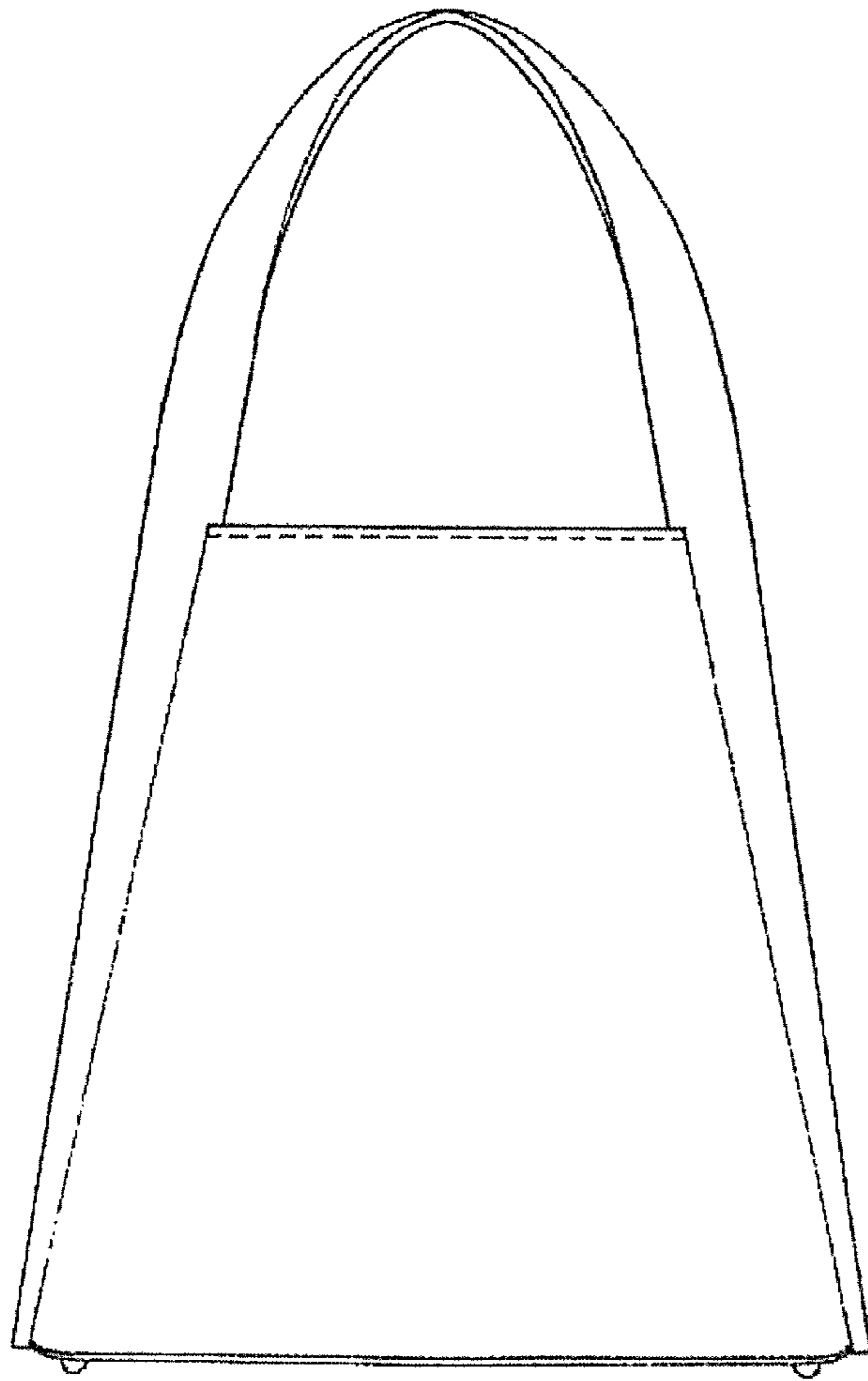

FIG. 1

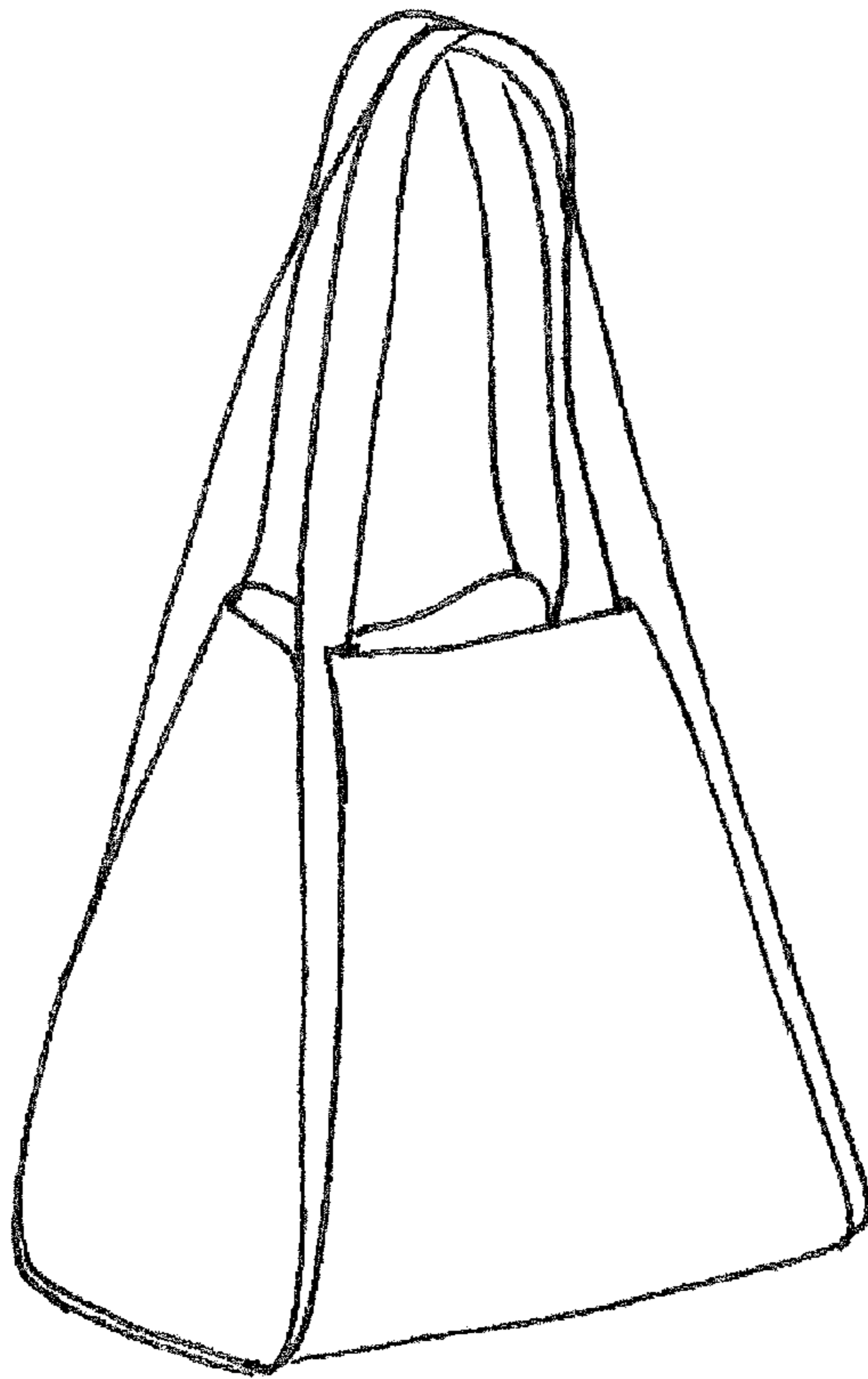

FIG. 2

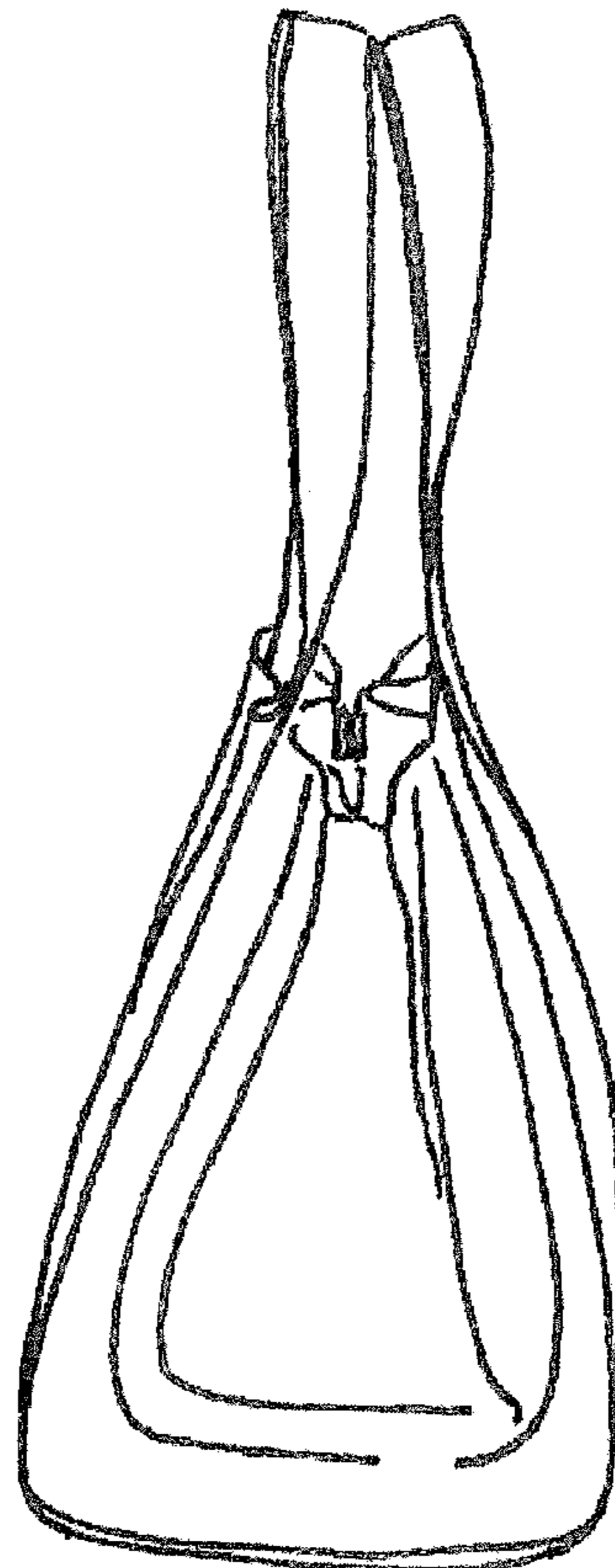

FIG. 3

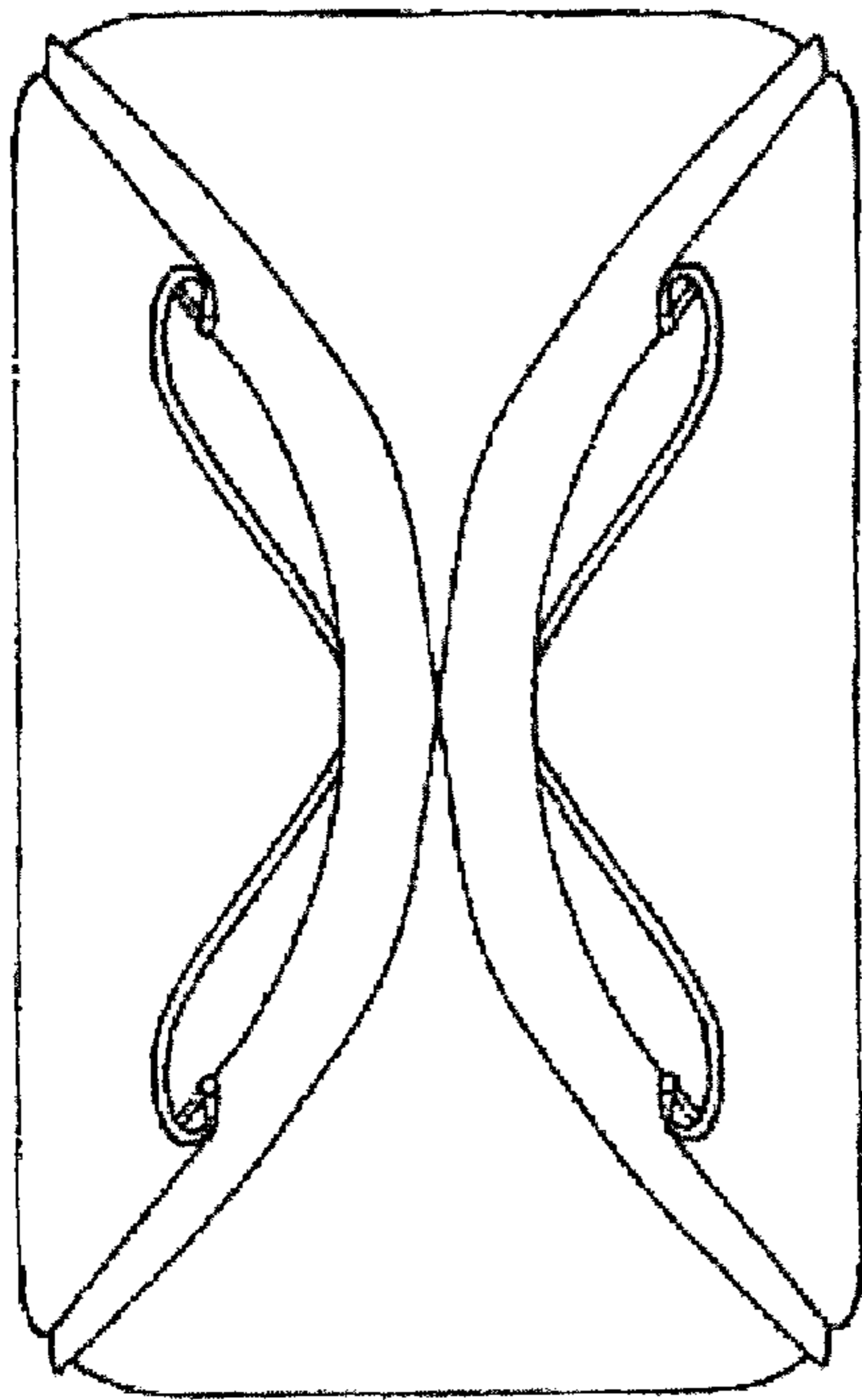

FIG. 4

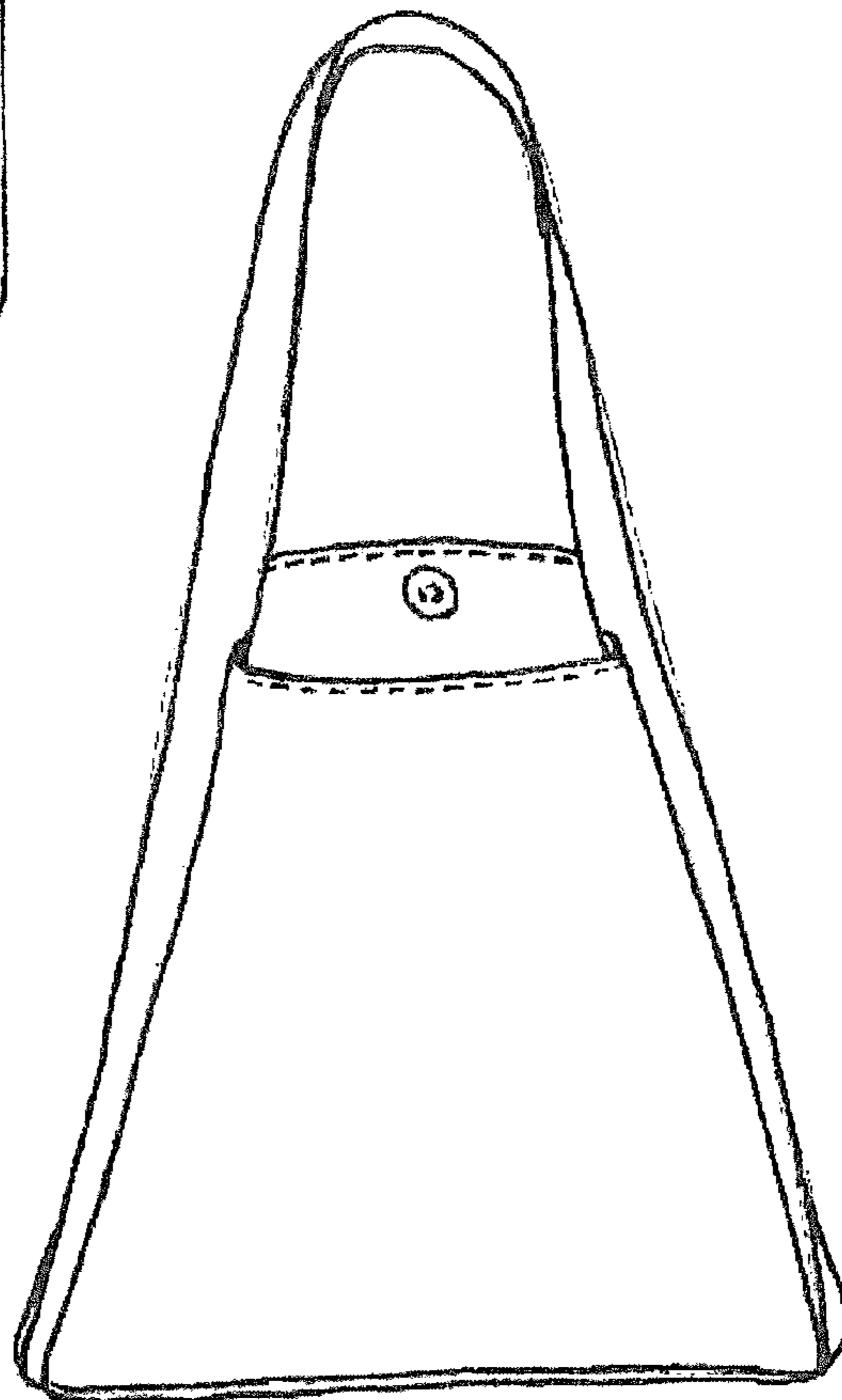

FIG. 5

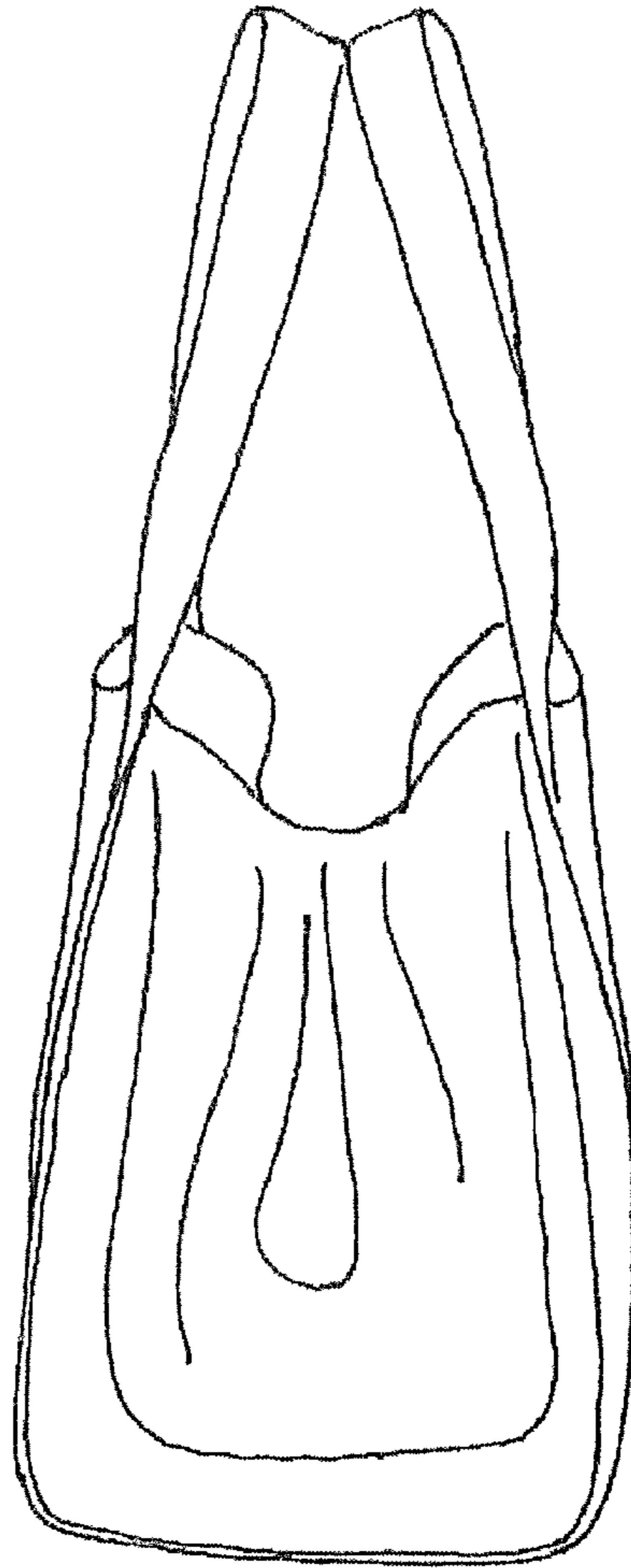

FIG. 6

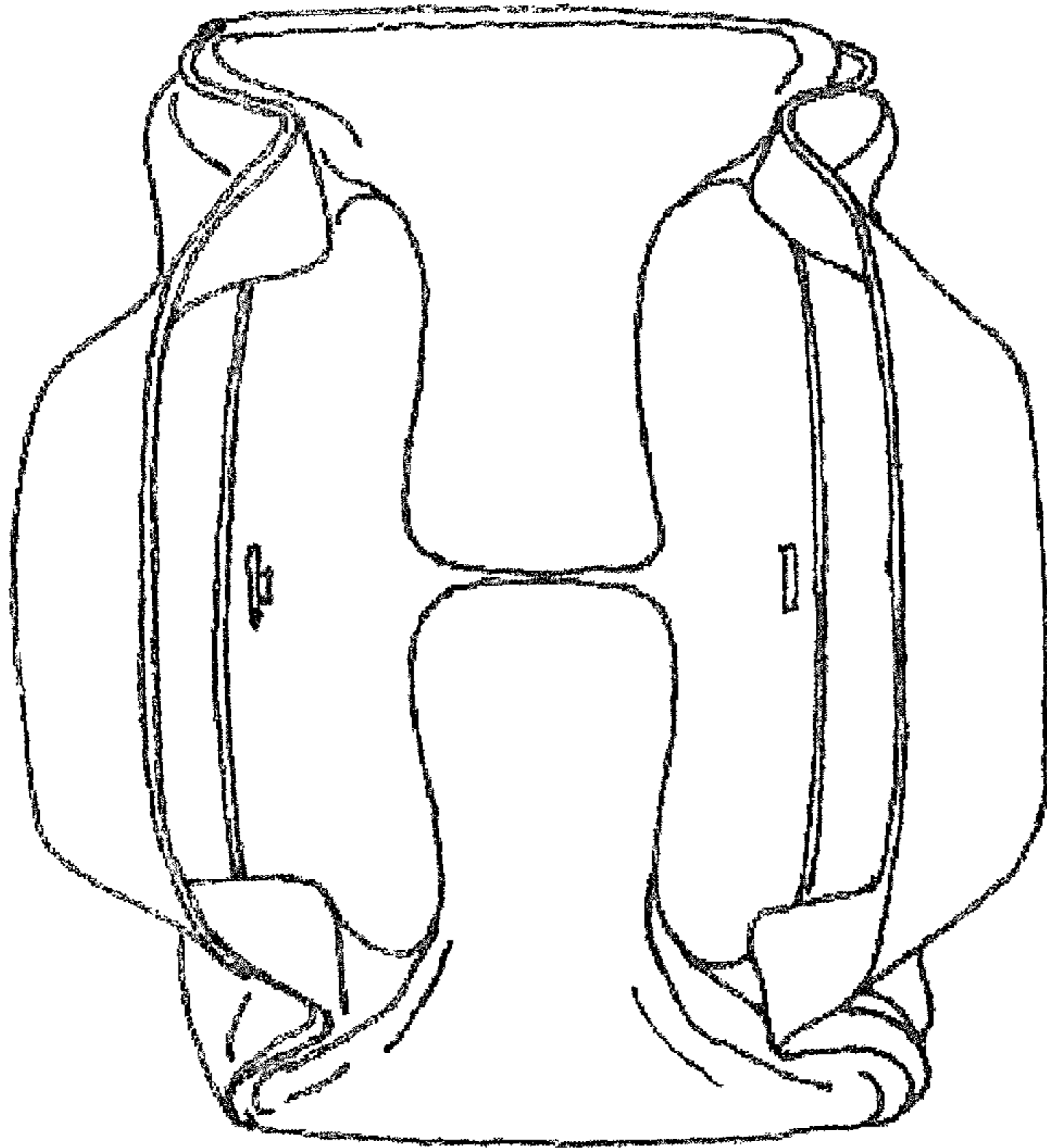

FIG. 7

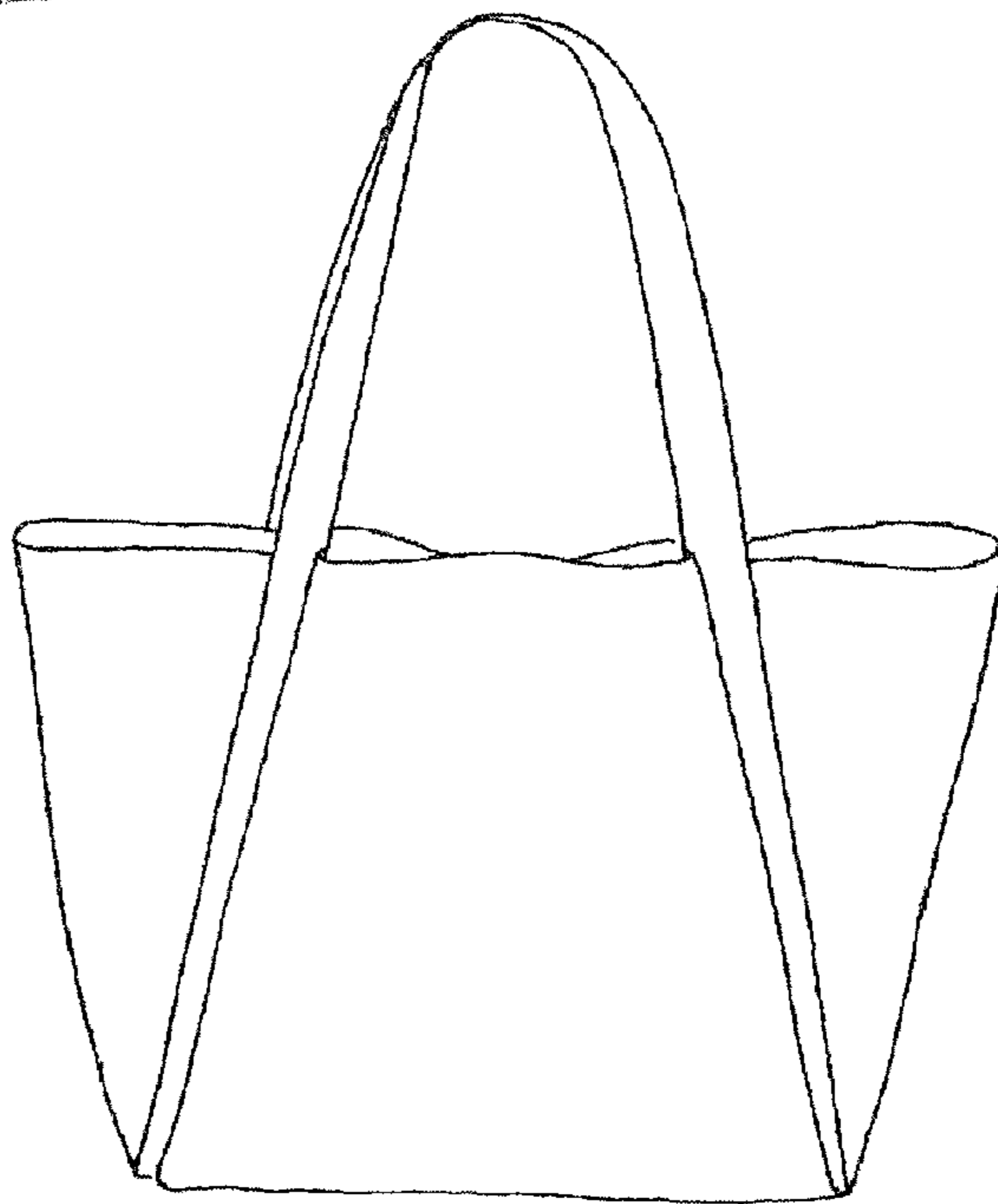

FIG. 8

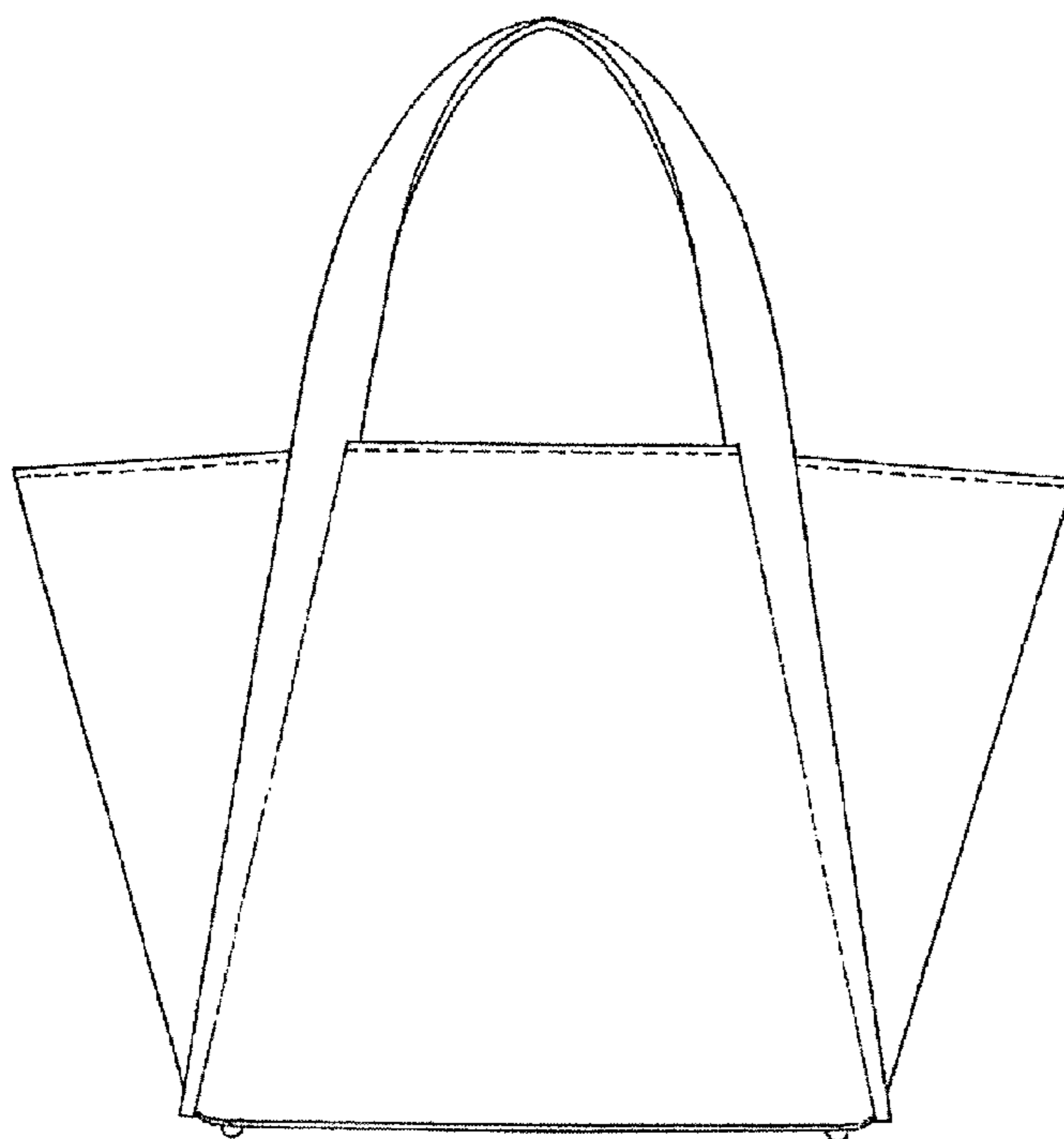

FIG. 9

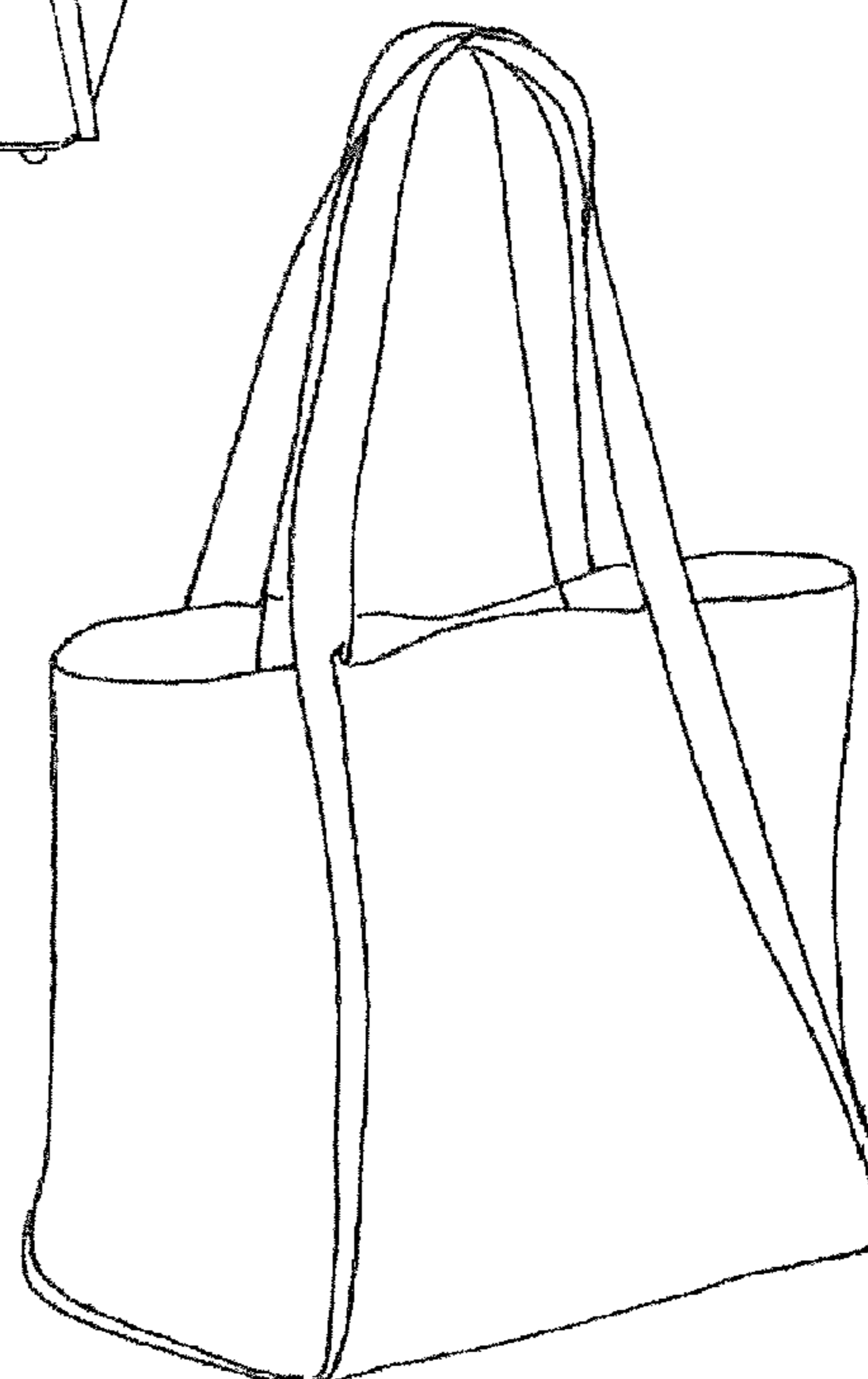

FIG. 10

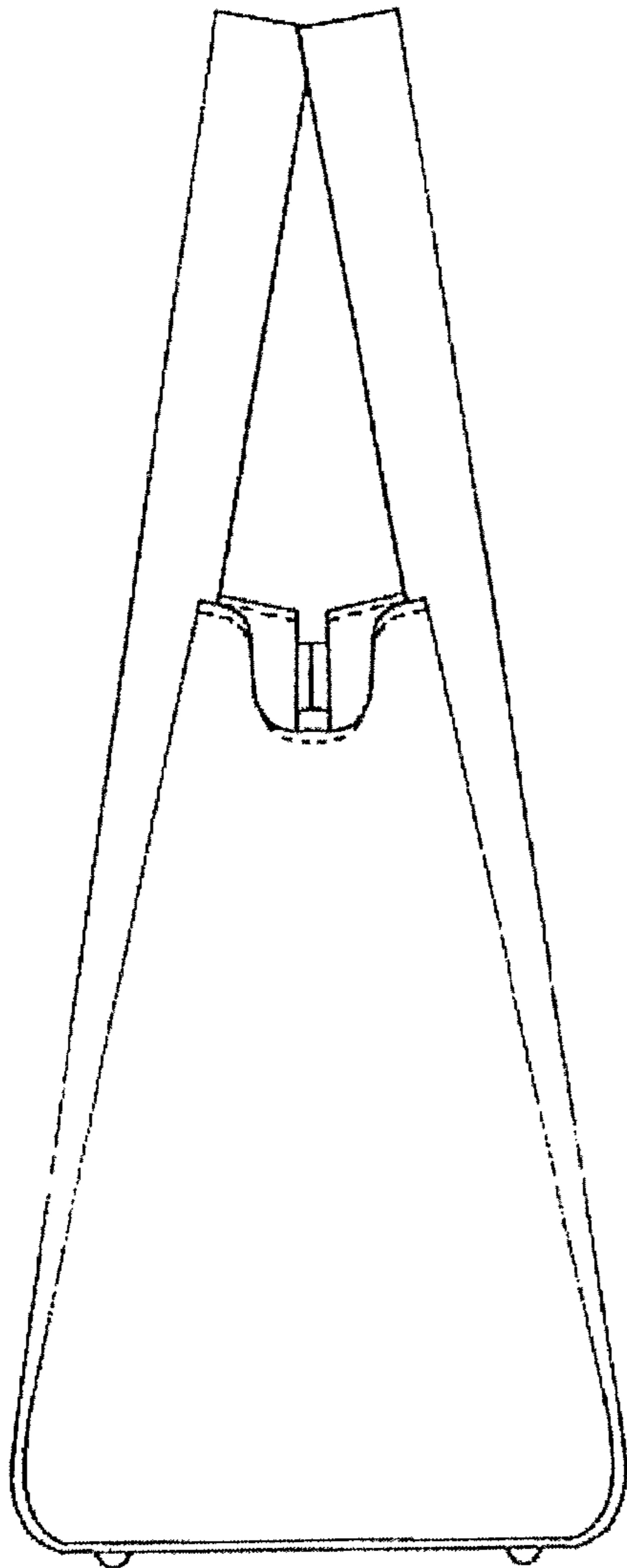

FIG. 11

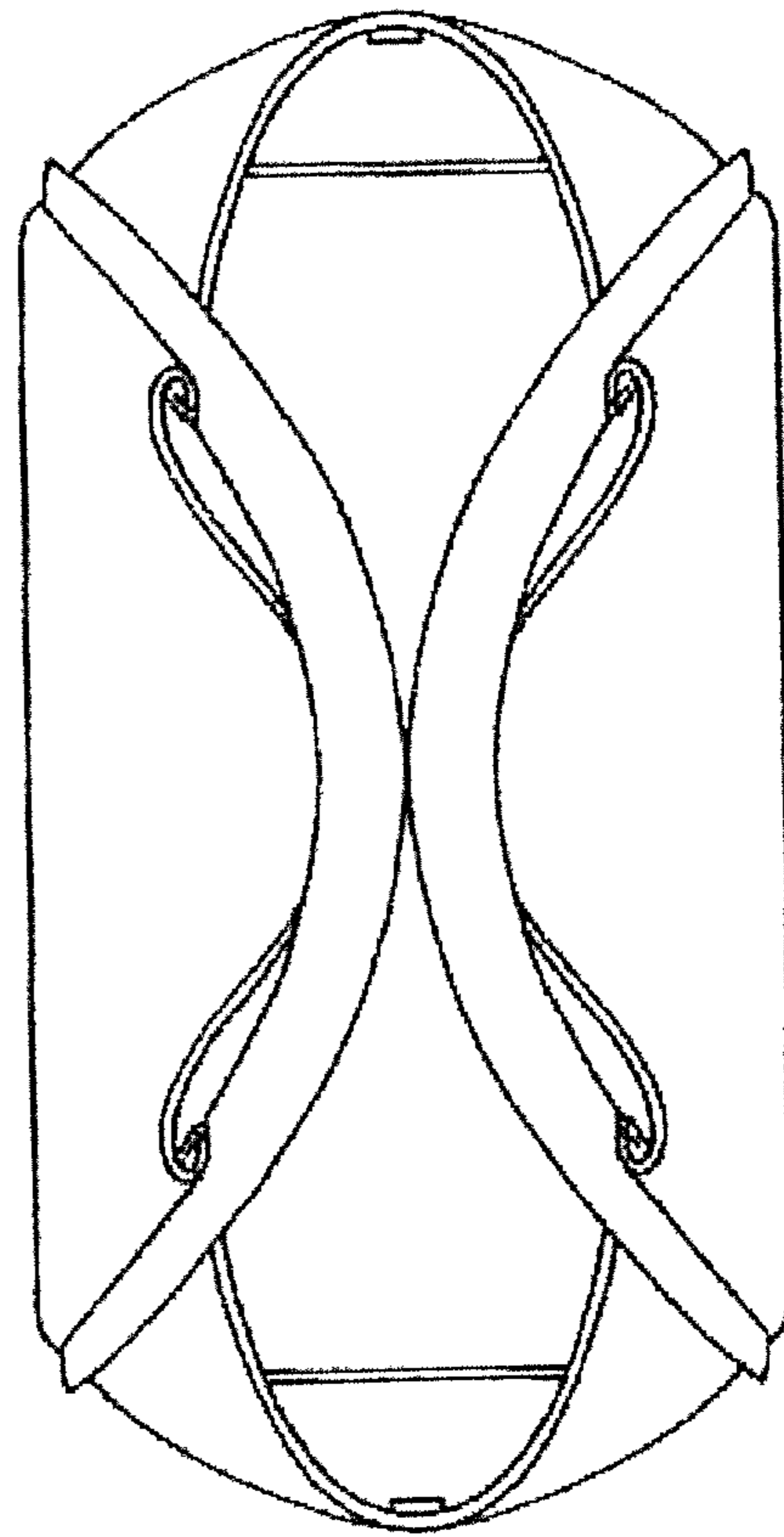

FIG. 12

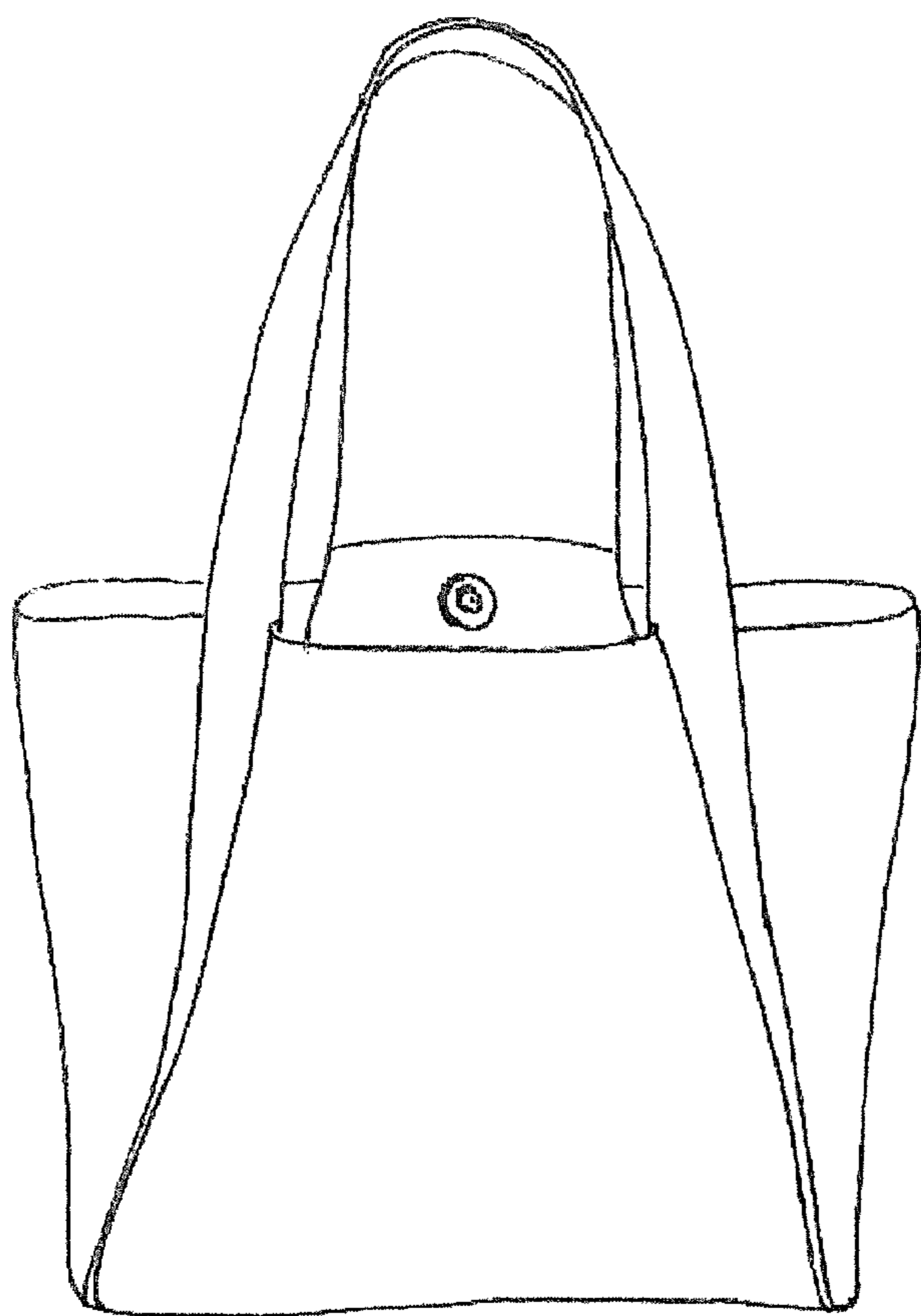

FIG. 13

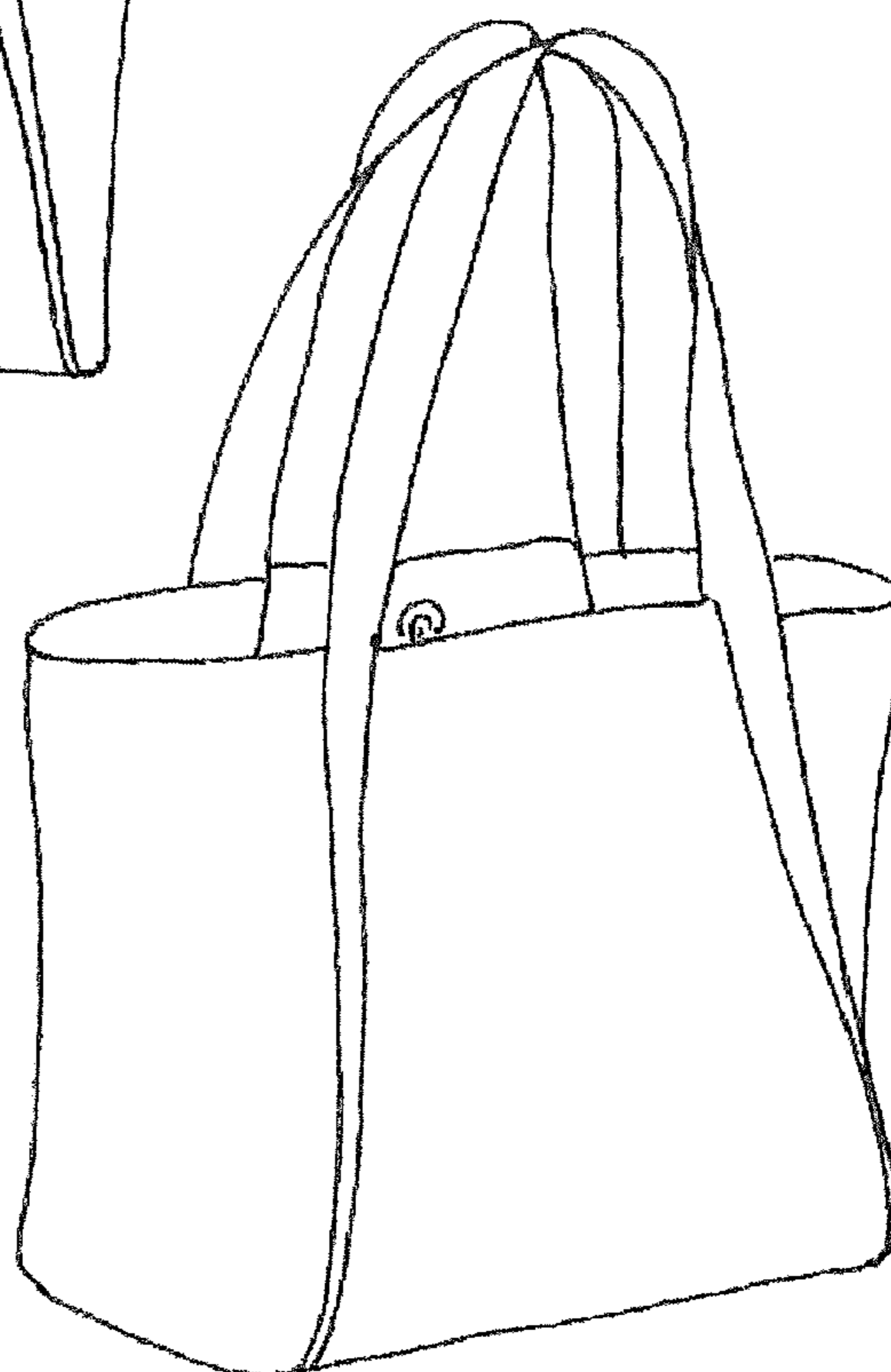

FIG. 14

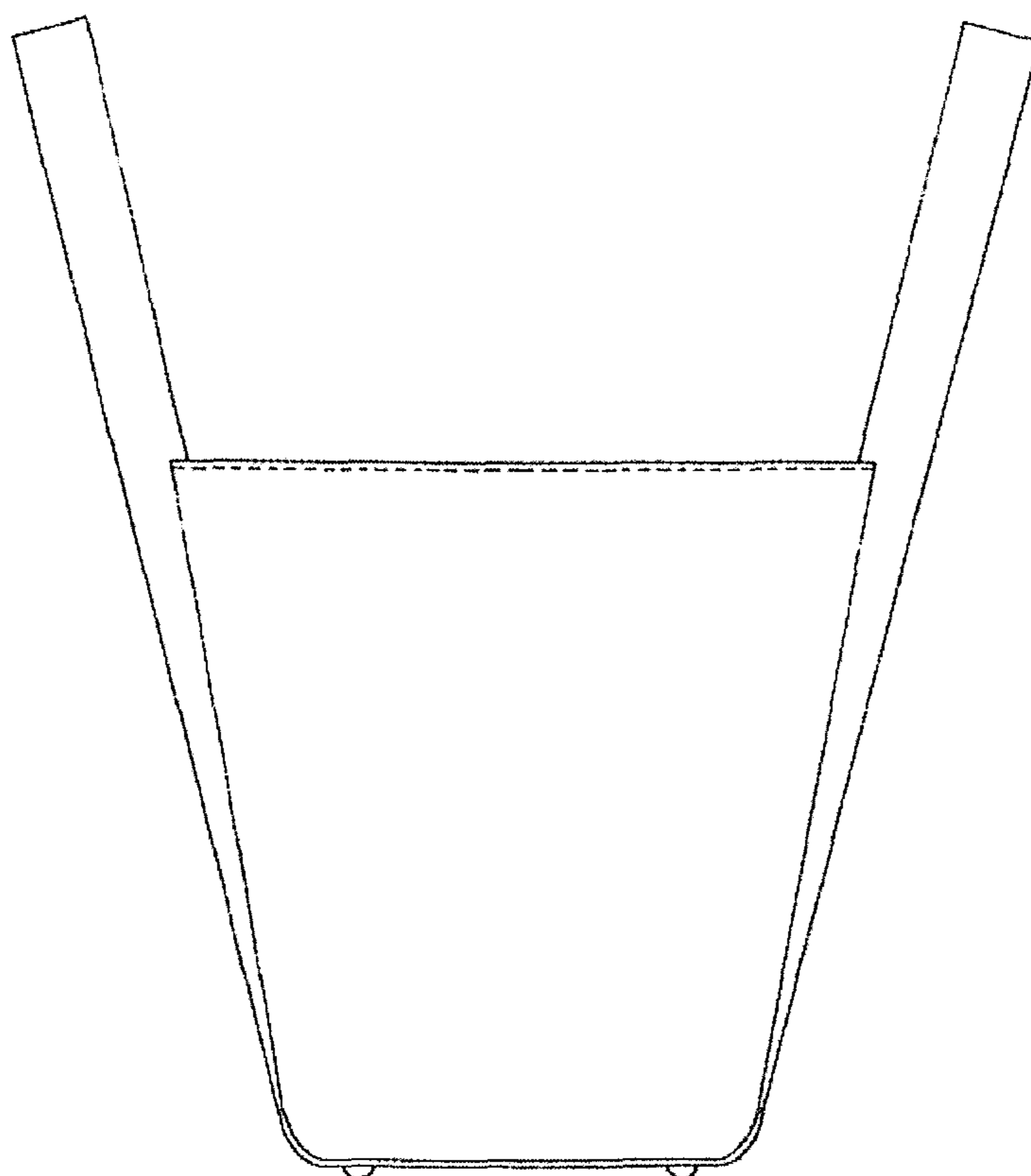

FIG. 15

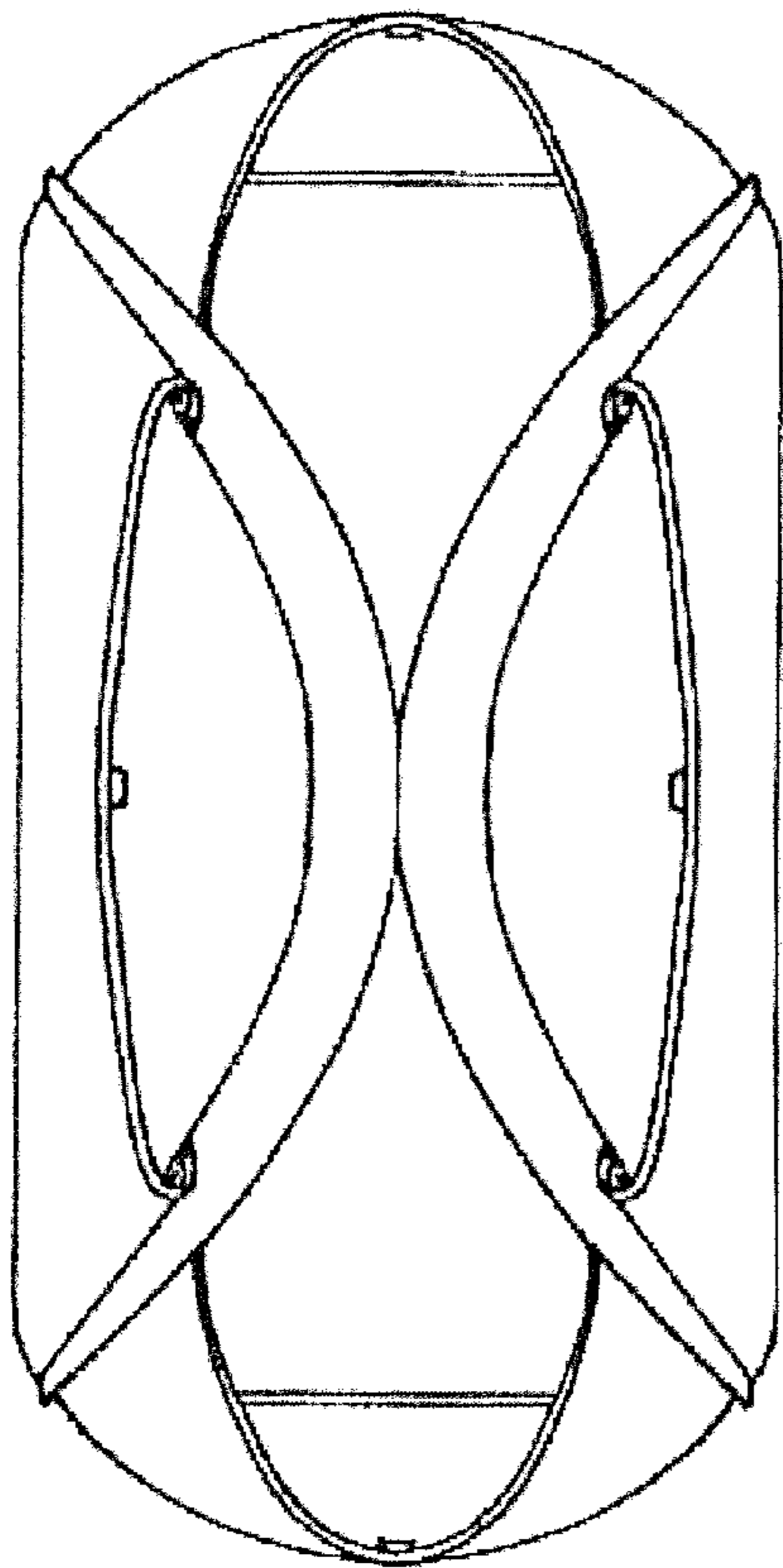

FIG. 16

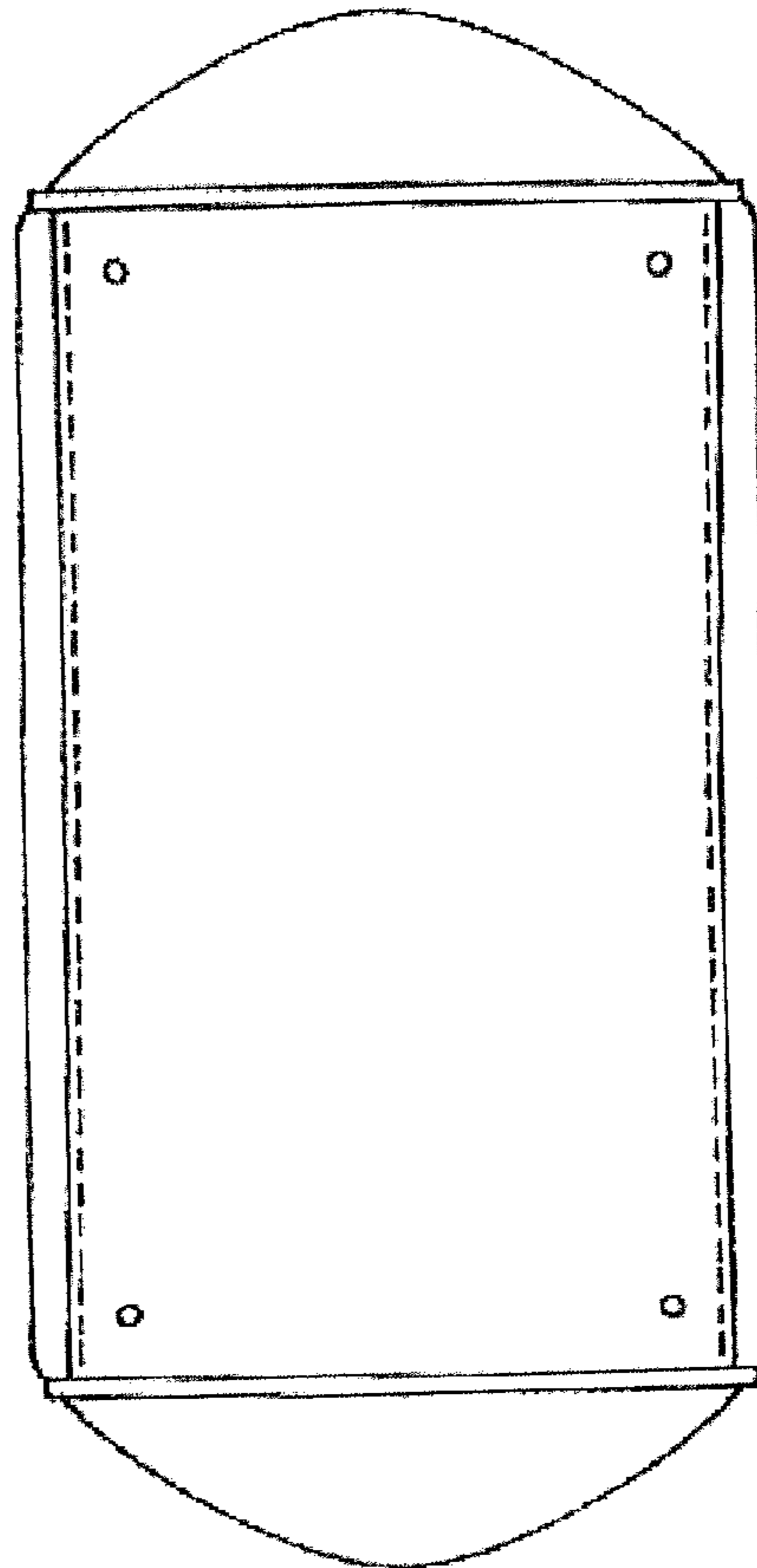

FIG. 17