



US00D702388S

(12) **United States Design Patent**
Ng et al.

(10) **Patent No.:** **US D702,388 S**
(45) **Date of Patent:** **** Apr. 8, 2014**

(54) **LAMP**

(75) Inventors: **Kenneth Ng**, Alhambra, CA (US);
Edmund Ng, Pasadena, CA (US); **Peter Ng**, Hong Kong (CN)

(73) Assignee: **Koncept Technologies Inc.**, Monrovia, CA (US)

(**) Term: **14 Years**

(21) Appl. No.: **29/405,166**

(22) Filed: **Oct. 28, 2011**

(51) **LOC (10) Cl.** **26-03**

(52) **U.S. Cl.**
USPC **D26/75**

(58) **Field of Classification Search**
USPC D26/1-3, 24, 56, 72, 74-86, 88-91;
D13/180, 182; 362/150,
362/217.01-217.05, 217.08, 217.09, 260,
362/364, 365, 366, 404, 555, 576, 800
See application file for complete search history.

(56) **References Cited**

U.S. PATENT DOCUMENTS

D169,999	S	*	7/1953	Ainsworth	D26/78
5,934,787	A	*	8/1999	Sharma	362/147
6,083,021	A	*	7/2000	Lau	439/227
6,523,975	B1	*	2/2003	Plourde et al.	362/225
D547,898	S	*	7/2007	Tseng	D26/78
D554,793	S	*	11/2007	Bobel	D26/76
D554,794	S	*	11/2007	Tseng	D26/78
D558,379	S	*	12/2007	Citterio	D26/76
D575,892	S	*	8/2008	Chandler	D26/84
D584,848	S	*	1/2009	Menke	D26/88

D589,640	S	*	3/2009	Janssen	D26/90
D595,443	S	*	6/2009	Tran et al.	D26/76
D613,897	S	*	4/2010	Thun	D26/88

OTHER PUBLICATIONS

Re-SM, Bartco Lighting: Manufactures of quality lighting products, <http://www.bartcolighting.com/product/re-sm>, retrieved Jan. 14, 2013, 2 pages.

Re292-BAM, Bartco Lighting: Manufactures of quality lighting products, <http://www.bartcolighting.com/product/re292-bam>, retrieved Jan. 14, 2013, 3 pages.

* cited by examiner

Primary Examiner — Zenia Bennett

(74) *Attorney, Agent, or Firm* — Foley & Lardner LLP

(57) **CLAIM**

The ornamental design for a lamp, as shown.

DESCRIPTION

FIG. 1 is a perspective view of a lamp showing our new design;

FIG. 2 is a right side view thereof;

FIG. 3 is a left side view thereof;

FIG. 4 is a front view thereof;

FIG. 5 is a rear view thereof;

FIG. 6 is a top view thereof; and,

FIG. 7 is a bottom view thereof.

Elements of the lamp have been broken away in all figures of the drawing to indicate that no particular length is claimed. Elements drawn in broken lines are understood to be for illustrative purposes only and form no part of the claimed design.

1 Claim, 6 Drawing Sheets

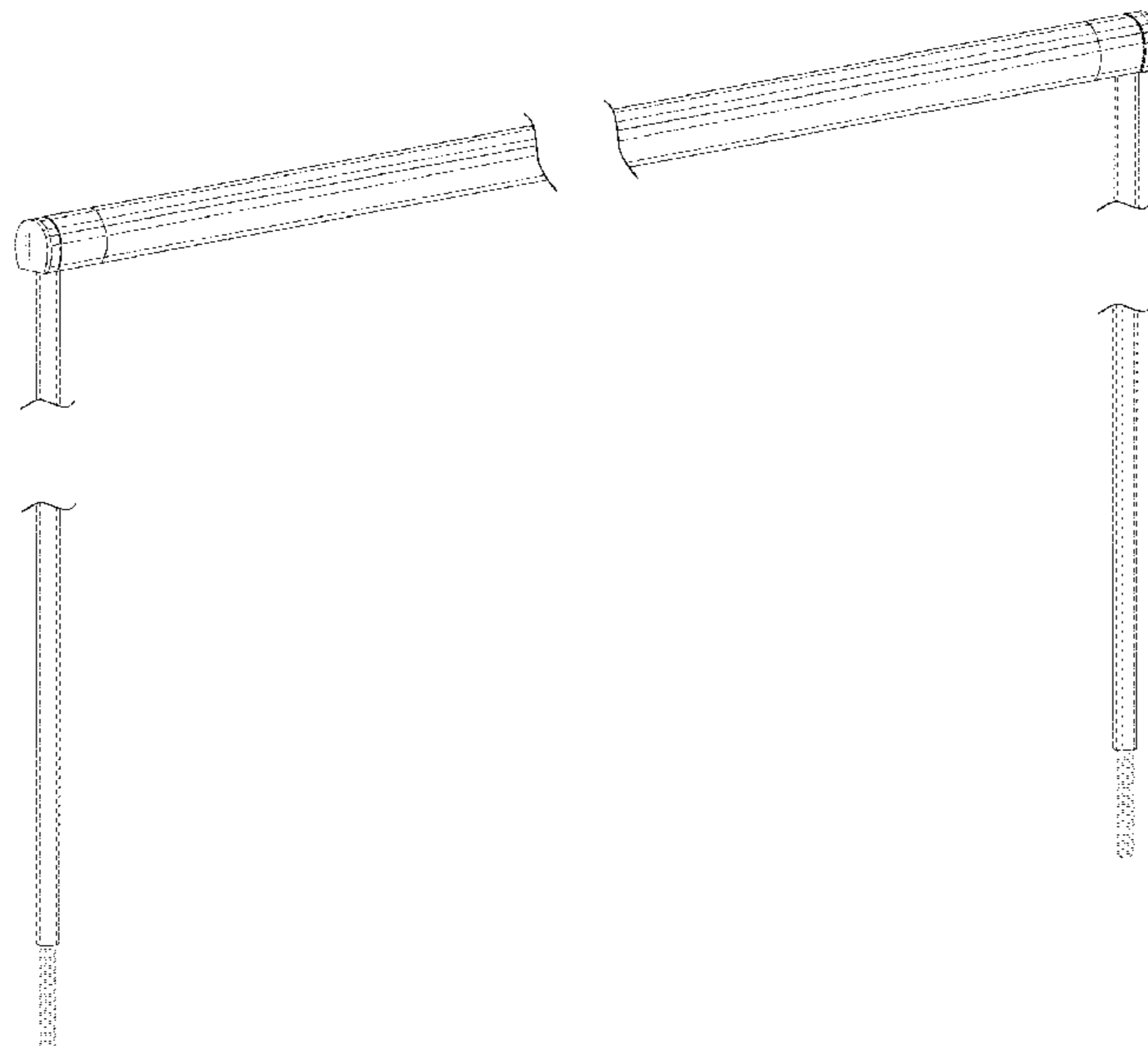

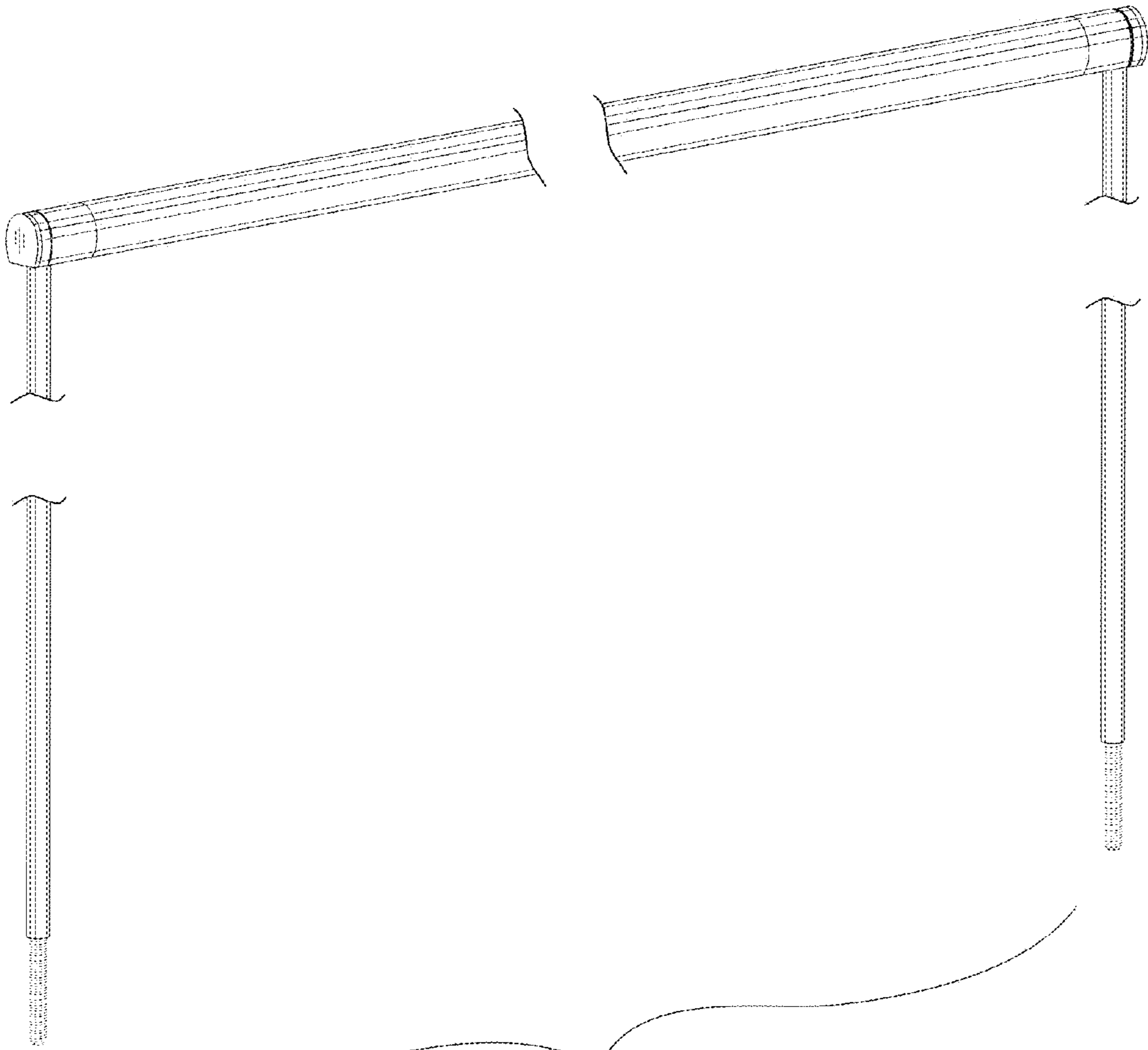

FIG. 1

FIG. 2

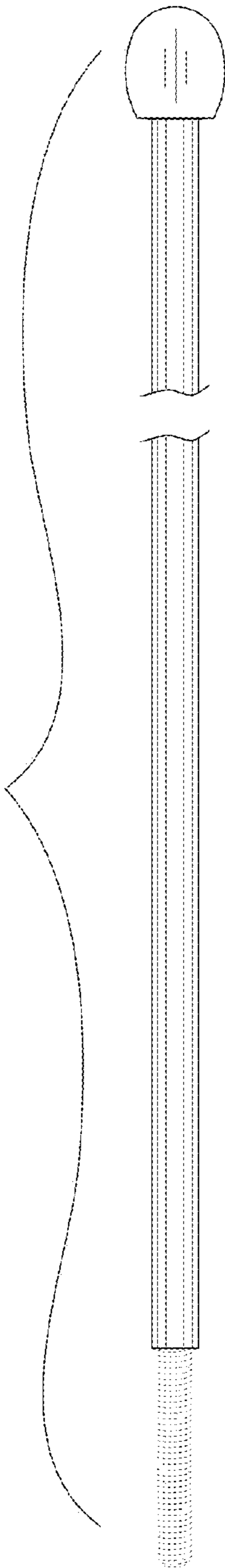
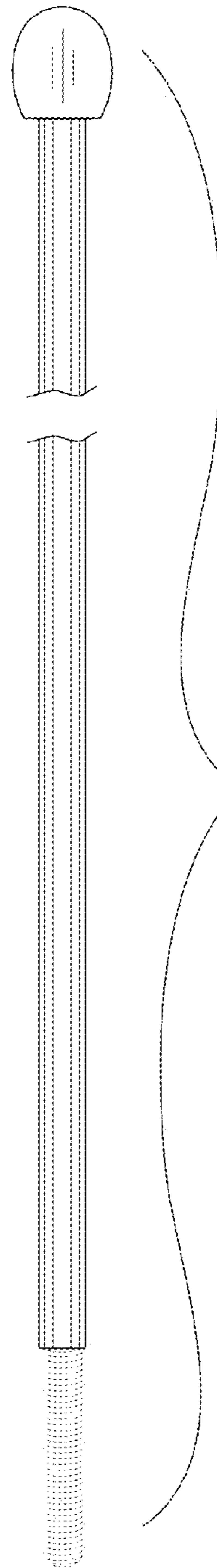

FIG. 3



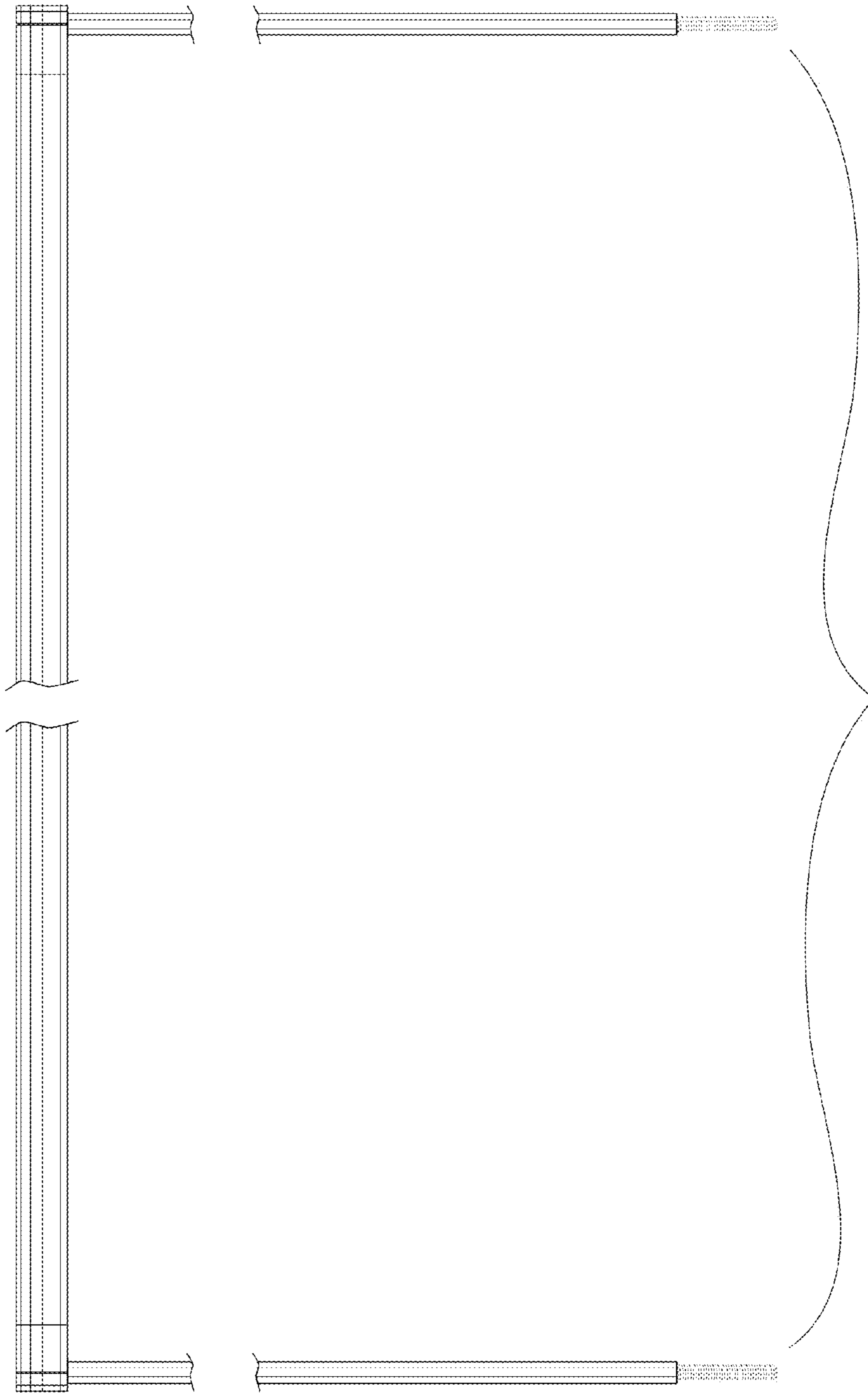

FIG. 4

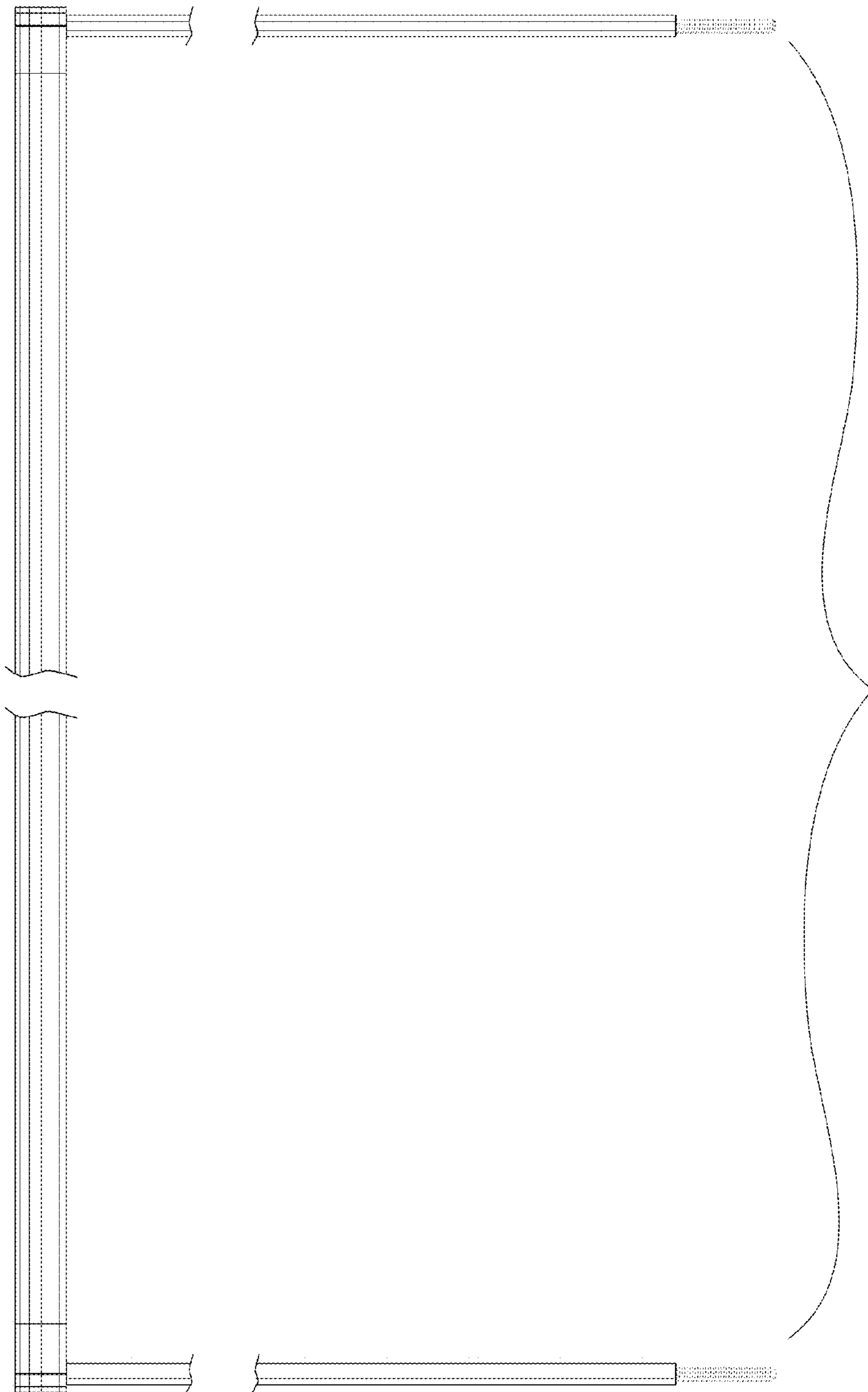

FIG. 5

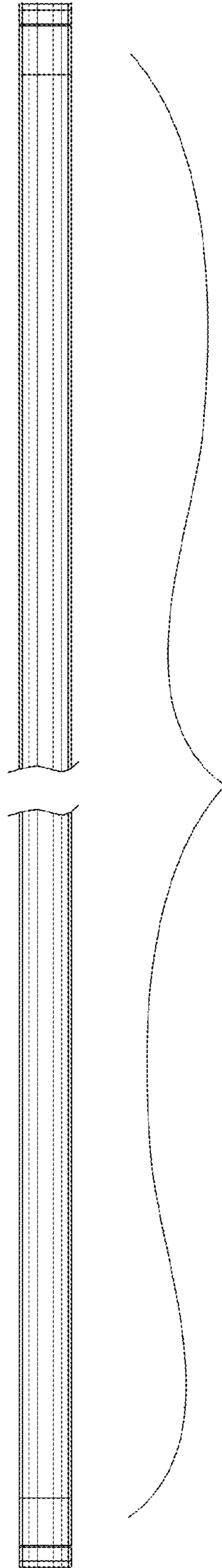

FIG. 6

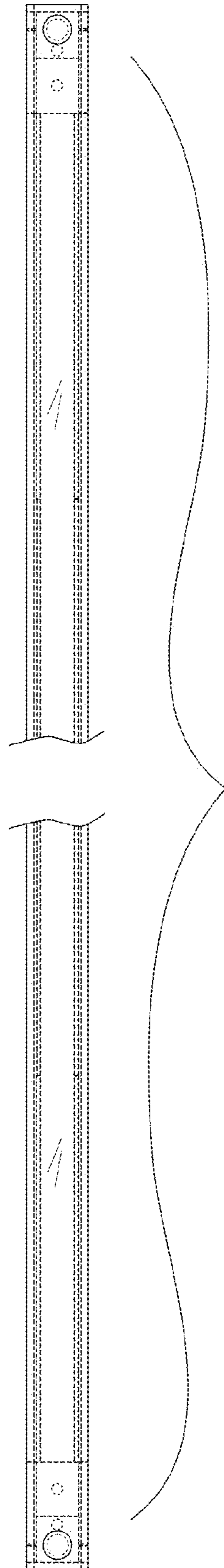

FIG. 7