



US00D702358S

(12) **United States Design Patent**
Shinohara et al.

(10) **Patent No.:** **US D702,358 S**
(45) **Date of Patent:** **** Apr. 8, 2014**

(54) **MEDICAL PROBE**

(71) Applicant: **Panasonic Corporation**, Kadoma (JP)

(72) Inventors: **Noriyuki Shinohara**, Ehime (JP); **Akira Onoda**, Ehime (JP); **Masahiko Kadokura**, Kanagawa (JP)

(73) Assignee: **Konica Minolta, Inc.**, Tokyo (JP)

(**) Term: **14 Years**

(21) Appl. No.: **29/453,773**

(22) Filed: **May 2, 2013**

(30) **Foreign Application Priority Data**

Mar. 21, 2013 (JP) 2013-006176

(51) **LOC (10) Cl.** **24-01**

(52) **U.S. Cl.**
USPC **D24/187**

(58) **Field of Classification Search**

USPC D24/107, 144, 158, 164, 165, 167, 170,
D24/186-187, 231; D10/57, 60, 78, 80;
600/407, 461, 459; 378/98.7, 98.8, 189
See application file for complete search history.

(56) **References Cited**

U.S. PATENT DOCUMENTS

4,674,517 A * 6/1987 Barnes et al. 600/459
D343,801 S * 2/1994 Burns et al. D10/78
D369,307 S * 4/1996 Imling et al. D10/78

D536,450 S * 2/2007 Ryan D24/144
D550,365 S 9/2007 Kitayama
D623,755 S * 9/2010 Ikegame D24/186

FOREIGN PATENT DOCUMENTS

JP D0892099 S 2/1994
JP D1018627 S 8/1998
JP D1133882 S 2/2002
JP D1267579 S 4/2006
JP D1285445 S 11/2006

* cited by examiner

Primary Examiner — T. Chase Nelson

Assistant Examiner — Mark Cavanna

(74) *Attorney, Agent, or Firm* — Brinks Gilson & Lione

(57) **CLAIM**

We claim the ornamental design for a medical probe, as shown and described.

DESCRIPTION

FIG. 1 is a front perspective view of a medical probe of the present invention;

FIG. 2 is a rear perspective view thereof;

FIG. 3 is a front view thereof;

FIG. 4 is a rear view thereof;

FIG. 5 is a left side view thereof;

FIG. 6 is a right side view thereof;

FIG. 7 is a top view thereof; and,

FIG. 8 is a bottom view thereof.

The broken lines shown represent unclaimed subject matter and form no part of the claimed design.

1 Claim, 8 Drawing Sheets

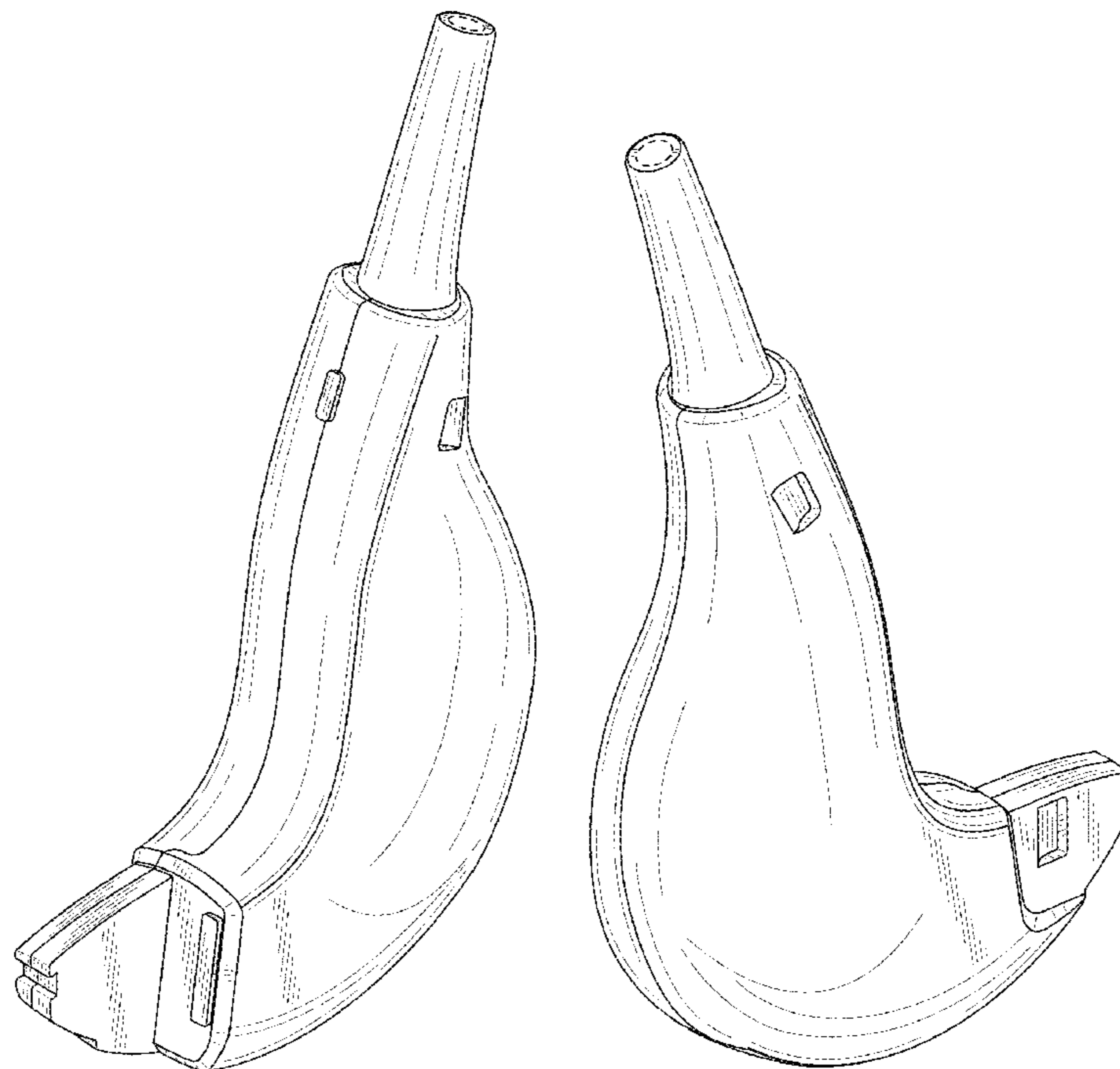

FIG. 1

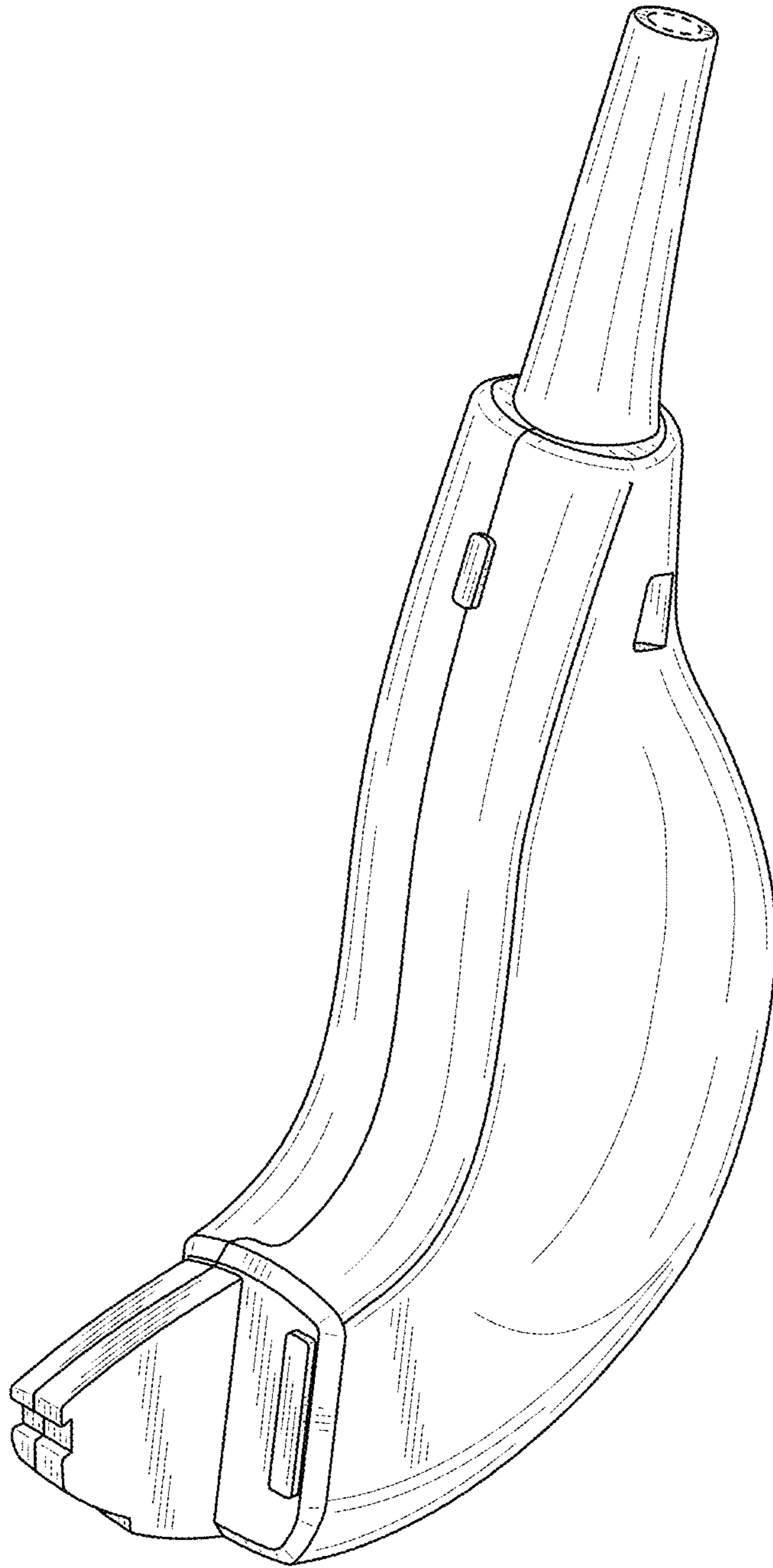

FIG.2

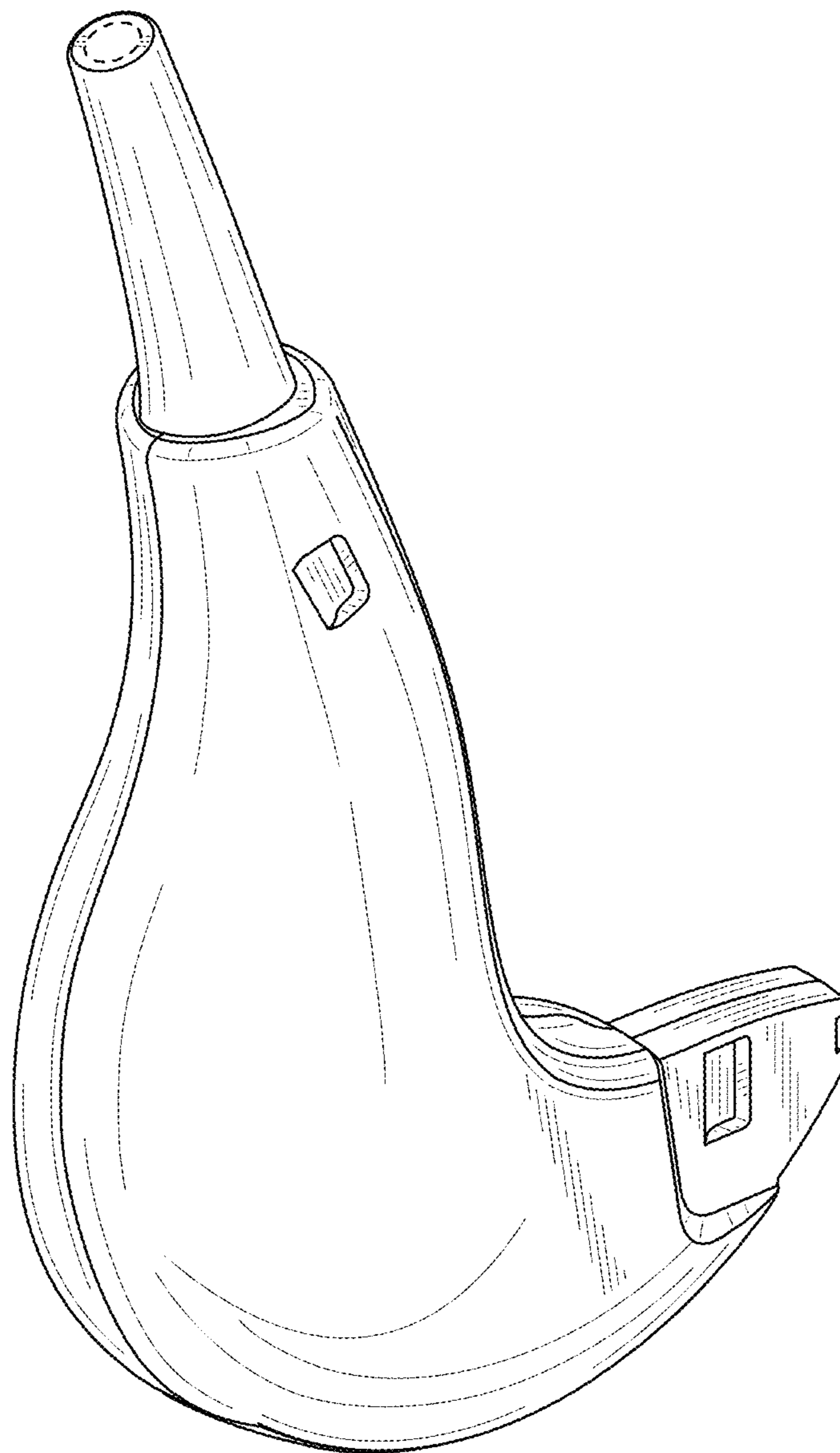

FIG.3

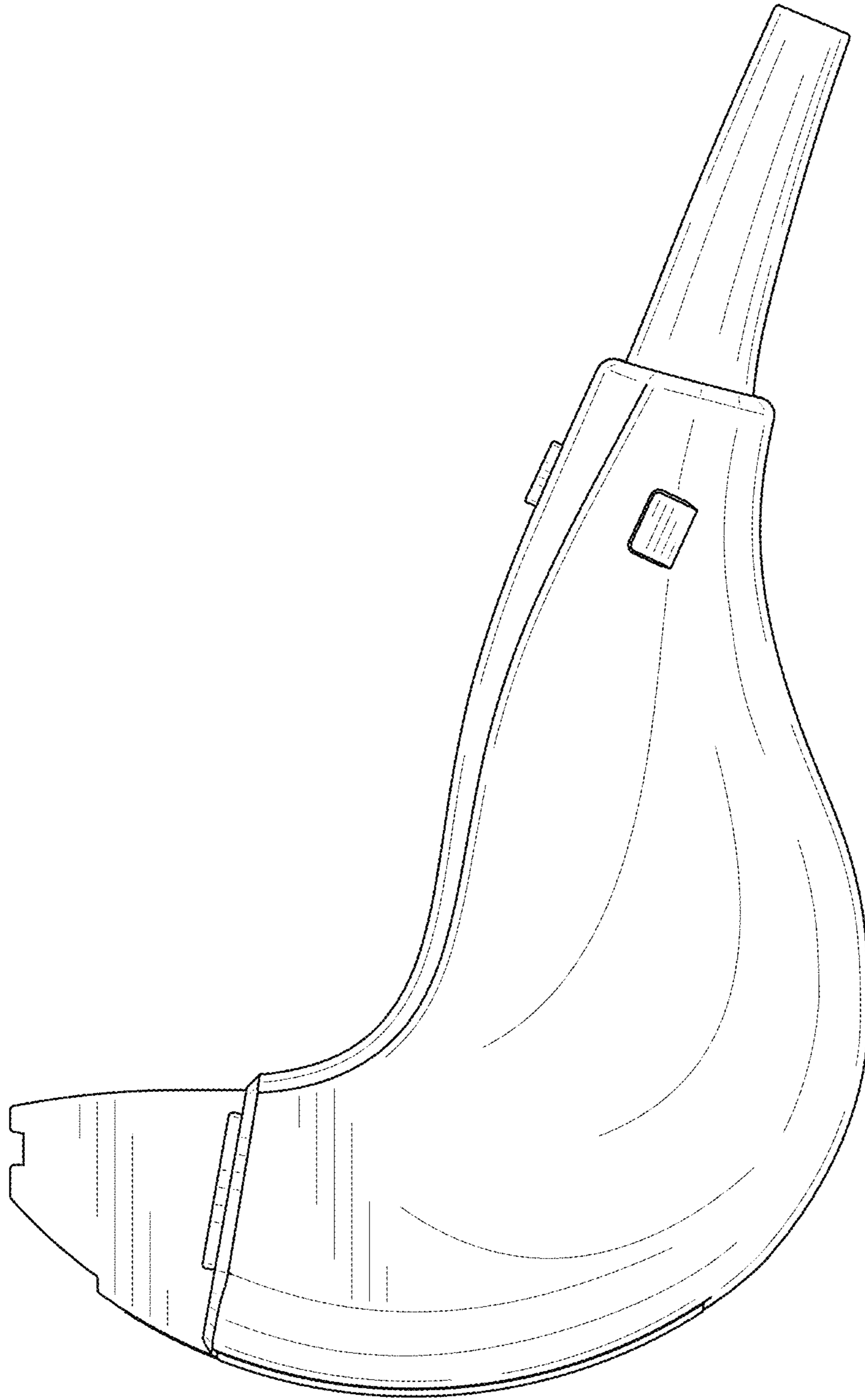

FIG.4

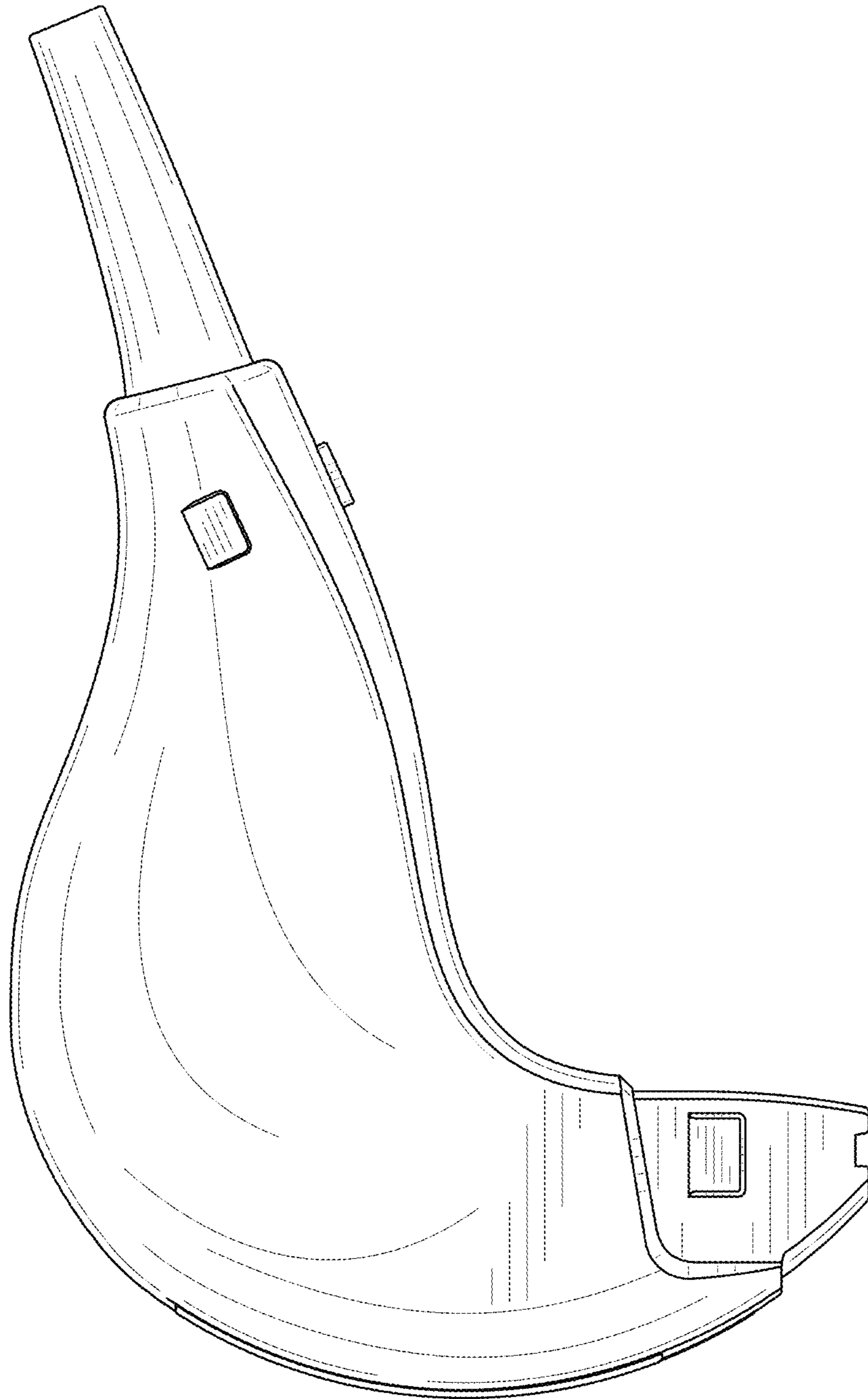

FIG.5

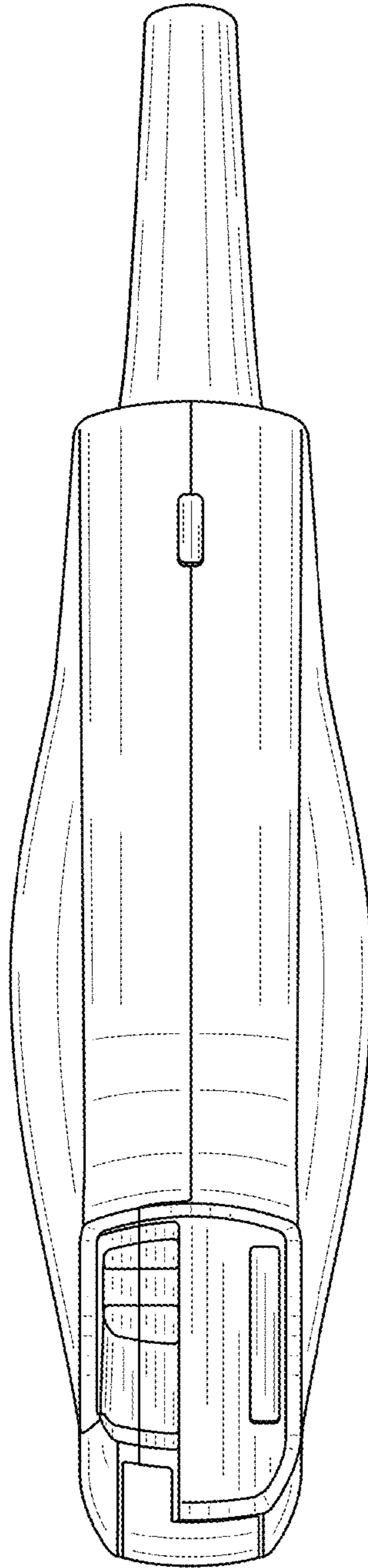

FIG. 6

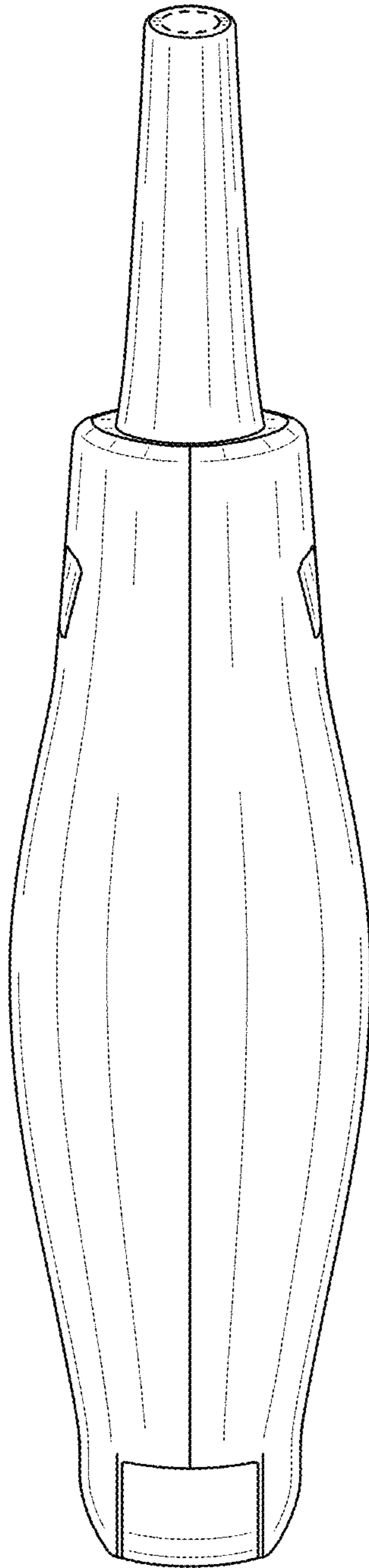

FIG.7

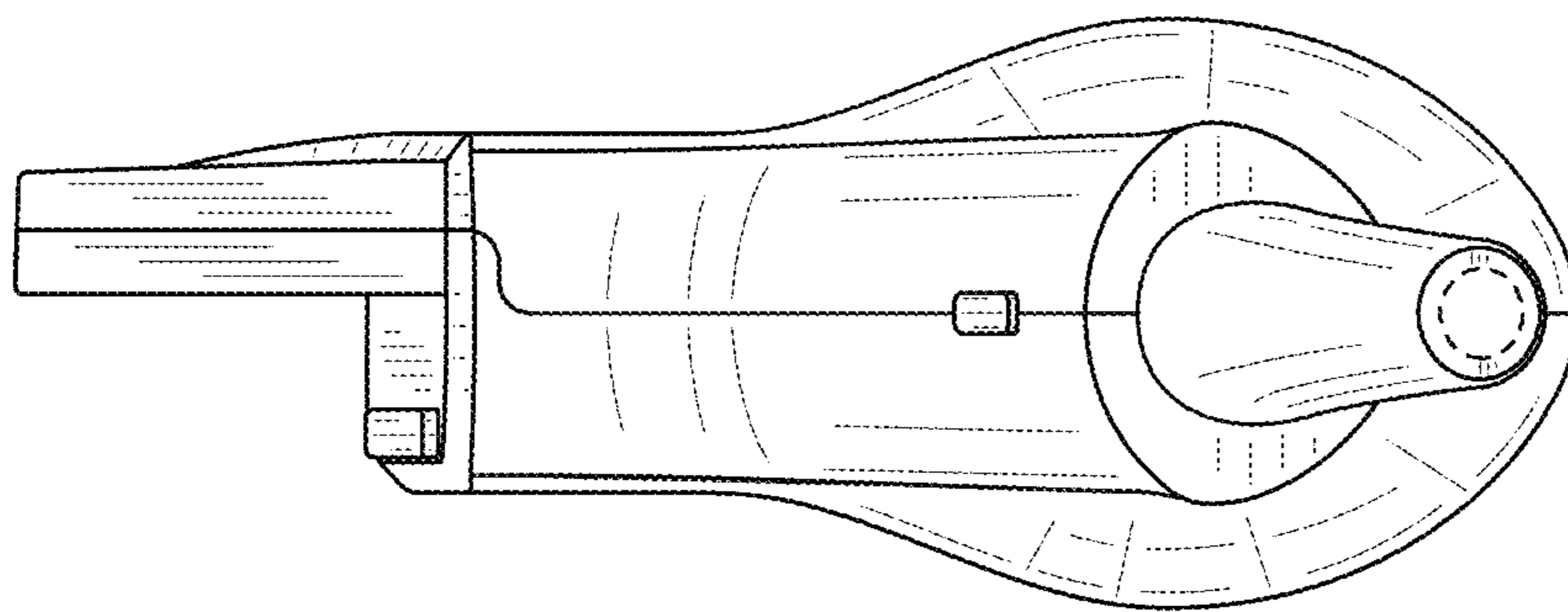

FIG.8

