



US00D702222S

(12) **United States Design Patent**
Kim

(10) **Patent No.:** **US D702,222 S**
(45) **Date of Patent:** **** Apr. 8, 2014**

(54) **CASE FOR PORTABLE ELECTRONIC DEVICE**

(71) Applicant: **Samsung Electronics Co., Ltd.**,
Suwon-si (KR)

(72) Inventor: **YoonYoung Kim**, Sunghnam-si (KR)

(73) Assignee: **Samsung Electronics Co., Ltd.**,
Suwon-si (KR)

(**) Term: **14 Years**

(21) Appl. No.: **29/453,918**

(22) Filed: **May 3, 2013**

Related U.S. Application Data

(63) Continuation of application No. 29/444,389, filed on
Jan. 30, 2013.

(30) **Foreign Application Priority Data**

Aug. 28, 2012 (KR) 30-2012-0041332

(51) **LOC (10) Cl.** **14-03**

(52) **U.S. Cl.**
USPC **D14/250**

(58) **Field of Classification Search**
USPC D14/250, 440, 238.1, 251-253,
D14/203.3-203.7, 217, 496, 248, 240, 447,
D14/341-347, 444; D13/103, 107-108,
D13/119; D3/201, 218, 247, 269, 273, 301,
D3/303; 248/309.1, 371, 176.3, 668;
361/679.56, 679.3, 679.25, 816;
379/433.11, 455; 455/575.1, 575.8;
206/305, 320; 320/108, 115; 429/96;
220/4.02; 150/165

See application file for complete search history.

(56) **References Cited**

U.S. PATENT DOCUMENTS

6,047,196 A 4/2000 Mäkelä et al.

(Continued)

FOREIGN PATENT DOCUMENTS

GB 2 391 740 A 2/2004

OTHER PUBLICATIONS

Review of Rock Elegant Side Flip Case for Samsung Galaxy Note II,
published on Mar 17, 2013, <URL:http://www.youtube.com/
watch?v=TAULRGa9syY>, retrieved from internet on May 13,
2013.*

(Continued)

Primary Examiner — Carla Jobe Wright

(74) *Attorney, Agent, or Firm* — NSIP Law

(57) **CLAIM**

The ornamental design for a case for portable electronic
device, as shown and described.

DESCRIPTION

FIG. 1 is a front perspective view of a case for portable
electronic device, showing my new design;
FIG. 2 is a front view thereof;
FIG. 3 is a rear view thereof;
FIG. 4 is a left-side view thereof;
FIG. 5 is a right-side view thereof;
FIG. 6 is a top plan view thereof;
FIG. 7 is a bottom plan view thereof; and,
FIG. 8 is an enlarged view of the encircled portion 8 as shown
in FIG. 6.

In FIGS. 6 and 8, the dot-dash broken line circle indicates the
portion of the case that is shown on an enlarged scale in FIG.
8. The other dot-dash broken lines, shown in FIGS. 1, 2, and
8, represent boundaries of the claimed design. All other broken
lines depict unclaimed environment. The broken lines
form no part of the claimed design.

1 Claim, 6 Drawing Sheets

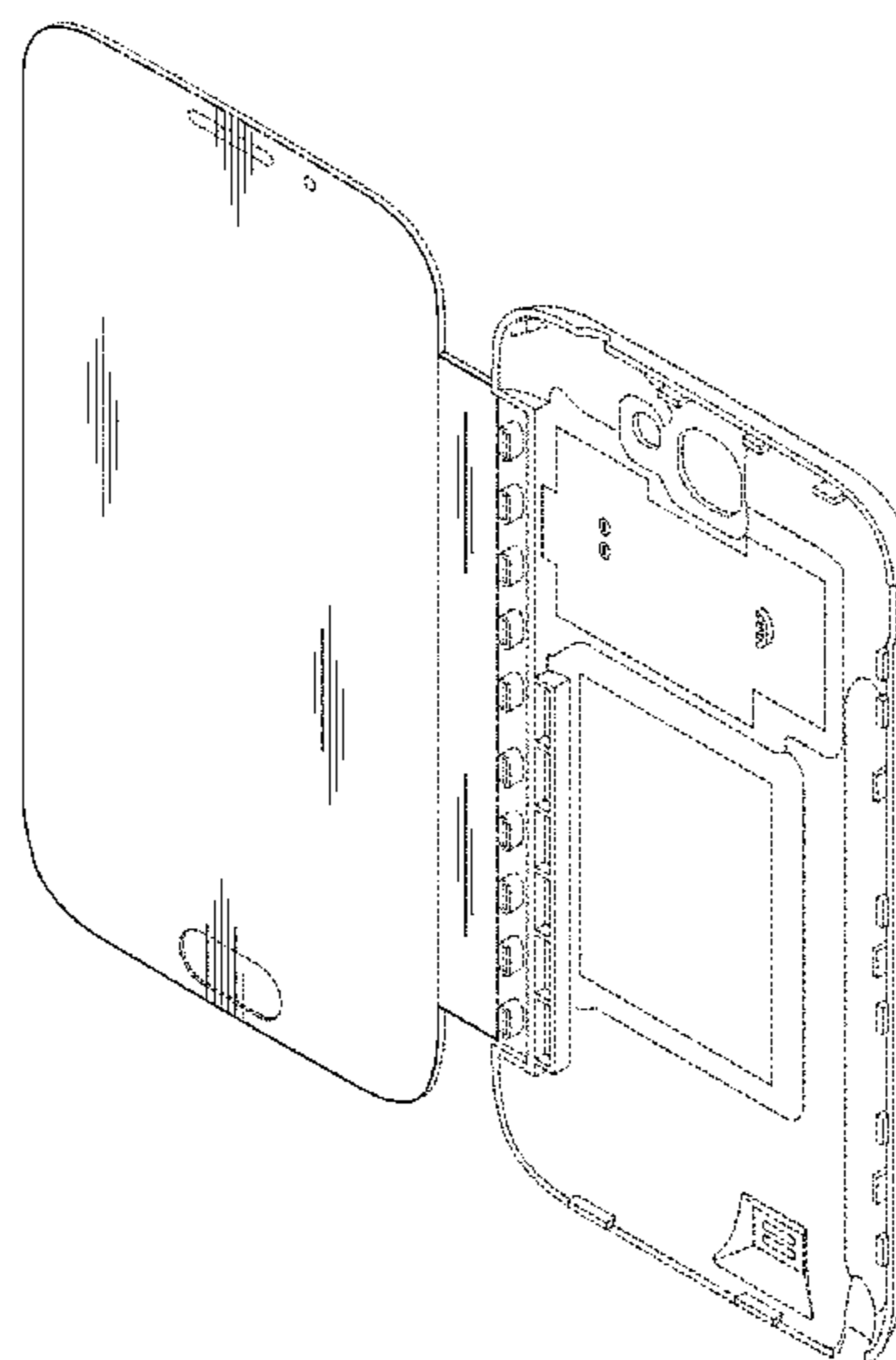

(56)

References Cited

U.S. PATENT DOCUMENTS

D433,808 S * 11/2000 Moorhouse, Sr. D3/303
 6,758,335 B2 * 7/2004 Kajiya 206/320
 6,968,056 B2 11/2005 Barnett et al.
 D519,559 S * 4/2006 Mehta D19/26
 7,251,323 B2 7/2007 Holtorf et al.
 D550,961 S * 9/2007 Eskandry D3/303
 7,383,067 B2 6/2008 Phillips et al.
 7,398,114 B2 7/2008 Gartrell
 D582,405 S * 12/2008 Andre et al. D3/299
 7,684,837 B2 3/2010 Ito
 D628,374 S * 12/2010 Lee et al. D3/201
 D641,348 S * 7/2011 Kim et al. D14/250
 8,005,522 B2 8/2011 Ou
 D645,836 S 9/2011 Choi et al.
 D648,529 S * 11/2011 Brown D3/269
 8,078,223 B2 12/2011 An et al.
 D652,829 S * 1/2012 Kim et al. D14/250
 8,134,829 B2 3/2012 Clark et al.
 D657,354 S * 4/2012 Kim D14/250
 RE43,370 E 5/2012 Mäkelä et al.
 D669,121 S * 10/2012 May D19/26
 D669,270 S * 10/2012 Phillips et al. D3/301
 D674,799 S * 1/2013 Kim D14/440
 D678,260 S * 3/2013 Bau D14/250

D679,270 S * 4/2013 Eicher D14/250
 2009/0314400 A1 * 12/2009 Liu 150/165
 2011/0290687 A1 * 12/2011 Han 206/320
 2012/0178507 A1 * 7/2012 Lee 455/575.1
 2012/0305424 A1 * 12/2012 Sogabe et al. 206/320
 2012/0322518 A1 * 12/2012 Kim 455/575.8
 2013/0015088 A1 * 1/2013 Wu 206/320
 2013/0020214 A1 * 1/2013 Chiou 206/320
 2013/0020215 A1 * 1/2013 Hsu 206/320

OTHER PUBLICATIONS

Rock Elegant Side Flip Protective Leather Case for Samsung Galaxy Note 2, <URL:<http://www.tvc-mall.com/details/ROCK-Elegant-Side-Flip-Protective-Leather-Case-for-Samsung-Galaxy-Note-2-II-N7100-MLC-N7100-81/>>, retrieved from internet on May 13, 2013.*

Androidizen review of Belkin Snap Folio Case for Samsung Galaxy Note 2, published on Jan 13, 2013, <URL:<http://www.youtube.com/watch?v=C52zLHKQSBw>>, retrieved from internet on May 13, 2013.*

U.S. Appl. No. 29/444,389, filed Jan. 30, 2013, YoonYoung Kim, Samsung Electronics Co., Ltd.

U.S. Appl. No. 2/453,899, filed May 3, 2013, YoonYoung Kim, Samsung Electronics Co., Ltd.

* cited by examiner

FIG.1

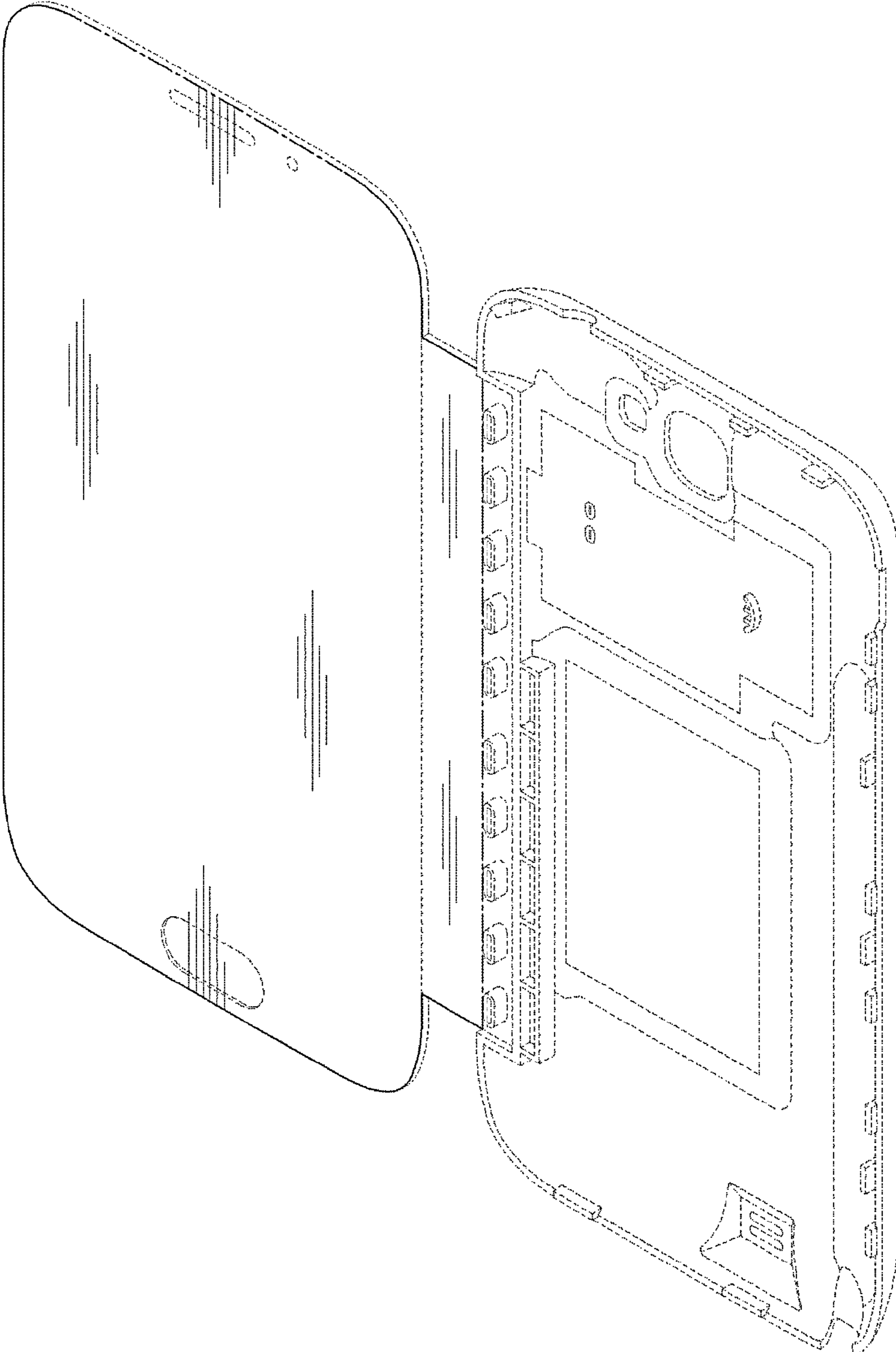

FIG.2

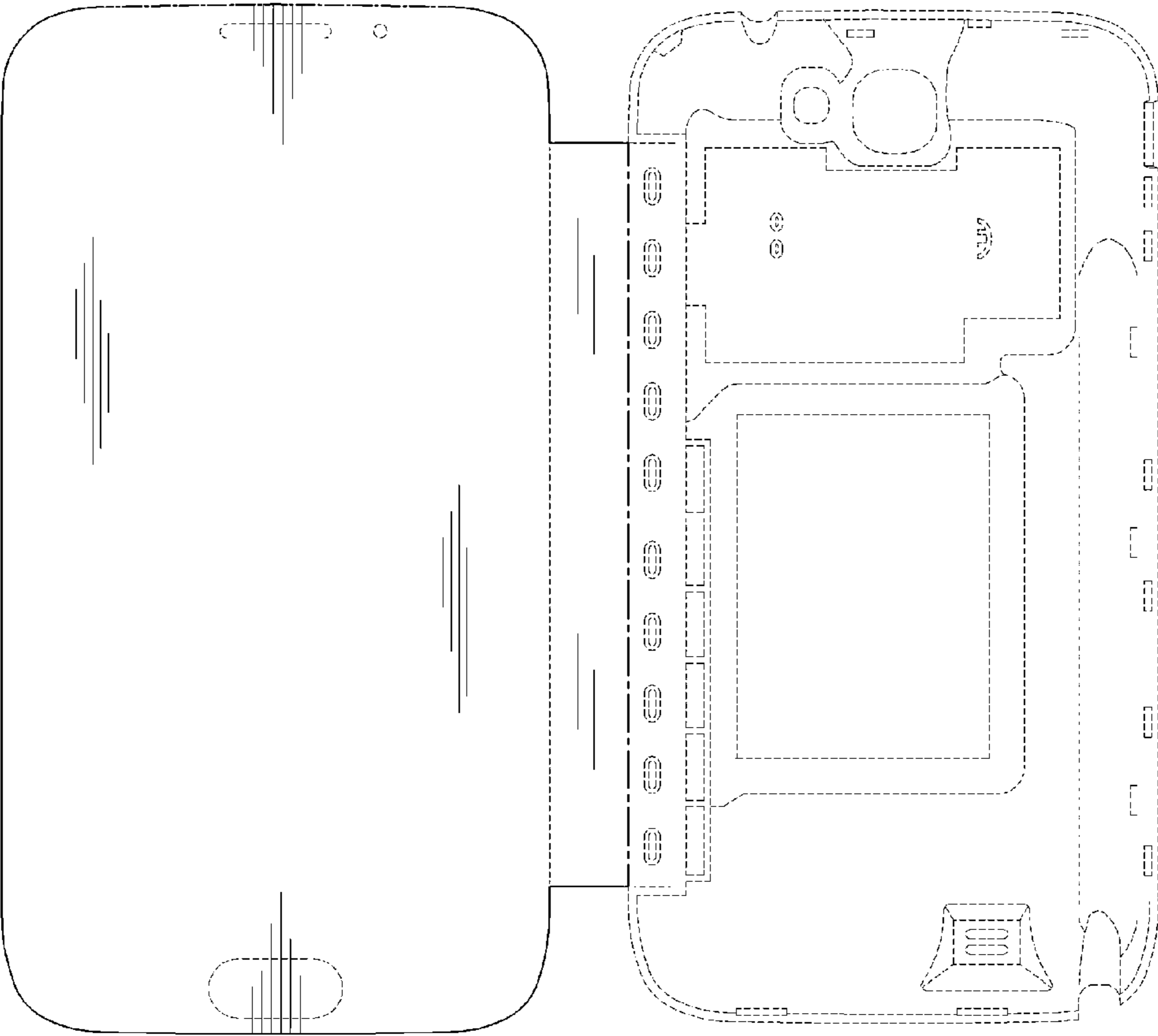

FIG. 3

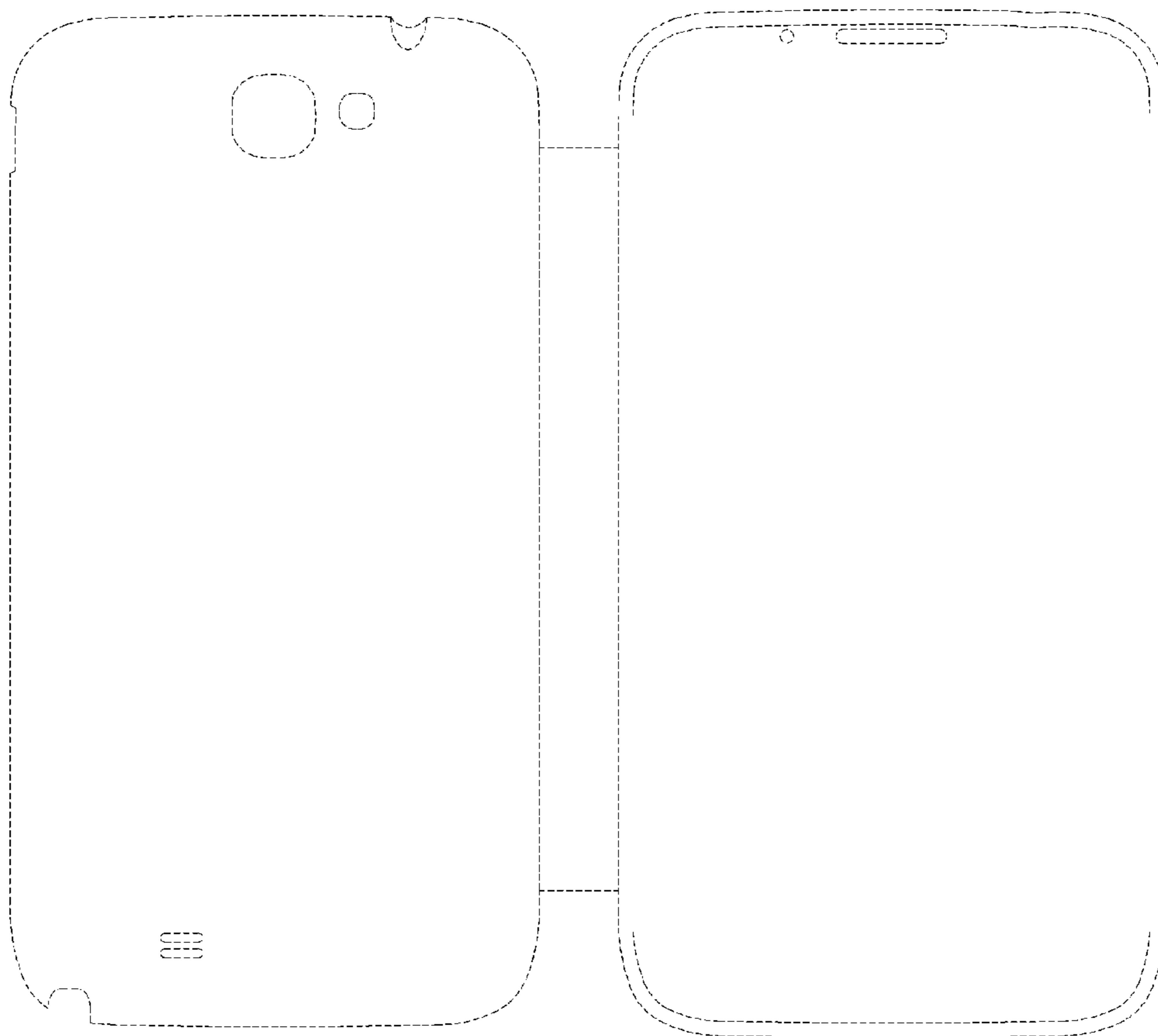

FIG.4

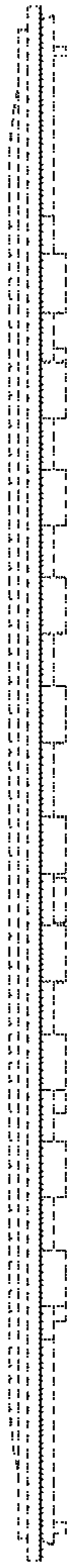

FIG. 5

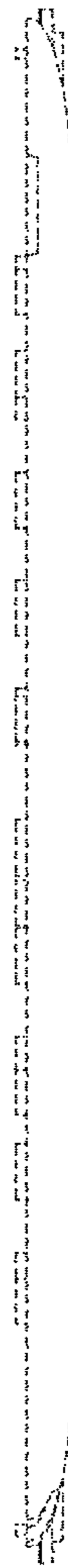

FIG.6

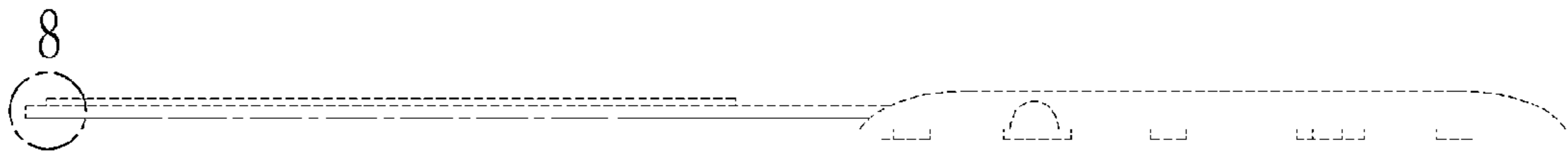

FIG.7



FIG.8

