



US00D702135S

(12) **United States Design Patent**
Loth et al.

(10) **Patent No.:** **US D702,135 S**
(45) **Date of Patent:** **** Apr. 8, 2014**

(54) **WRISTWATCH**

(71) Applicant: **Graham SA**, La Chaux-de-Fonds (CH)

(72) Inventors: **Eric Loth**, Bienne (CH); **Christophe Robert**, Le Locle (CH); **Julien Bernard**, La Neuveville (CH)

(73) Assignee: **Graham SA**, La Chaux-de-Fonds (CH)

(**) Term: **14 Years**

(21) Appl. No.: **29/465,445**

(22) Filed: **Aug. 28, 2013**

(30) **Foreign Application Priority Data**

Apr. 25, 2013 (CH) 139866

(51) **LOC (10) Cl.** **10-02**

(52) **U.S. Cl.**
USPC **D10/32; D10/36**

(58) **Field of Classification Search**
USPC D10/30-39; 368/276, 281, 282, 223,
368/228, 80, 232, 15-18; D11/3
See application file for complete search history.

(56) **References Cited**

U.S. PATENT DOCUMENTS

D244,587 S * 6/1977 Molyneux et al. D10/125
4,766,579 A * 8/1988 Sporning 368/190
D303,504 S * 9/1989 Hysek D10/32
D326,823 S * 6/1992 Wunderman D10/32
D360,141 S * 7/1995 Scheufele D10/32

D452,175 S * 12/2001 Finazzi D10/39
D460,002 S * 7/2002 Wunderman D10/32
D473,471 S * 4/2003 Rufenacht D10/32
D473,473 S * 4/2003 Wunderman D10/32
D526,218 S * 8/2006 Krieger D10/39
7,170,824 B2 * 1/2007 Wilmouth et al. 368/18
D563,802 S * 3/2008 Loth D10/39
D574,263 S * 8/2008 Loth D10/38
D574,734 S * 8/2008 Loth D10/38
D585,768 S * 2/2009 Loth D10/39
D586,238 S * 2/2009 Loth D10/32
7,773,462 B2 * 8/2010 Vuilleumier et al. 368/18
D650,296 S * 12/2011 Laucella D10/39
D680,883 S * 4/2013 Loth et al. D10/32
D687,723 S * 8/2013 Galli D10/39

* cited by examiner

Primary Examiner — Lucy Lieberman

(74) *Attorney, Agent, or Firm* — Sughrue Mion, PLLC

(57) **CLAIM**

The ornamental design for a wristwatch, as shown and described.

DESCRIPTION

FIG. 1 is a front perspective view of my new design for a wristwatch;
FIG. 2 is a rear perspective view thereof;
FIG. 3 is a front view thereof;
FIG. 4 is a back view thereof;
FIG. 5 is a left side view thereof;
FIG. 6 is a right side view thereof;
FIG. 7 is a top view thereof; and,
FIG. 8 is a bottom view thereof.

1 Claim, 8 Drawing Sheets

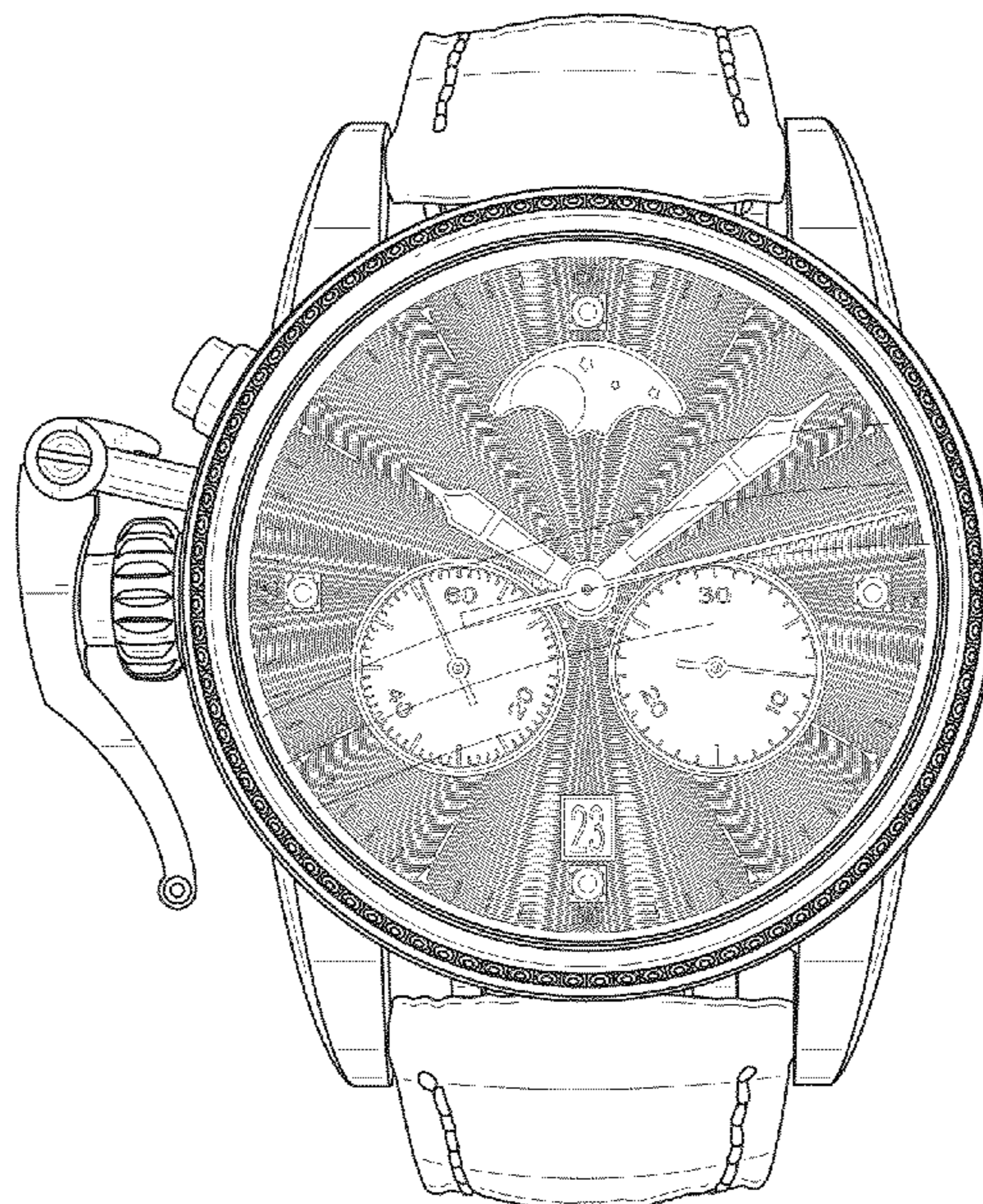

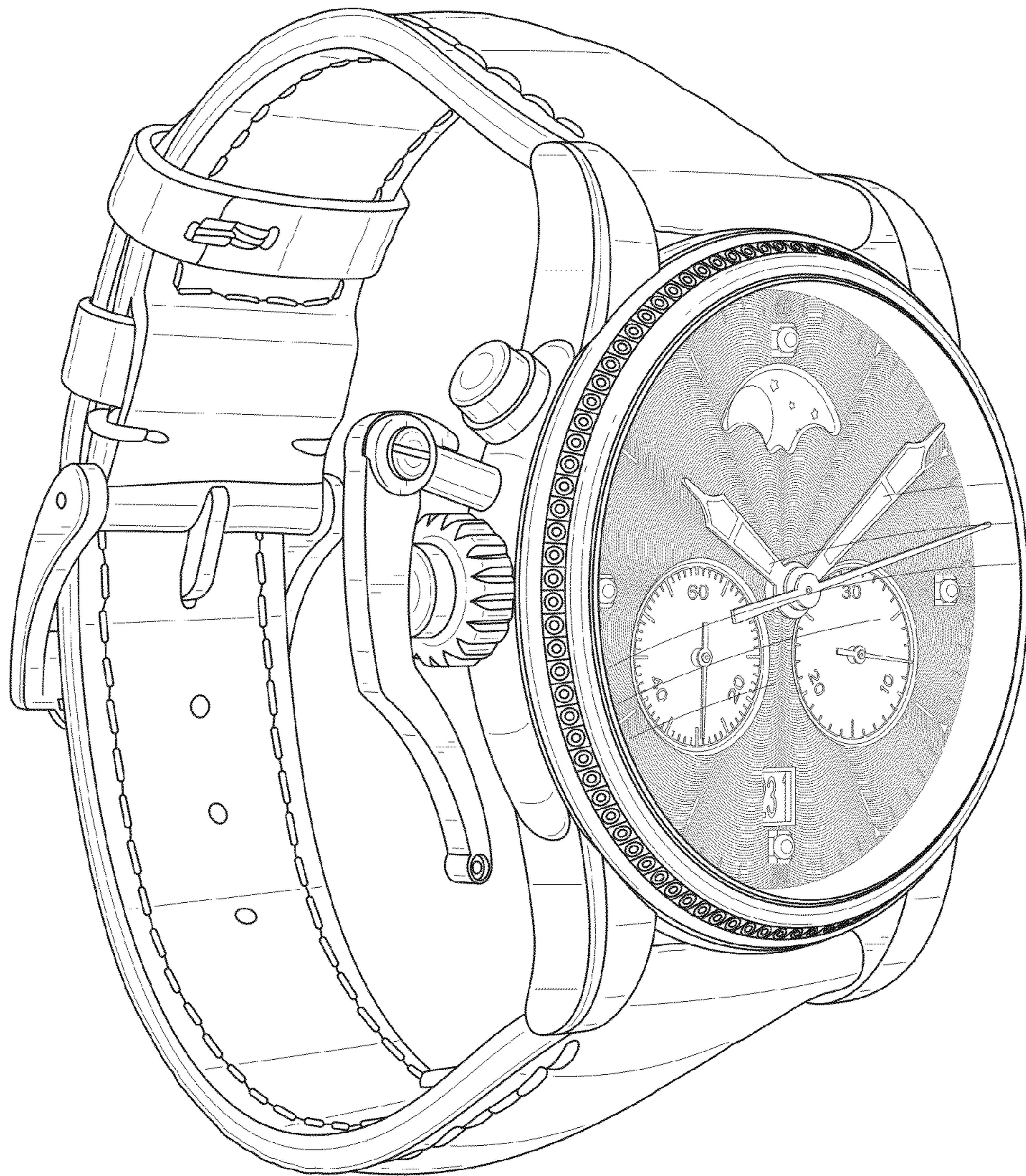

FIG. 1

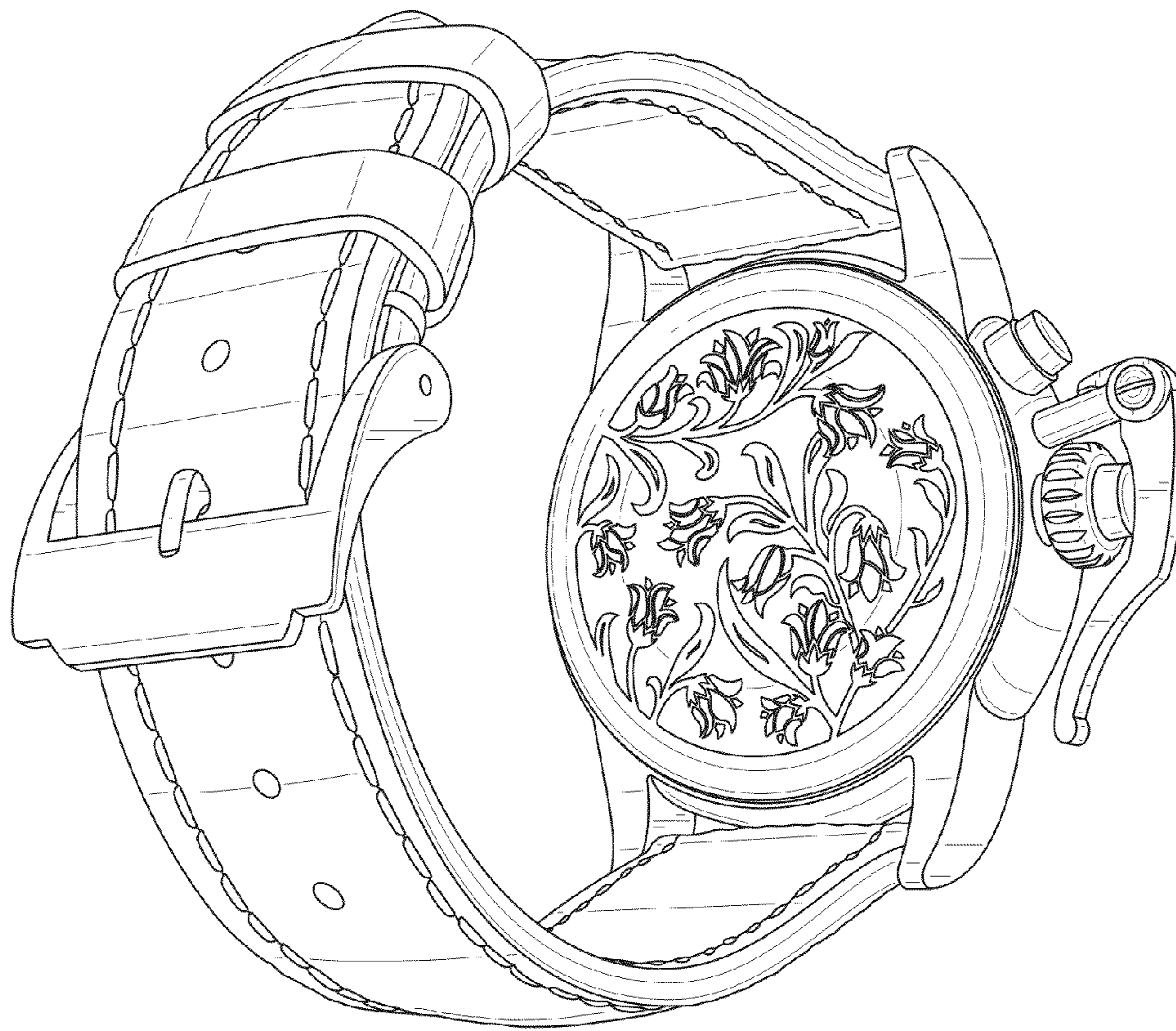

FIG. 2



FIG. 3

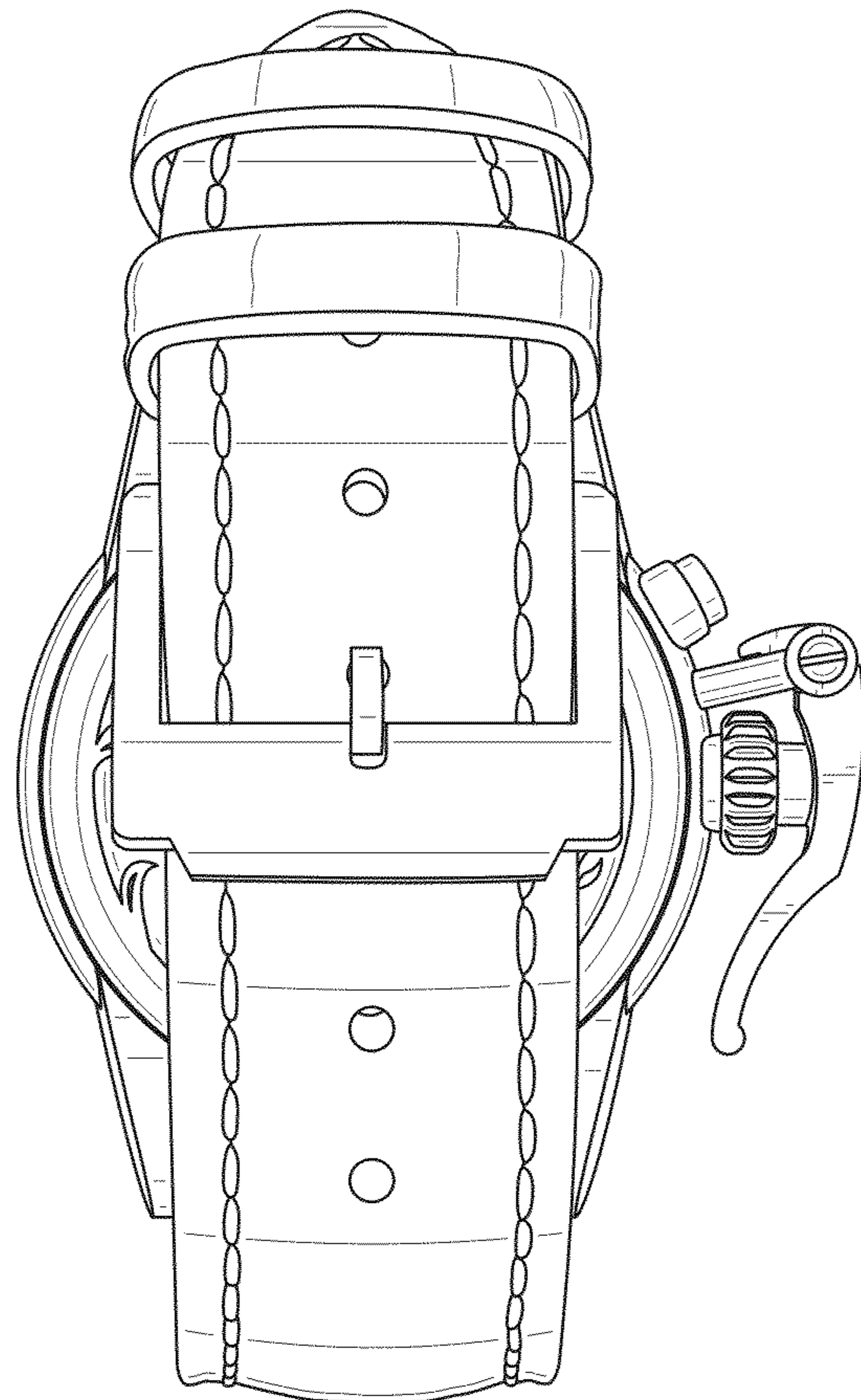

FIG. 4

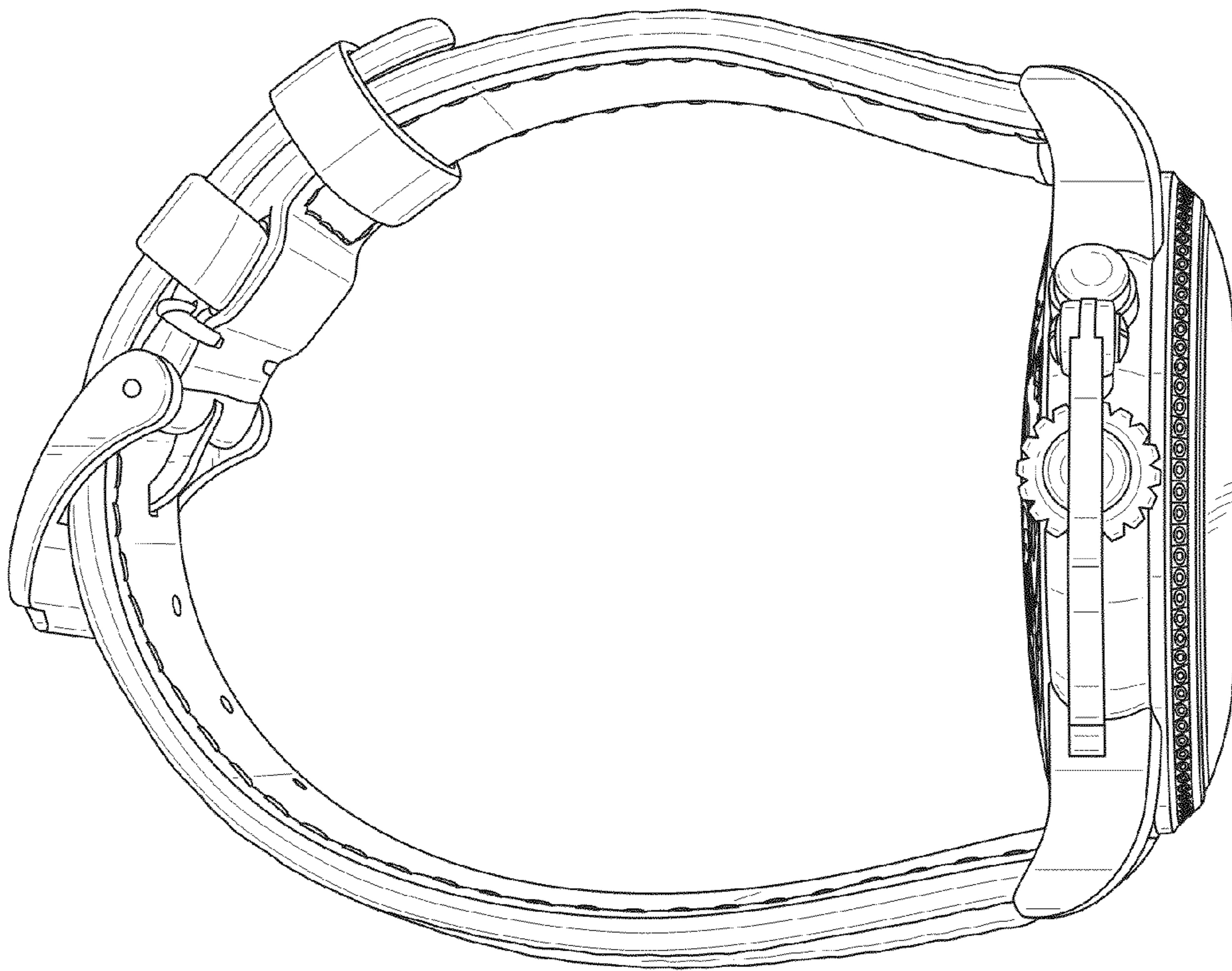

FIG. 5

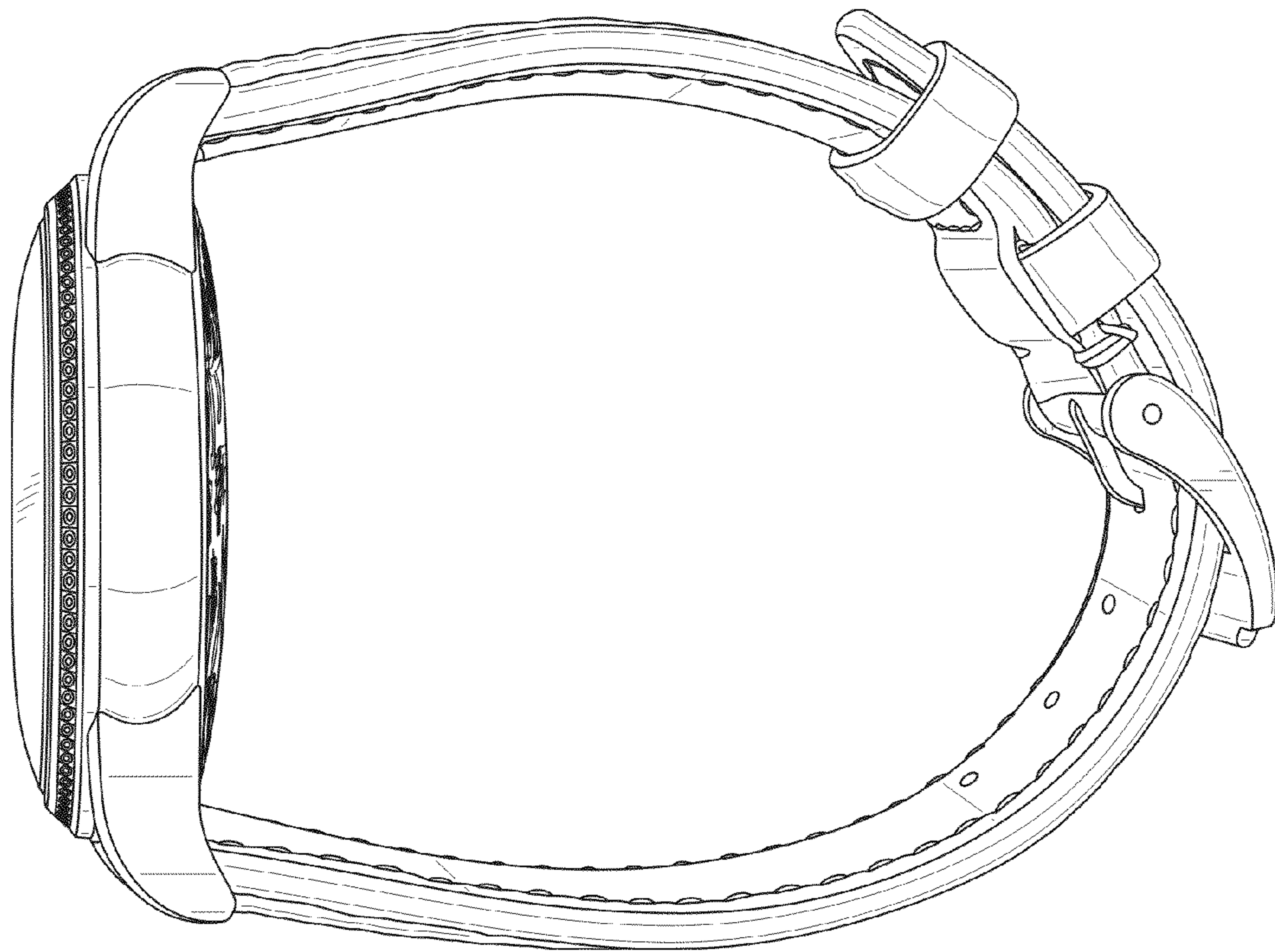

FIG. 6

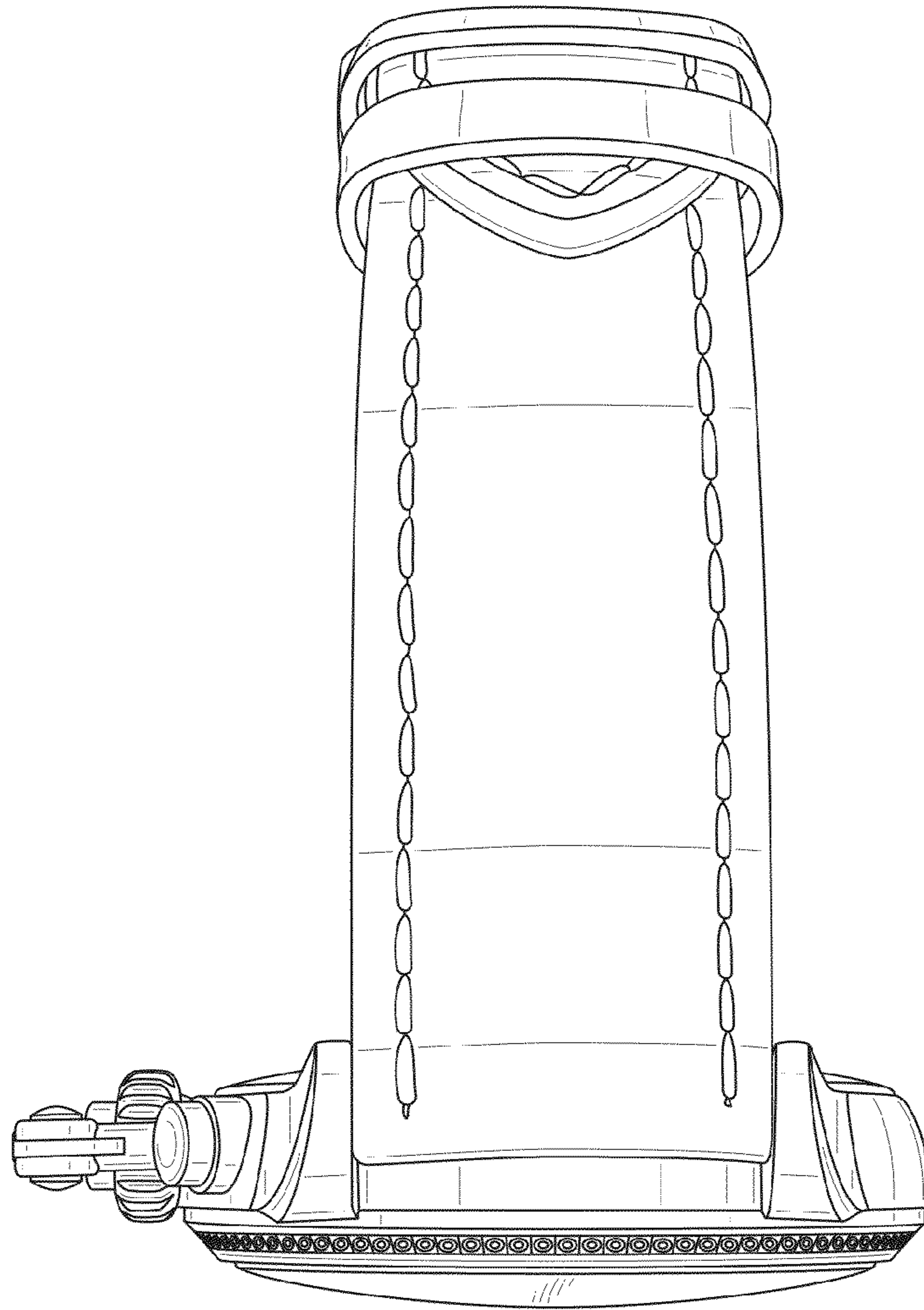

FIG. 7

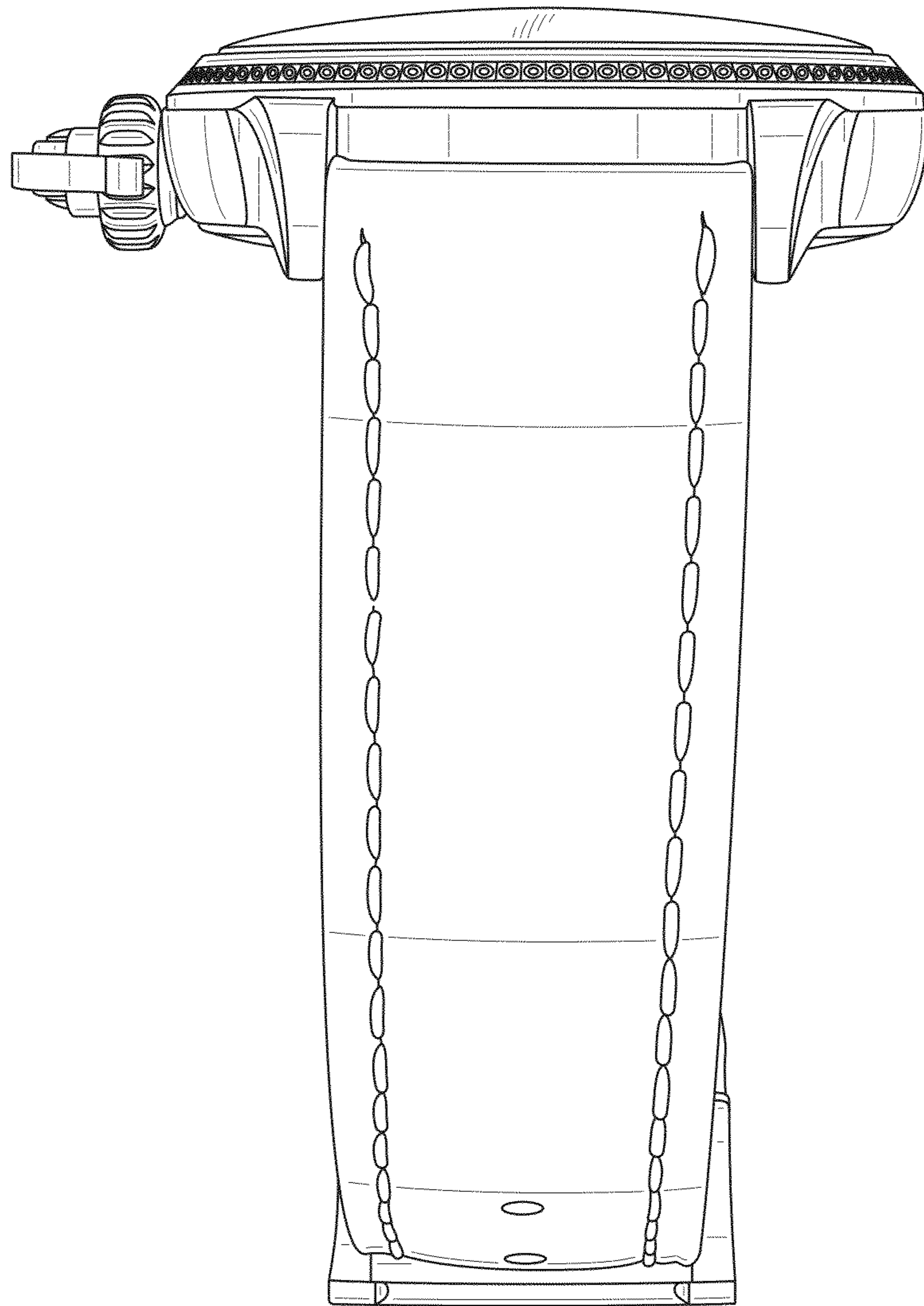

FIG. 8