

US00D701992S

(12) **United States Design Patent**  
**von Zittwitz**

(10) **Patent No.:** **US D701,992 S**  
(45) **Date of Patent:** **\*\* Apr. 1, 2014**

- (54) **COVER FOR A LIGHTING UNIT**
- (71) Applicant: **ZON LED LLC**, Romeo, MI (US)
- (72) Inventor: **Paul von Zittwitz**, Romeo, MI (US)
- (73) Assignee: **Zon Led LLC**, Romeo, MI (US)
- (\*\*) Term: **14 Years**
- (21) Appl. No.: **29/453,635**
- (22) Filed: **May 1, 2013**
- (51) **LOC (10) Cl.** ..... **26-99**
- (52) **U.S. Cl.**  
USPC ..... **D26/118**
- (58) **Field of Classification Search**  
USPC ..... D26/152, 113, 118, 119, 154, 61, 62,  
D26/65, 75, 16, 1, 2, 3, 120, 138, 128, 155,  
D26/76, 121, 124, 125, 123, 141, 142, 66,  
D26/68, 86, 71, 72, 77, 78, 151, 145, 74, 85,  
D26/89, 82, 84, 92, 87, 136, 63, 59, 58, 28,  
D26/88, 11, 9, 22, 81, 127, 129, 130, 131,  
D26/133, 134, 135, 55; D13/179, 180;  
362/219, 223, 225, 347, 346, 373, 326,  
362/283, 249.02, 362, 374, 375, 408, 327,  
362/328, 404, 297, 147, 149, 249.03,  
362/249.11; D23/377, 411, 413; D11/89,  
D11/90  
See application file for complete search history.

- (56) **References Cited**  
U.S. PATENT DOCUMENTS  
5,075,827 A \* 12/1991 Smith ..... 362/221  
5,142,459 A \* 8/1992 Swarens et al. .... 362/147  
D344,359 S \* 2/1994 Matos ..... D26/93  
D351,481 S \* 10/1994 Cole, Jr. .... D26/76  
D356,876 S \* 3/1995 Waldmann ..... D26/107  
6,079,851 A \* 6/2000 Altman et al. .... 362/260

- D447,272 S \* 8/2001 Smith ..... D26/118
- 6,454,442 B1 \* 9/2002 Changaris ..... 362/297
- 6,508,574 B1 \* 1/2003 Sara et al. .... 362/297
- D485,636 S \* 1/2004 Patterson et al. .... D26/92
- 6,773,135 B1 \* 8/2004 Packer ..... 362/145
- 6,918,684 B2 \* 7/2005 Harvey ..... 362/297
- 7,175,312 B2 \* 2/2007 Fowler, Jr. .... 362/260
- D544,138 S \* 6/2007 Hargreaves ..... D26/118
- D565,222 S \* 3/2008 Dixon ..... D26/63
- D575,139 S \* 8/2008 LePoire et al. .... D8/349
- D585,587 S \* 1/2009 Fan ..... D26/118
- D606,701 S \* 12/2009 Chandler ..... D26/87
- D623,344 S \* 9/2010 Tsai ..... D26/138
- D623,350 S \* 9/2010 Tsai ..... D26/140
- D626,271 S \* 10/2010 Verelst ..... D26/85
- D646,014 S \* 9/2011 Hsieh ..... D26/118
- D659,895 S \* 5/2012 Maxik et al. .... D26/118

(Continued)

*Primary Examiner* — Kevin Rudzinski  
(74) *Attorney, Agent, or Firm* — Endurance Law Group, PLC

(57) **CLAIM**  
I claim the ornamental design for a cover for a lighting unit, as shown and described.

**DESCRIPTION**

FIG. 1 is a perspective view of a cover for an overhead-type lighting unit;  
FIG. 2 is another perspective view of the cover;  
FIG. 3 is top view of the decorative cover;  
FIG. 4 is a front view of the decorative cover, the rear view being a mirror image thereof;  
FIG. 5 is a right end view as taken from FIG. 4;  
FIG. 6 is a left end view as taken from FIG. 4; and,  
FIG. 7 is a bottom view.  
The broken lines are directed to environment and are for illustrative purposes only; the broken lines form no part of the claimed design.

**1 Claim, 6 Drawing Sheets**

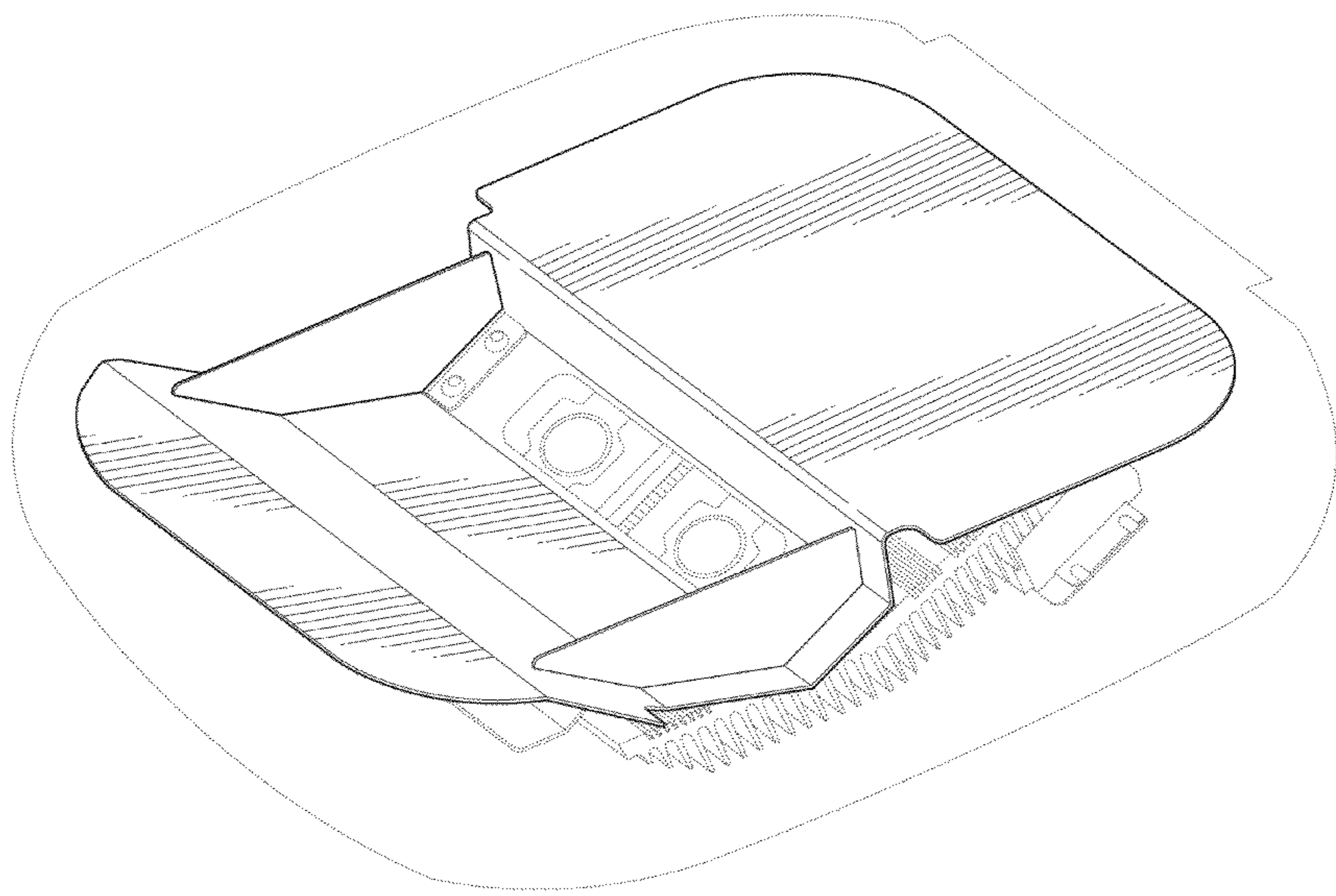

# US D701,992 S

Page 2

---

(56)

## References Cited

2004/0037068 A1\* 2/2004 Patterson et al. .... 362/147  
2005/0018428 A1\* 1/2005 Harvey ..... 362/297

## U.S. PATENT DOCUMENTS

D673,719 S \* 1/2013 Yeh ..... D26/118 \* cited by examiner

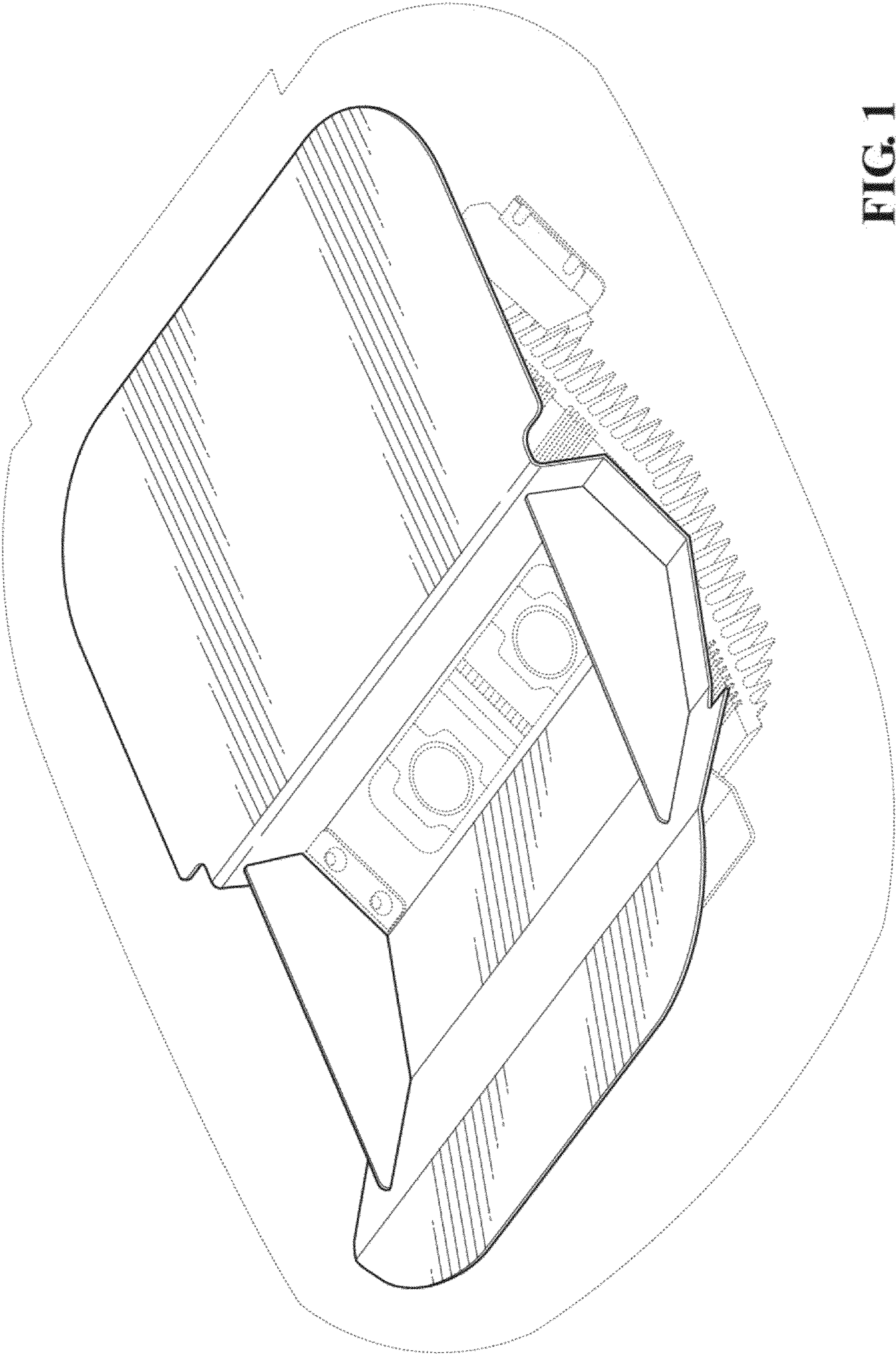

FIG. 1

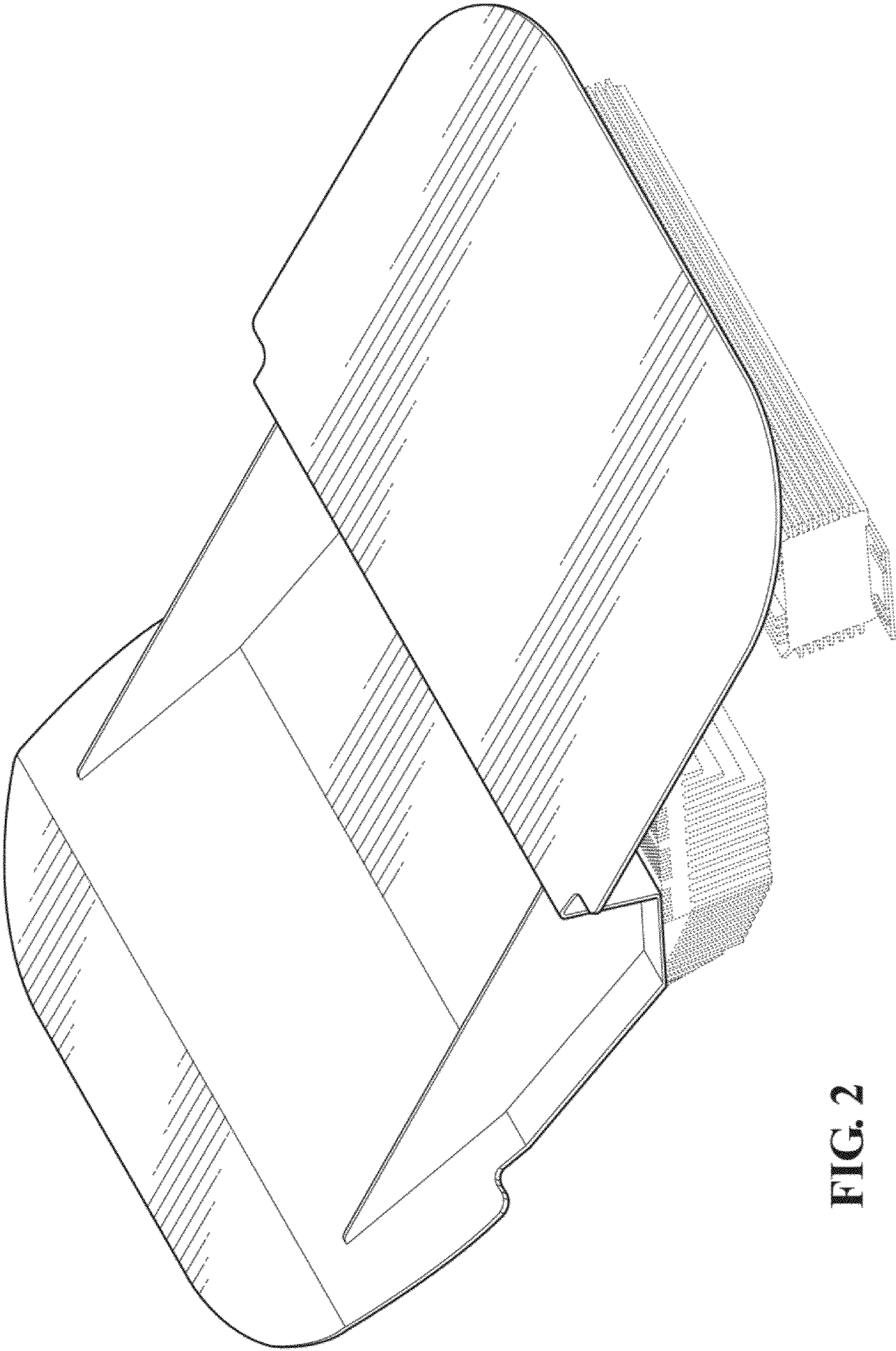

FIG. 2

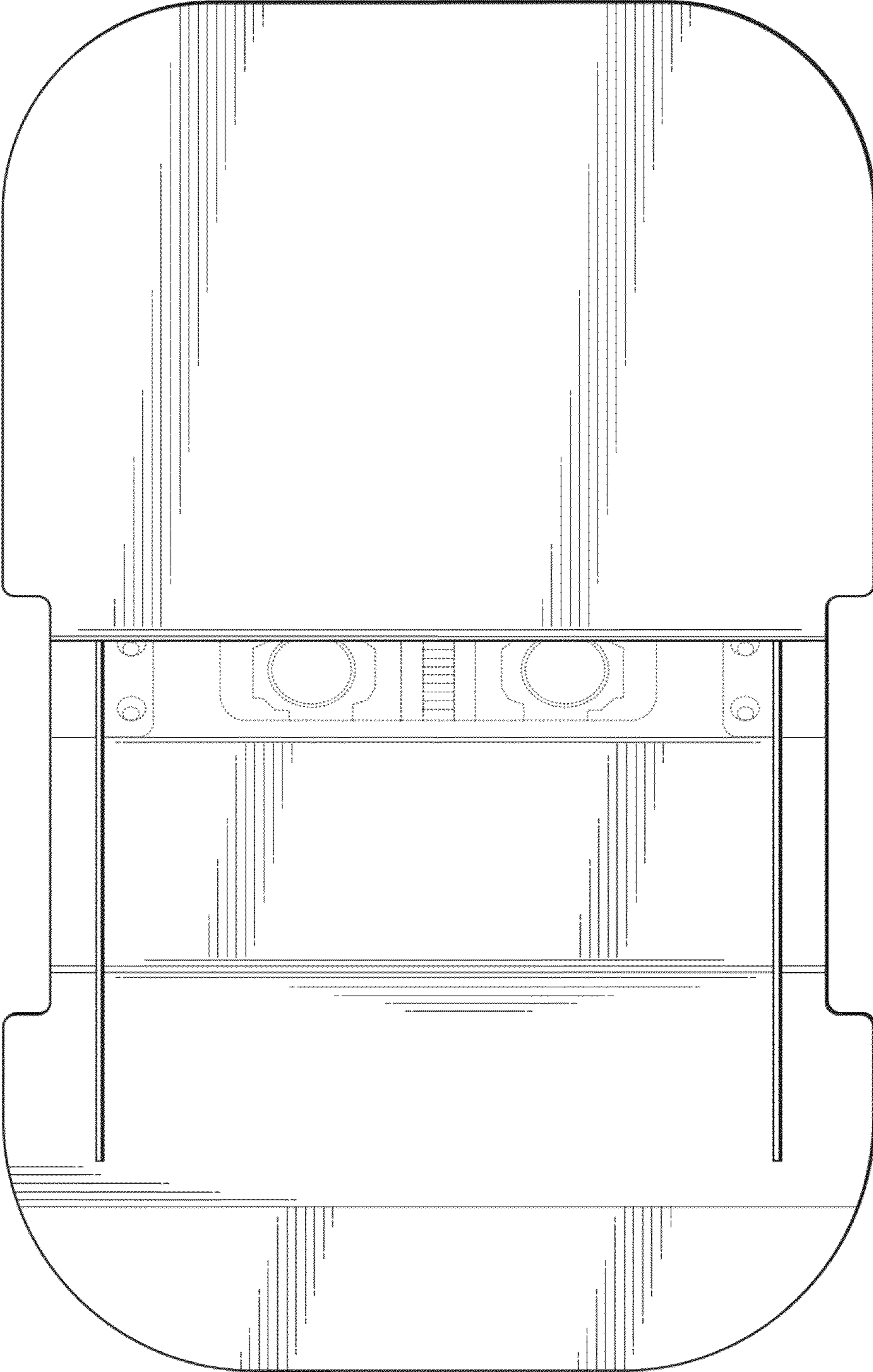

FIG. 3

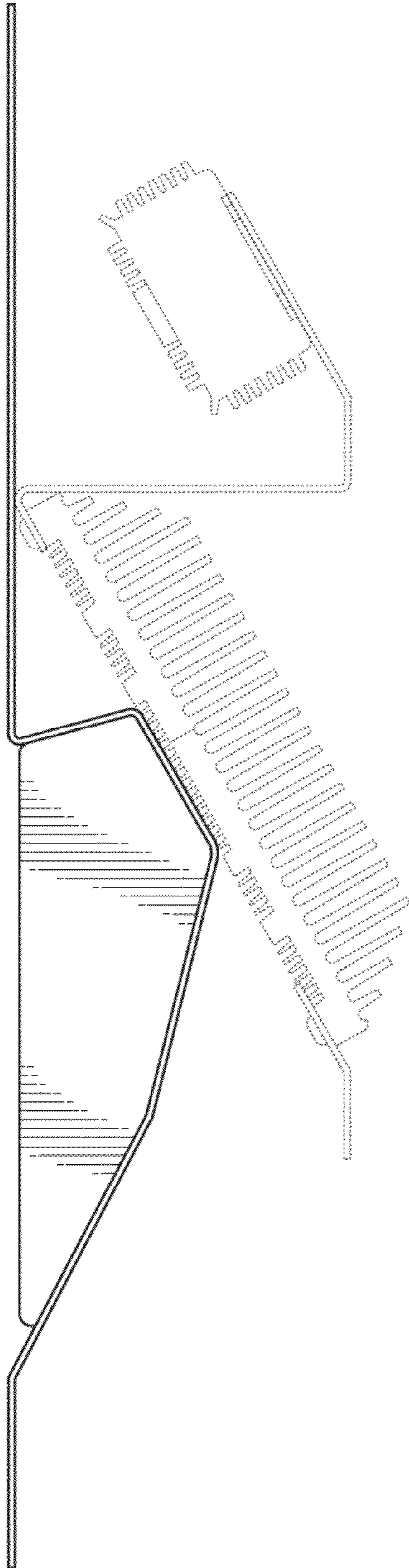

FIG. 4

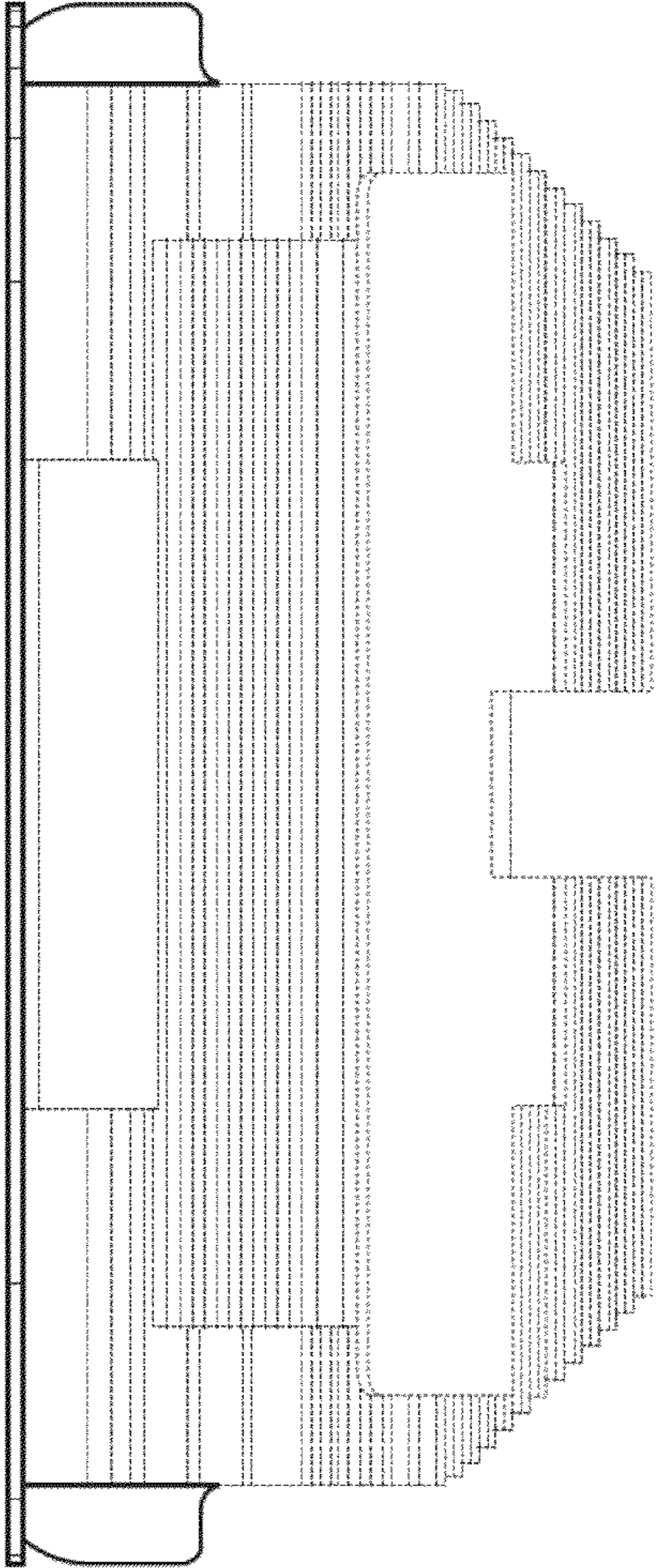

FIG. 5

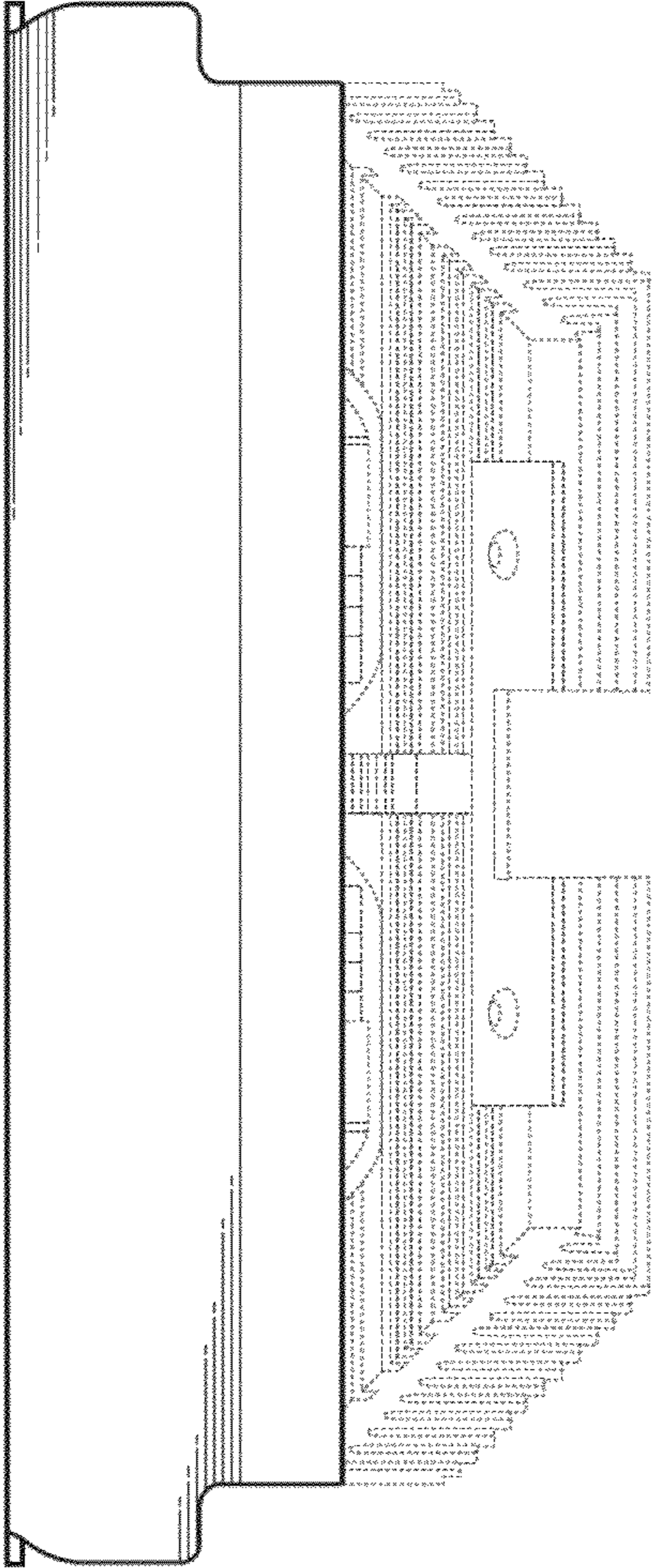

FIG. 6

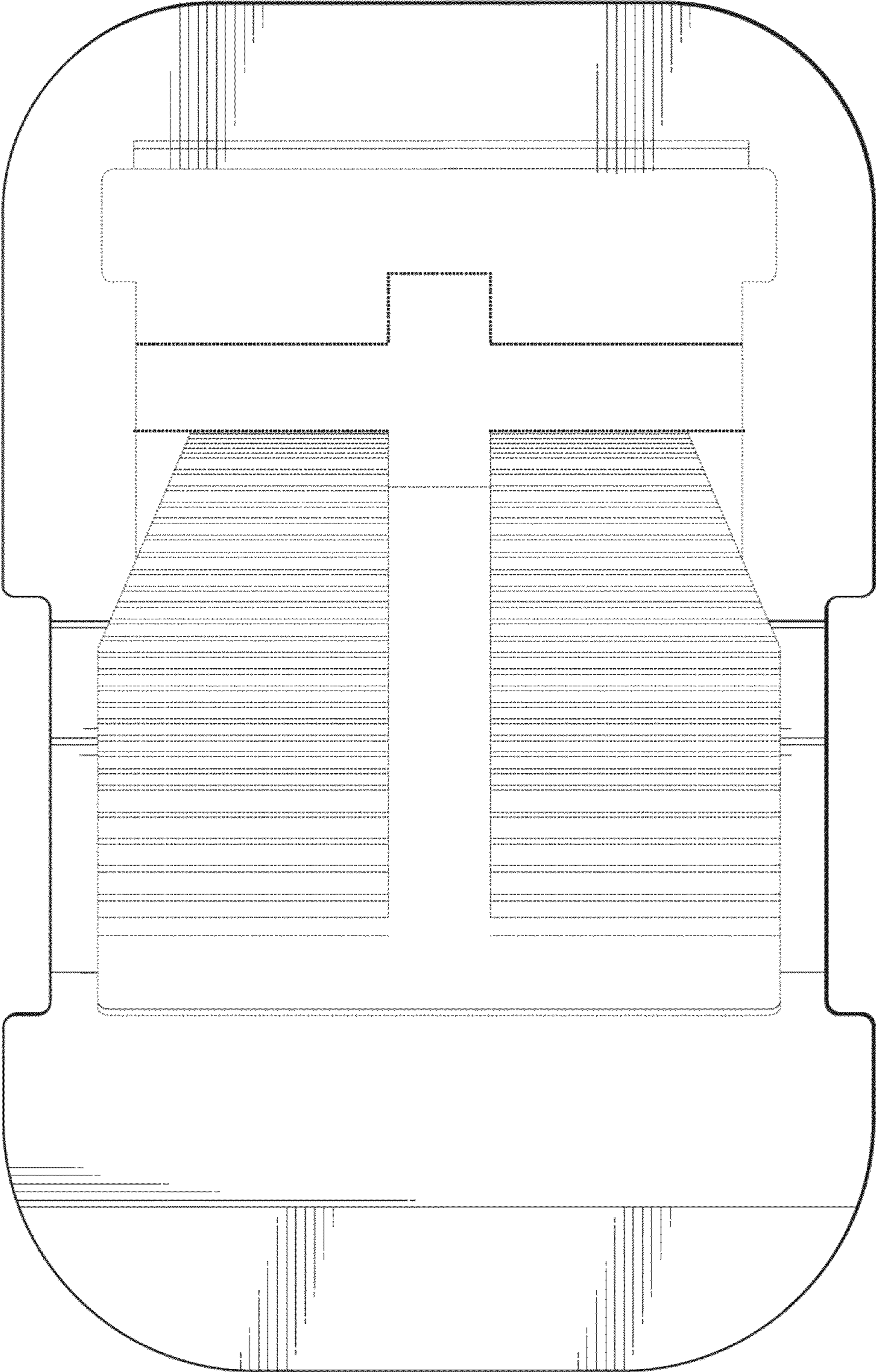

FIG. 7