



US00D701985S

(12) **United States Design Patent**
Wu

(10) **Patent No.:** **US D701,985 S**

(45) **Date of Patent:** **** Apr. 1, 2014**

(54) **VEHICLE HEADLIGHT LENS**

(56) **References Cited**

(71) Applicant: **Coplus Inc.**, Tainan (TW)

U.S. PATENT DOCUMENTS

(72) Inventor: **Hua-Chi Wu**, Tainan (TW)

D528,681 S *	9/2006	Nakahara	D26/28
D528,685 S *	9/2006	Yoshida	D26/28
D544,114 S *	6/2007	Ohta	D26/28
D544,614 S *	6/2007	Markefka	D26/28
D549,857 S *	8/2007	Lin	D26/28
D561,358 S *	2/2008	Tachibana	D26/28

(73) Assignee: **Coplus Inc.**, Tainan (TW)

* cited by examiner

(**) Term: **14 Years**

Primary Examiner — Marcus Jackson

(21) Appl. No.: **29/452,437**

(74) *Attorney, Agent, or Firm* — Christie, Parker & Hale, LLP

(22) Filed: **Apr. 16, 2013**

(57) **CLAIM**

The ornamental design for a vehicle headlight lens, as shown and described.

(30) **Foreign Application Priority Data**

DESCRIPTION

Jan. 30, 2013 (TW) 102300825

(51) **LOC (10) Cl.** **26-06**

(52) **U.S. Cl.**

USPC **D26/28**

(58) **Field of Classification Search**

USPC D26/28-36, 119; 362/459-468,
362/475-478, 485-487

FIG. 1 is a front perspective view of the vehicle headlight lens;

FIG. 2 is a front view thereof;

FIG. 3 is a rear view thereof;

FIG. 4 is a left side view thereof;

FIG. 5 is a right side view thereof;

FIG. 6 is a top view thereof; and,

FIG. 7 is a bottom view thereof.

The broken lines in the drawings are for illustrative purpose only and form no part of the claimed design.

See application file for complete search history.

1 Claim, 5 Drawing Sheets

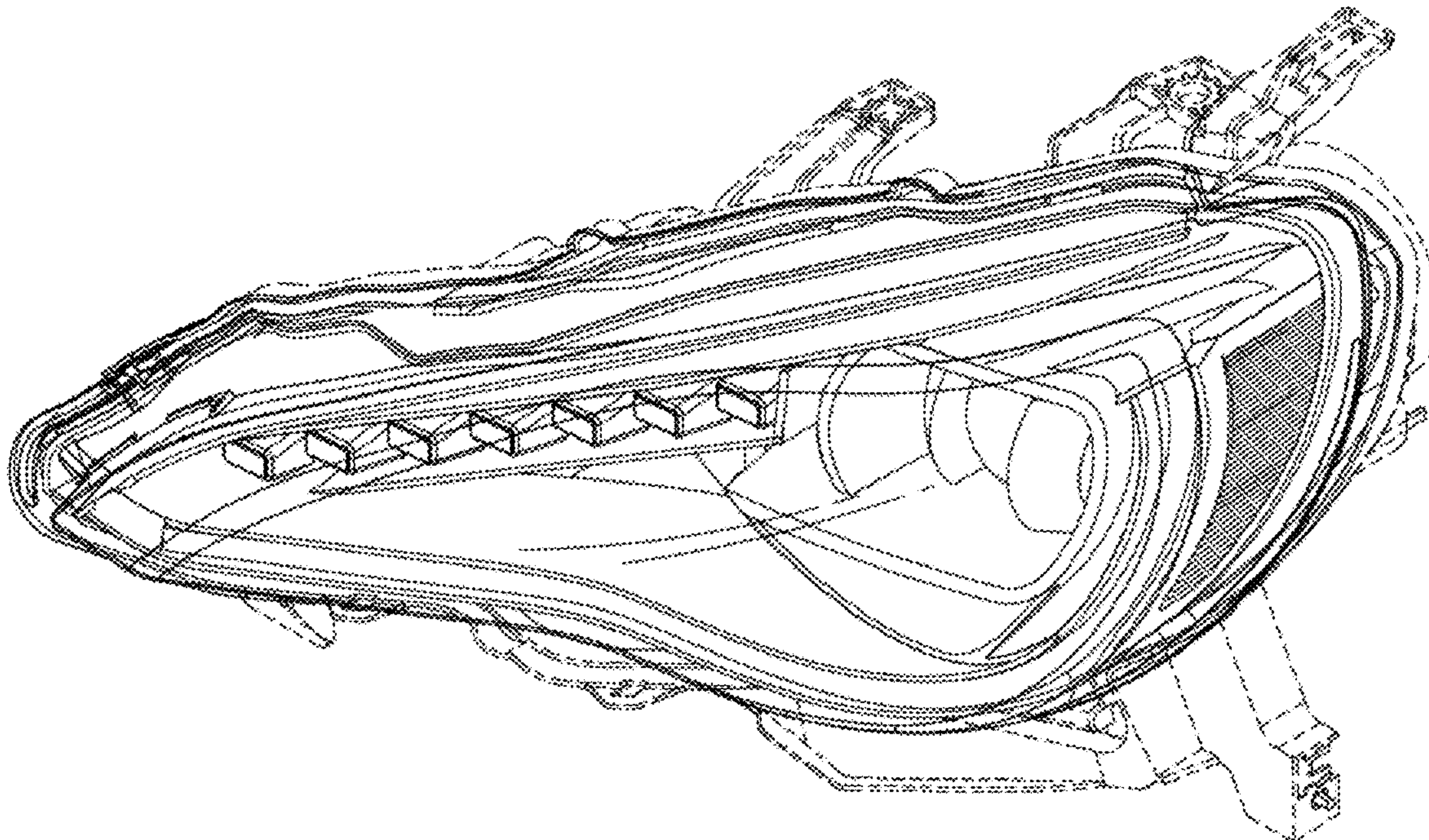

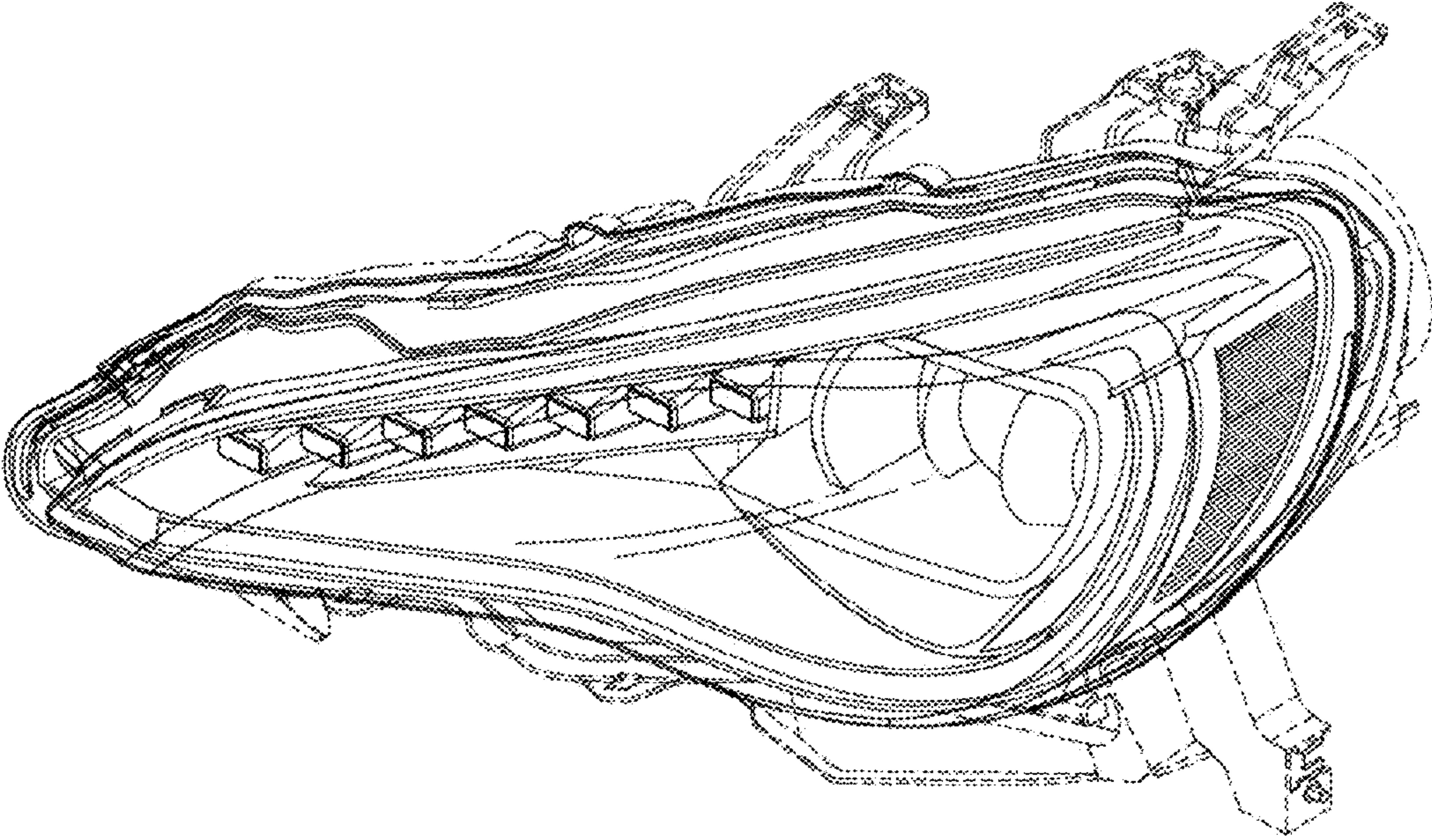

FIG. 1

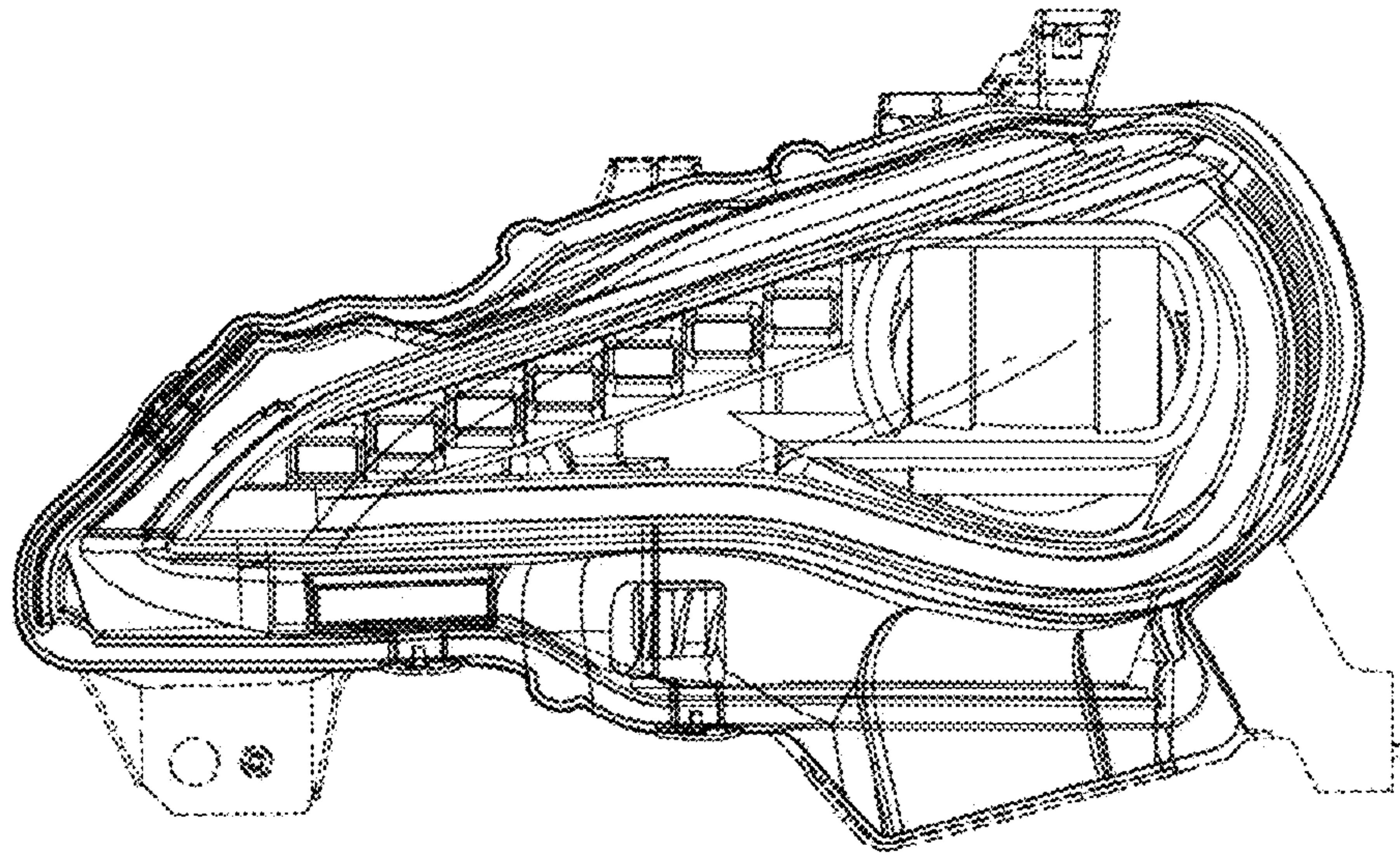

FIG. 2

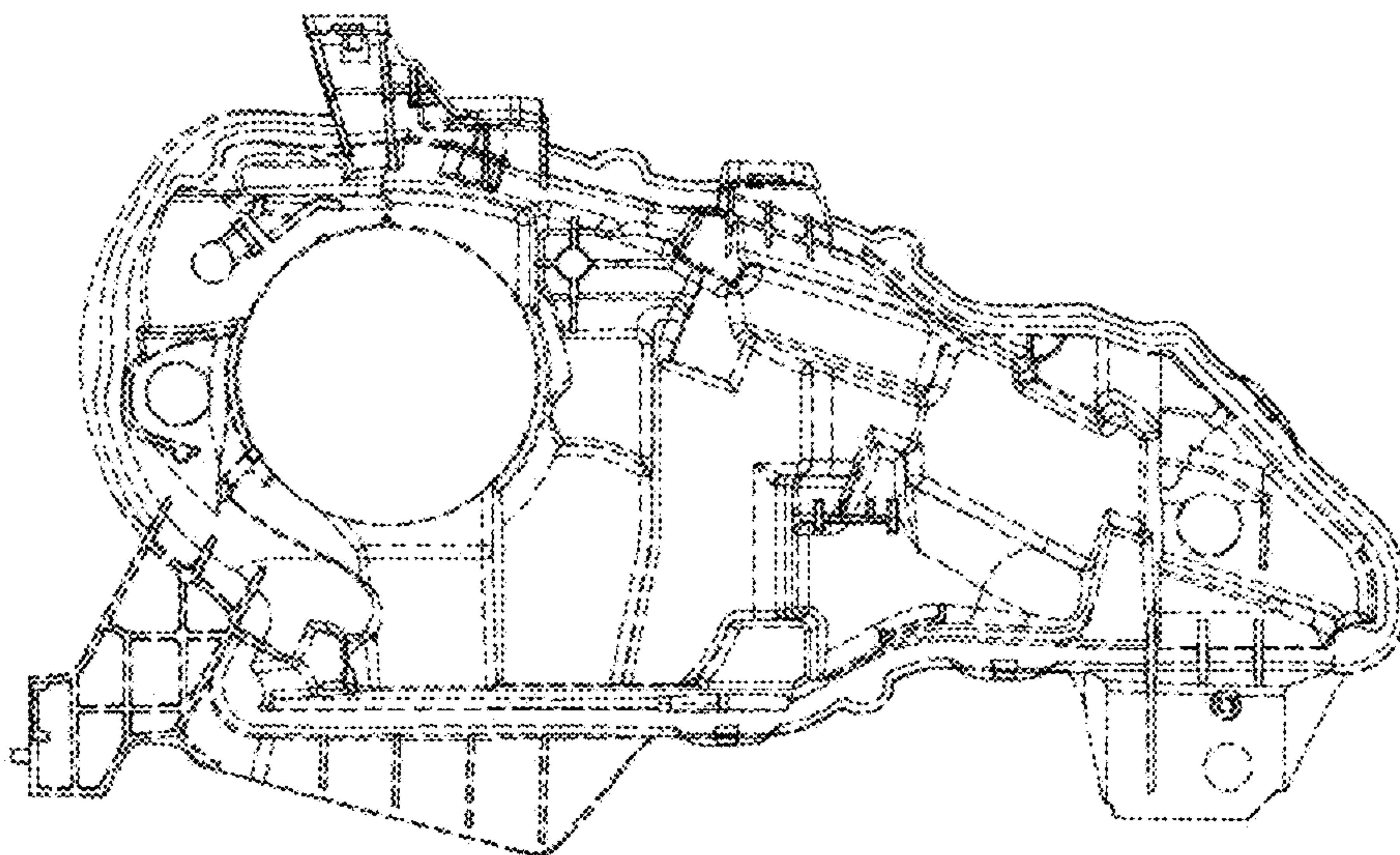

FIG. 3

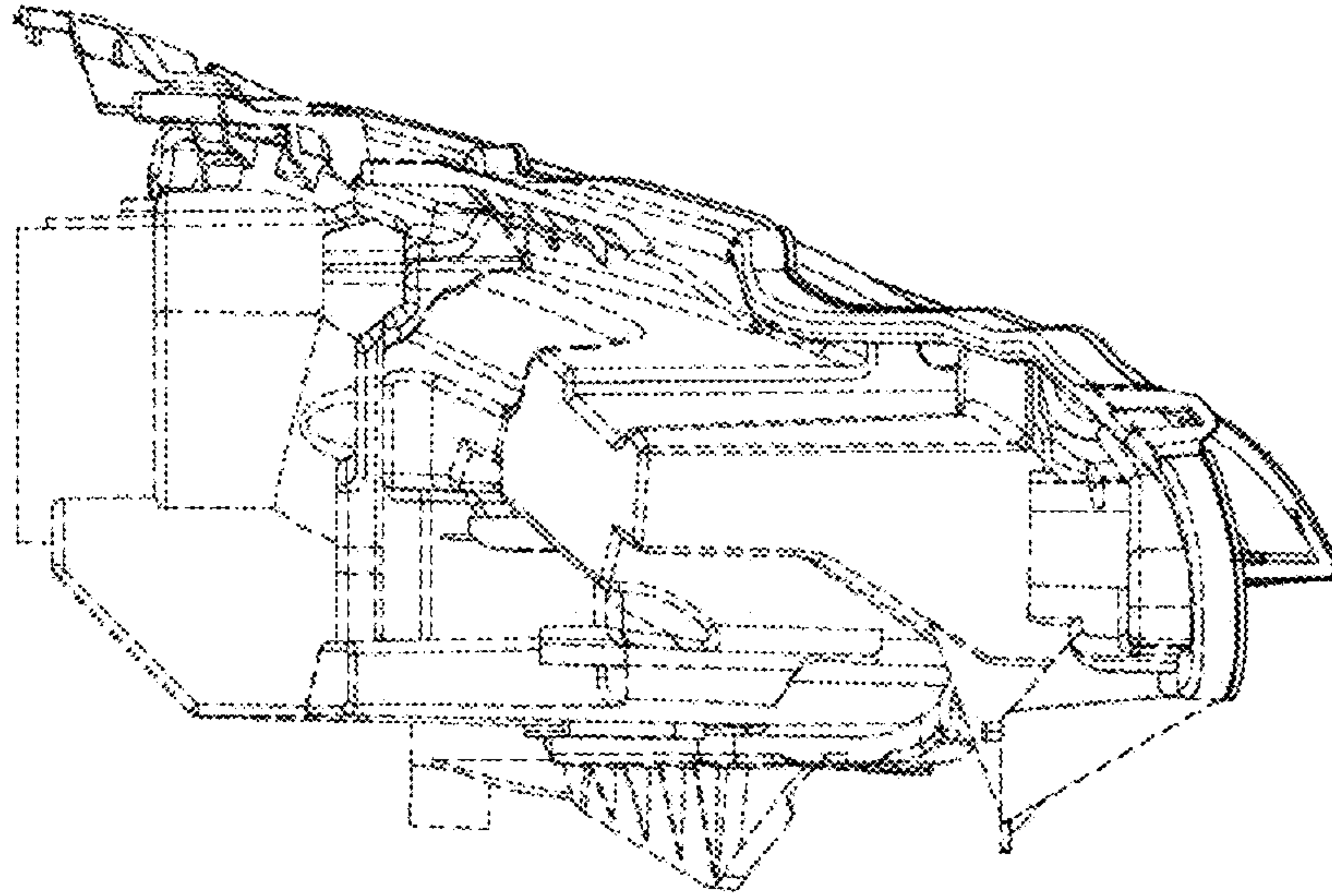

FIG. 4

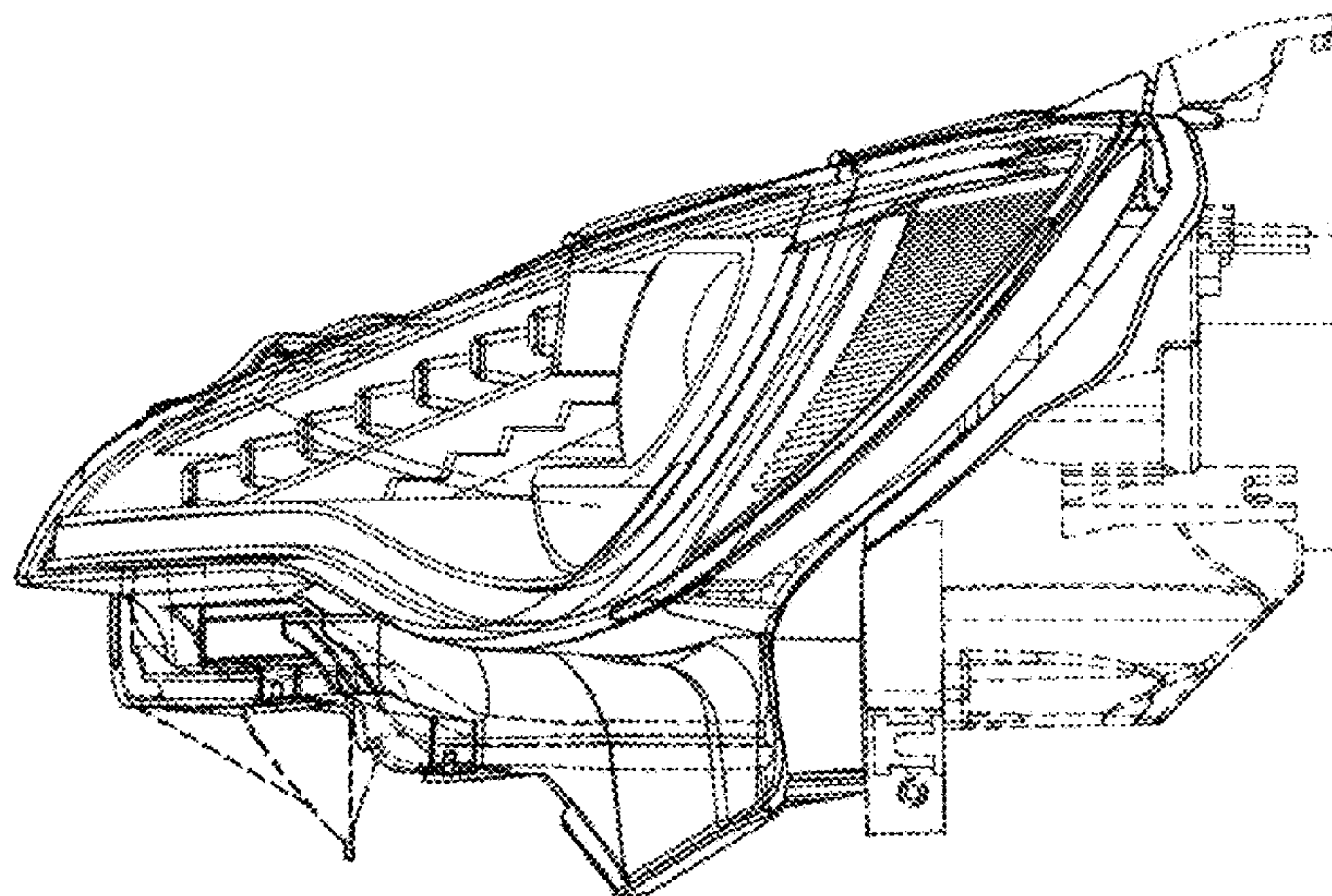

FIG. 5

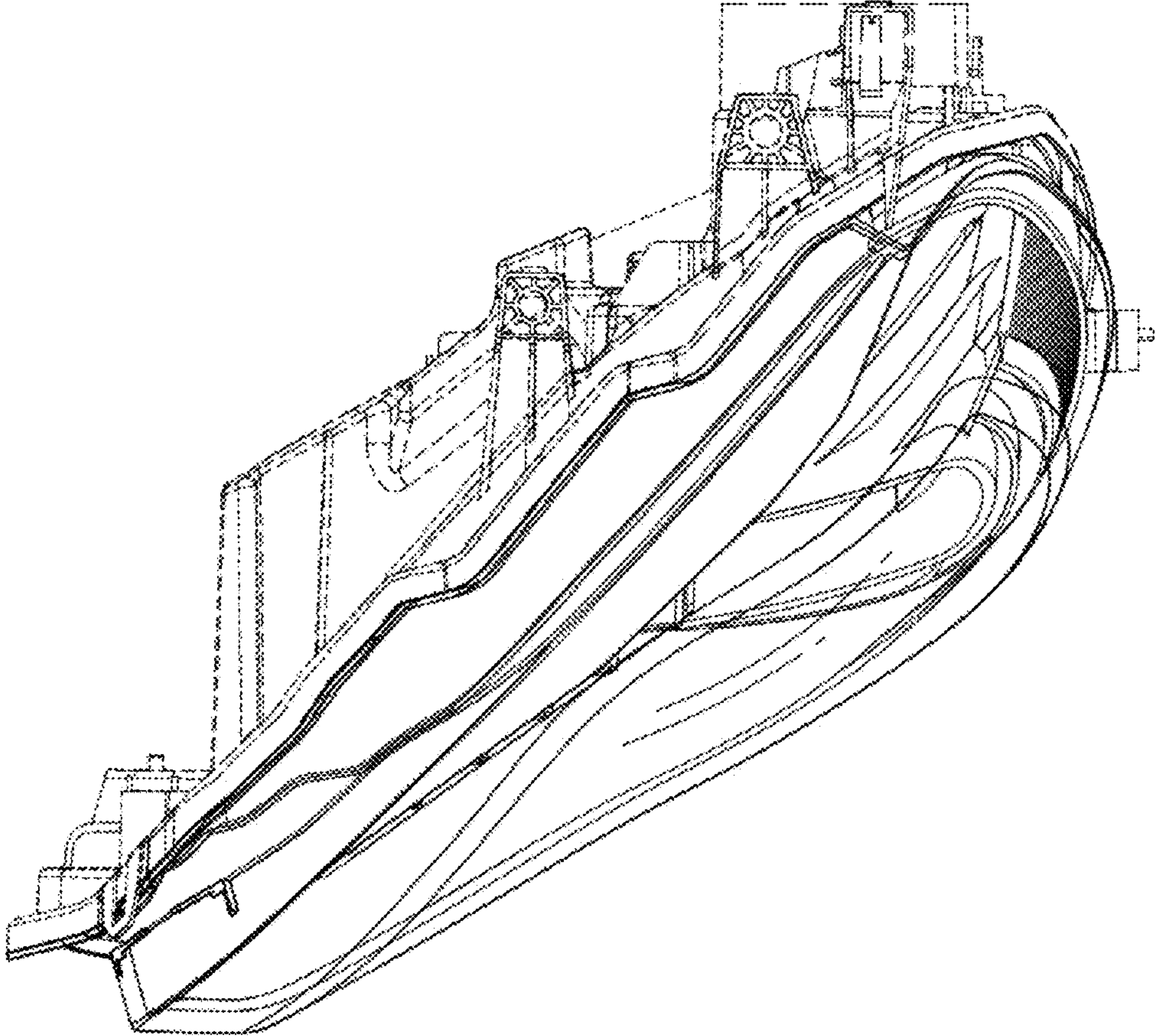

FIG. 6

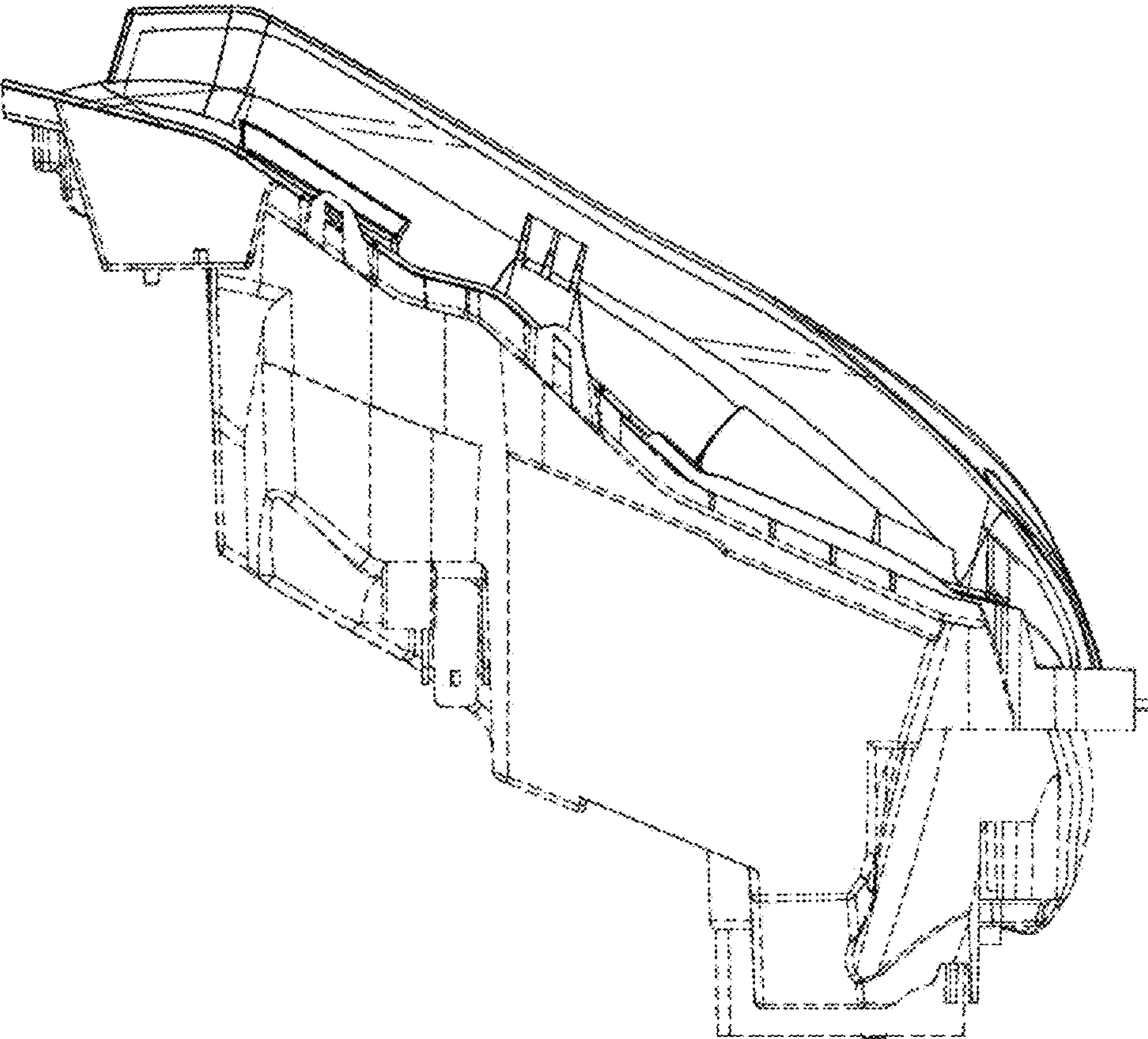

FIG. 7