



US00D701958S

(12) **United States Design Patent**
Griffis, III et al.

(10) **Patent No.:** **US D701,958 S**

(45) **Date of Patent:** **** Apr. 1, 2014**

(54) **SOFT TISSUE ANCHOR**

(71) Applicant: **MedShape, Inc.**, Atlanta, GA (US)

(72) Inventors: **Jack C. Griffis, III**, Decatur, GA (US);
Kenneth A. Gall, Atlanta, GA (US);
Kathryn Smith, Atlanta, GA (US);
Stephen Lee Laffoon, Atlanta, GA (US);
Annie E. Macedo, Wilbraham, MA (US);
Kadija N. McAnuff, Lawrenceville, GA (US);
Mary K. Pitz, Atlanta, GA (US)

(73) Assignee: **MedShape, Inc.**, Atlanta, GA (US)

(**) Term: **14 Years**

(21) Appl. No.: **29/435,554**

(22) Filed: **Oct. 25, 2012**

(51) **LOC (10) Cl.** **24-02**

(52) **U.S. Cl.**
USPC **D24/145**

(58) **Field of Classification Search**
USPC D24/145; D8/387; 606/60, 65, 86 R, 74,
606/95, 99, 104, 232, 308, 319
See application file for complete search history.

(56) **References Cited**

U.S. PATENT DOCUMENTS

6,168,598 B1 * 1/2001 Martello 606/74
6,283,973 B1 * 9/2001 Hubbard et al. 606/104

6,527,777 B2 * 3/2003 Justin 606/65
7,189,238 B2 * 3/2007 Lombardo et al. 606/232
8,048,158 B2 * 11/2011 Hays et al. 606/60
D657,872 S * 4/2012 Griffis et al. D24/145
D665,078 S * 8/2012 Griffis et al. D24/145
8,317,825 B2 * 11/2012 Stone 606/232
2007/0198017 A1 * 8/2007 Tschakaloff et al. 606/73
2010/0198258 A1 * 8/2010 Heaven et al. 606/232

* cited by examiner

Primary Examiner — Wan Laymon

(74) Attorney, Agent, or Firm — Furman IP Law

(57) **CLAIM**

The ornamental design for a soft tissue anchor, as shown and described.

DESCRIPTION

FIG. 1 is a perspective view of a new design for a soft tissue anchor;
FIG. 2 is a top view thereof;
FIG. 3 is a bottom view thereof;
FIG. 4 is a left side view thereof;
FIG. 5 is a right side view thereof;
FIG. 6 is a back thereof; and,
FIG. 7 is a front view thereof.

The broken line showing portion of a soft tissue anchor is included for illustrating environmental structure and forms no part of the claimed design.

1 Claim, 6 Drawing Sheets

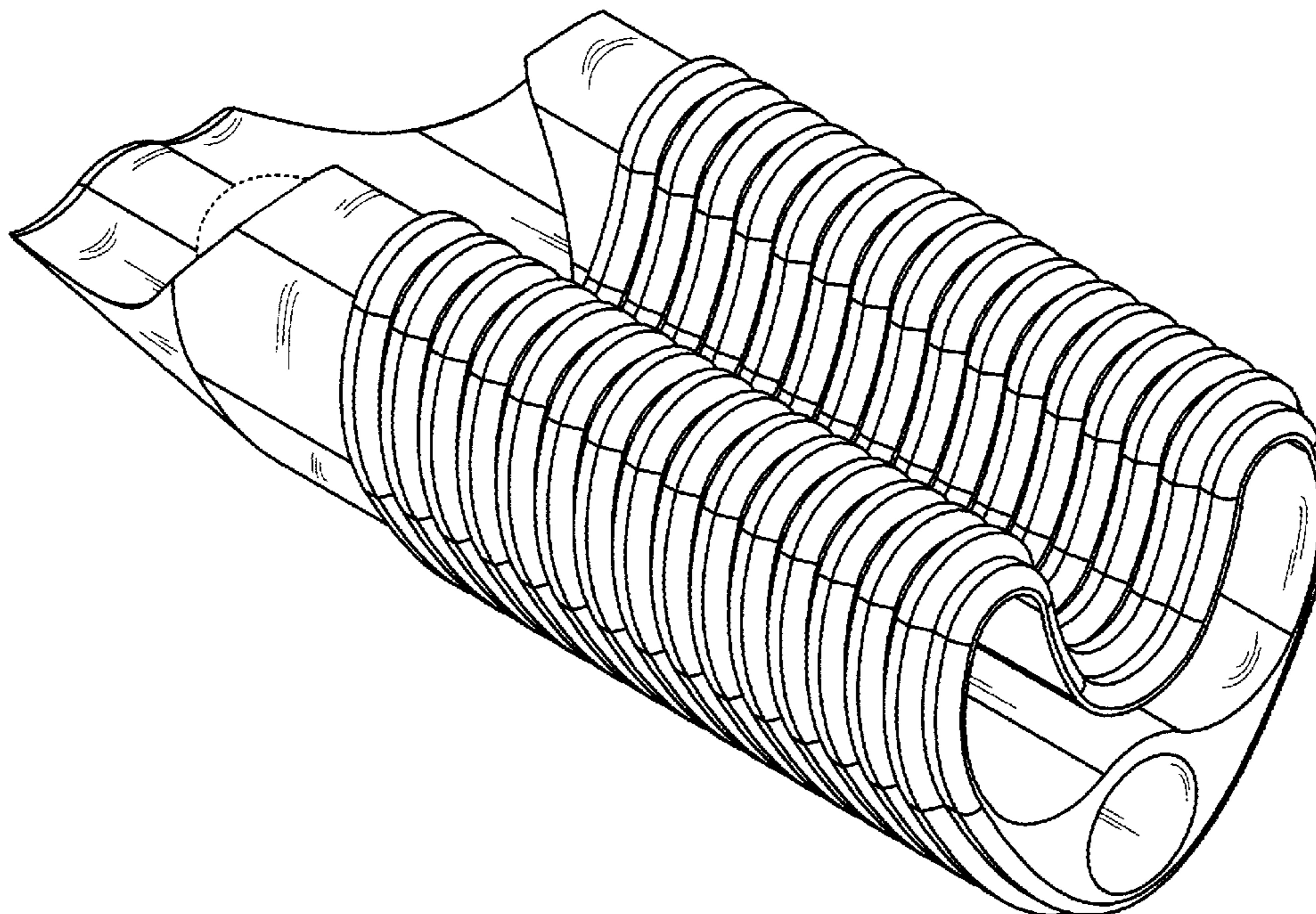

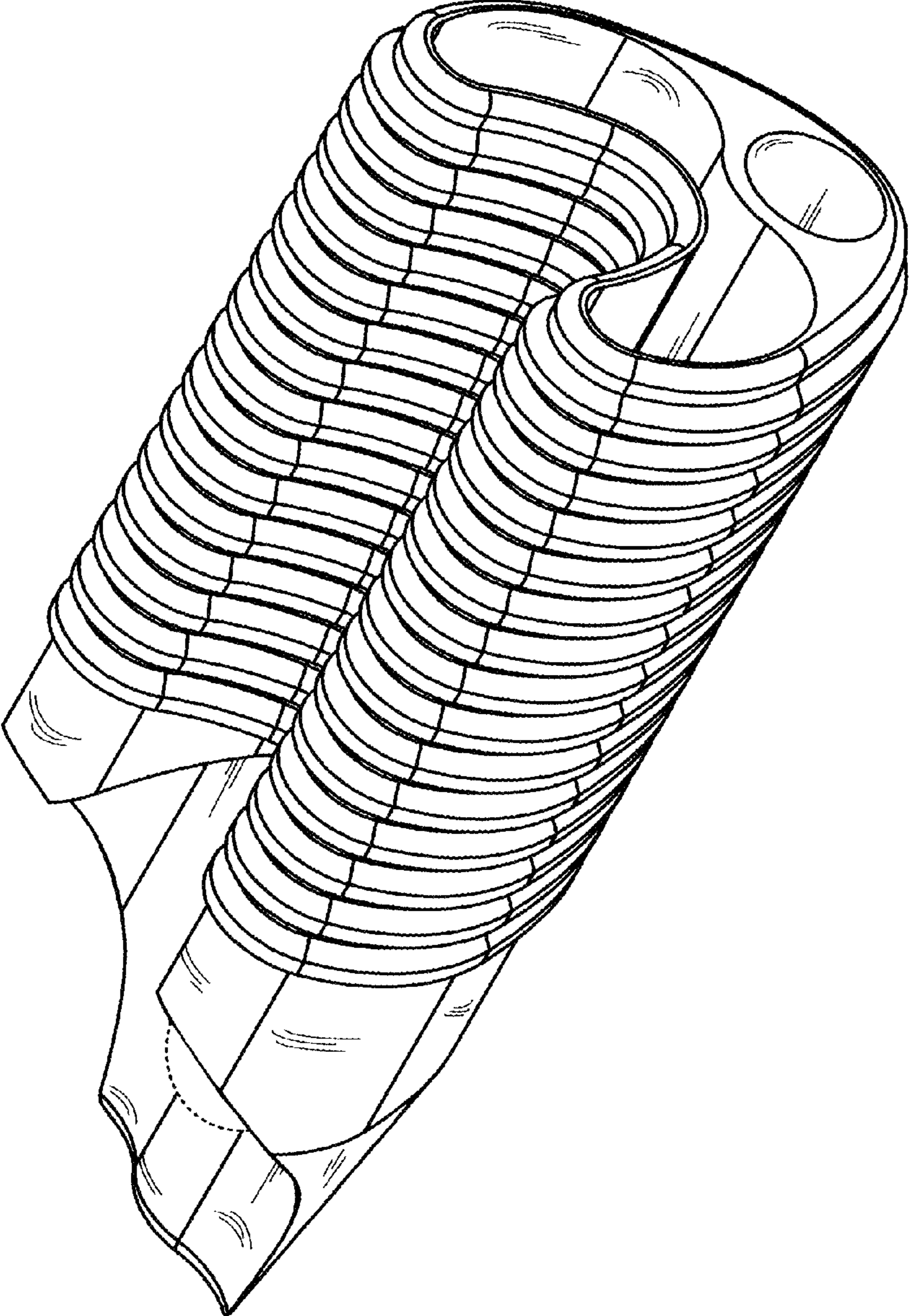

FIG. 1

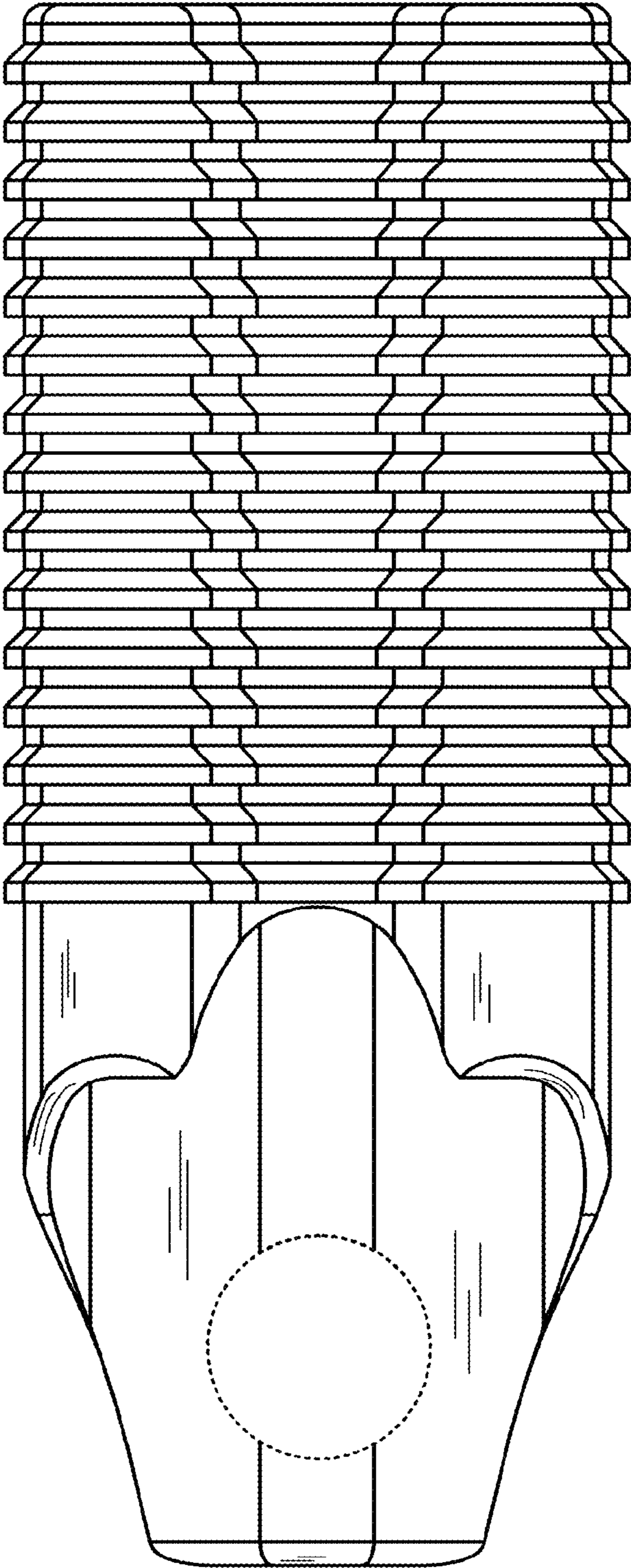

FIG. 2

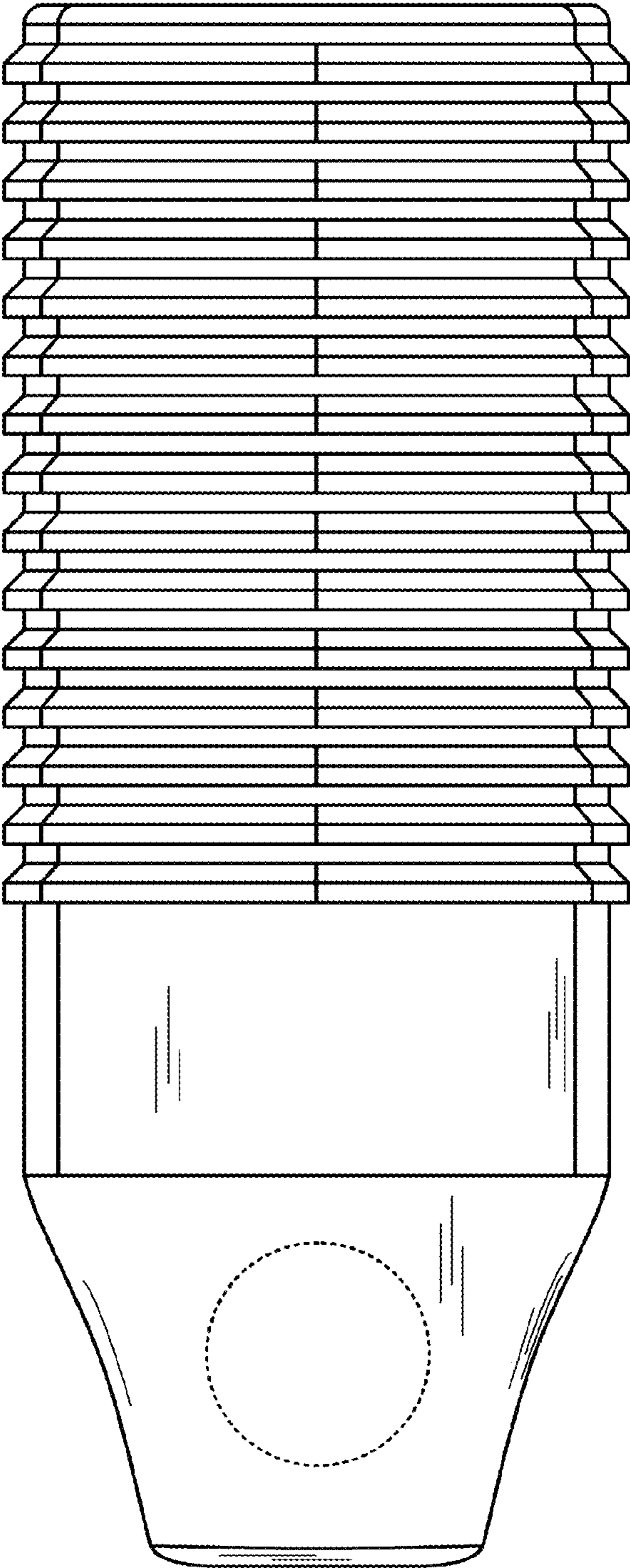

FIG. 3

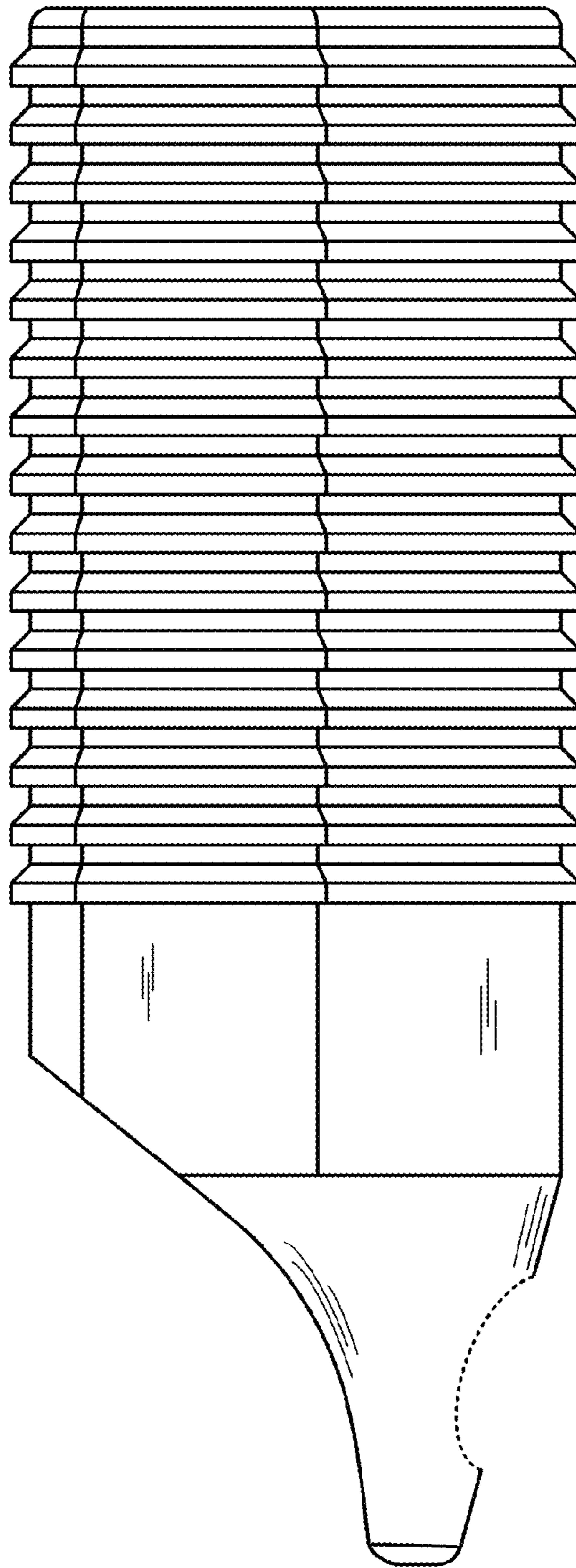

FIG. 4

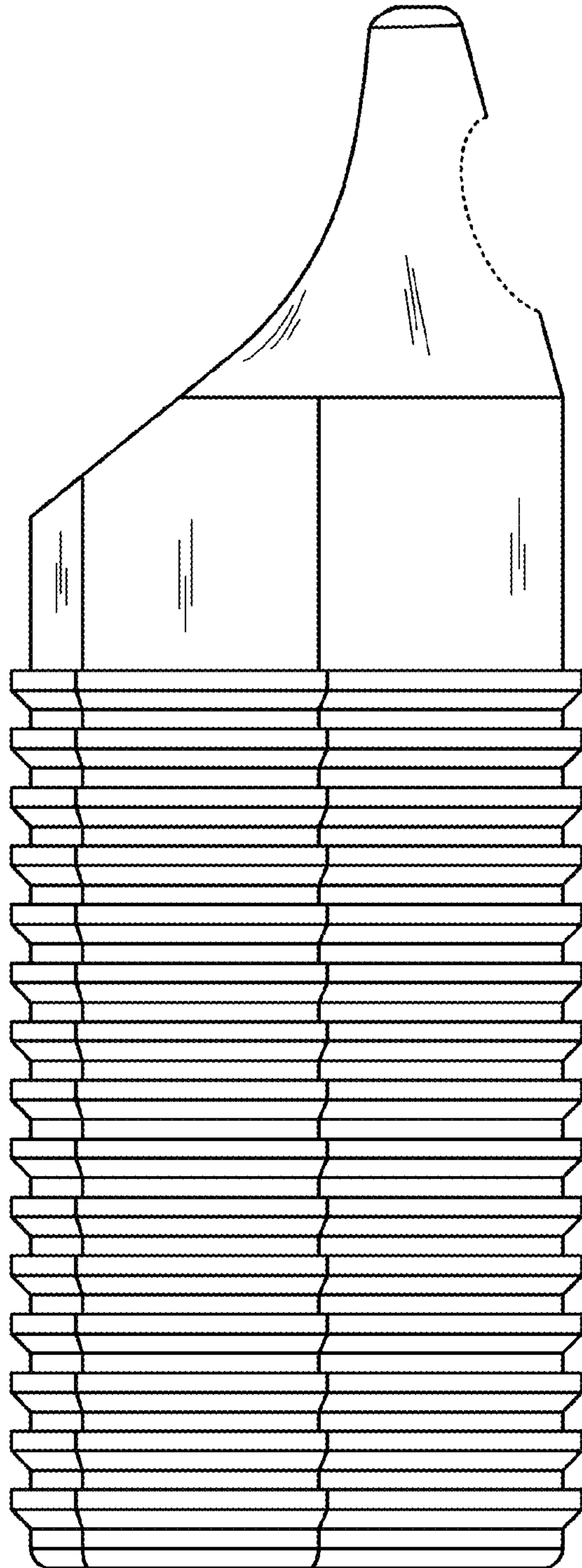

FIG. 5

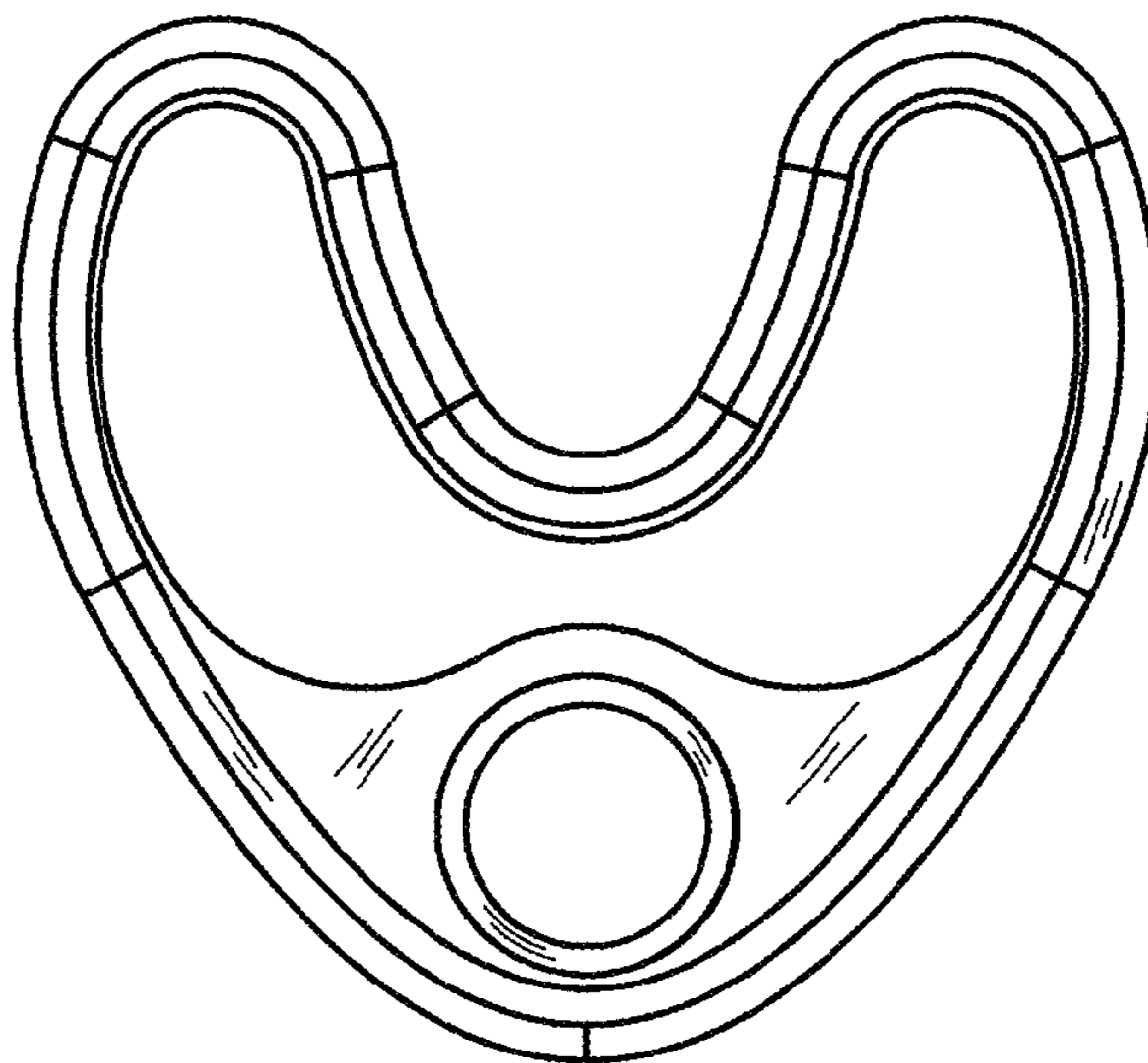

FIG. 6

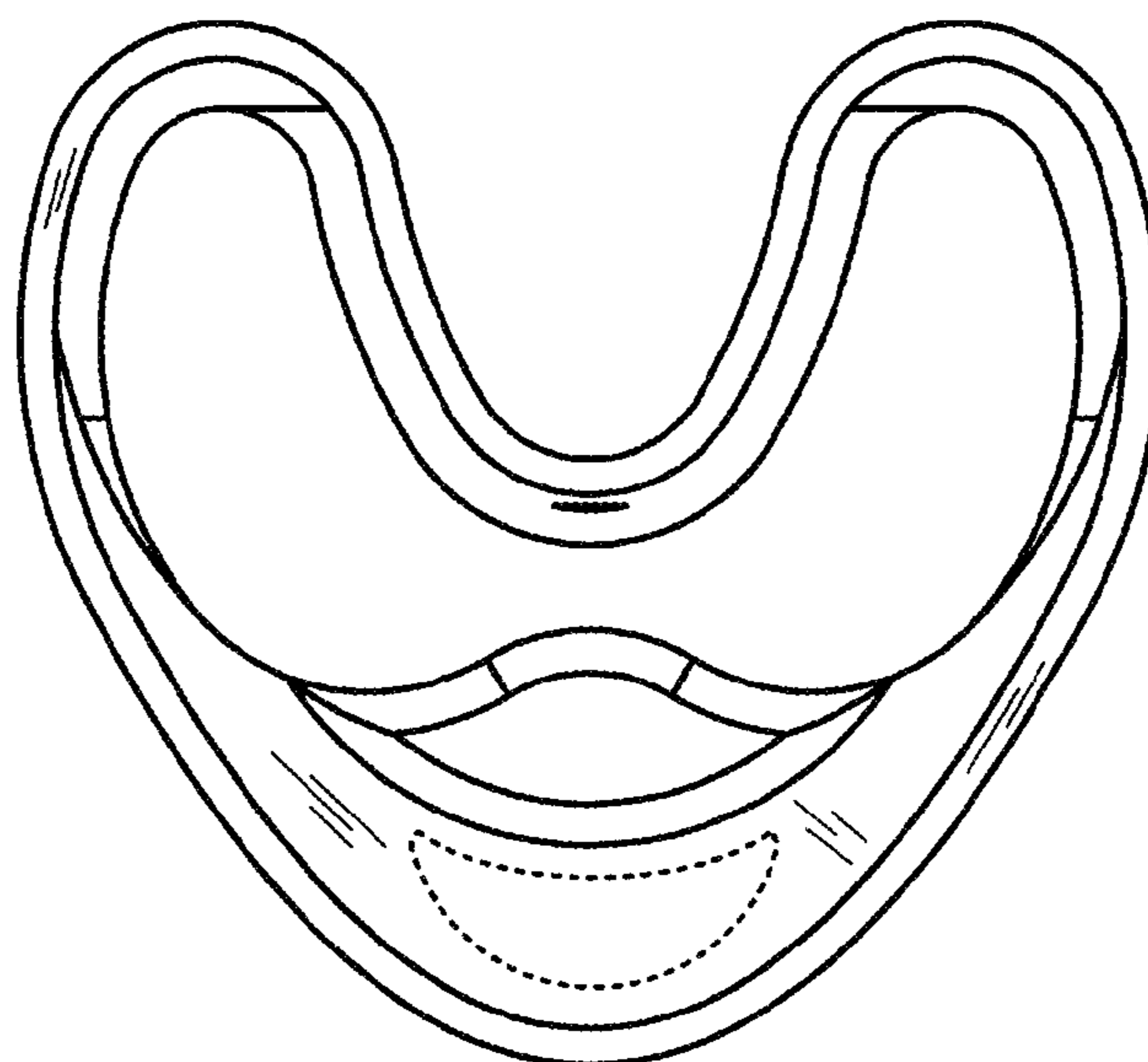

FIG. 7