



US00D701804S

(12) **United States Design Patent**
Campbell et al.

(10) **Patent No.:** **US D701,804 S**

(45) **Date of Patent:** **** Apr. 1, 2014**

(54) **VEHICLE LOWER GRILLE**

- (71) Applicant: **Ford Global Technologies, LLC**, Dearborn, MI (US)
- (72) Inventors: **Paul Campbell**, Essex (GB); **Paul Jonathan Alexander Wraith**, Essex (GB); **Simon Collins**, Kent (GB)
- (73) Assignee: **Ford Motor Company**, Dearborn, MI (US)
- (**) Term: **14 Years**
- (21) Appl. No.: **29/436,092**
- (22) Filed: **Nov. 1, 2012**

(30) **Foreign Application Priority Data**

May 4, 2012 (DE) 402012100346

(51) **LOC (10) Cl.** **12-16**

(52) **U.S. Cl.**
USPC **D12/169**

(58) **Field of Classification Search**
USPC D12/169, 196, 171, 216, 163, 86,
D12/90-92; 293/102, 113, 115, 117, 120;
296/180.1, 180.2

See application file for complete search history.

(56) **References Cited**

U.S. PATENT DOCUMENTS

D498,187 S	*	11/2004	Platto et al.	D12/163
D510,302 S	*	10/2005	Sugimoto	D12/163
D535,229 S	*	1/2007	Hara et al.	D12/169
D561,654 S	*	2/2008	Platto et al.	D12/163
D584,197 S	*	1/2009	Song et al.	D12/163
D593,460 S	*	6/2009	Schiavone et al.	D12/163
D605,094 S	*	12/2009	Bennett et al.	D12/163
D680,921 S	*	4/2013	Jara	D12/163

OTHER PUBLICATIONS

- Now on Jokeforblog, May 12, 2012 <http://jokeforblog.blogspot.com/2012/05/ford-transit-connect-leaked.html>.
- Garage Car 2013 Ford Transit Shows the new generation Tourneo Custom Concept, Mar. 7, 2012 <http://nashvillestories.blogspot.com/2012/03/2013-ford-transit-shows-new-generation.html>.
- Ford Unveils All-New 2014 Transit, Transit Connect, Transit Courier Vans, Sep. 6, 2012 <http://rumors.automobilemag.com/ford-unveils-all-new-2013-transit-connect-for-europe-167369.html#axzz2KbpT6e2s>.
- CarAdvice Ford Transit Custom previews new commercial van range, Apr. 19, 2012 <http://www.caradvice.com.au/168987/ford-transit-custom-previews-new-commercial-van-range/ford-transit-custom-concept-4>.
- Ford Tourneo Custom Concept previews next-gen Transit range, Feb. 22, 2012 <http://www.gizmag.com/ford-tourneo-transit-private-commercial-van/21554/>.

* cited by examiner

Primary Examiner — Melody Brown

(74) *Attorney, Agent, or Firm* — Damian Porcari

(57) **CLAIM**

The ornamental design for a vehicle lower grille, shown and described.

DESCRIPTION

FIG. 1 is a top plan view of a vehicle lower grille;
 FIG. 2 is a bottom plan view of the vehicle lower grille;
 FIG. 3 is a front elevational view of the vehicle lower grille;
 FIG. 4 is a left side elevational view of the vehicle lower grille;
 FIG. 5 is a right side elevational view of the vehicle lower grille;
 FIG. 6 is a perspective view of the vehicle lower grille; and,
 FIG. 7 is another perspective view of the vehicle lower grille.

1 Claim, 7 Drawing Sheets

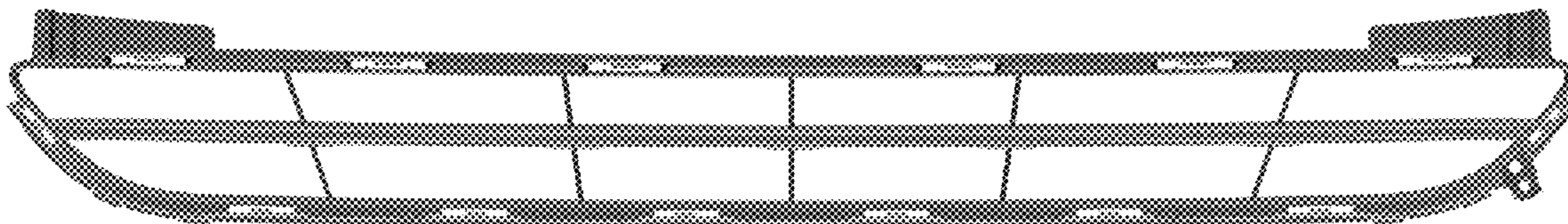

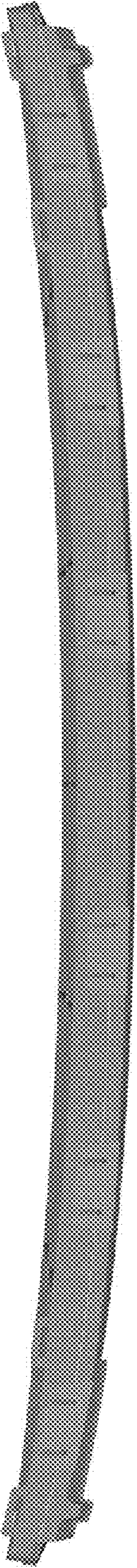

Figure 1

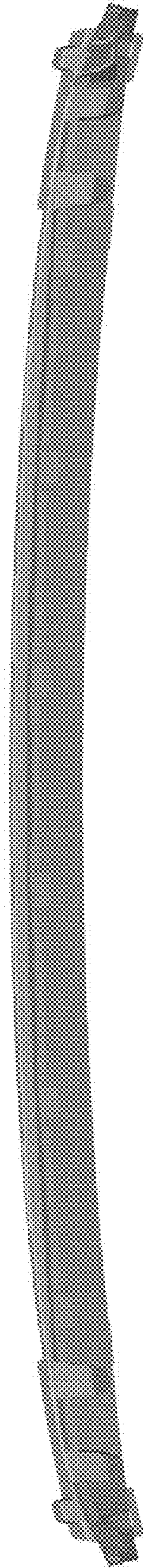

Figure 2

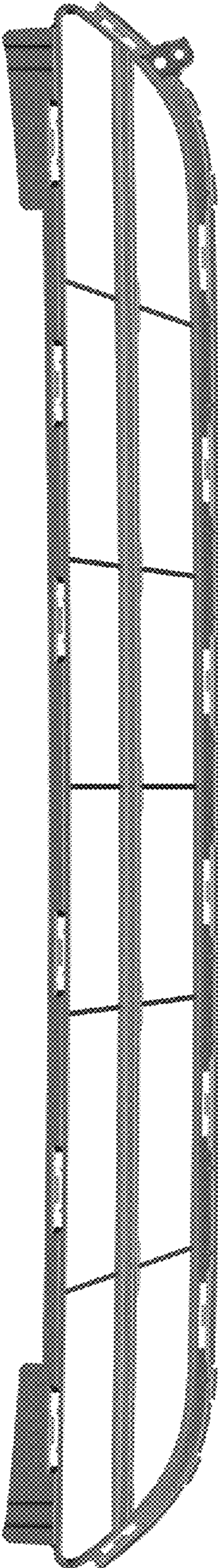

Figure 3

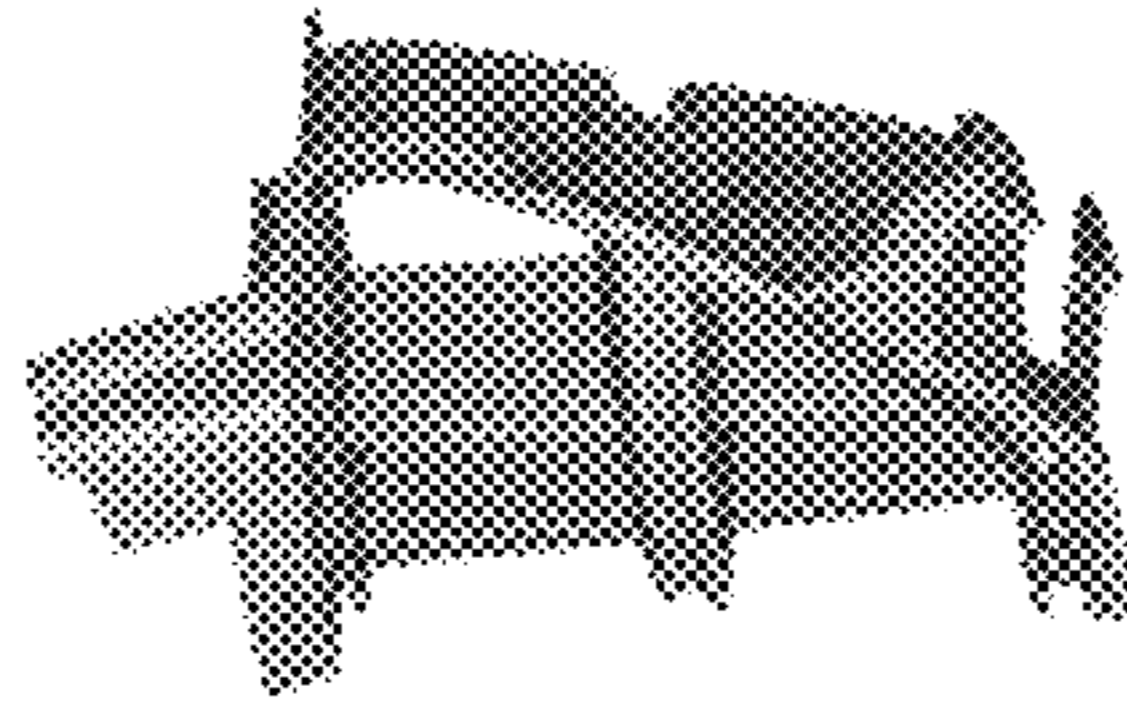

Figure 4

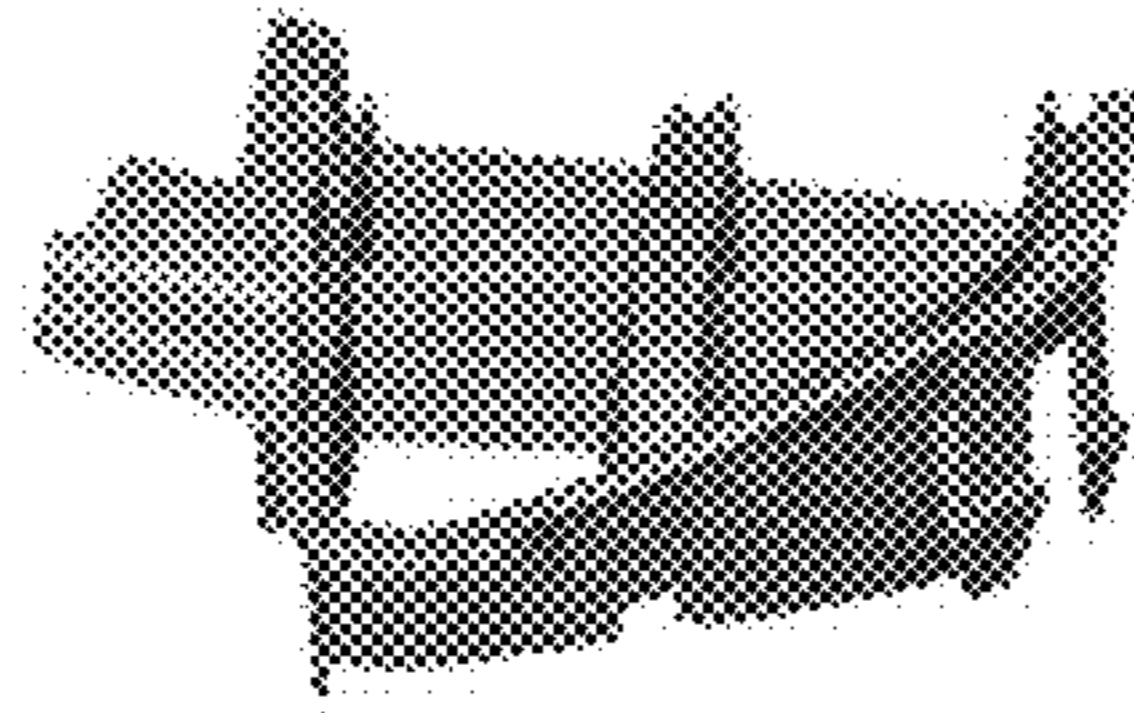

Figure 5

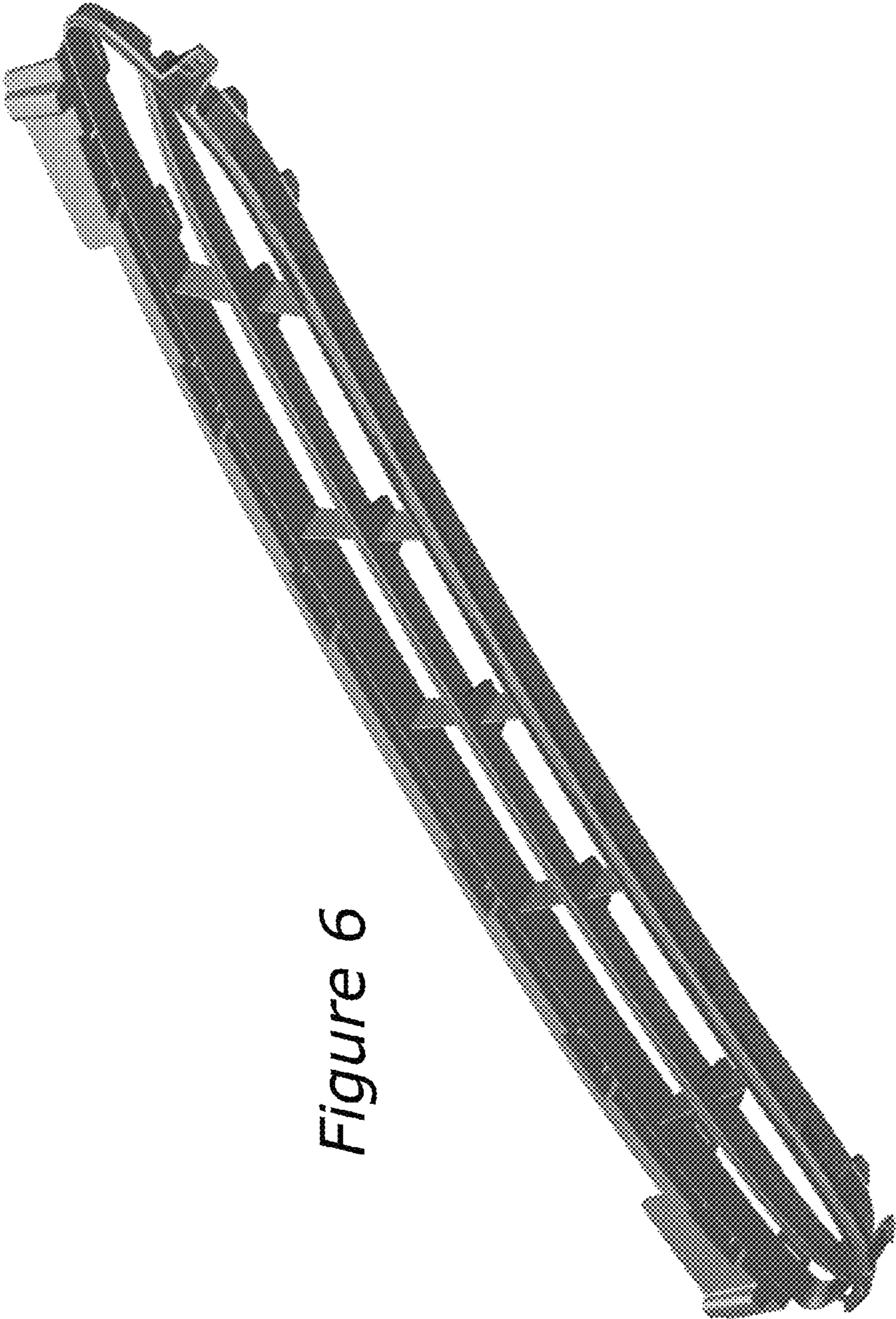

Figure 6

Figure 7

