



US00D701652S

(12) **United States Design Patent**
Roberts

(10) **Patent No.:** **US D701,652 S**
(45) **Date of Patent:** **** Mar. 25, 2014**

(54) **SHELTER**

(75) Inventor: **John Roberts, Essex (GB)**

(73) Assignee: **Petz Podz Limited (GB)**

(**) Term: **14 Years**

(21) Appl. No.: **29/417,295**

(22) Filed: **Apr. 2, 2012**

(30) **Foreign Application Priority Data**

Oct. 3, 2011	(EM)	001926395-0001
Oct. 3, 2011	(EM)	001926395-0002
Oct. 3, 2011	(EM)	001926395-0003
Oct. 3, 2011	(EM)	001926395-0004
Oct. 3, 2011	(EM)	001926395-0005
Oct. 3, 2011	(EM)	001926395-0006

(51) **LOC (10) Cl.** **30-02**

(52) **U.S. Cl.**
USPC **D30/108**

(58) **Field of Classification Search**
USPC D30/108-109, 112-117, 118;
119/452-453, 482, 489, 496-498,
119/500-501, 28.5
See application file for complete search history.

(56) **References Cited**

U.S. PATENT DOCUMENTS

D203,972 S	*	3/1966	Daugherty	D30/117
D224,792 S	*	9/1972	Knox	D30/118

D245,190 S	*	7/1977	Higo	D30/108
D245,348 S	*	8/1977	Haviland	D30/114
D321,068 S	*	10/1991	Shantz et al.	D30/108
D387,507 S	*	12/1997	Willinger et al.	D30/108
D467,041 S	*	12/2002	Cortes-Reuter	D30/109
6,539,895 B2	*	4/2003	Hoagland	119/453
D522,183 S	*	5/2006	Wylie	D30/118
D523,182 S	*	6/2006	Lieu	D30/108
D591,459 S	*	4/2009	Melerine	D30/112
D605,367 S	*	12/2009	Northrop	D30/115
D650,533 S	*	12/2011	Reick	D30/108
D676,613 S	*	2/2013	Chiu	D30/118

* cited by examiner

Primary Examiner — Cathy A MacCormac

(74) *Attorney, Agent, or Firm* — Barnes & Thornburg LLP

(57) **CLAIM**

The ornamental design for a shelter, as shown and described.

DESCRIPTION

FIG. 1 is a left side perspective view of one side of a shelter showing my new design,
FIG. 2 is a top perspective view thereof,
FIG. 3 is a rear perspective view thereof,
FIG. 4 is a top, right side and rear perspective view there,
FIG. 5 is a front perspective view thereof,
FIG. 6 is another perspective view of FIG. 4 showing the shelter opened; and,
FIG. 7 is a front perspective view of, FIG. 6.
The bottom view of the design is plain. The illustrations of the design are not to depict any particular color.

1 Claim, 5 Drawing Sheets

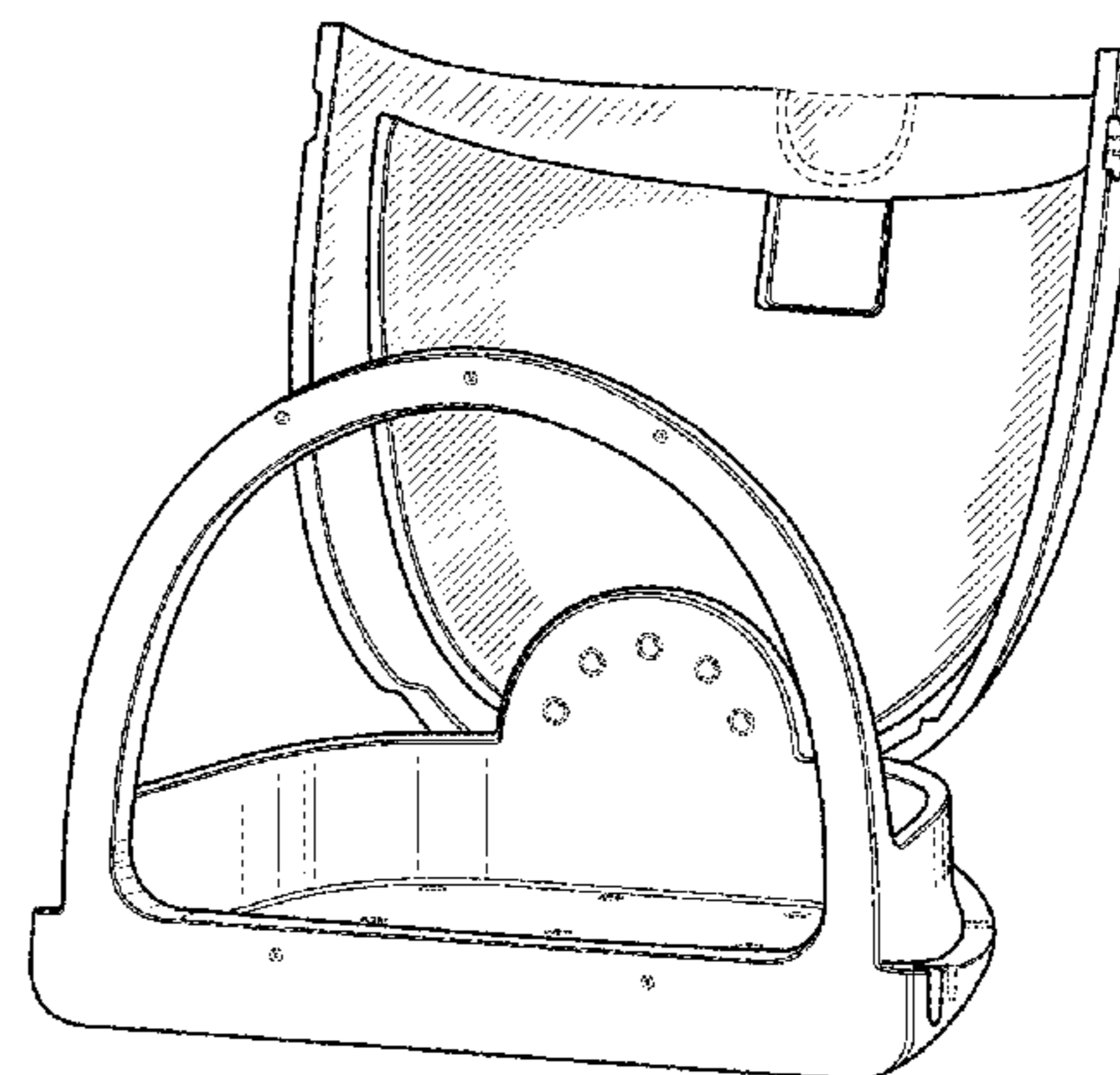
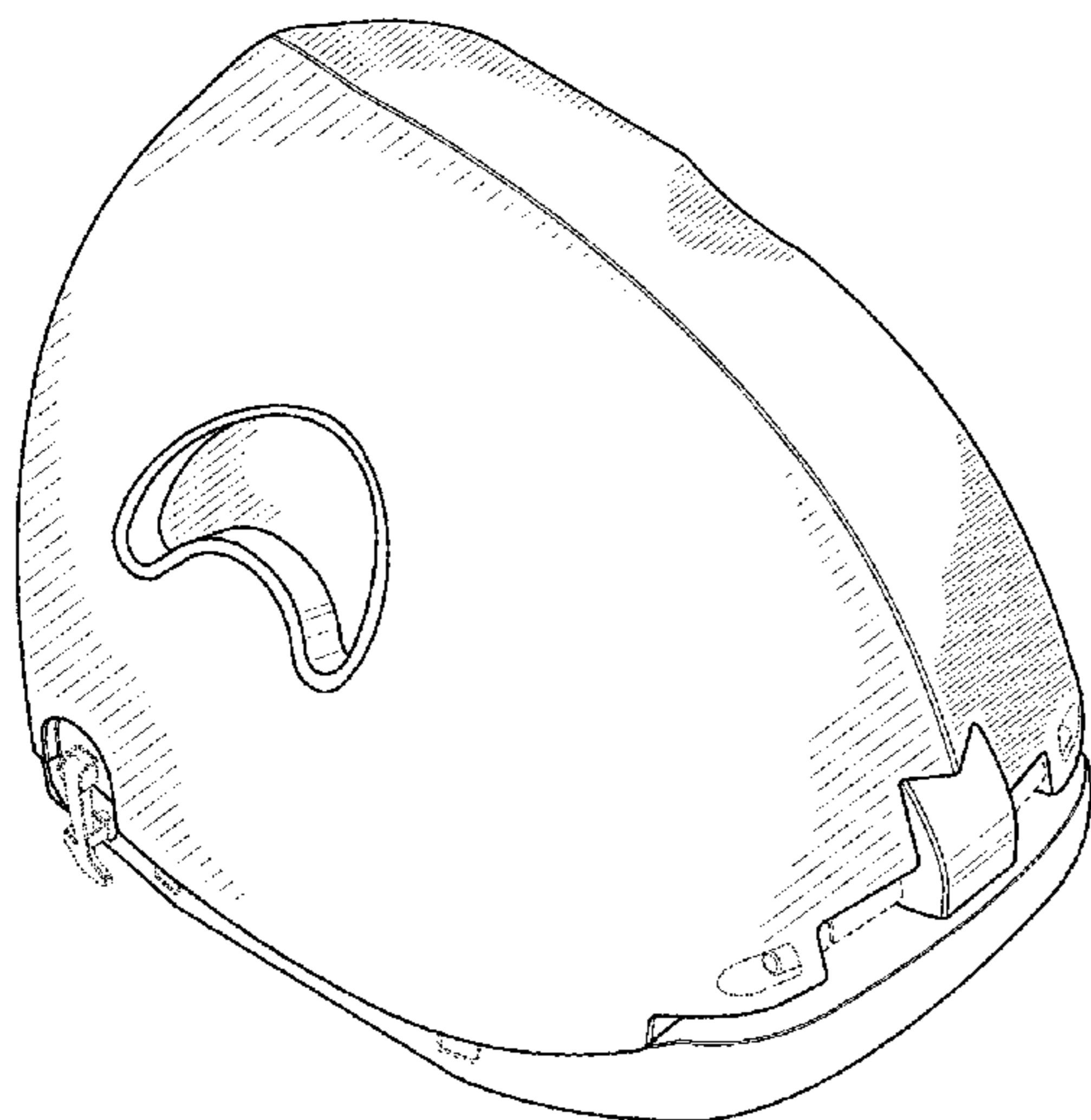

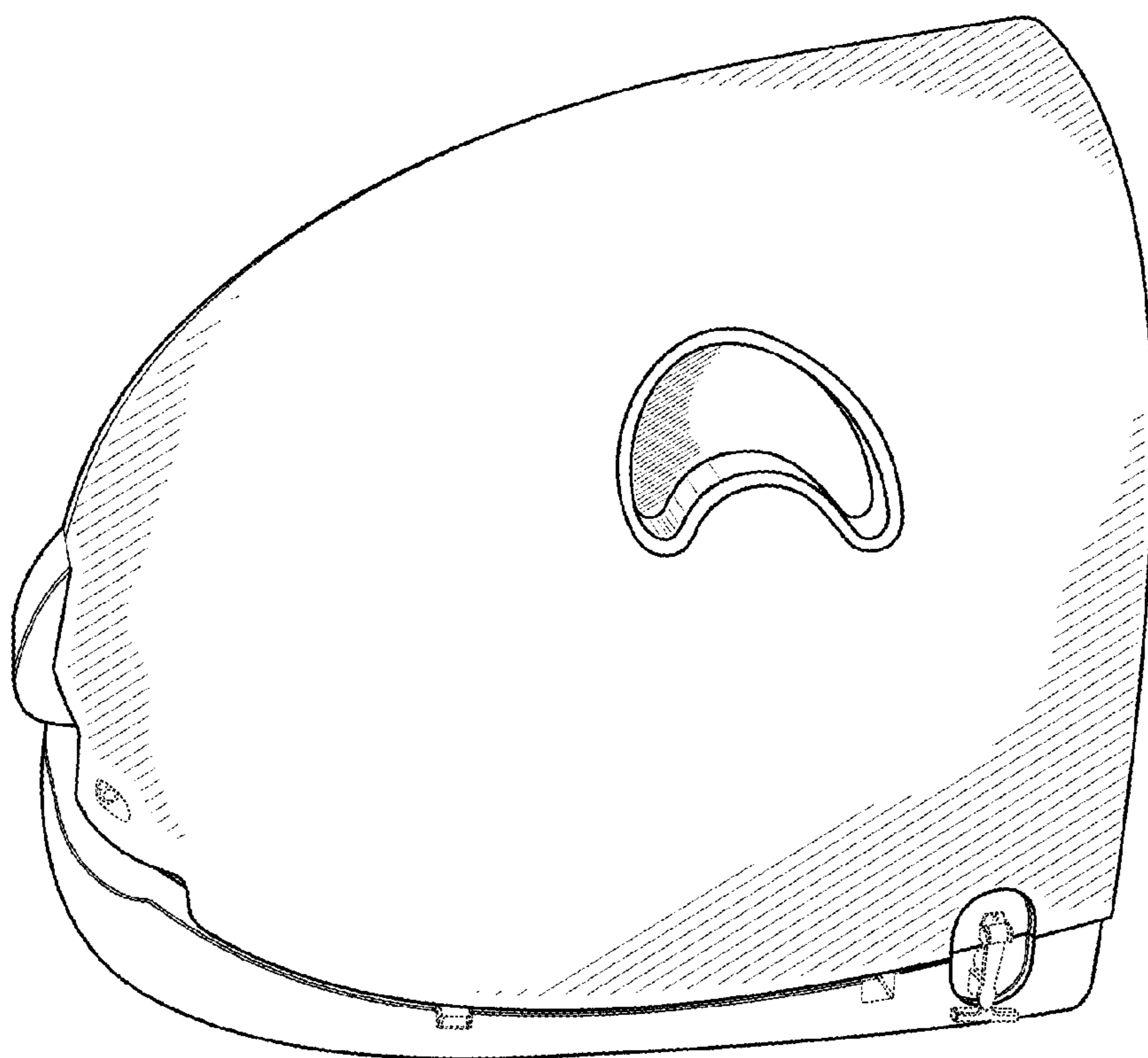

FIG. 1

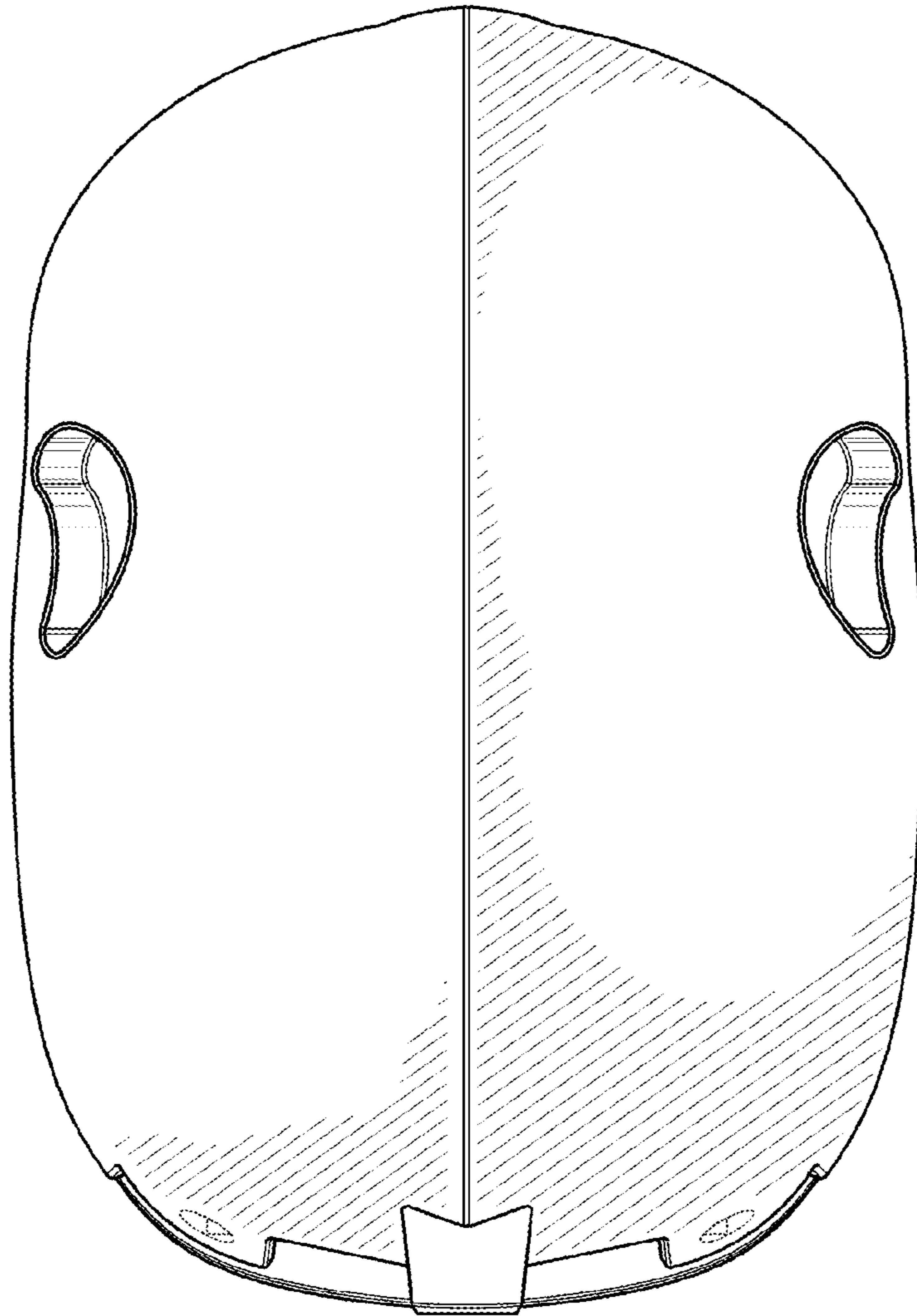

FIG. 2

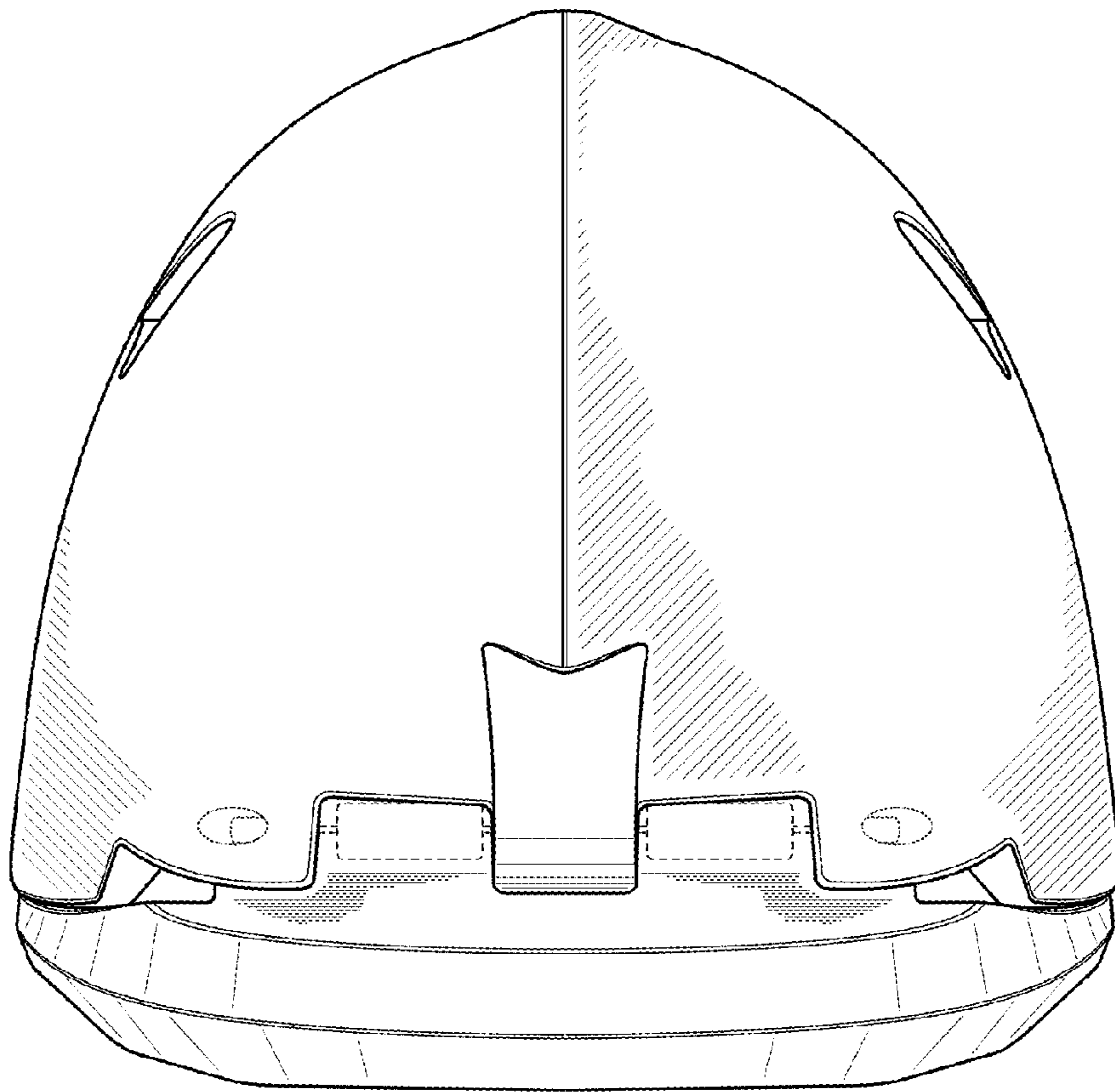

FIG. 3

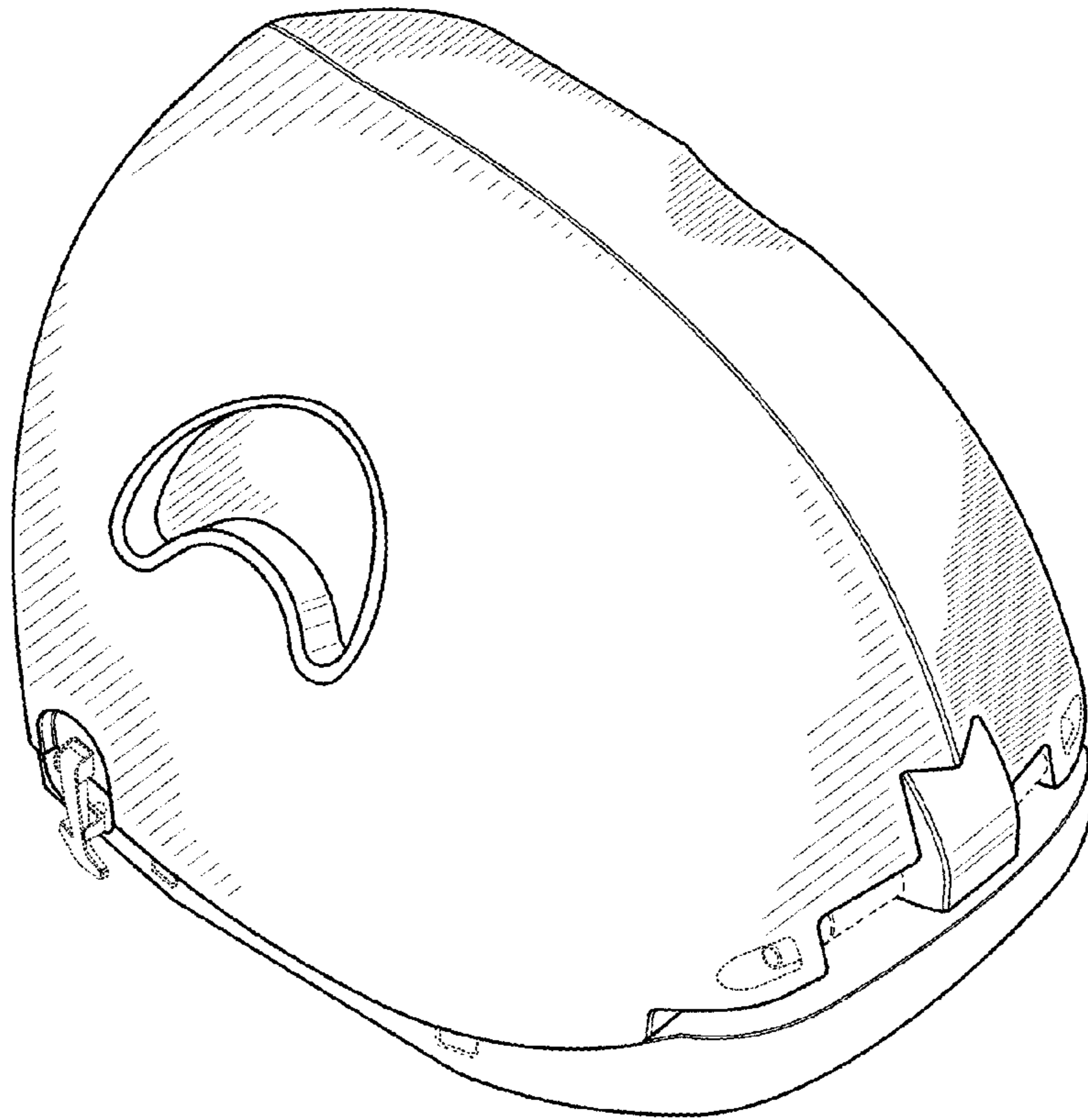

FIG. 4

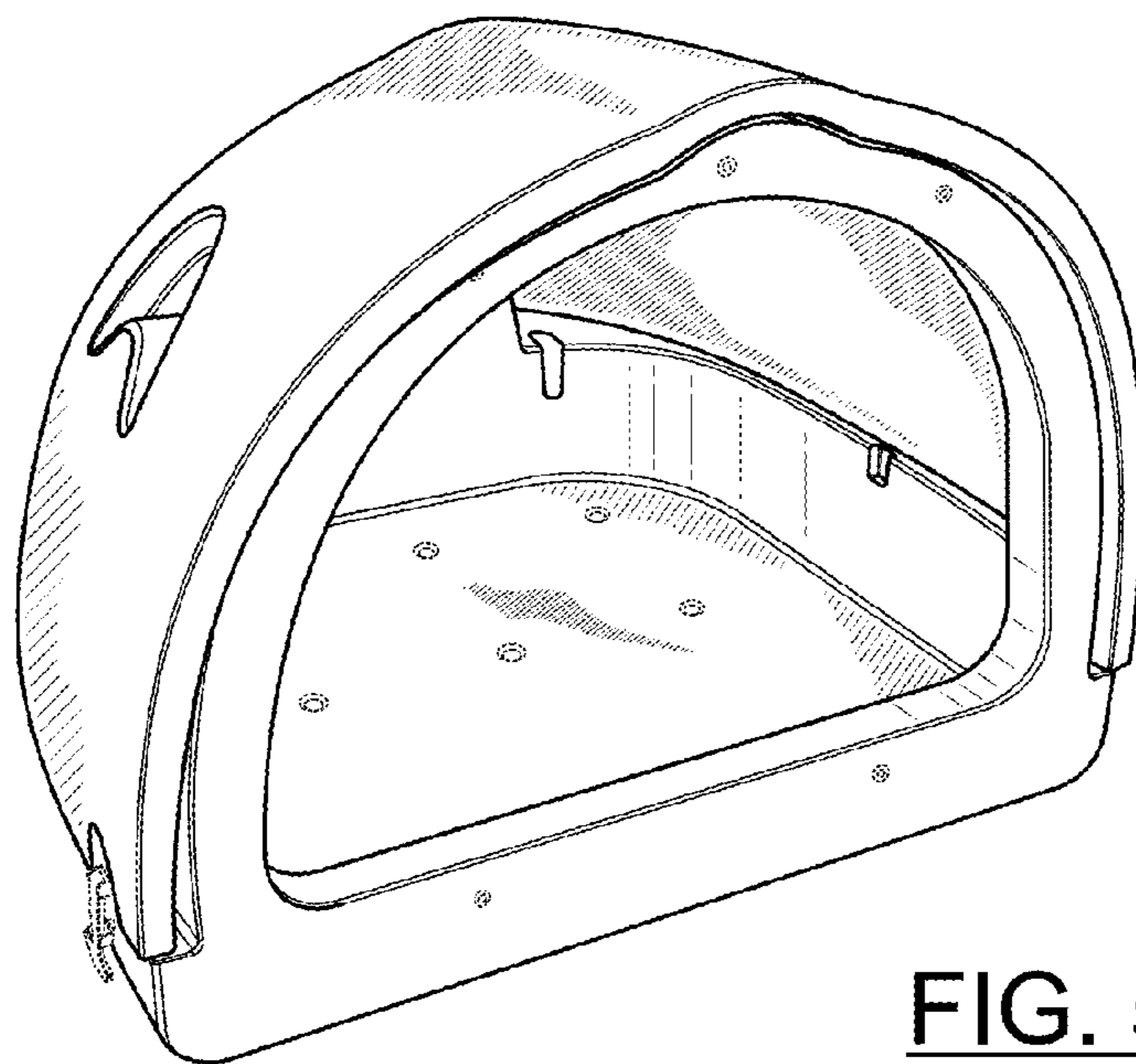

FIG. 5

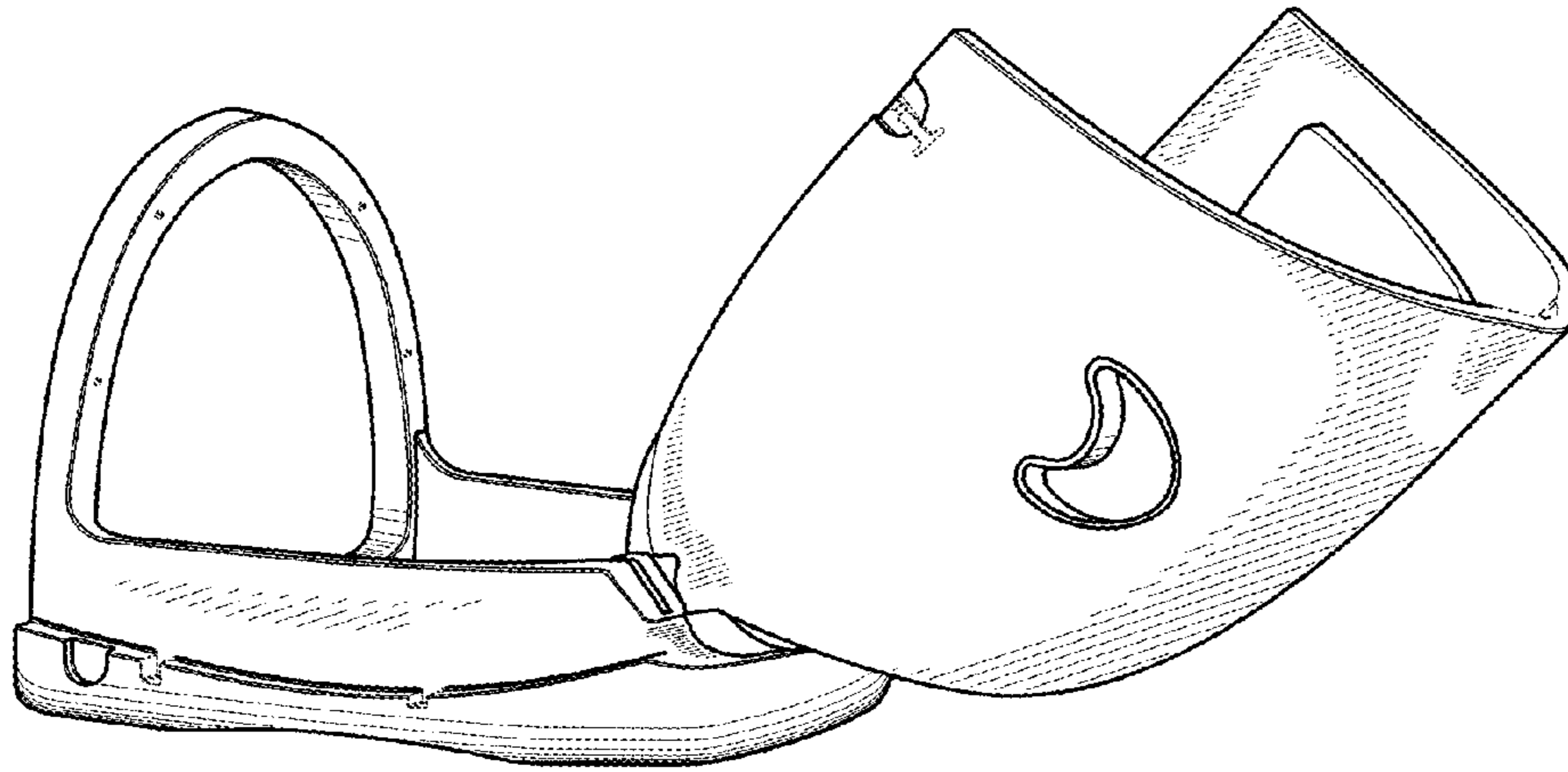

FIG. 6

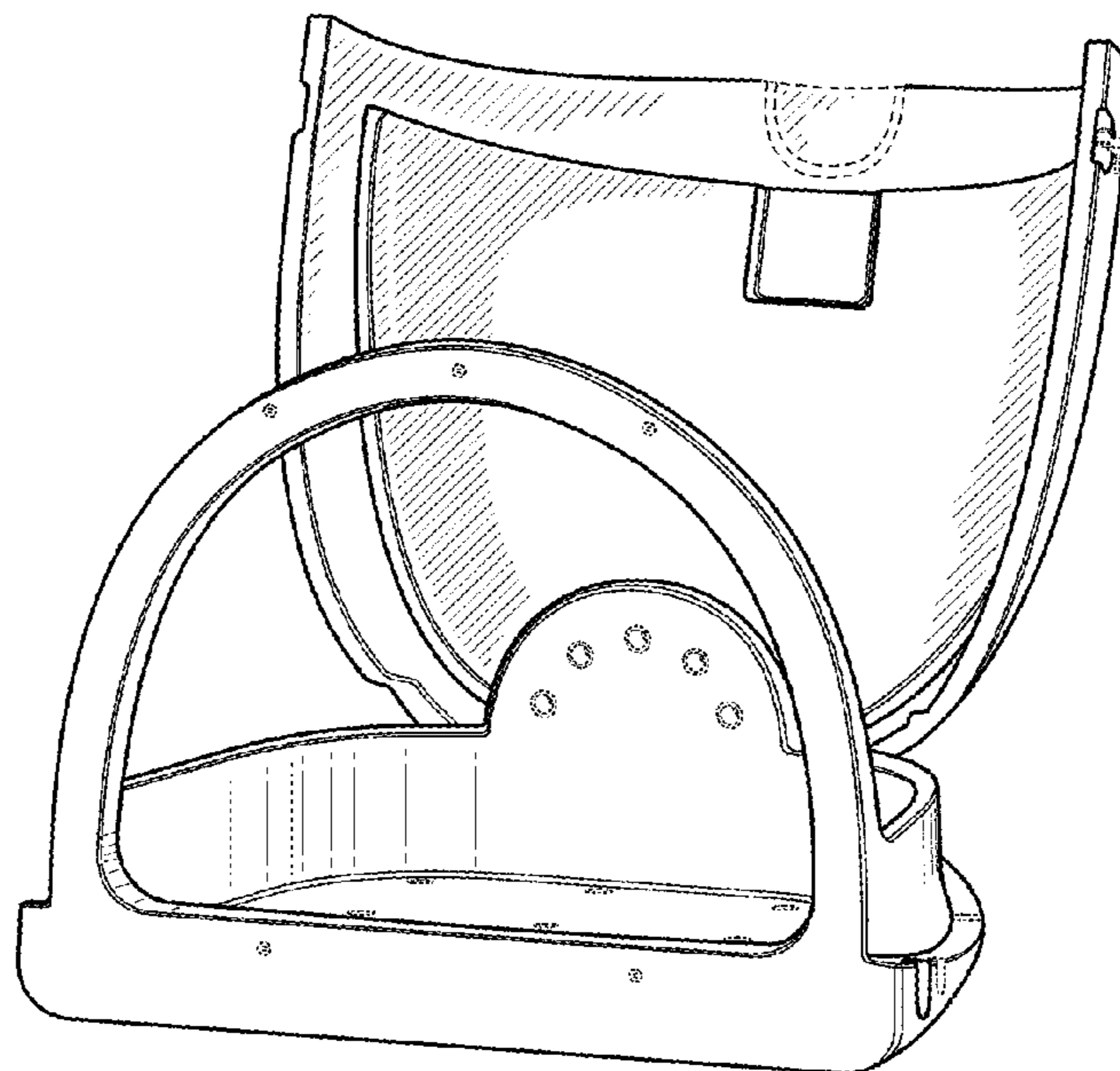

FIG. 7