



US00D701619S

(12) **United States Design Patent**
Pacitto

(10) **Patent No.:** **US D701,619 S**
(45) **Date of Patent:** **** Mar. 25, 2014**

(54) **PAVER**

(75) Inventor: **Jeffrey Pacitto**, Richmond Hill (CA)

(73) Assignee: **Best Way Stone Limited**, Ontario (CA)

(**) Term: **14 Years**

(21) Appl. No.: **29/385,550**

(22) Filed: **Feb. 16, 2011**

(30) **Foreign Application Priority Data**

Jan. 24, 2011 (CA) 138841

(51) **LOC (10) Cl.** **25-01**

(52) **U.S. Cl.**
USPC **D25/113**

(58) **Field of Classification Search**
USPC D25/102-118, 138, 152, 157-162, 164;
D21/484-491, 499-504; 405/16, 284,
405/286; 52/503-505, 574, 575, 596-612;
404/27-42

See application file for complete search history.

(56) **References Cited**

U.S. PATENT DOCUMENTS

2,397,119 A * 3/1946 Bohn 52/279
3,222,840 A * 12/1965 Rosenfeld 52/561

(Continued)

FOREIGN PATENT DOCUMENTS

CA 1180218 1/1985
CA 81908 10/1997

(Continued)

OTHER PUBLICATIONS

U.S. Appl. No. 29/385,552, filed Feb. 16, 2011, Pacitto, Jeffrey.

(Continued)

Primary Examiner — Anhdao Doan

(74) *Attorney, Agent, or Firm* — Locke Lord LLP; Peter J. Fallon

(57) **CLAIM**

I claim the ornamental design for a paver, as shown and described.

DESCRIPTION

FIG. 1 is a top view of the present design.
FIG. 2 is a top view of a first variant of the paver.
FIG. 3 is a top view of a second variant of the paver.
FIG. 4 is a top view of a third variant of the paver.
FIG. 5 is a top view of a fourth variant of the paver.
FIG. 6 is a top view of a fifth variant of the paver.
FIG. 7 is a top view of a sixth variant of the paver.
FIG. 8 is a perspective view of the paver of FIG. 1.
FIG. 9 is a perspective view of the paver of FIG. 2.
FIG. 10 is a perspective view of the paver of FIG. 3.
FIG. 11 is a perspective view of the paver of FIG. 4.
FIG. 12 is a perspective view of the paver of FIG. 5.
FIG. 13 is a perspective view of the paver of FIG. 6.
FIG. 14 is a perspective view of the paver of FIG. 7.
FIG. 15 is a left view of the paver of FIGS. 1, 3 and 6.
FIG. 16 is a back view of the paver of FIGS. 1, 6 and 7.
FIG. 17 is a right view of the paver of FIGS. 1, 3 and 6.
FIG. 18 is a front view of the paver of FIGS. 1 and 7.
FIG. 19 is a left view of the paver of FIG. 2.
FIG. 20 is a back view of the paver of FIGS. 2, 3, 4 and 5.
FIG. 21 is a right view of the paver of FIG. 2.
FIG. 22 is a front view of the paver of FIGS. 2, 3, 4 and 5.
FIG. 23 is a left view of the paver of FIG. 4.
FIG. 24 is a right view of the paver of FIG. 4.
FIG. 25 is a left view of the paver of FIG. 5.
FIG. 26 is a right view of the paver of FIG. 5.
FIG. 27 is a front view of the paver of FIG. 6.
FIG. 28 is a left view of the paver of FIG. 7.
FIG. 29 is a right view of the paver of FIG. 7; and,
FIG. 30 is a bottom view of the paver of FIGS. 1, 2, 3, 4, 5, 6 and 7.

1 Claim, 23 Drawing Sheets

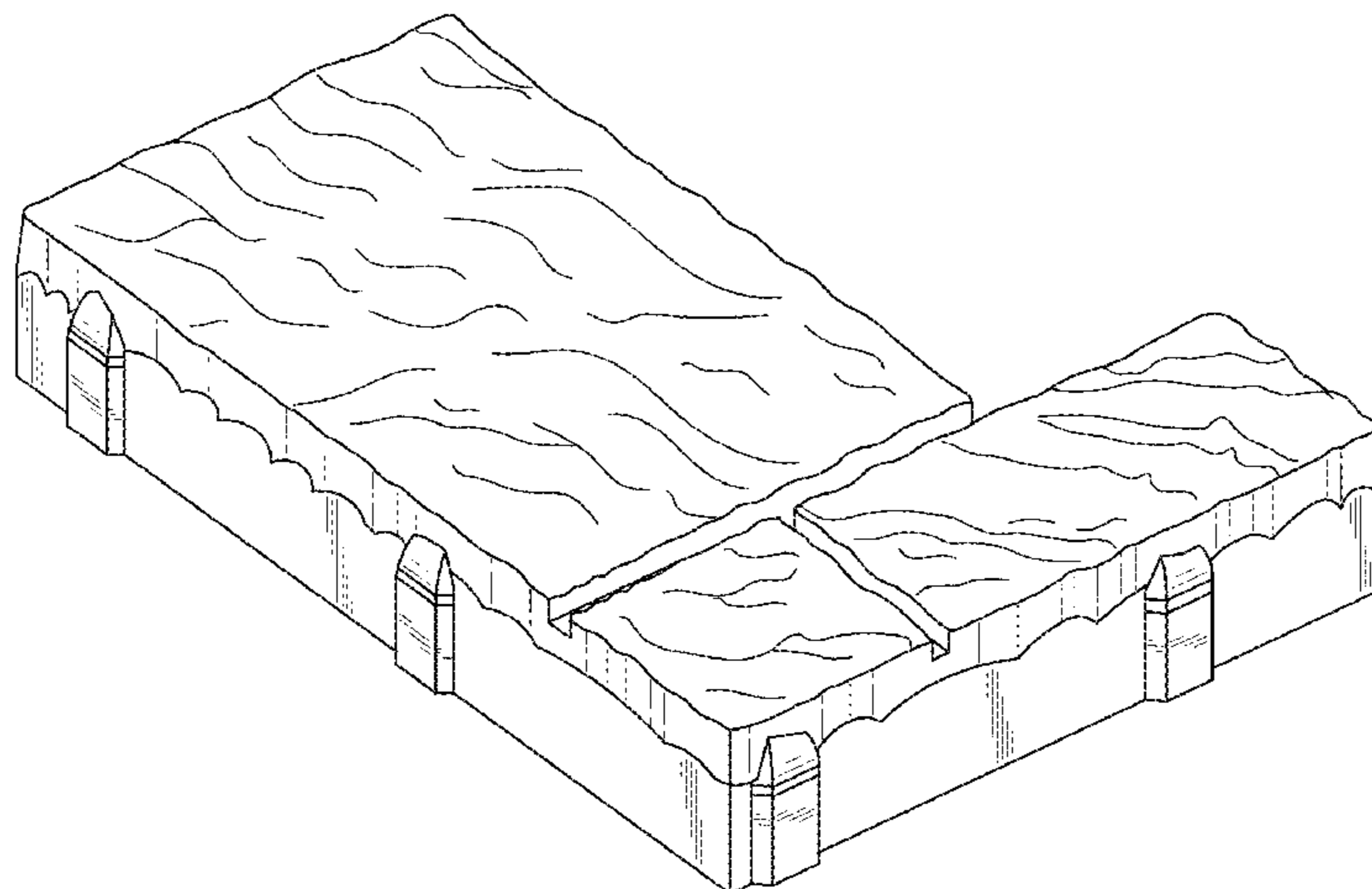

(56)

References Cited

U.S. PATENT DOCUMENTS

| | | | | |
|--------------|-----|---------|-------------------|---------|
| 5,496,129 | A * | 3/1996 | Dube | 404/29 |
| D389,926 | S * | 1/1998 | Barth et al. | D25/113 |
| D425,628 | S * | 5/2000 | Barth et al. | D25/113 |
| 6,055,784 | A * | 5/2000 | Geiger | 52/603 |
| D442,703 | S * | 5/2001 | Fifield | D25/113 |
| D498,543 | S * | 11/2004 | Schmitz et al. | D25/113 |
| D505,733 | S * | 5/2005 | Castonguay et al. | D25/113 |
| D639,454 | S * | 6/2011 | Thomassen | D25/113 |
| D660,983 | S * | 5/2012 | Thomassen | D25/113 |
| 2008/0240857 | A1 | 10/2008 | Ciccarello | |

FOREIGN PATENT DOCUMENTS

| | | |
|----|---------|--------|
| CA | 2669426 | 8/2002 |
| CA | 95294 | 1/2006 |

| | | |
|----|-----------|---------|
| CA | 97272 | 1/2006 |
| CA | 109688 | 1/2006 |
| CA | 2550358 | 12/2007 |
| CA | 121170 | 4/2008 |
| CA | 131922 | 12/2009 |
| CA | 130858 | 10/2010 |
| DE | 1790054 | 6/1959 |
| DE | 1116695 | 11/1961 |
| FR | 870037 | 2/1942 |
| FR | 2252467 | 6/1975 |
| GB | 2184143 A | 6/1987 |

OTHER PUBLICATIONS

Unilock Designed to Connect website: <http://www.unilock.com/products/>.

Infento Inc.—Licensees website: <http://infento.com/licensees.html>.

* cited by examiner

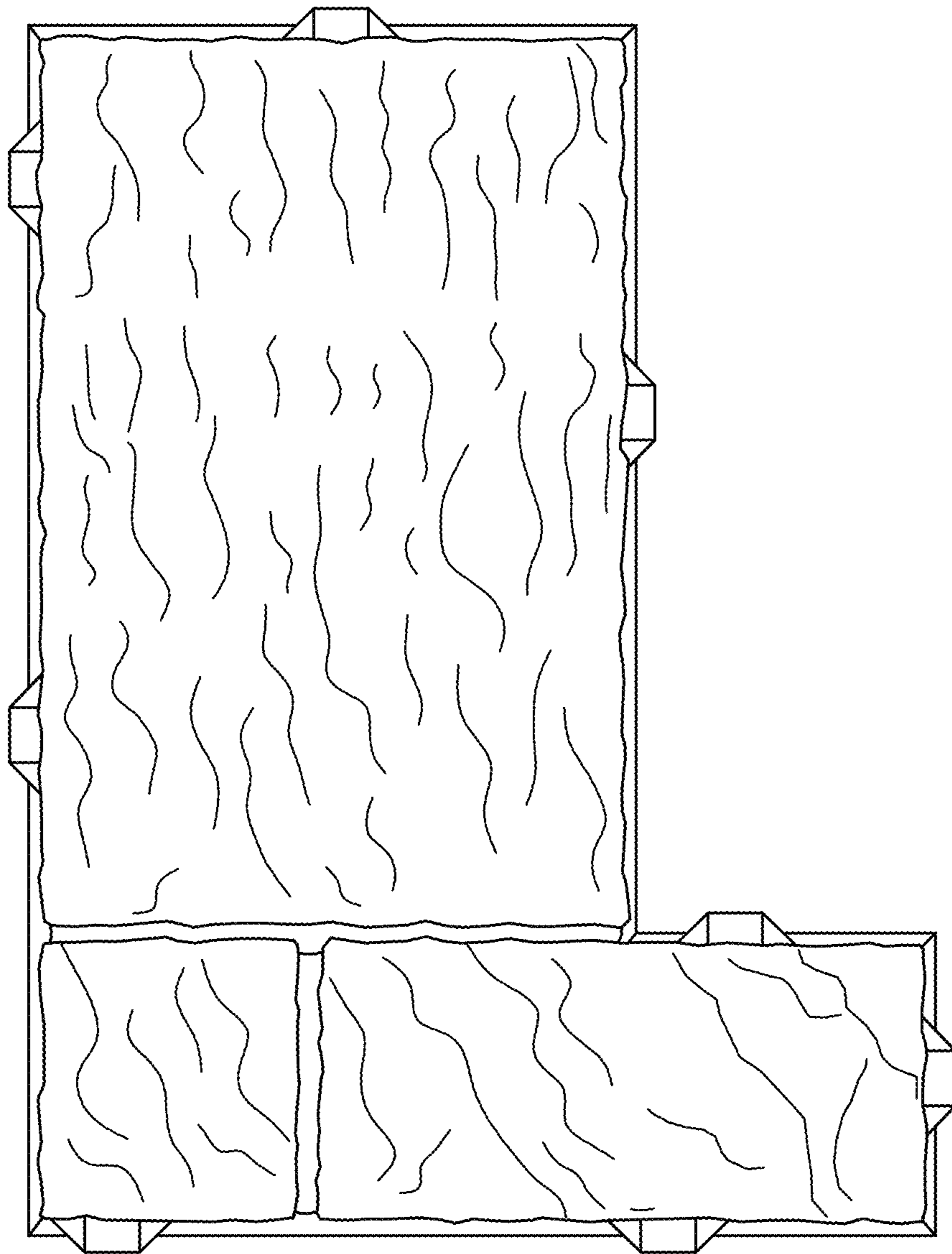

Figure 1

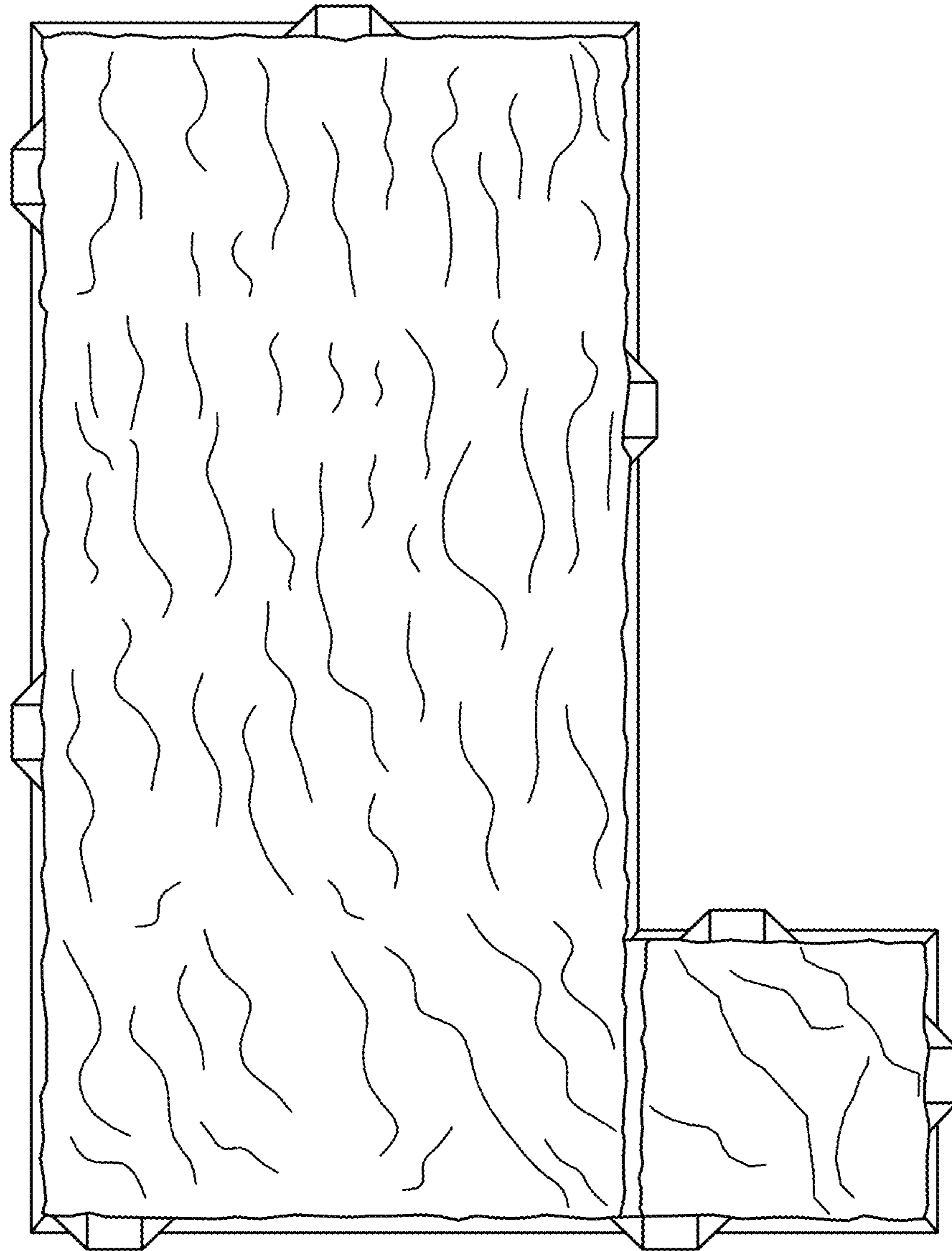

Figure 2

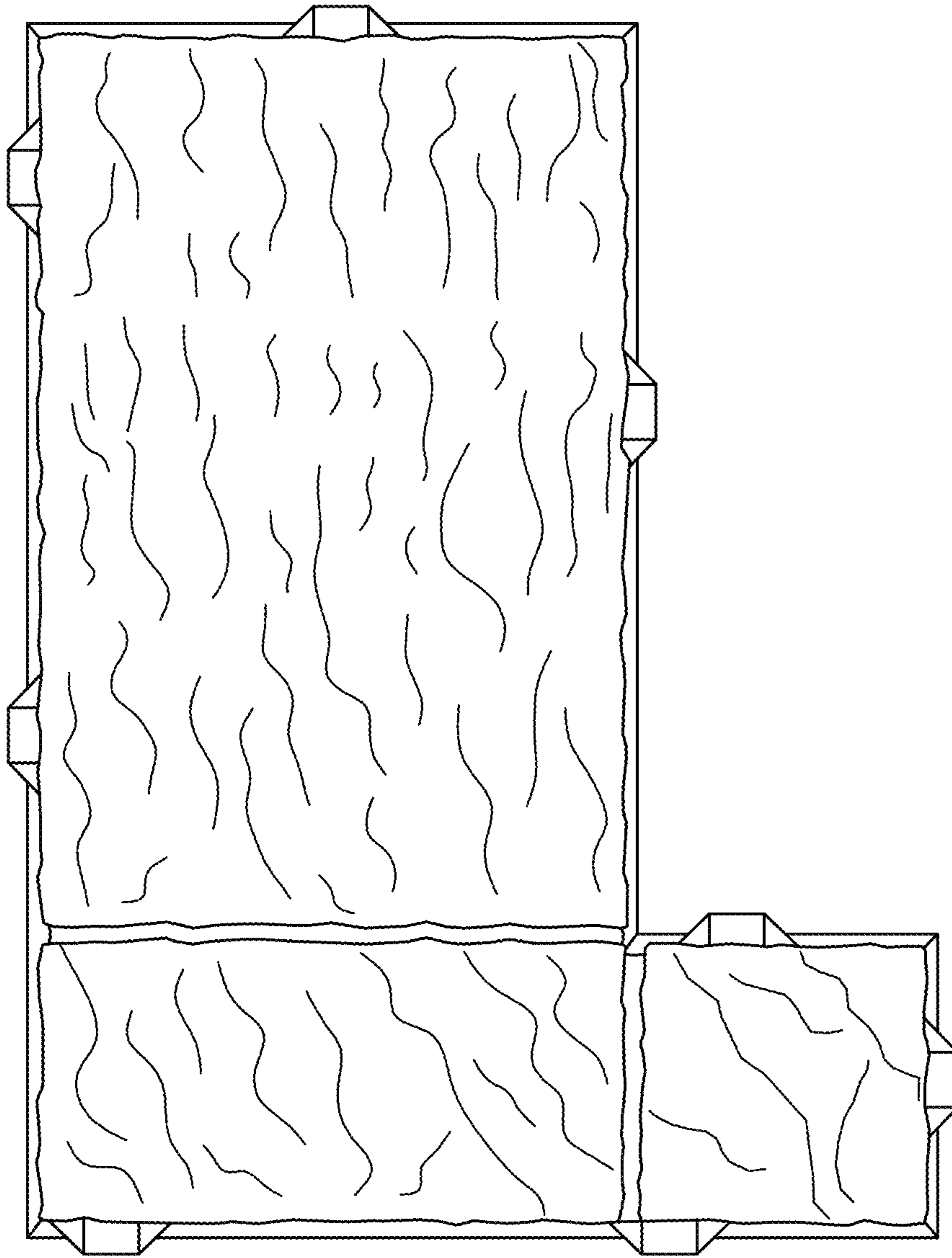

Figure 3

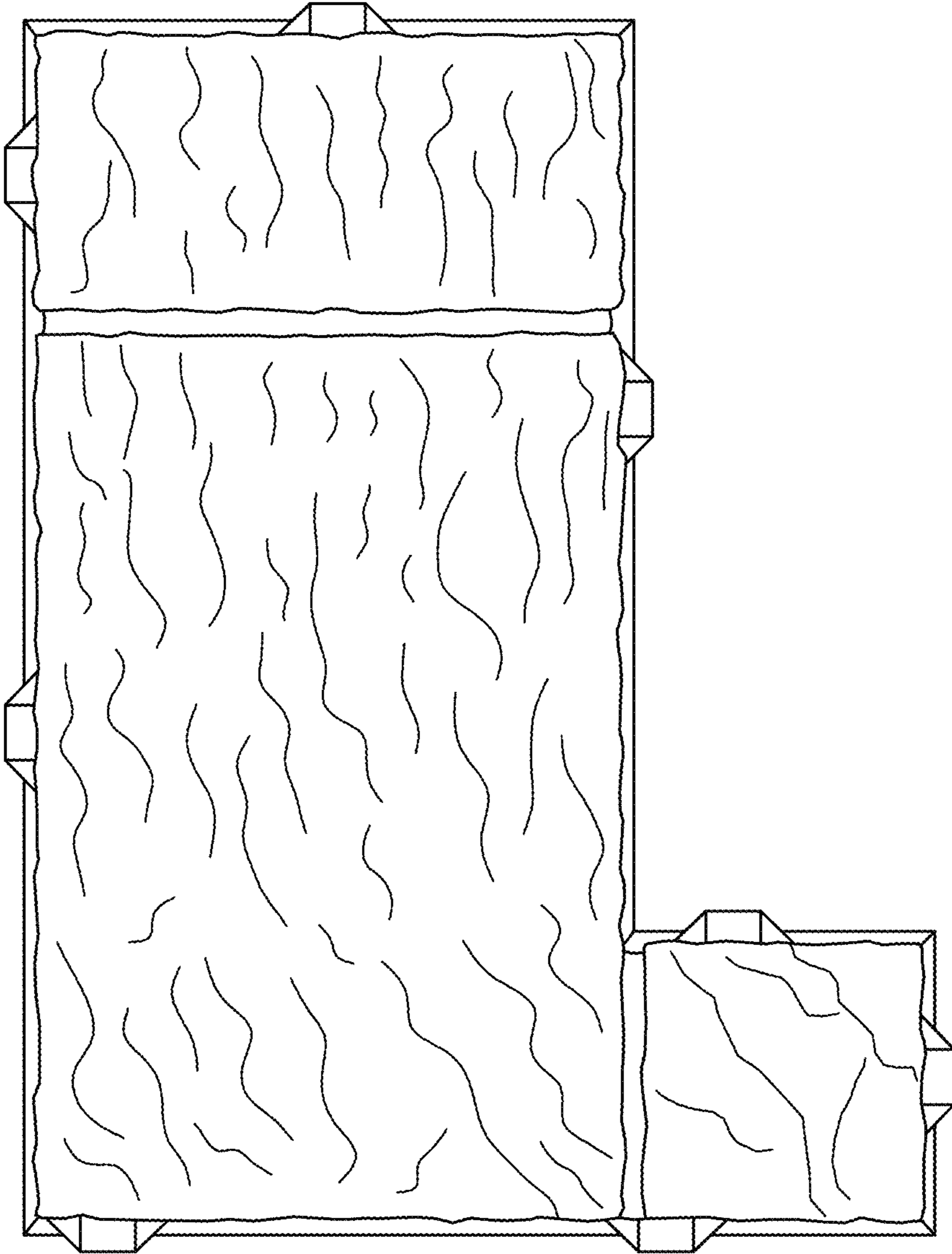

Figure 4

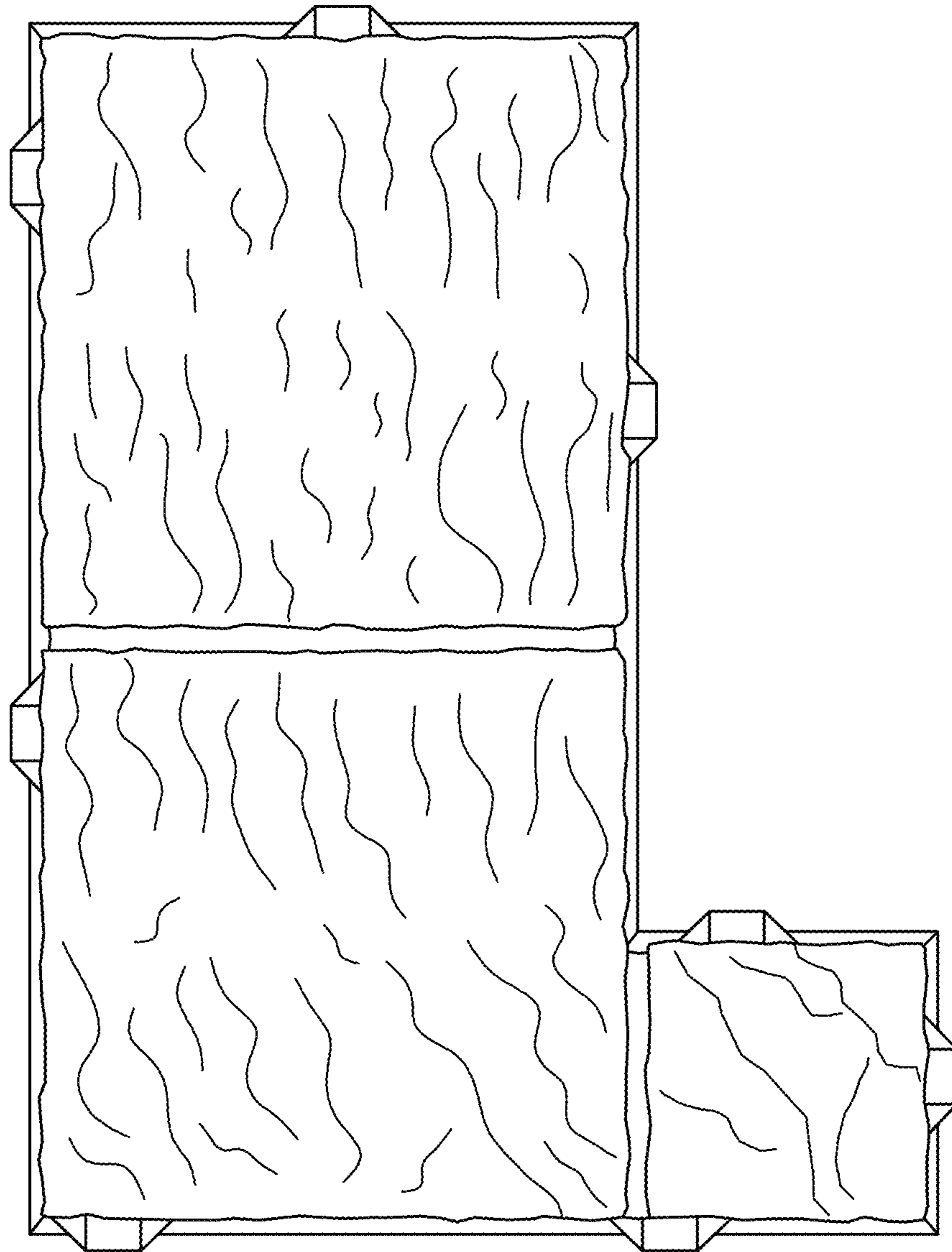

Figure 5

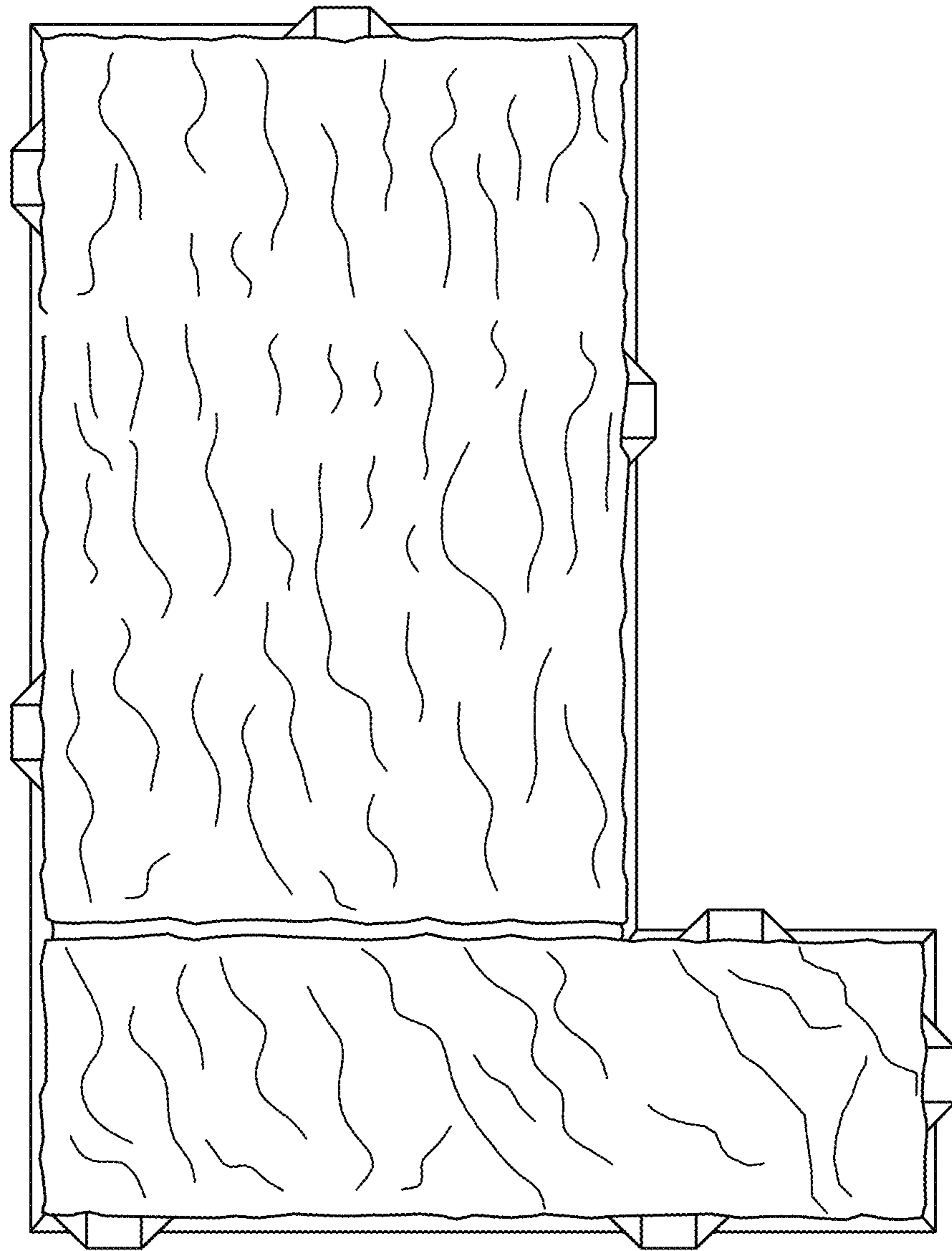

Figure 6

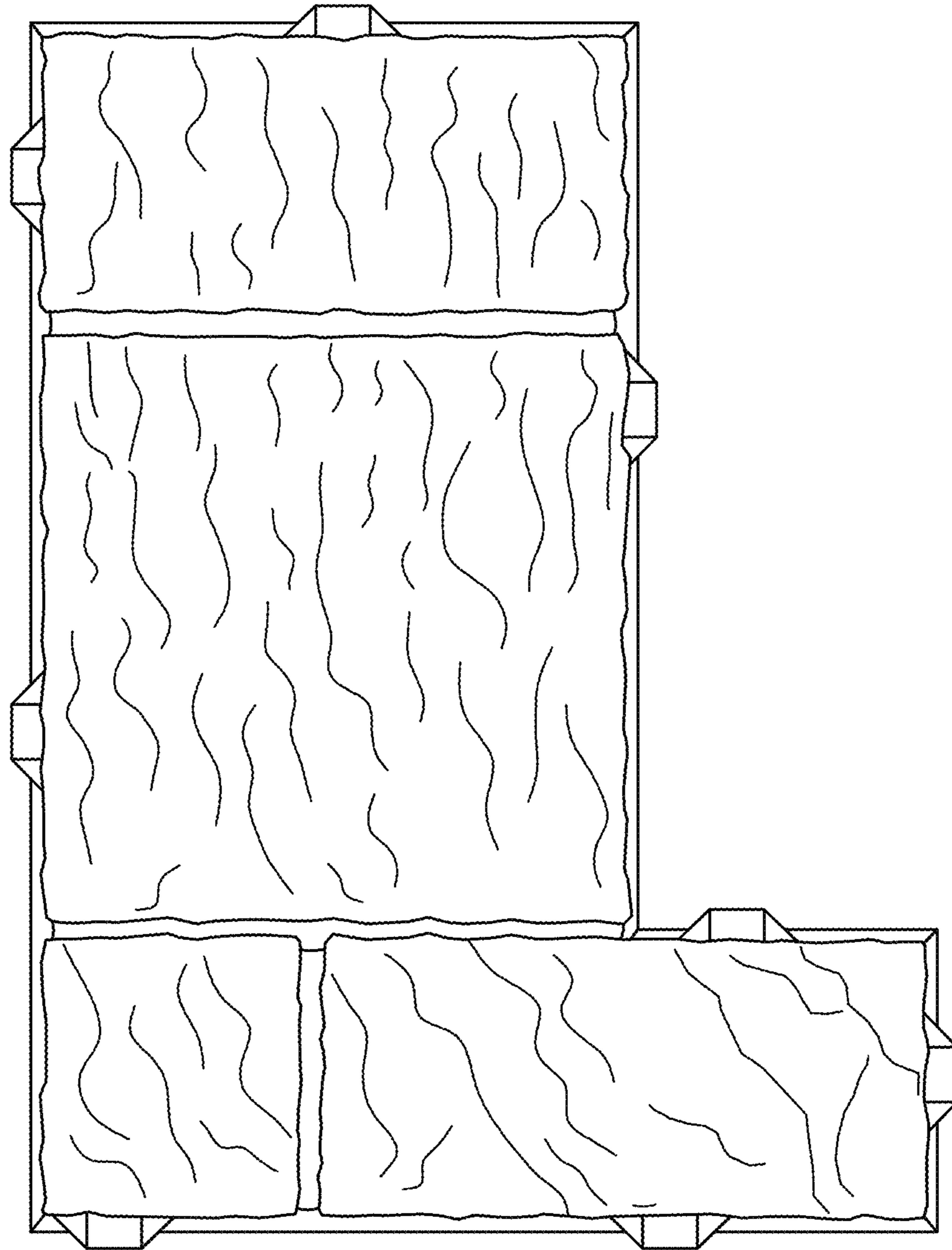

Figure 7

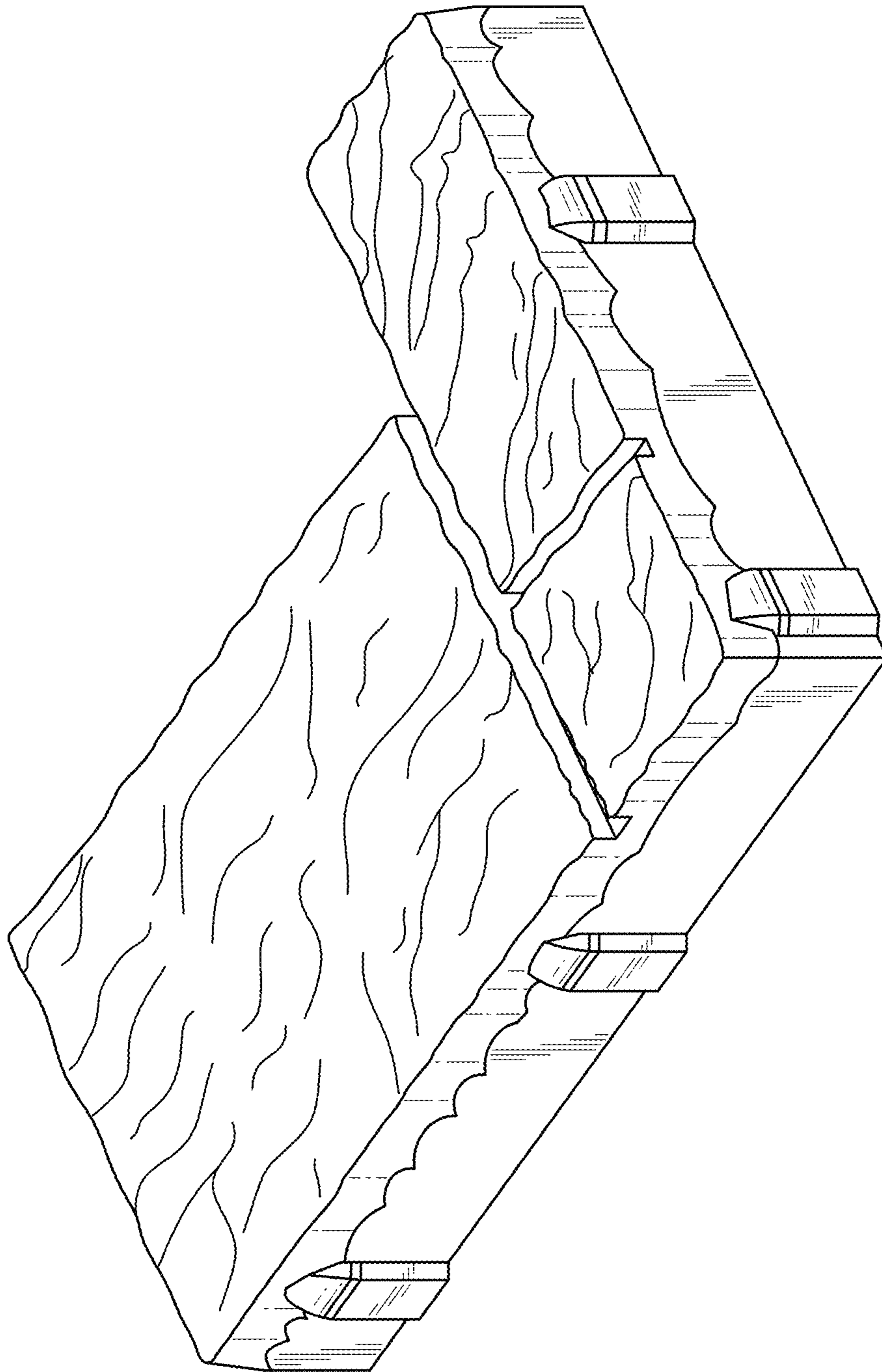

Figure 8

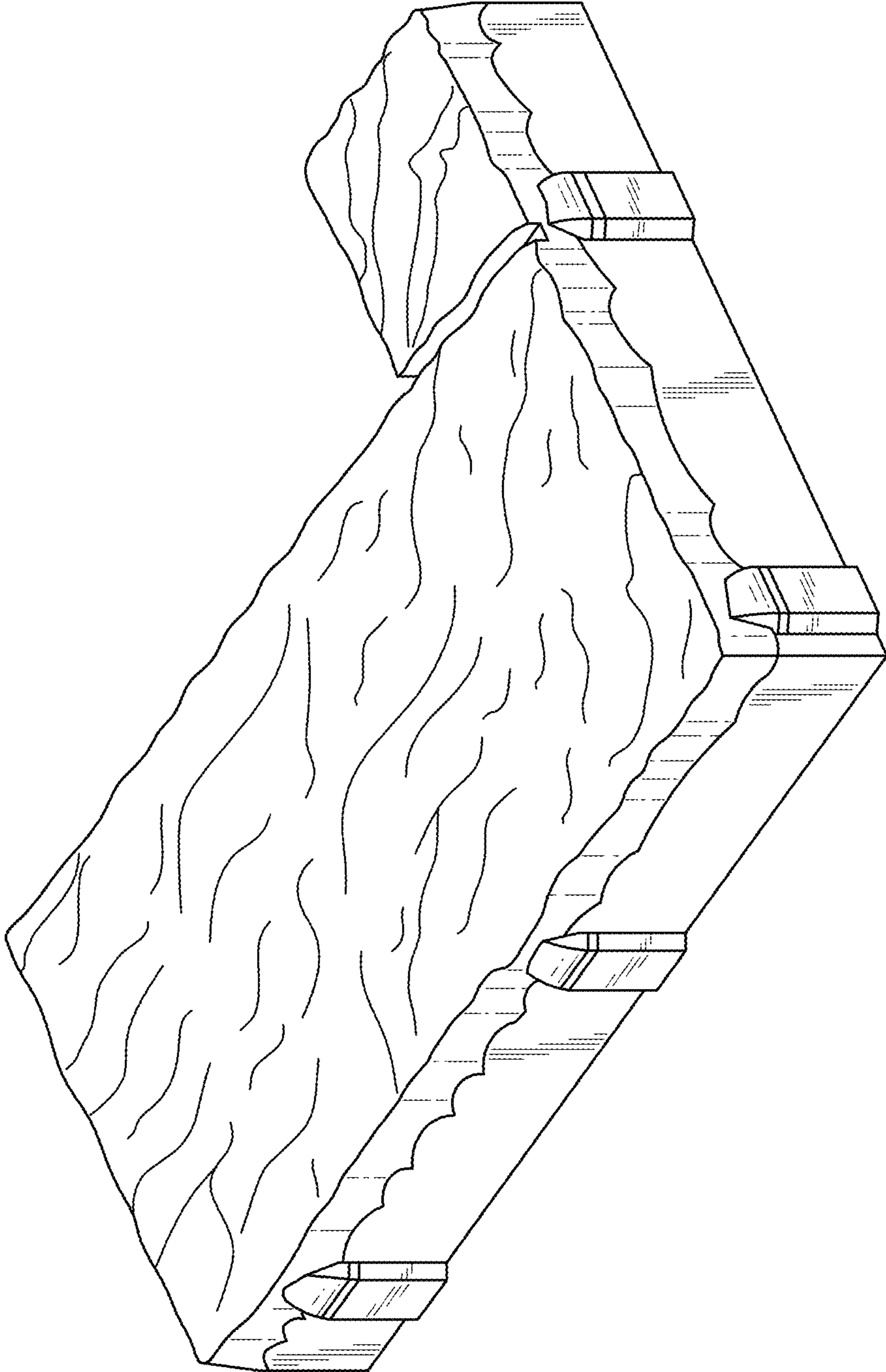

Figure 9

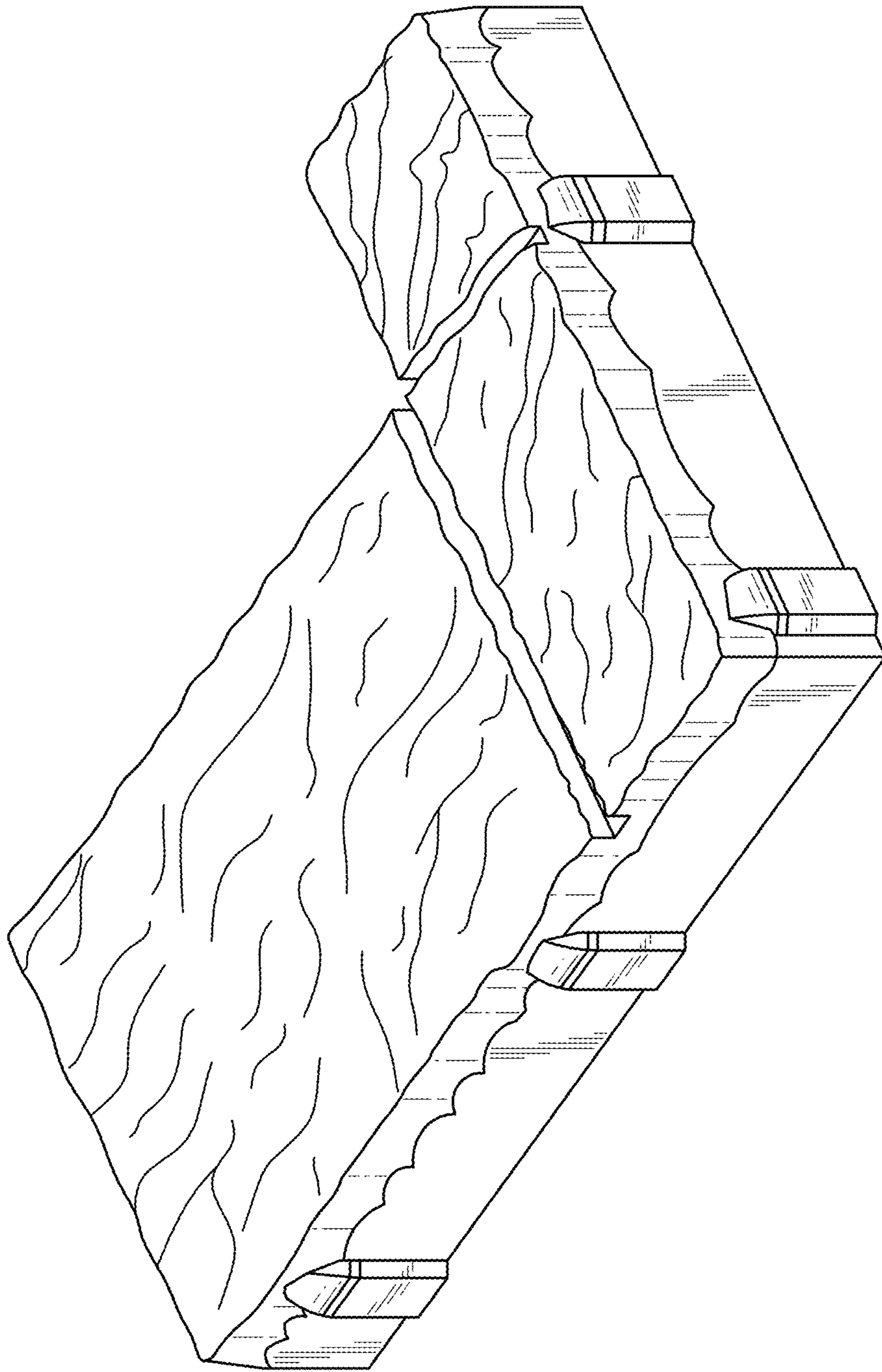

Figure 10

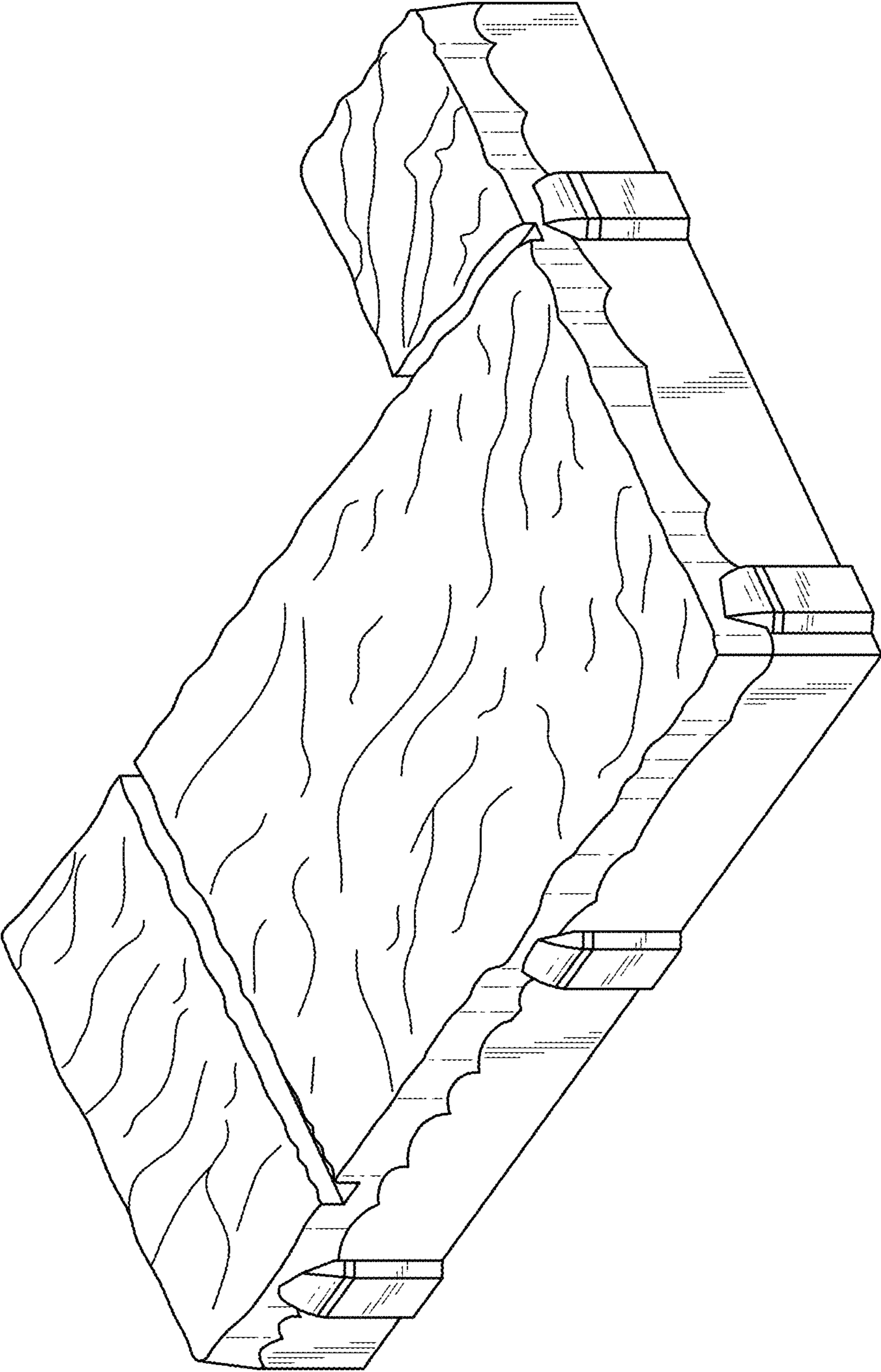

Figure 11

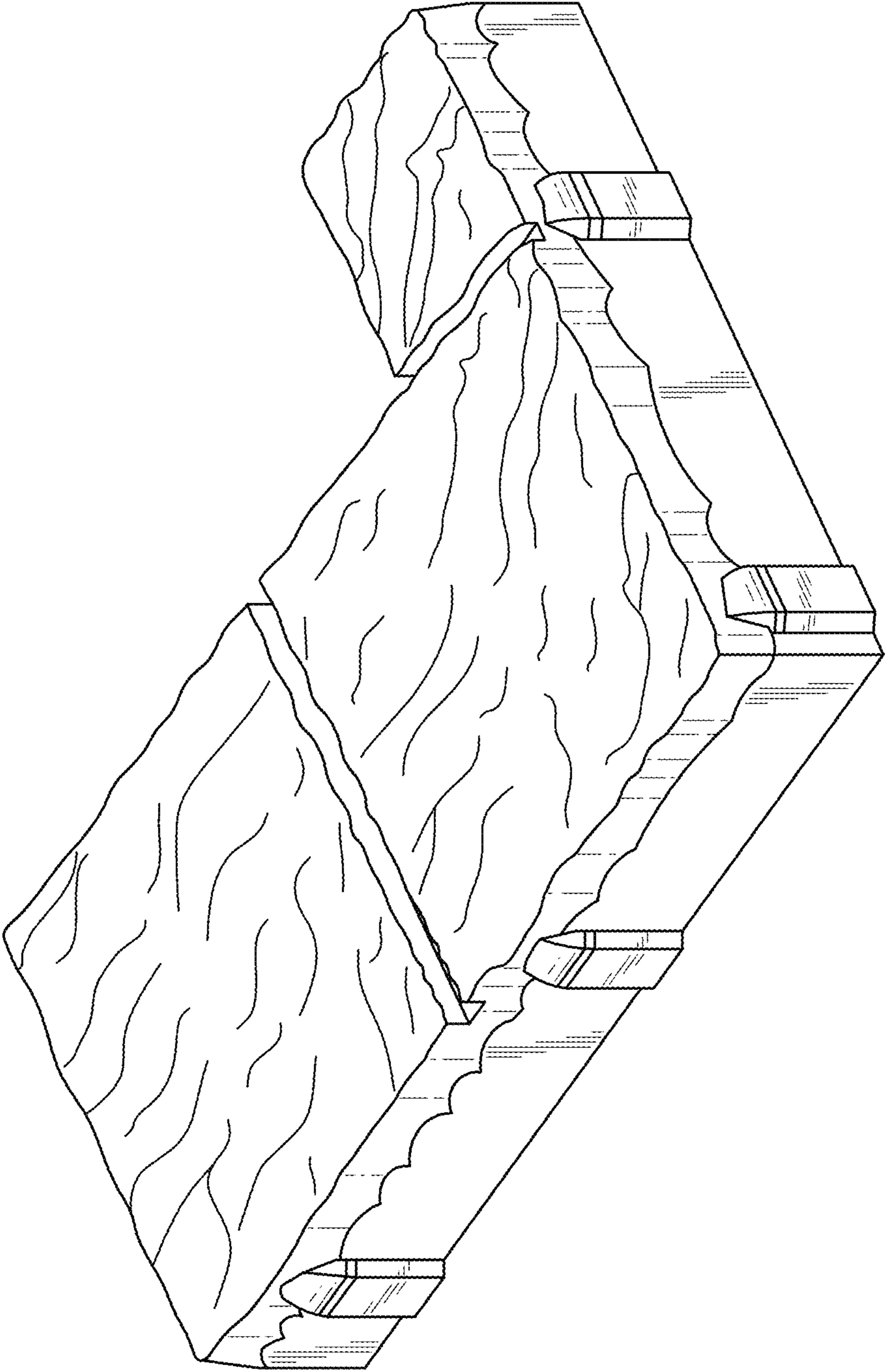

Figure 12

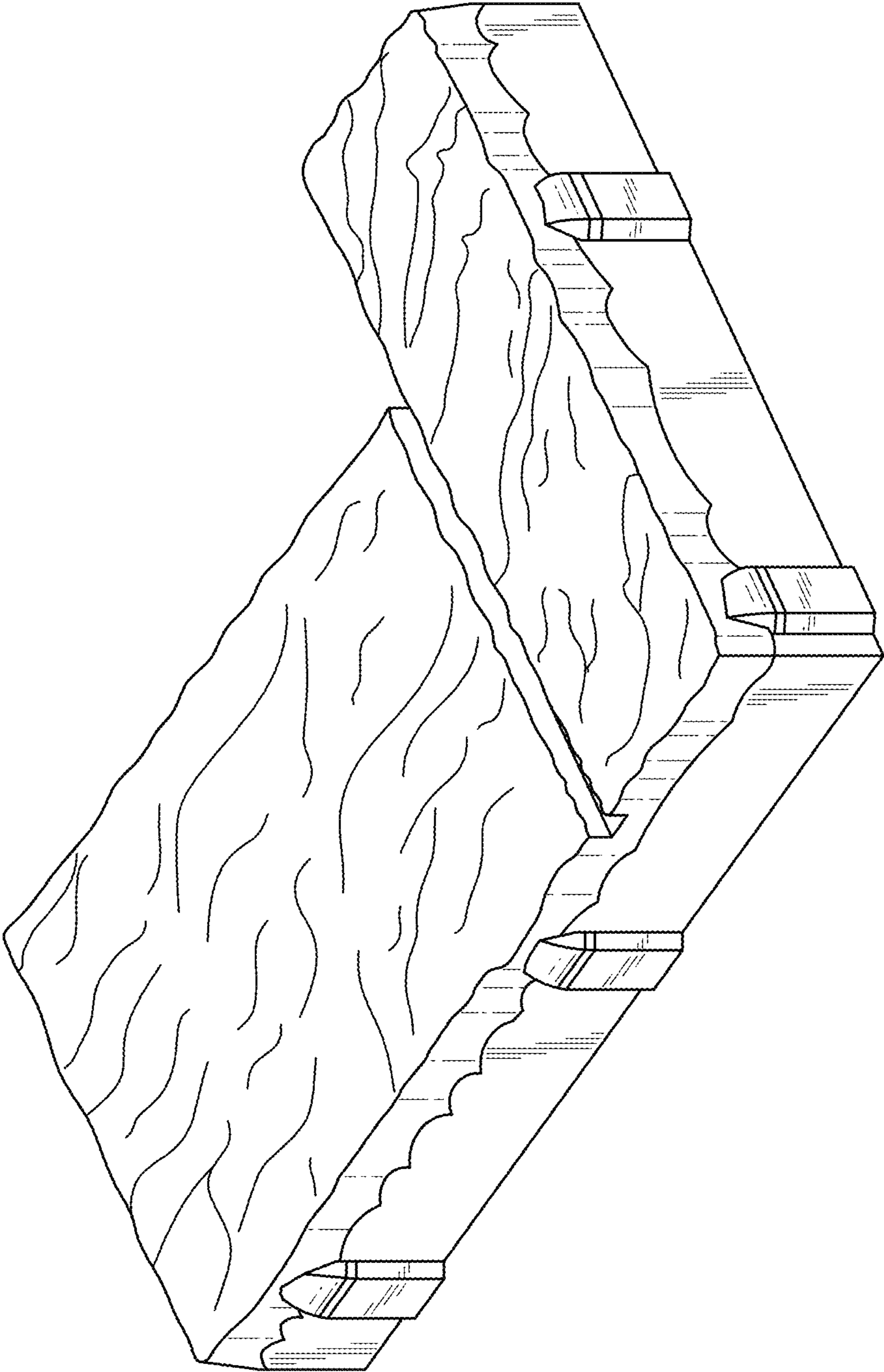

Figure 13

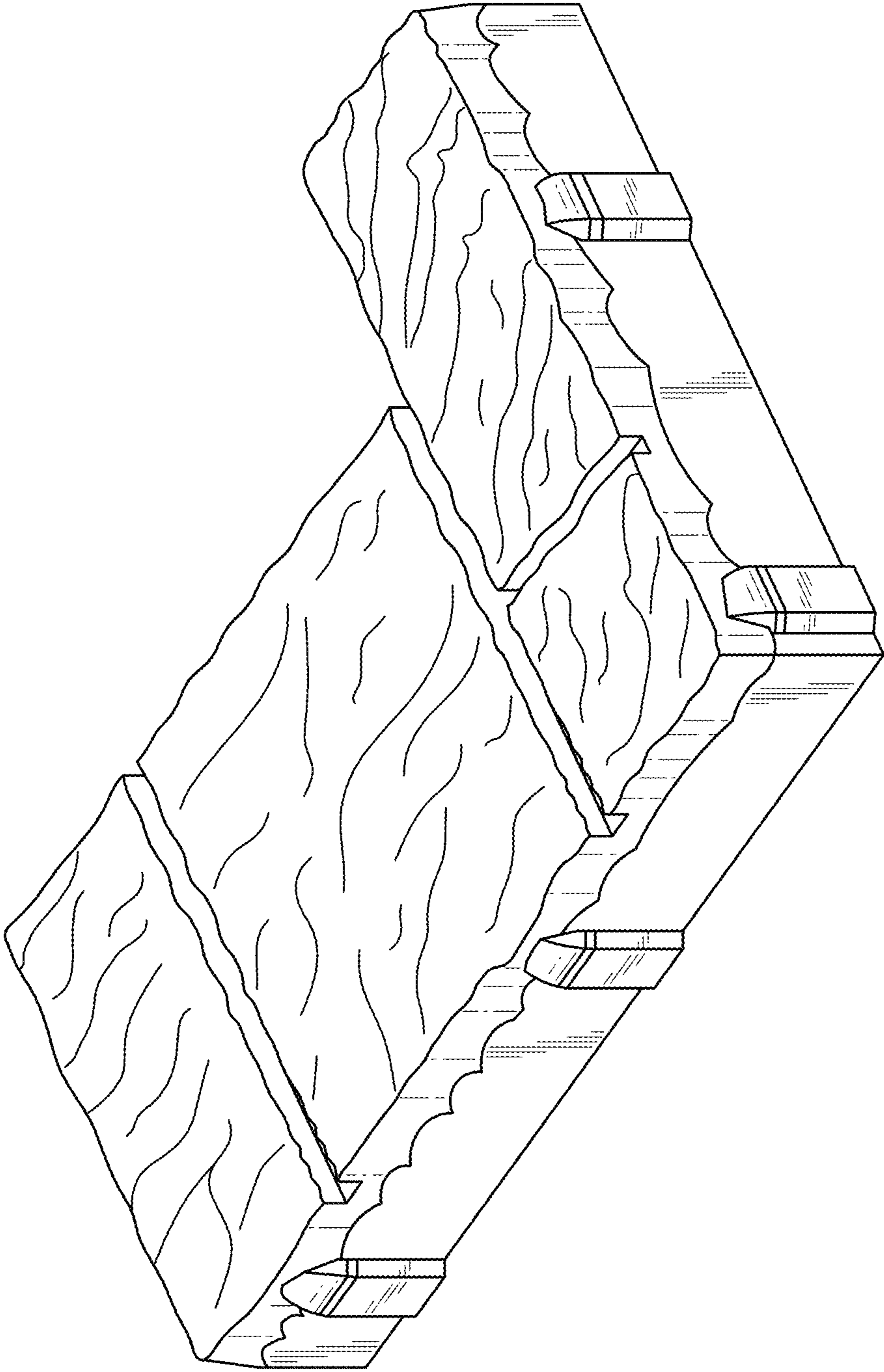

Figure 14

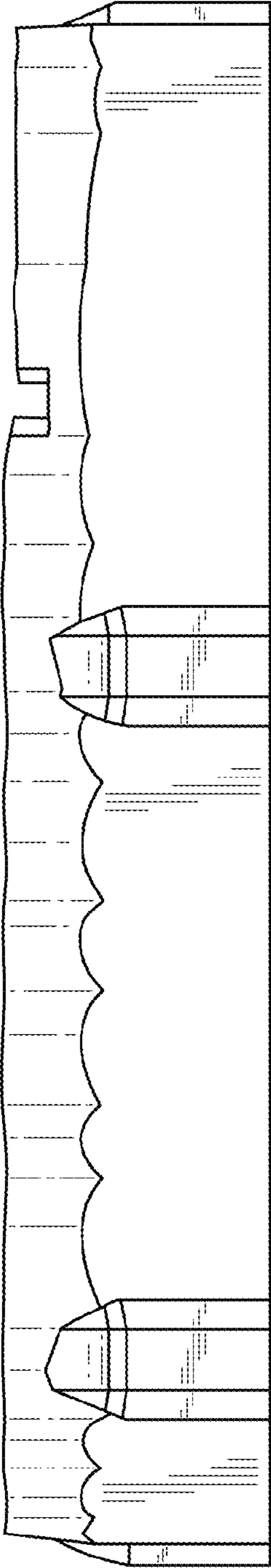

Figure 15

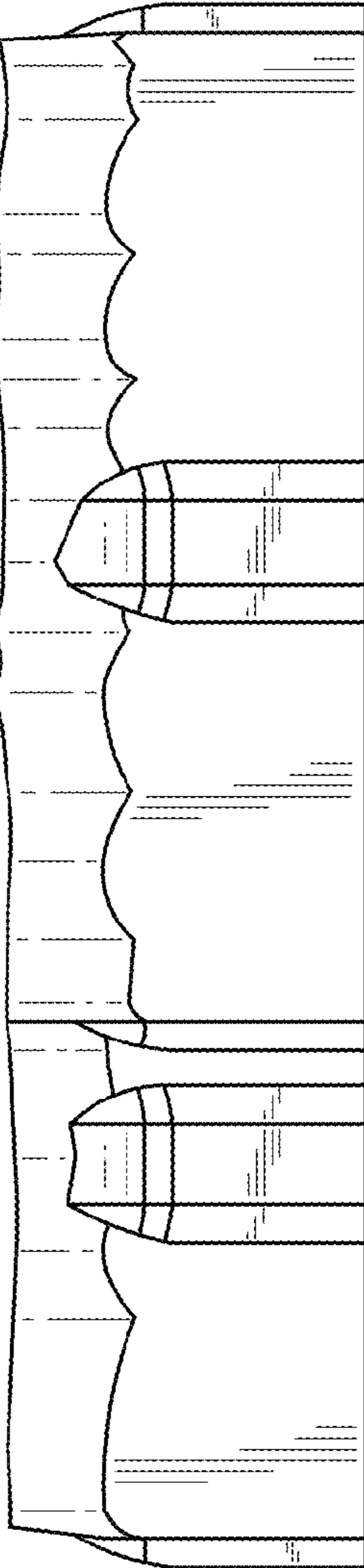

Figure 16

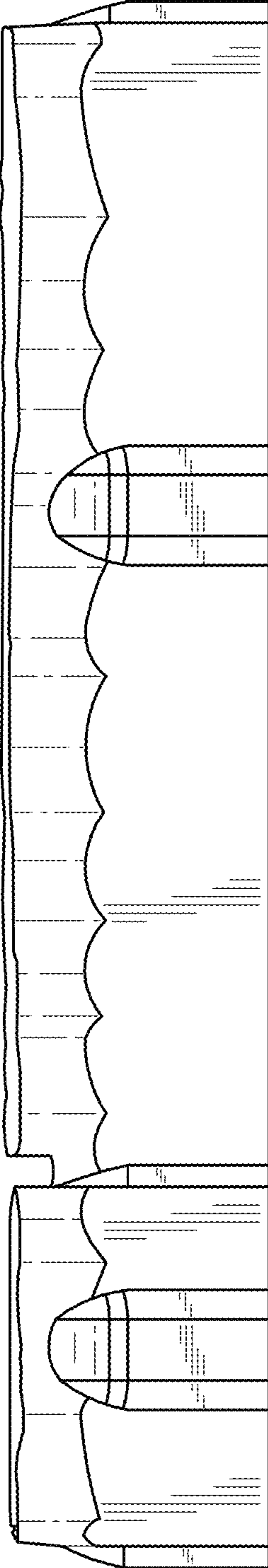

Figure 17

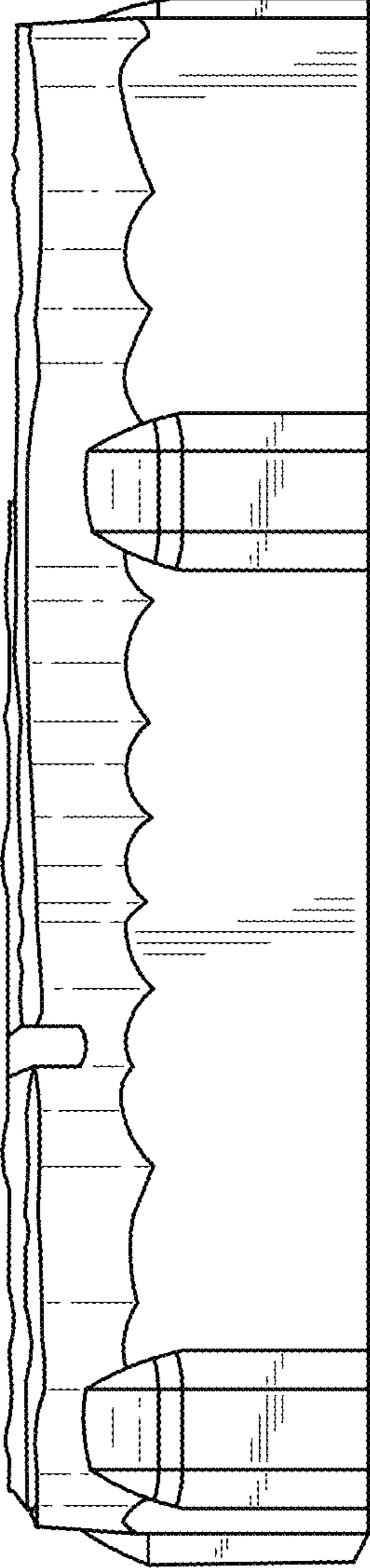

Figure 18

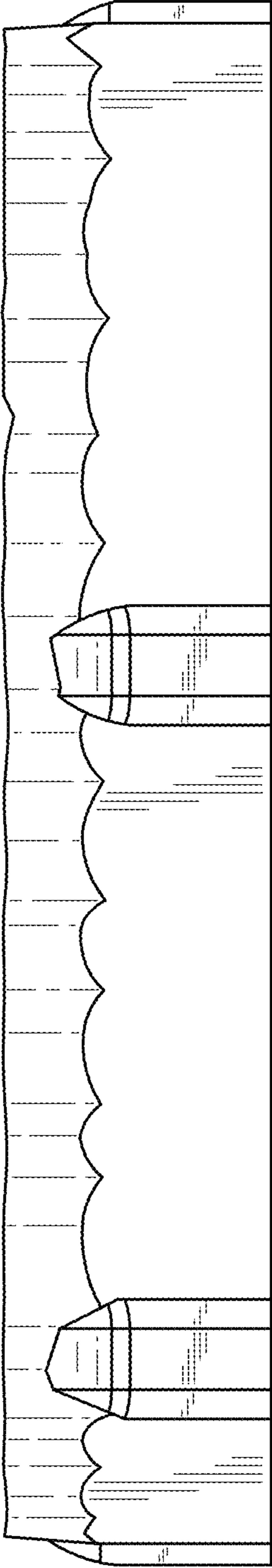

Figure 19

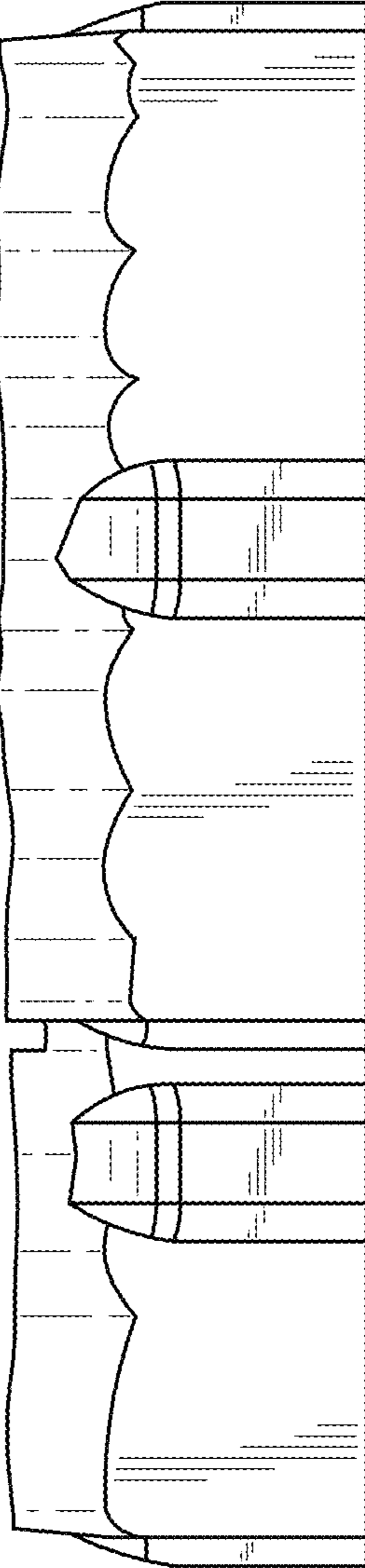

Figure 20

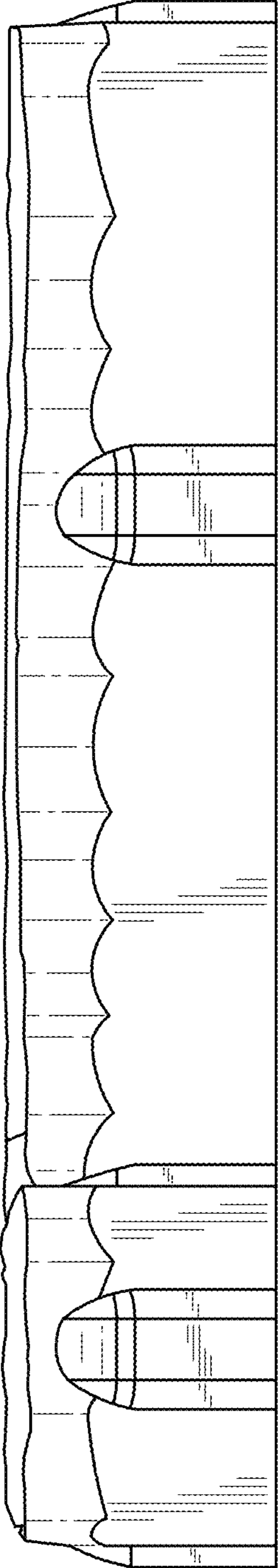

Figure 21

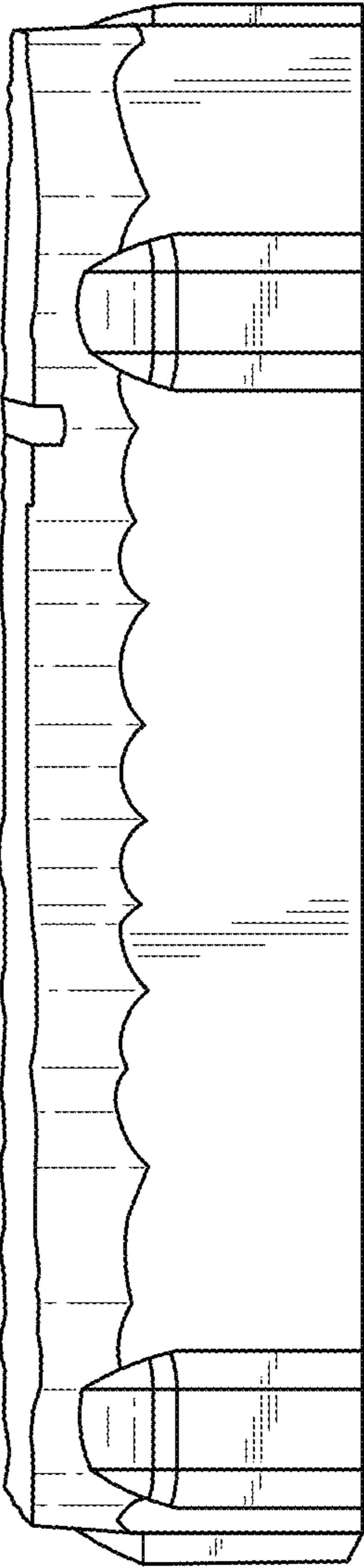

Figure 22

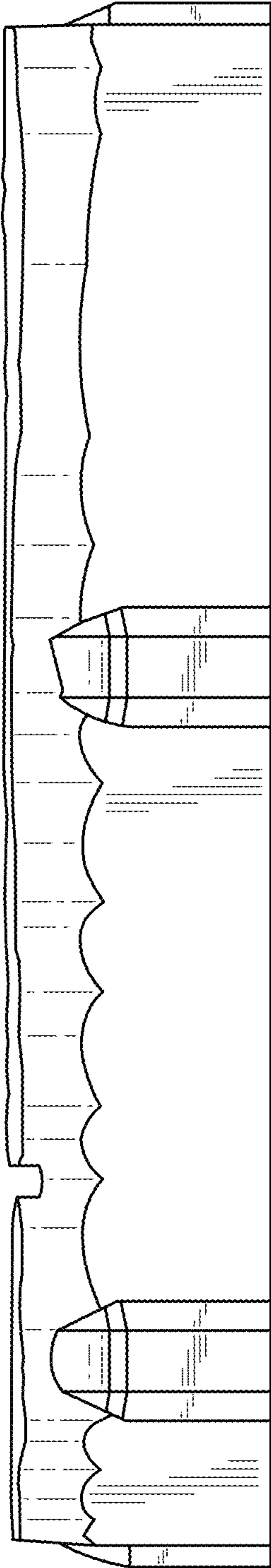

Figure 23

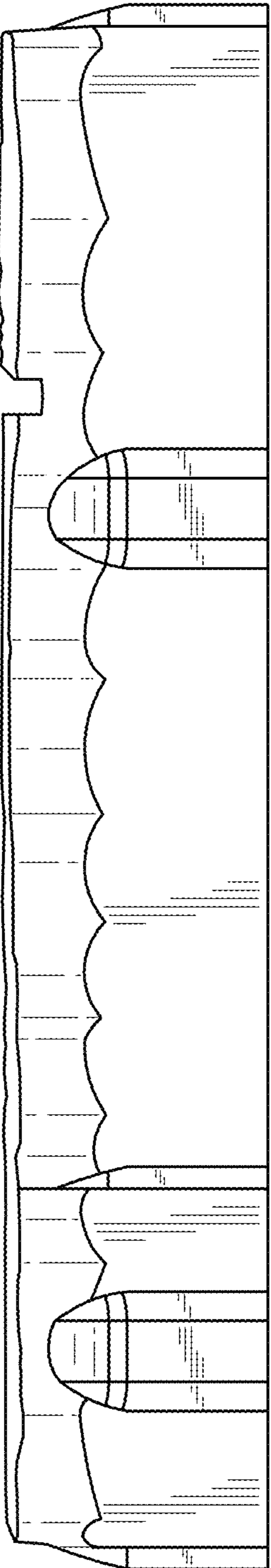

Figure 24

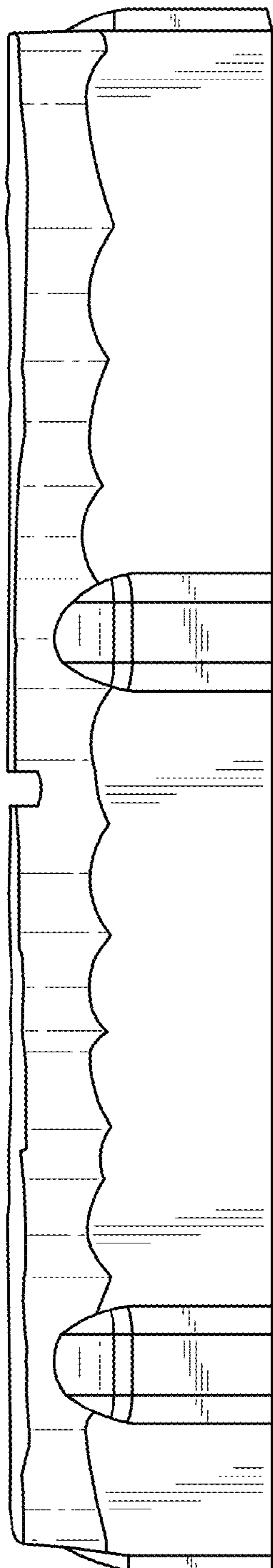

Figure 25

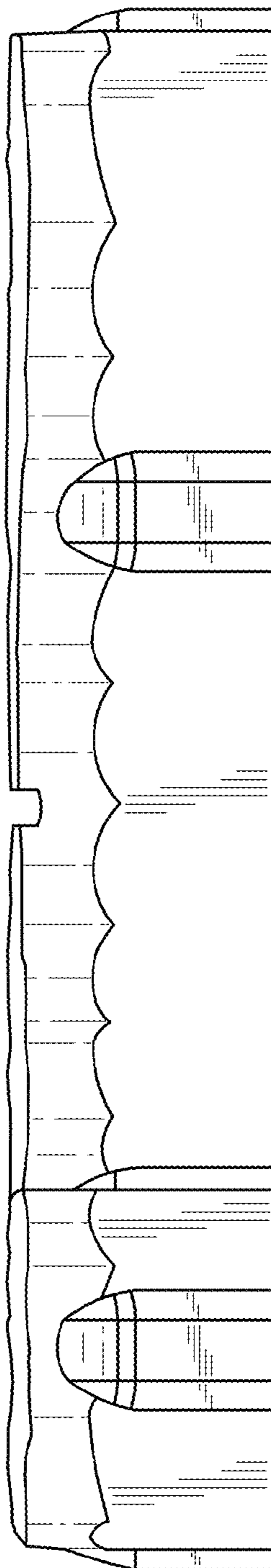

Figure 26

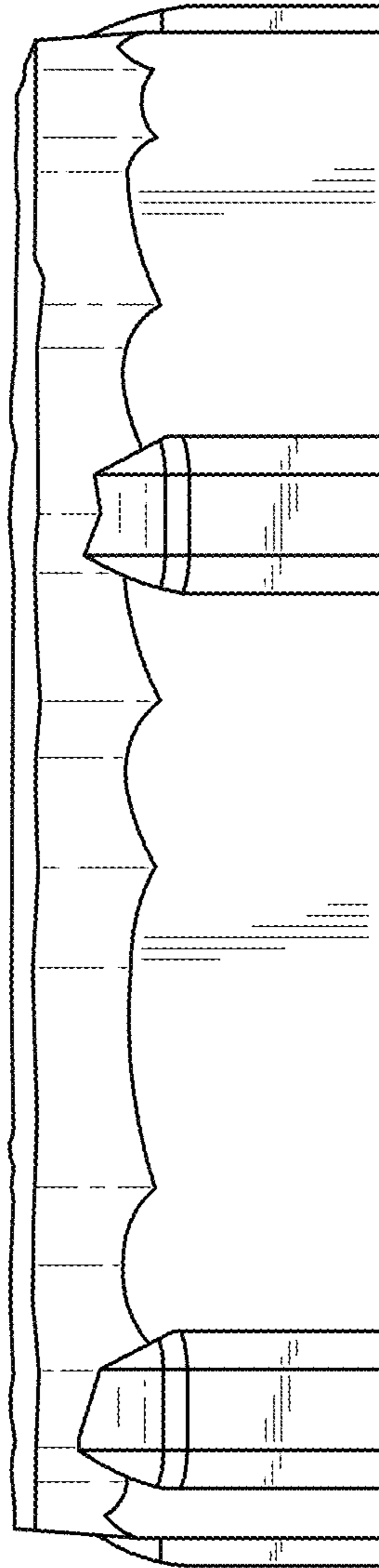

Figure 27

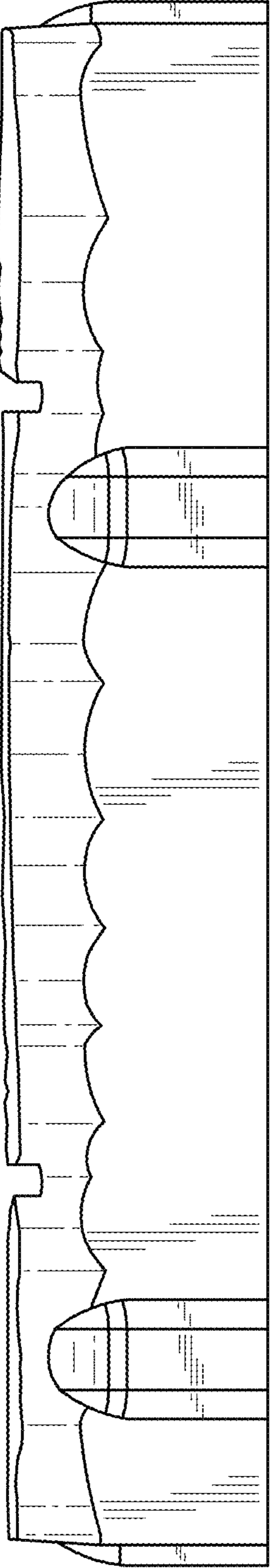

Figure 28

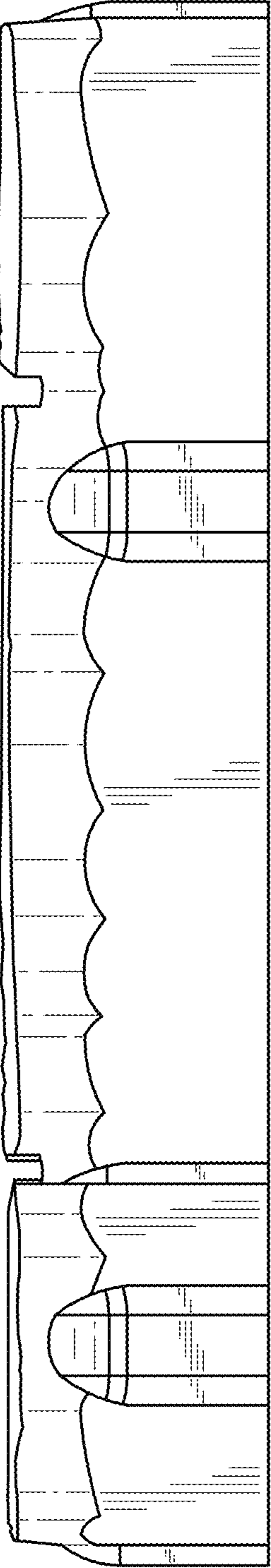

Figure 29

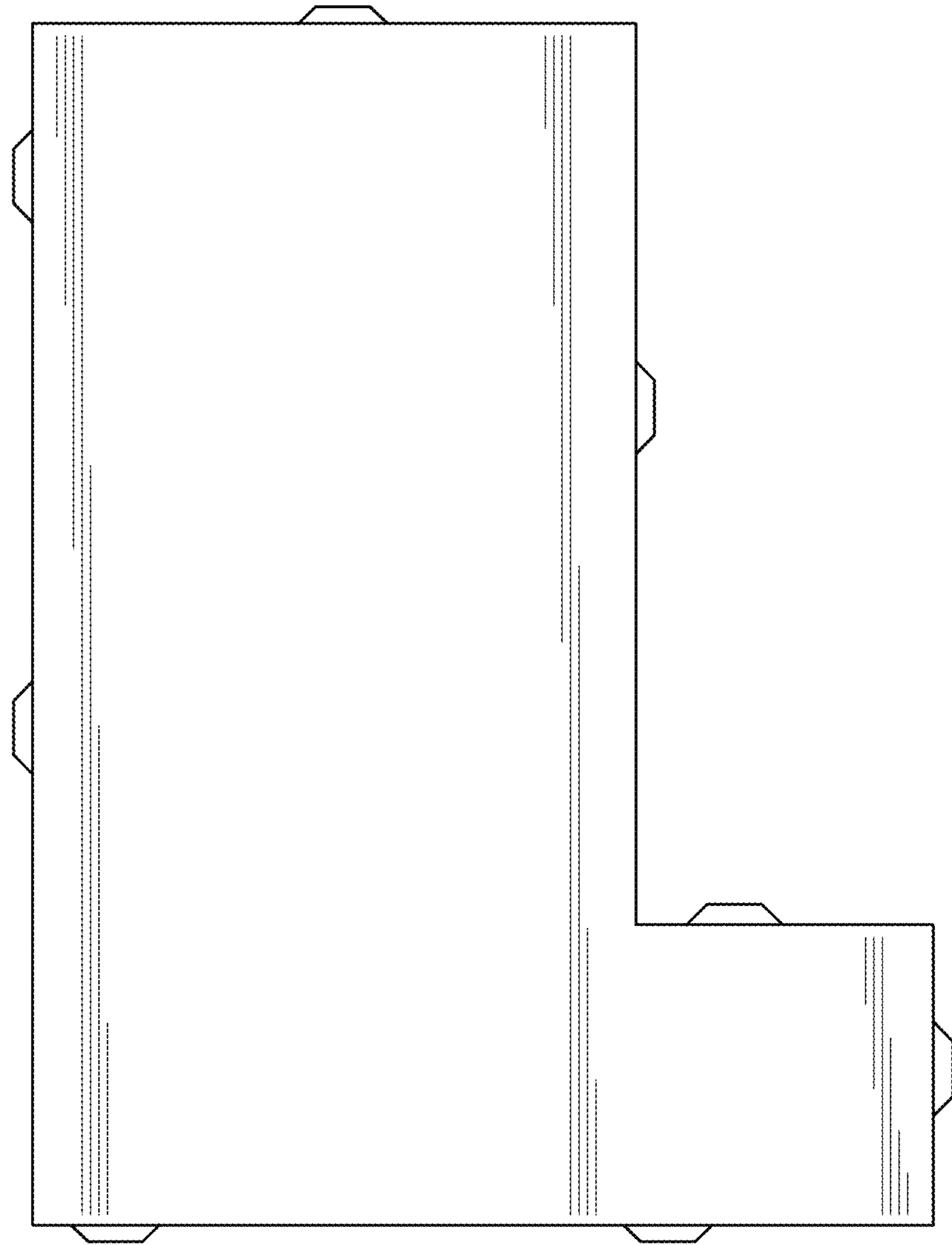

Figure 30