



US00D701596S

(12) **United States Design Patent**
Yoo et al.

(10) **Patent No.:** **US D701,596 S**
(45) **Date of Patent:** **** Mar. 25, 2014**

(54) **AIR CONDITIONER**

(71) Applicant: **LG Electronics Inc.**, Seoul (KR)

(72) Inventors: **Joonggil Yoo**, Gyeonggi-do (KR); **Ilseop So**, Seoul (KR); **Eugene Suh**, Seoul (KR); **Sangyoon Lee**, Gyeonggi-do (KR)

(73) Assignee: **LG Electronics Inc.**, Seoul (KR)

(**) Term: **14 Years**

(21) Appl. No.: **29/461,047**

(22) Filed: **Jul. 18, 2013**

(30) **Foreign Application Priority Data**

Jan. 21, 2013 (KR) 30-2013-0003312

(51) **LOC (10) Cl.** **23-04**

(52) **U.S. Cl.**
USPC **D23/351**

(58) **Field of Classification Search**
USPC D23/314, 317, 332-333, 351; 312/236;
62/259.1, 259.3, 259.4, 262-263, 304,
62/401, 515-516; 454/330-331, 349-350,
454/354

See application file for complete search history.

(56) **References Cited**

U.S. PATENT DOCUMENTS

D454,187 S * 3/2002 Wang et al. D23/351
D547,849 S * 7/2007 Francisquini D23/351
D557,782 S * 12/2007 Choi D23/351
D580,031 S * 11/2008 Kim et al. D23/351
D580,032 S * 11/2008 Kim et al. D23/351

D683,005 S * 5/2013 Park et al. D23/351
D689,993 S * 9/2013 Yoon et al. D23/351
D689,994 S * 9/2013 Jun et al. D23/351

* cited by examiner

Primary Examiner — Brian N Vinson

(74) *Attorney, Agent, or Firm* — Morgan, Lewis & Bockius LLP

(57) **CLAIM**

The ornamental design for an air conditioner, as shown and described.

DESCRIPTION

FIG. 1 is a top, front, and right side perspective view of an air conditioner showing our new design;
FIG. 2 is a front elevational view thereof;
FIG. 3 is a rear elevational view thereof;
FIG. 4 is a left side elevational view thereof;
FIG. 5 is a right side elevational view thereof;
FIG. 6 is a top plan view thereof;
FIG. 7 is a bottom plan view thereof;
FIG. 8 is an additional top, front, and right side perspective view thereof, showing one state of operation;
FIG. 9 is a front elevational view of FIG. 8;
FIG. 10 is an additional top, front, and right side perspective view thereof, showing another state of operation;
FIG. 11 is a front elevational view of FIG. 10;
FIG. 12 is a left side elevational view of FIG. 10;
FIG. 13 is a right side elevational view of FIG. 10;
FIG. 14 is a top plan view of FIG. 10; and,
FIG. 15 is a bottom plan view of FIG. 10.

1 Claim, 13 Drawing Sheets

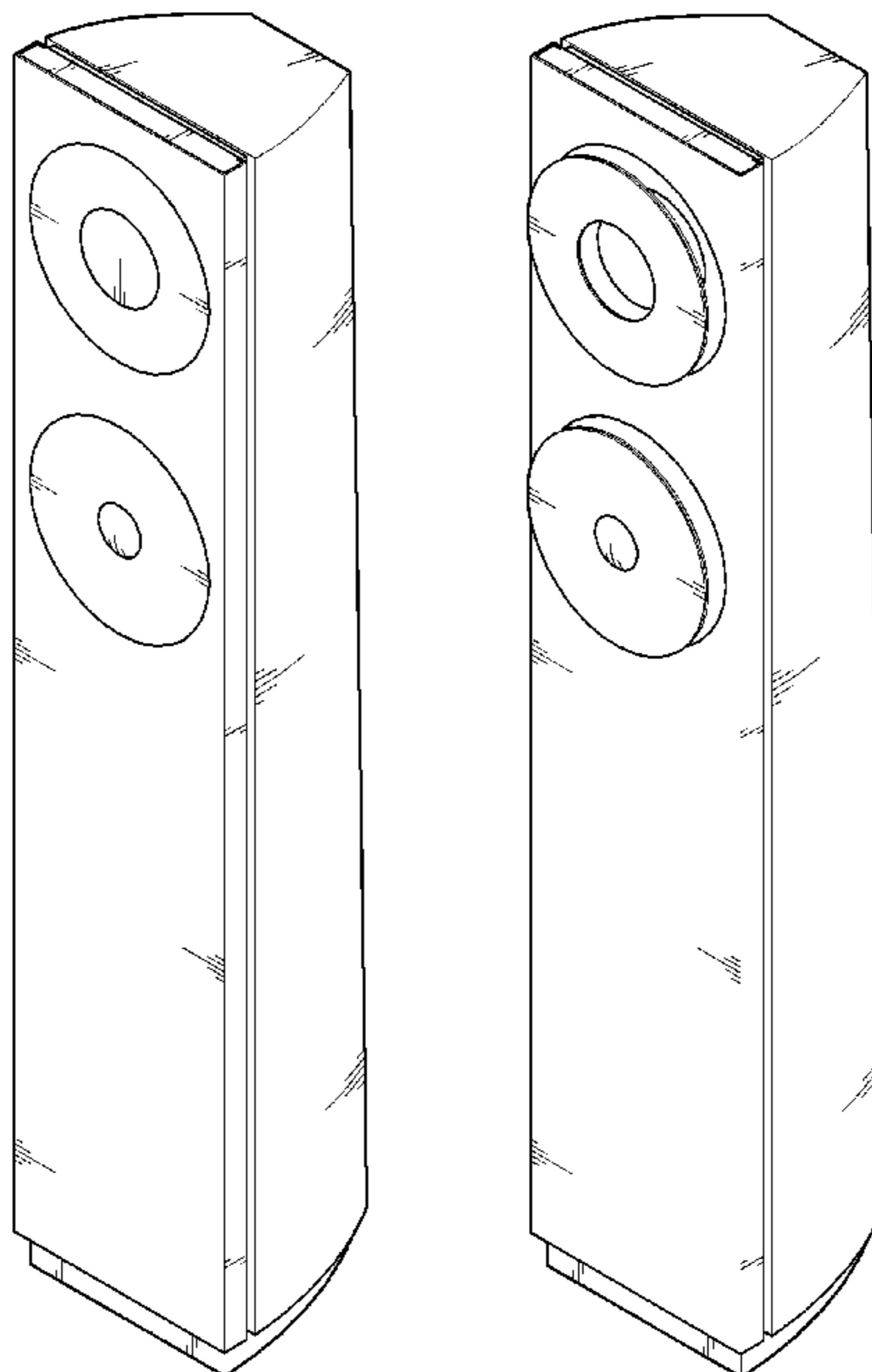

FIG. 1

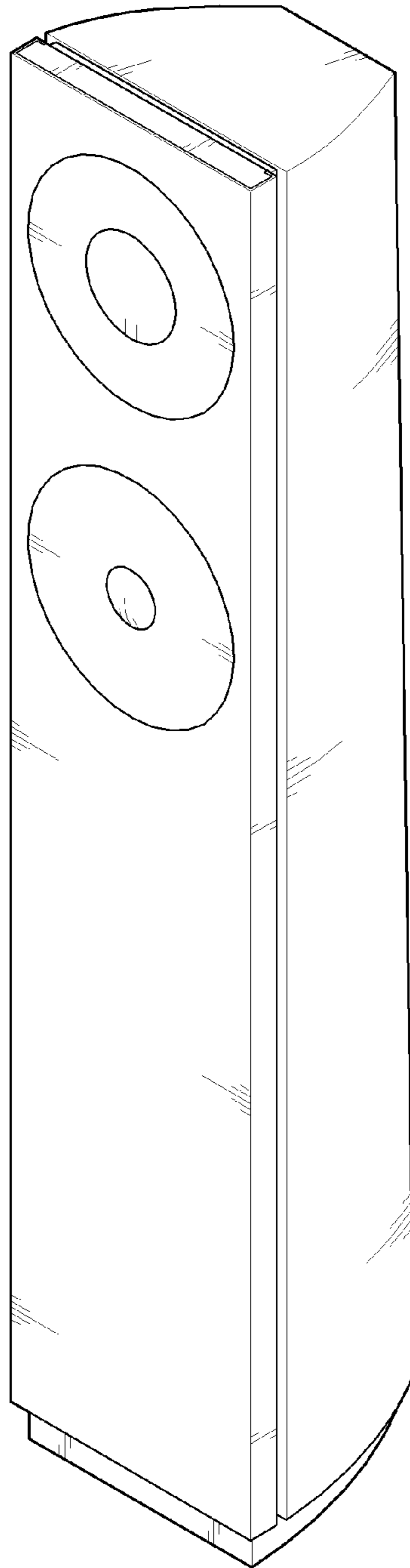

FIG. 2

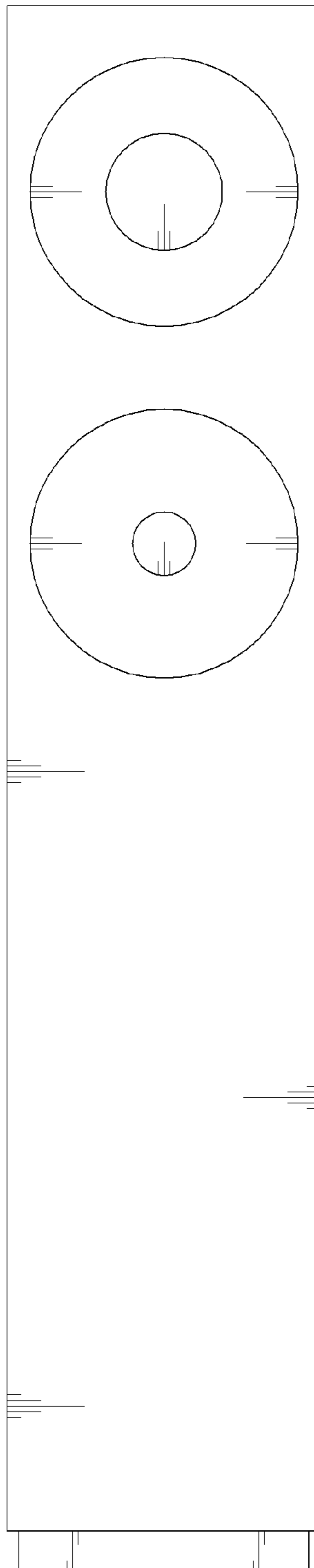

FIG. 3

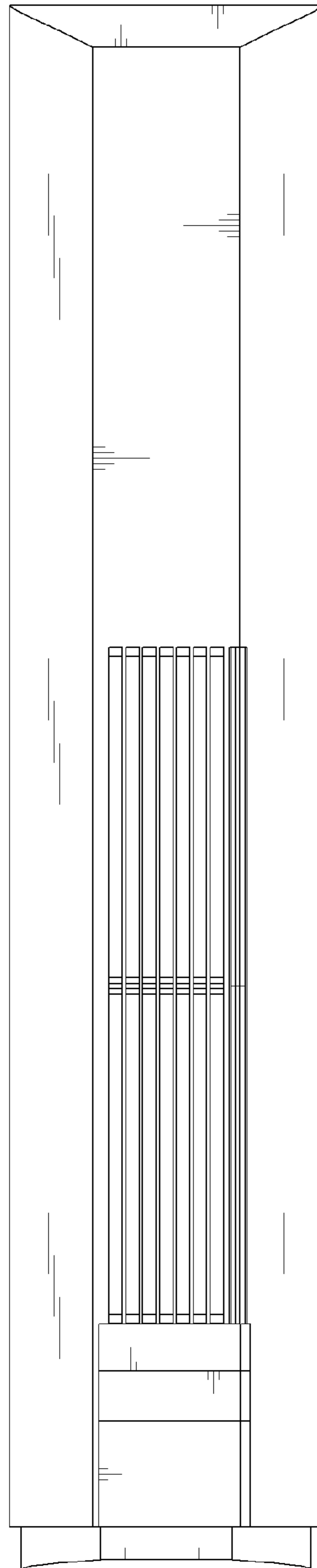

FIG. 4

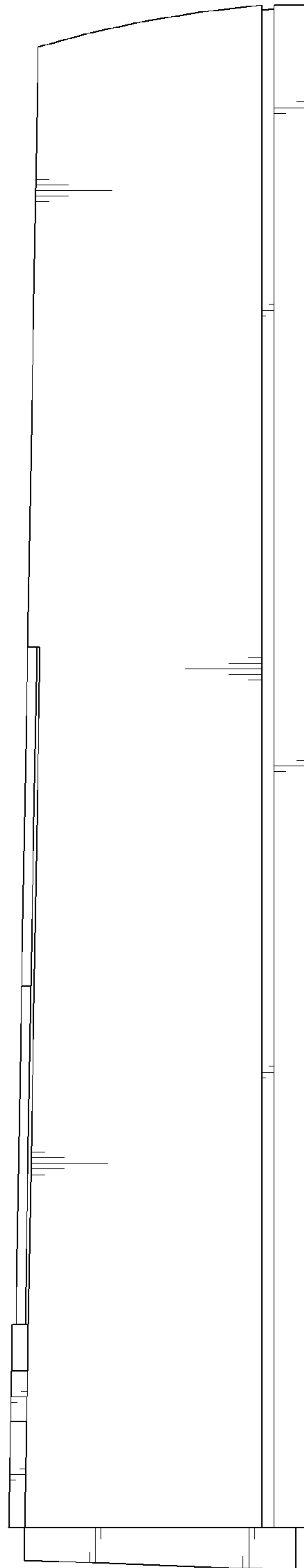

FIG. 5

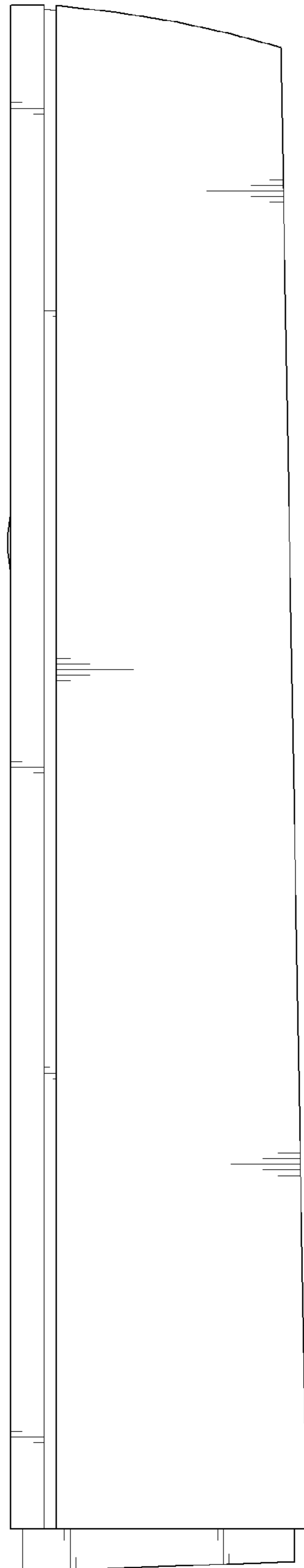

FIG. 6

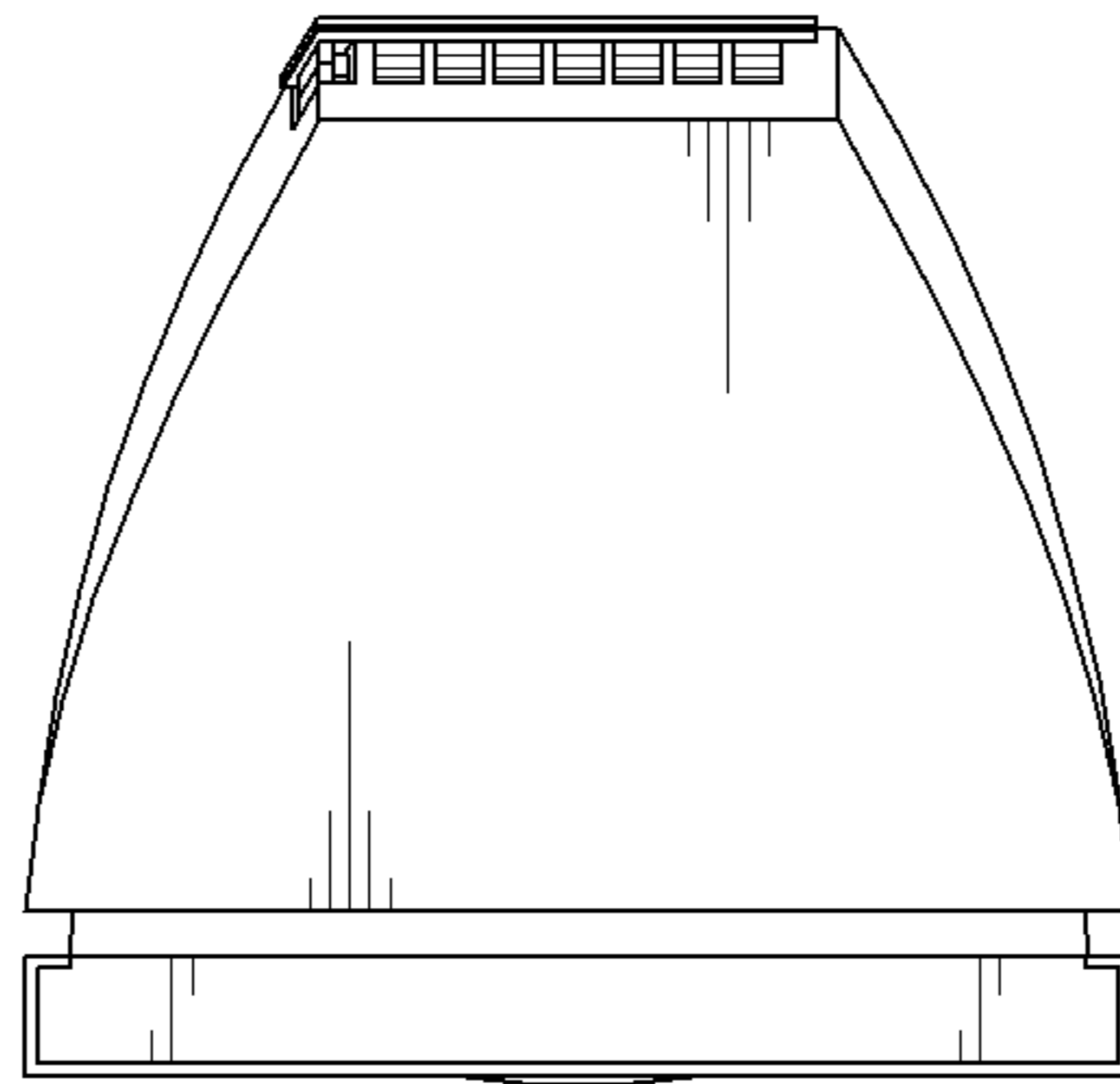

FIG. 7

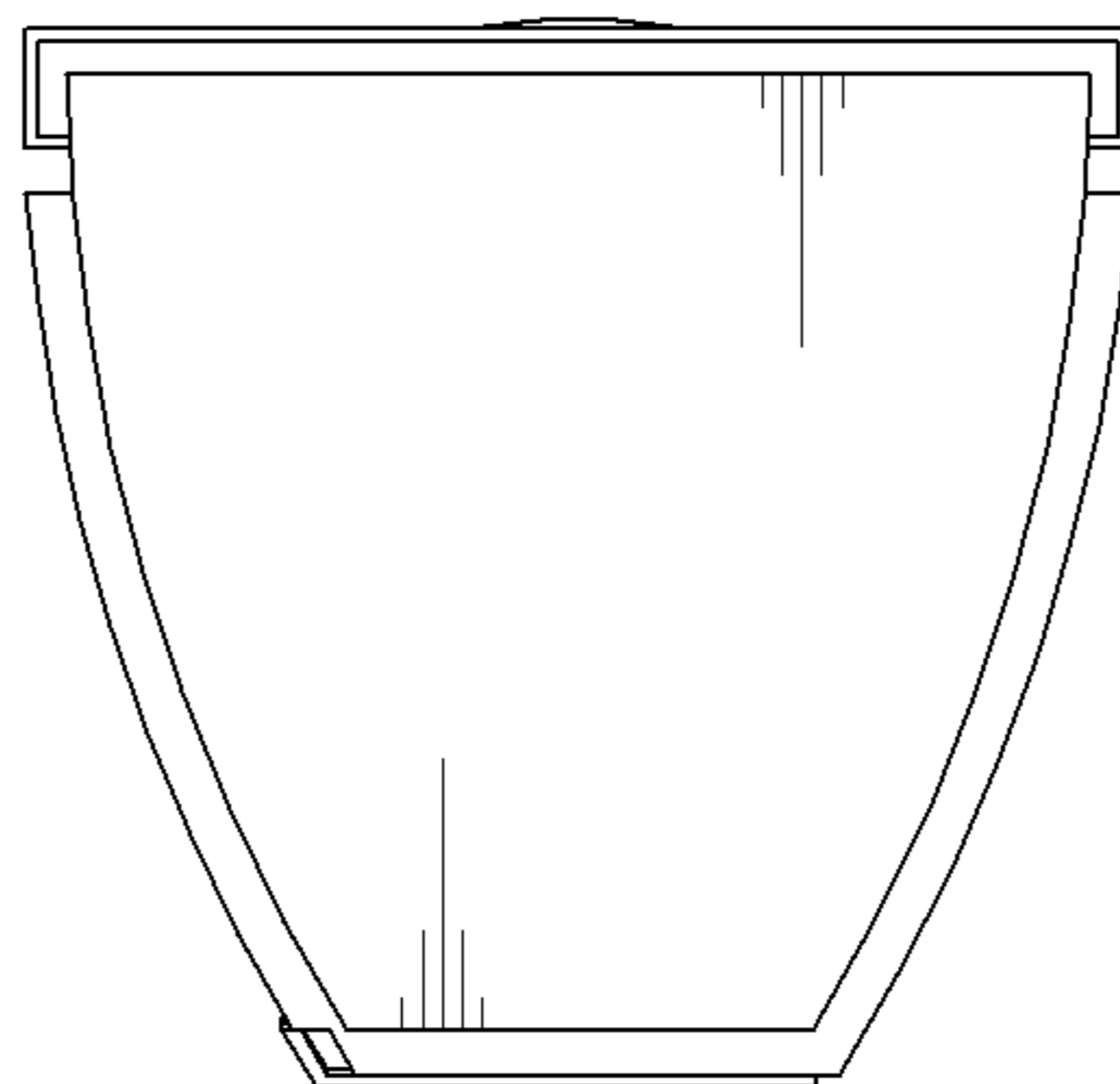

FIG. 8

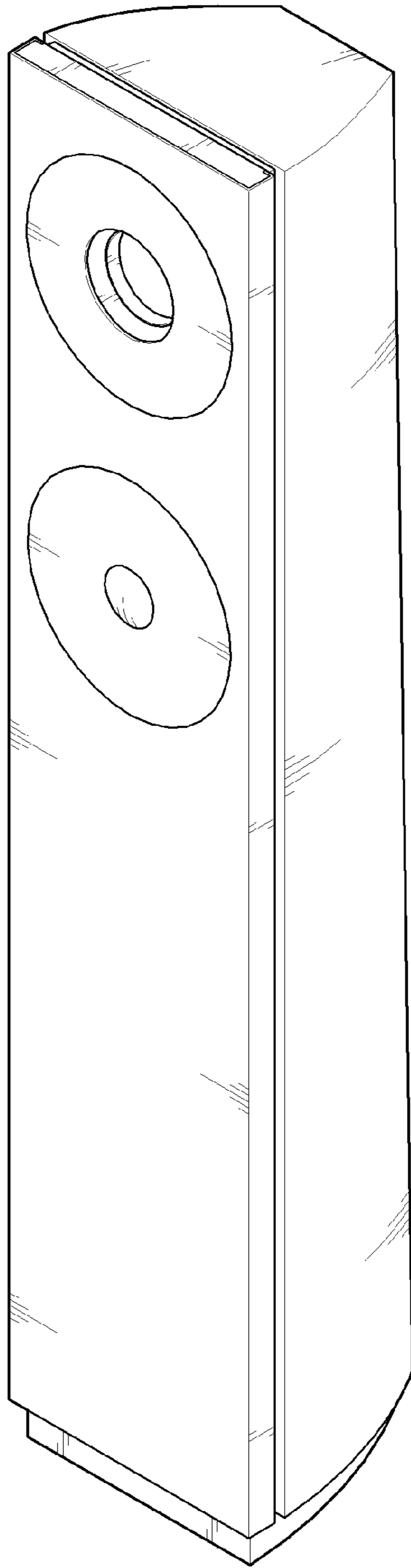

FIG. 9

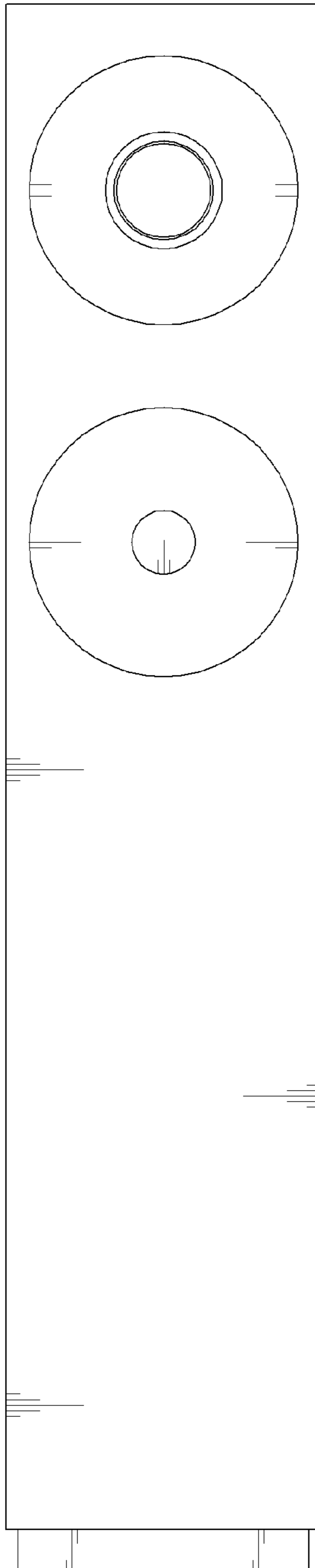

FIG. 10

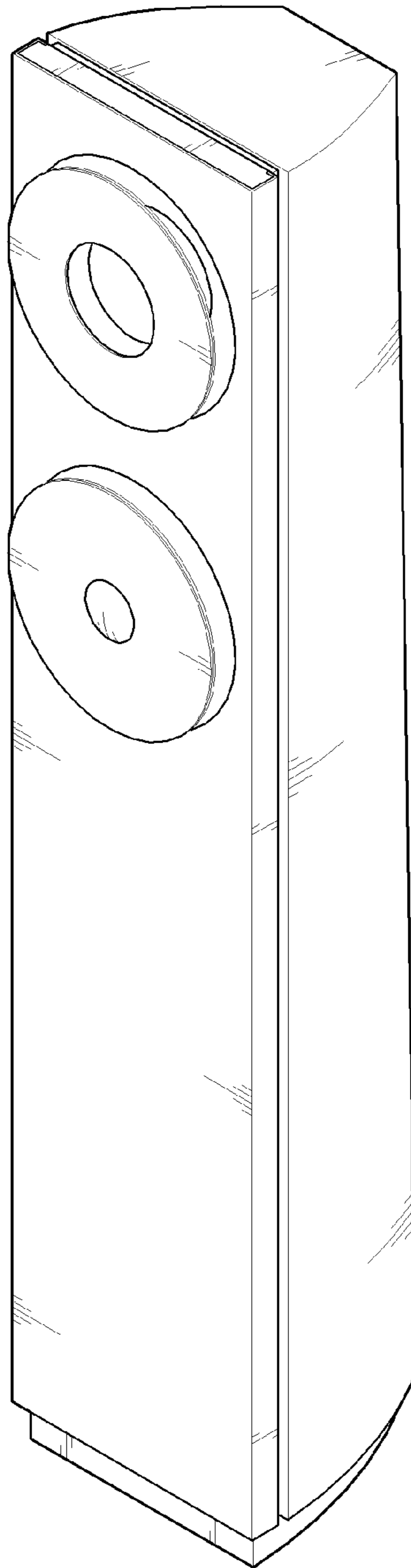

FIG. 11

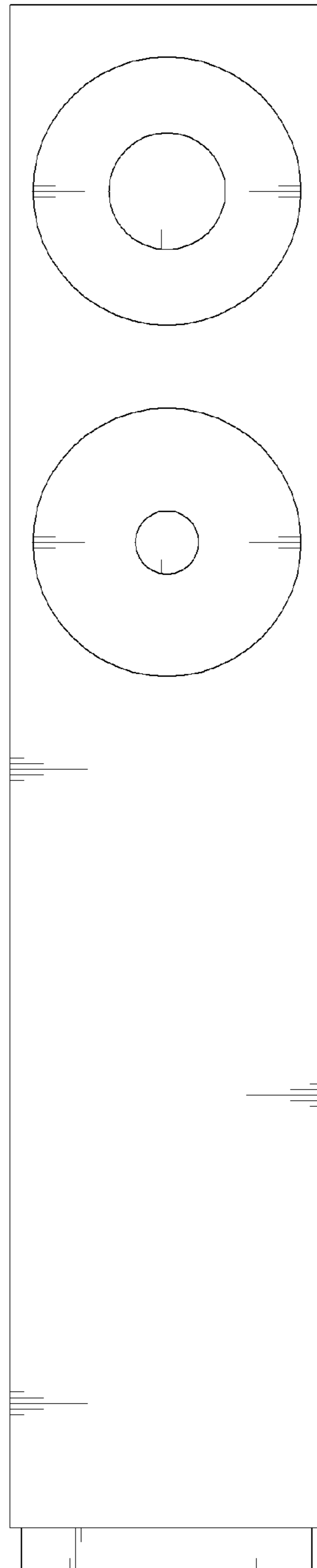

FIG. 12

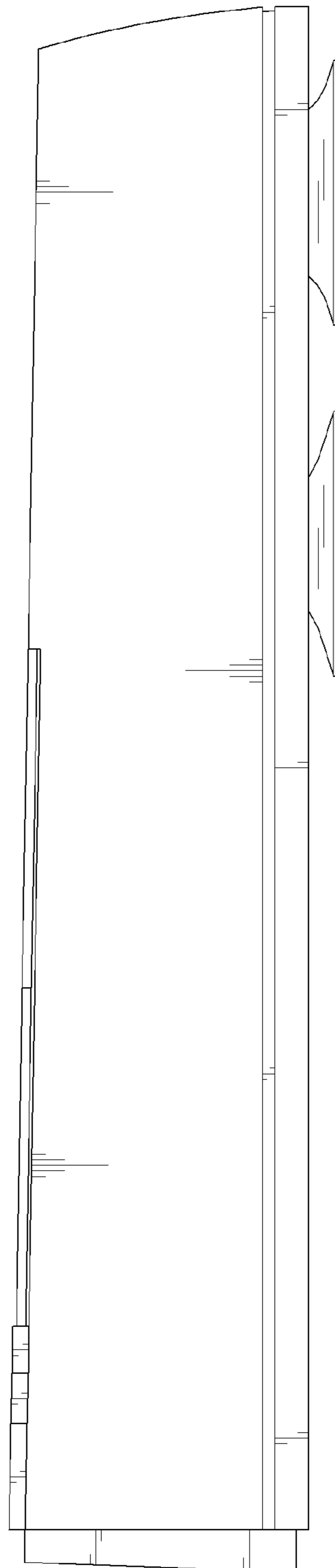

FIG. 13

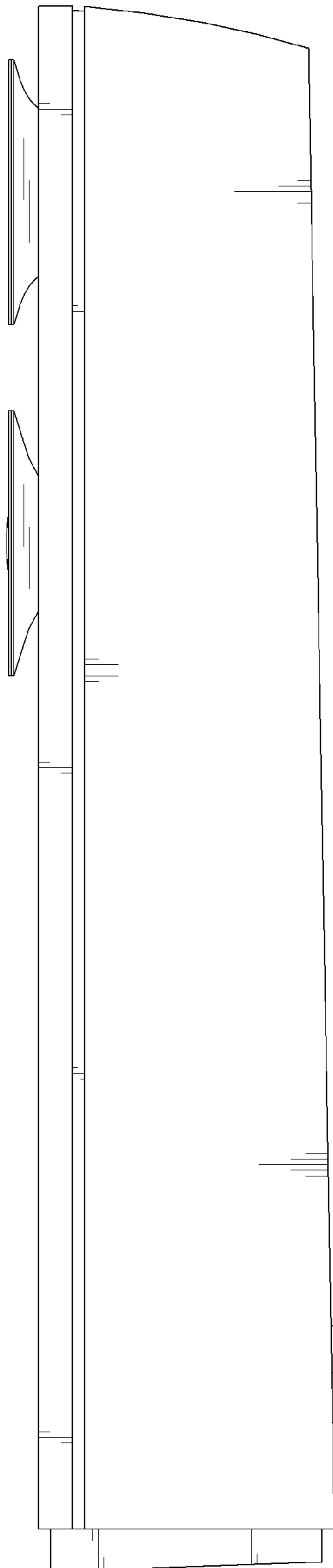

FIG. 14

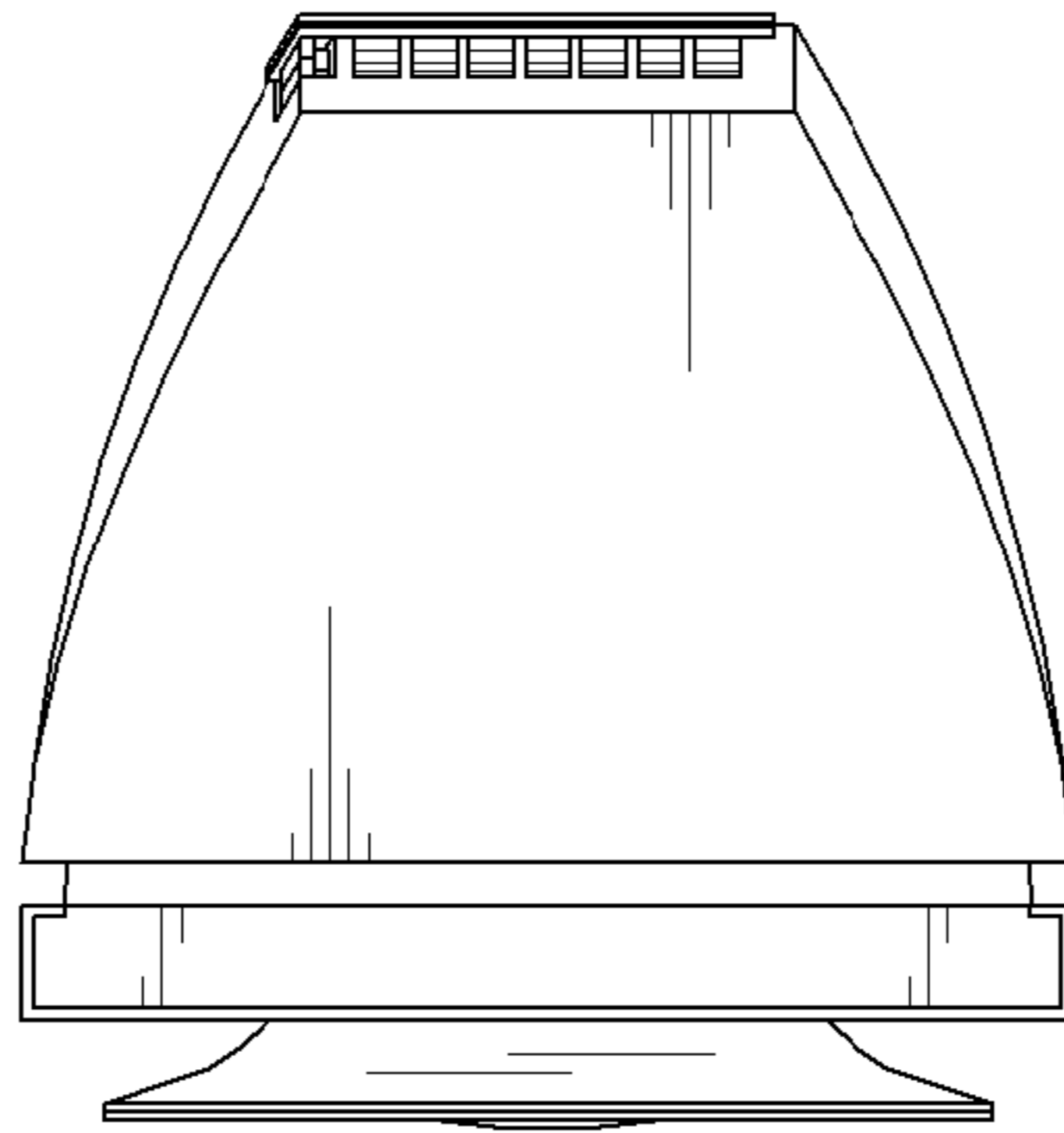

FIG. 15

